

CAST IRON SQUARE FLOOR SINK - ARE

861 SERIES

SPECIFICATION

Sioux Chief 861 Series 8" x 8" x 6" deep floor sink. Cast iron body and anchor flange with white acid-resisting enamel coated interior and top, includes aluminum dome strainer.

Designed in accordance with ASME A112.6.7

Used in kitchens, restaurants, grocery stores, hospitals, schools and other areas that require a sanitary drain.

MATERIALS

Grate: Enamel-coated cast iron, nickel-bronze, 304 stainless steel

Sink: Enamel-coated cast iron

DIMENSIONS

A: Connection (No-Hub) 2" 3" 4"

ITEM # SUBMITTED	_____
JOB NAME	_____
LOCATION	_____
ENGINEER	_____
CONTRACTOR	_____
PO#	_____ TAG _____



861-QF2386

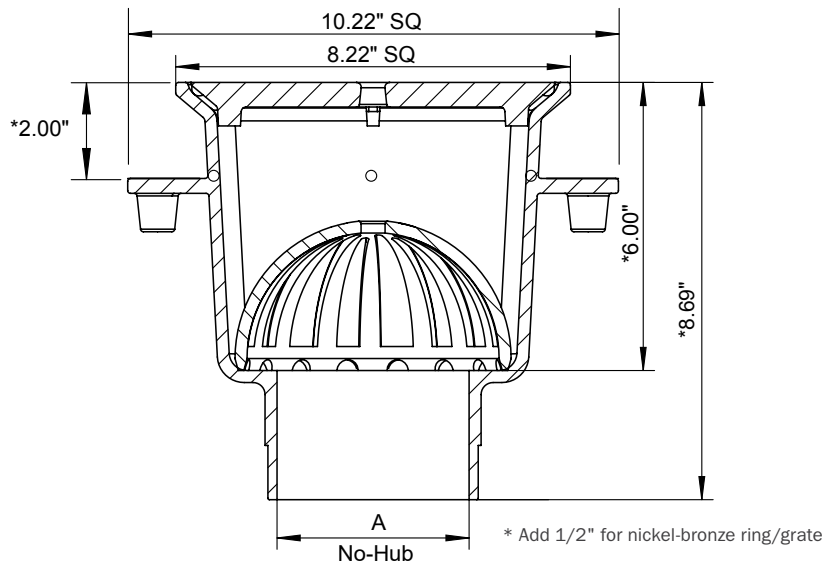

Create Item Number

861-A B C

e.g. **861-QF2386A2C:** 3" No-Hub floor sink with open-half enamel-coated cast iron grate and clamping collar

CONNECTION SIZE **A**

QF2286 = 2" No-Hub

QF2386 = 3" No-Hub

QF2486 = 4" No-Hub

GRATE TYPE **B**

No grate (standard)

A = enamel-coated cast iron grate

N = Nickel-bronze frame/grate

S = Stainless steel frame/grate

OPTIONS **C**

2 = Open-half grate

3 = Open-quarter grate

B = Aluminum Debris bucket

C = Clamping collar

T = Trap primer adapter