

OmniPanel™

Dual-Valve Access Panel

Patent # 9,057,460 B2

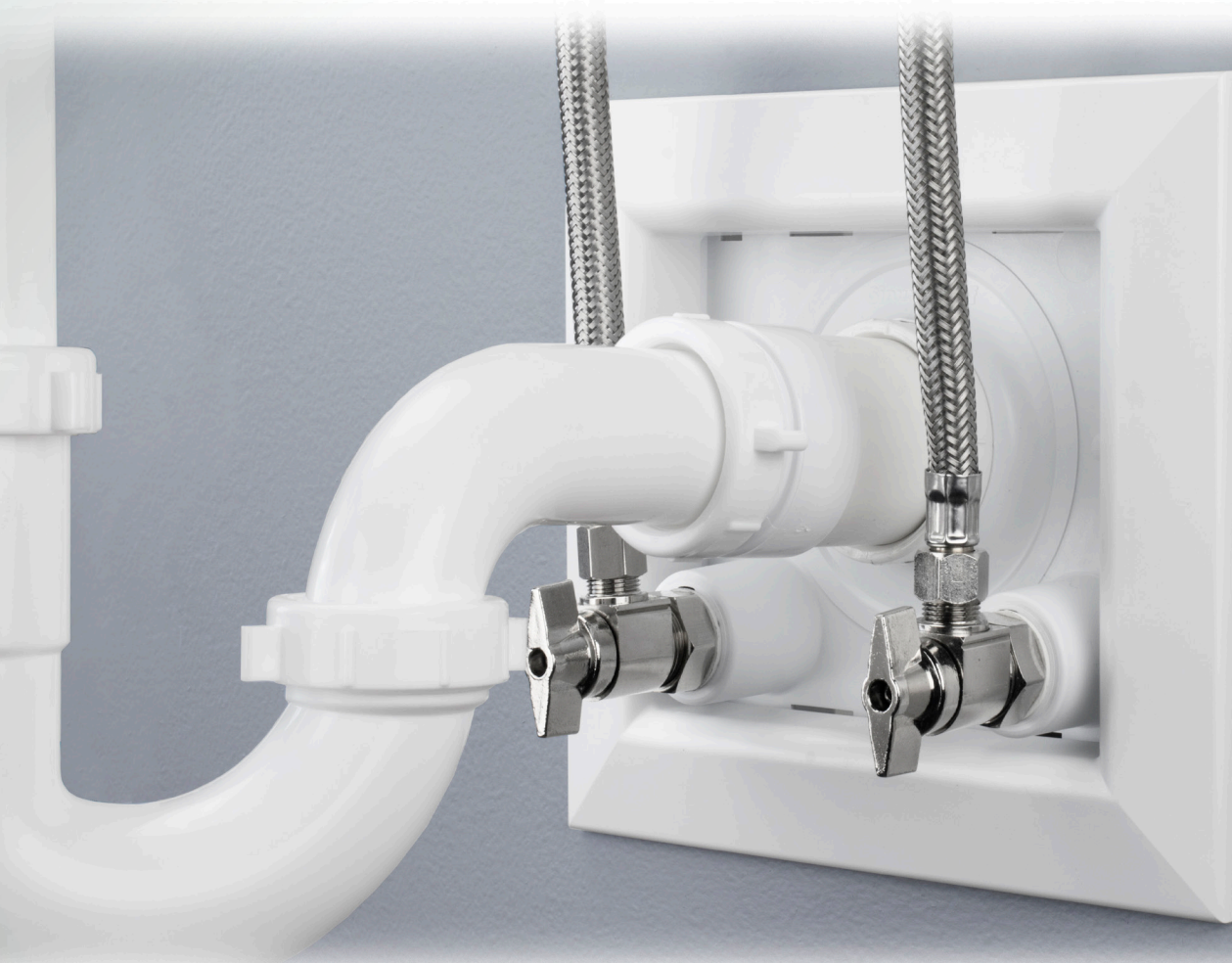

Fewer Touches

Valves are installed at rough, keeping them on test throughout the job, no drain down.

Savings

Saves time with every installation.

No more separate parts and pieces – Multiple components are replaced by one easy-to-install product.

Standardized

Installations are consistent – Clean, solid and professional.
Valves are replaceable with standard 5/8" OD supply stops.



Supply

Drainage

Support

Specialties

www.siouxchief.com

TAKE THE FIELD.



Recommended Installation

Supply Valves
Below Drainage

Strong



Engineered, reinforced material provides a solid foundation for permanent valve installation.

Convenient

Versatile mounting options. Fasten directly to stud or position between studs using brackets provided.

Universal



No need to tear into drywall. Valves are easily accessible from the finish side of the wall and can be replaced with ANY standard 5/8" OD compression stop valve

Lavatory



Pre-colored white material provides clean, consistent looks. Matching frames and extensions available.

Laundry



Works perfectly as a laundry supply panel. Use a flush-facing 2" DWV elbow for drain hose



Patented Elastomer

Flexible port seals around drainage arm. Accommodates penetrations from 1½" pipe to 2" DWV fitting hub.



Installs On or Between Studs

Set screw through panel to lock into place

Protected



OmniPanel™ installs securely at rough-in. Valve caps, debris cover, and best-in-class materials protect installations during construction and over lifetime of the system.



All valves include nylon, hex test caps
No dropped tests. Resists tampering by other trades during construction.

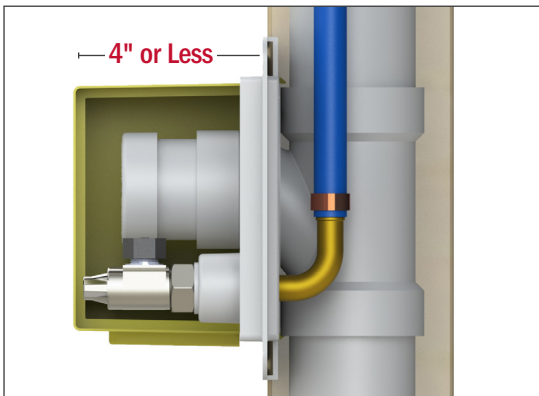

Drainage arm rough-in should be no longer than 4" to fit under the debris cover.



Use zip-ties (included) to keep debris cover in place. Keeps valves (and your pressure test) protected.

Patented Valve Design Exclusive to Sioux Chief Access products.

Patent # 9,725,892 B2

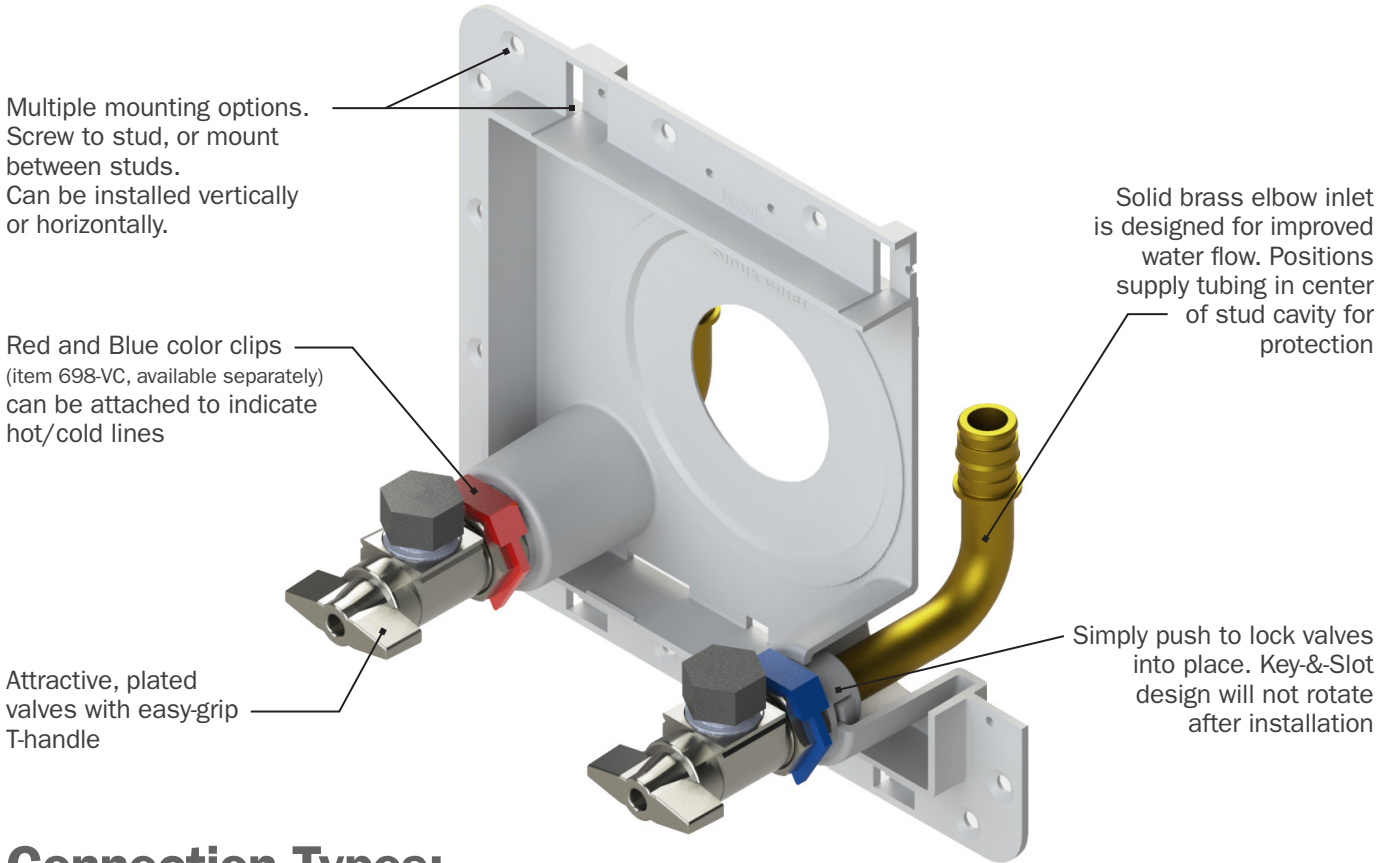

Connection Types:

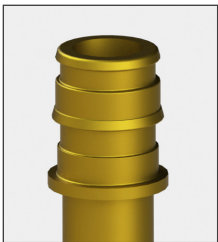

ASTM F1960 Grip™

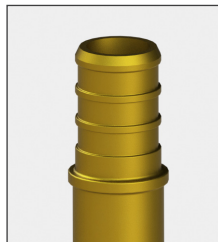

ASTM F1807 Crimp™

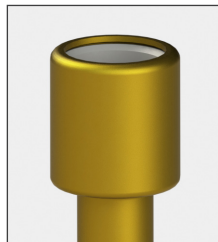

CPVC Socket

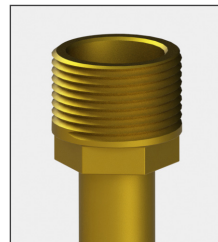

MIP/F.SWT

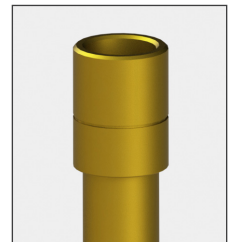

M.SWT/Push/Press with push-fitting lock groove

Valve Options:



Optional MiniRestor™ provides code-required protection for appliances with quick-closing valves

Quality





Valves and connection elbows are made from C69300 brass; the **Best Material Available** for protection against dezincification and stress-corrosion cracking

Complete Rough-In Package

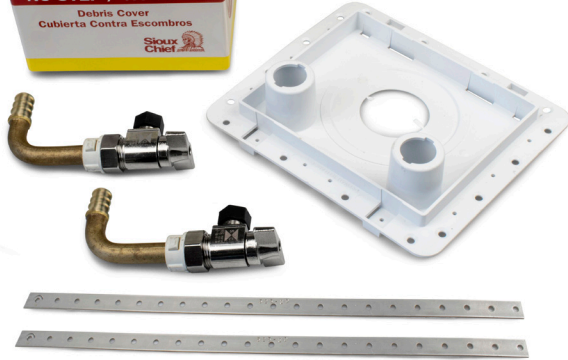

The OmniPanel™ includes everything you need, when you need it: a sturdy mounting/access plate, brackets, high-quality valves with brass elbow connection, and durable, protective debris cover.



Finish frames are available separately, keeping them OFF the job (not lost, not damaged) until finish

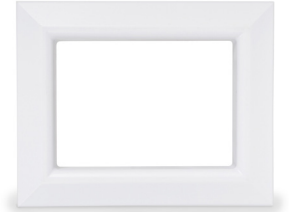

Flexible Drainage Port

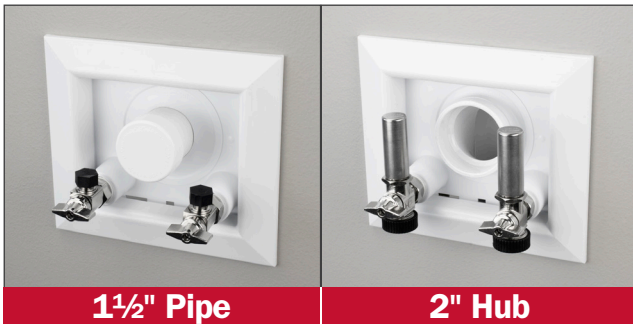

The OmniPanel™ features an integral, elastomeric center port, which will accommodate 1 1/2" pipe/hub and will even wrap over a 2" Sch. 40 fitting hub.

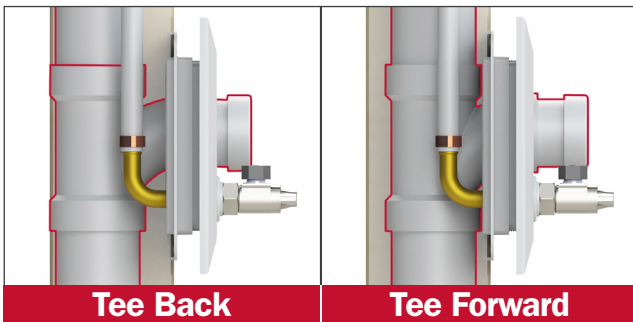

The flexible material can be installed over drain pipe or fitting hub, when tee is in FRONT or BACK of stud cavity.



Even if the drainage arm is angled sharply, as for a corner sink, the port maintains a sealed penetration – and the panel remains flush and square, making the finish faster, easier, and cleaner.

Lavatory Application



Quickly and easily set rough-ins for any lavatory. Pre-colored white panel and color-matched frame provides a professional-looking installation on every job.

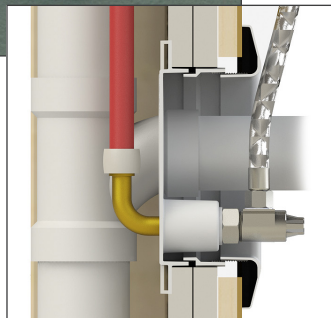

Valves Below Drainage

Recommended Installation

Although the OmniPanel™ can be installed in any position, the recommended installation is with the valves on the bottom-side of the panel - below the drainage port.

This orientation ensures the supply lines can flex out and connect easily to the fixture

Additional Features

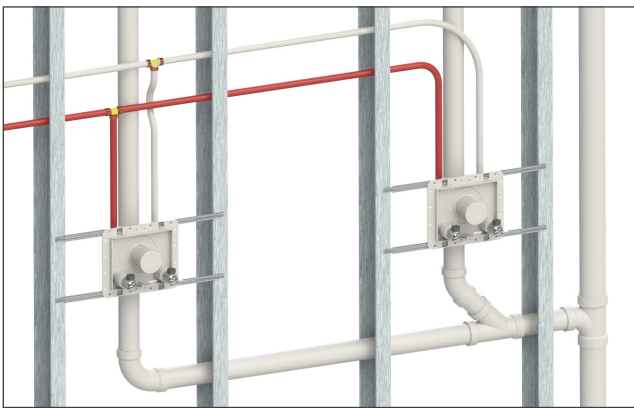

Consistent Commercial Rough-ins

The OmniPanel™ is perfect for installing multiple lavatories in series – in commercial applications or for side-by-side vanities.

Supply lines can be run from above or below. Optional water hammer arresters install at any angle



Replaceable Valve Design

Valves can be replaced with any standard 5/8" OD compression-thread valve.

Replacements can be done completely from the finish side of the wall - no need to tear into the drywall. (see website for valve replacement instructions)

Laundry Application



The OmniPanel™ is a perfect alternative to traditional laundry boxes. Laundry drain hose installs directly into a flush-facing 2" Sch. 40 elbow.

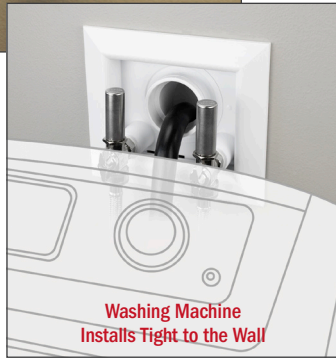

Smaller Gap Needed

The low-profile design directs laundry supply hose connections down rather than out, allowing washing machines to be set closer to the wall.



Valve Versatility

The valve outlet can be oriented in any direction, independent of the inlet elbow. For applications where multiple layers of drywall are used, and valves are set above drainage in a lavatory installation, extended replacement valves are available.



Extended replacement valves are available
688-G1CE



Frames / Extensions

Frames are designed to snap onto the plate and hold securely – Perfect for interior walls. For rated walls or where cabinets are used with multiple layers of drywall, frame extensions (698-EX) are available to accommodate any installation.



698-A11-WR



688-G1CE



698-F



698-EX

Buying Information

ITEM NO.	FIRE-RATED ITEM NO.	DESCRIPTION	MIN. QTY.	CASE QTY.
OMNIPANEL™ WITH 3/8" OD COMP. OUTLET VALVE				
698-A11-CR	698RA11-CR	1/2" CPVC socket connection	10	10
698-A11-MR	698RA11-MR	1/2" MIP/F.Swt connection	10	10
698-A11-PR	698RA11-PR	1/2" M.Swt connection - Press/Push compatible	10	10
698-A11-VR	698RA11-VR	1/2" F3347 PEX connection	10	10
698-A11-WR	698RA11-WR	1/2" F1960 PEX connection	10	10
698-A11-XR	698RA11-XR	1/2" F1807 PEX connection	10	10
698-A11APR	698RA11APR	1/2" M.Swt connection - Press/Push compatible with arresters	10	10
698-A11AWR	698RA11AWR	1/2" F1960 PEX connection with arresters	10	10
698-A11AXR	698RA11AXR	1/2" F1807 PEX connection with arresters	10	10
OMNIPANEL™ WITH 3/4" MALE HOSE THREAD OUTLET VALVE				
698-A33-CR	698RA33-CR	1/2" CPVC socket connection	10	10
698-A33-MR	698RA33-MR	1/2" MIP/F.Swt connection	10	10
698-A33-PR	698RA33-PR	1/2" M.Swt connection - Press/Push compatible	10	10
698-A33-WR	698RA33-WR	1/2" F1960 PEX connection	10	10
698-A33-XR	698RA33-XR	1/2" F1807 PEX connection	10	10
698-A33ACR	698RA33ACR	1/2" CPVC socket connection with arresters	10	10
698-A33AMR	698RA33AMR	1/2" MIP/F.Swt connection with arresters	10	10
698-A33APR	698RA33APR	1/2" M.Swt connection - Press/Push compatible with arresters	10	10
698-A33AWR	698RA33AWR	1/2" F1960 PEX connection with arresters	10	10
698-A33AXR	698RA33AXR	1/2" F1807 PEX connection with arresters	10	10
ACCESSORIES				
698-DC		Debris cover for OmniPanel	24	24
698-EX		Frame extension for OmniPanel	10	10
698-F		Frame only for OmniPanel	10	10
698RF		Finish Kit - Includes Fire-Rated Frame, Hole-Insert Strips, And Frame Extension	1	10
698-VC		Color clips for valve - red/blue	50	50
688-G1CE		Extended replacement valve - 5/8" OD comp. thread x 3/8" OD comp. outlet	1	10
305-RT		Grommet removal tool - use to remove valve from base plate	1	10

