

# Sioux Chief

MANUFACTURING SINCE 1957



**Product Catalog**

**Edition 32.9**

Effective: Sep 9, 2024

Prices Supersede All Previous Editions



## **Sioux Chief is an American Manufacturer**

Sioux Chief is a leading American manufacturer of rough plumbing products located in Kansas City, Missouri. We develop and manufacture some of the most diverse and innovative plumbing products in the country.

We focus on product innovation initiated by field research and interviews with plumbers, engineers, code officials and distributors. We're able to turn ideas into products quickly because we design and build our own machines. This also allows us to control manufacturing costs and minimize down-time, providing consistent, reliable value to our customers.

Our primary purpose as an American manufacturer is to provide better value to the professional plumbing and mechanical contractor by offering top-quality, innovative products with superior customer service. Our goal as an American innovator, is to make plumbing installation easier, more effective, and more efficient.

We strive every day to meet the demands of the rough plumbing industry with innovation, quality, and the American spirit.

# Catalog Edition 32.9

<b>Supply</b>	<b>Drainage</b>	<b>Support</b>	<b>Specialties</b>
<b>PowerPex® Systems</b>	<b>Specification Drainage</b>	<b>Supply Hangers</b>	<b>Tubular</b>
PowerPex® Tube 11	Floor Drains 245	Plastic CTS 485	Plastic Tubular 563
F1807 Systems 17	Floor Sinks 273	Metal CTS/IPS 495	Metal Tubular 575
F2159 Systems 43	Roof Drains 283	Anchors & Fasteners 499	Basket Strainers & Sink Drains 593
F1960 Systems 49	Cleanouts 297	<b>DWV Hangers</b>	Bath Waste Drains 601
F3347 Systems 71	Fixture Carriers 315	Extension Hangers 505	<b>Plumbing Specialties</b>
<b>Specialized Supply</b>	<b>Commercial Drainage</b>	Hanger Straps 509	Supply Stops & Kits 609
CPVC Systems 79	Floor Drains 328	Ground Stakes 513	Supply Tubes 617
Sch 40 CPVC 91	Floor Sinks 355	<b>Brackets</b>	Lav/Sink Specialties 621
PVC Systems 95	Roof Drains 363	Stub Out Brackets 519	Closet Specialties 631
Sweat/Copper 101	Cleanouts 369	Bend Supports 525	Tub/Shower Specialties 639
PDQ™ Push Fittings 123	<b>Trench Drains</b>	Universal Brackets 529	<b>Tubing &amp; Hose</b>
Pipe Insulation 135	FastTrack™ System 388	Adjustable/Multi-Purpose Brackets 533	Vinyl Tubing 648
<b>Arresters &amp; Trap Primers</b>	HydroTec™ System 394	Commercial Brackets 537	Polyethylene Tubing 653
Arresters 141	HydroBlock™ System 405	Overhead 545	Hose 657
Trap Primers 149	HydroLine™ System 409	Stud Guards & Safety Plates 551	Fuel Line 661
<b>Access</b>	<b>Residential Drainage</b>	Water Heater Accessories 555	Gasket Material 665
Laundry Boxes 157	Shower Drains 415	<b>Tubing/Hose Fittings</b>	Fittings 671
Ice Maker Boxes 165	Residential Floor Drains 433	<b>Tools &amp; Chemicals</b>	PowerPex® Tools 757
Toilet/Dishwasher Boxes 169	Closet Flanges 443	Tools & Accessories 761	Brushes & Abrasives 771
Lav Boxes 173	Backwater Valves 453	Sealants, Lubricants, & Tapes 775	Chemicals 779
Kitchen Supply Boxes 179	Air Admittance Valves 457		
Water Service Boxes 183	Residential Accessories 461		
Gas Service 207	<b>Testing</b>		
Air-Admittance Boxes 211	Test Devices 467		
Outlet Box Accessories 215	Gauges & Accessories 477		
Panels 221			

Items in buying tables with BOLD type are non-stock items.  
Extended lead times may apply to non-stock items.

For Drainage items having one or more listed option, Buyer will be charged 33% of the applicable return price for product restocking; and will apply to canceled orders that have been entered but not shipped.



### **Making it in America – Since 1957**

American manufacturing generates almost 11% of the U.S. gross domestic product. It accounts for 60% of our exports and employs nearly 12 million people. 70% of U.S. dollars spent on research and development come from the manufacturing sector.

Sioux Chief manufactures more than 90% of the products we sell, employing more than 500 American workers in the process. We design, build and maintain all of our own copper tube forming tools, machines, plastic injection molds, packaging, cleaning and testing equipment as we produce the highest quality American-made plumbing parts.

Buy American when you can. We all succeed when you do!

# Supply

**PowerPEX® Systems**

**Specialized Supply**

**Supply Accessories**

**Arresters &  
Trap Primers**

**Access**

**»» Making it in America**

## **A Brief Explanation of Terms Used in the Supply Section:**

**CTS:** All Copper, CPVC, and PEX fitting sizes in this section refer to CTS (Copper Tube Size) unless otherwise specified. The CTS size (or "Nominal" size) is the common size reference. However, compression connections are commonly referred to by the "OD" of the tube that they fit (e.g., 1/2" CTS copper tube fits in a 5/8" OD Compression fitting). In these cases, the term "OD" will always be shown with the size.

**F1807:** We use this designation to indicate a PEX connection that conforms to the ASTM F1807 standard. Typically, F1807 fitting ends are made from copper or brass, and joints can be made with copper crimp rings, the V-Sleeve compression sleeve, or stainless steel cinch clamps.

**F2159:** We use this designation to indicate a PEX connection that conforms to the ASTM F2159 standard. F2159 fittings are made from an engineered polymer (such as PPSU), and joints can be made with copper crimp rings, the V-Sleeve compression sleeve, or stainless steel cinch clamps.

**F1960:** Sometimes referred to as "Wirsbo<sup>®</sup>," we use this designation to indicate a PEX connection that conforms to the ASTM F1960 standard. F1960 fitting ends can be made from brass or an engineered polymer. Joints are made with PEX expansion rings.

*Wirsbo<sup>®</sup> is a registered trademark of Uponor Corporation*

**F3347:** Sometimes referred to as "Viega<sup>®</sup>," we use this designation to indicate a PEX connection that conforms to the ASTM F3347 standard. F3347 fitting ends are typically made from brass, and joints are made with a stainless steel compression sleeve.

*Viega<sup>®</sup> is a registered trademark of Viega LLC.*

**FIP Swivel:** Female Iron Pipe - Unlike the MIP Swivel, the FIP Swivel has straight (NPS) threads, and utilizes a gasket seal. Pipe dope/sealants should not be used for these connections.

**Full-Port:** Ball valves that are designated as Full-Port have an opening through the ball that is as large or larger than the ID of the connecting tube.

**MIP Swivel:** Male Iron Pipe - Like standard MIP adapters, MIP swivel threads are tapered (NPT), but the adapter swivels, making it easier for installation and alignment of the fitting. Thread sealants are used on these connections.

**MSWT / FSWT:** We use these designations to indicate Male Sweat and Female Sweat copper fittings. A MSWT fitting end is the same as plain copper tube of the same size.

**NL/DZR:** This is used to designate fittings as being made from brass material that is No-Lead compliant\* (NL) and dezincification resistant (DZR).

*\* Complies with NSF-61 & 372 and California No Lead Plumbing Law*

**PPSU / PSU:** An engineered polymer that was developed for use in potable water systems and has been used for more than 20 years.

**SCC:** Stress-corrosion cracking - a type of cracking that can occur in some metals, caused by the combination of tensile stress and a corrosive environment.

**Spun Closed:** A process used extensively by Sioux Chief for mechanically sealing the end of copper tube, resulting in a signature 'bullet' shape.

# **PowerPEX<sup>®</sup> Systems**

**PowerPEX<sup>®</sup> Tube**

**for ASTM F1807**

**for ASTM F2159**

**for ASTM F1960**

**for ASTM F3347**

# PowerPEX<sup>®</sup> Systems

## PowerPEX<sup>®</sup> Tube

**ASTM F876:** Standard Specification for Cross-linked Polyethylene (PEX) Tubing

**ASTM F877:** Standard Specification for Cross-linked Polyethylene (PEX) Hot and Cold-Water Distribution Systems

**CSA B137.5:** Cross-linked Polyethylene (PEX) Tubing Systems for Pressure Applications

## ASTM F1807 | F2159 Crimp<sup>™</sup>



*Standard Specification for Metal<sup>1</sup> or Plastic<sup>2</sup> Insert Fittings Utilizing a Copper Crimp Ring, or Alternate Stainless Steel Clamps, for SDR9 Cross-linked Polyethylene (PEX) Tubing and SDR9 Polyethylene of Raised Temperature (PE-RT) Tubing*

1 = ASTM F1807 2 = ASTM F2159

## ASTM F1960 Grip<sup>™</sup>



*Standard Specification for Cold Expansion Fittings with PEX Reinforcing Rings for Use with Cross-linked Polyethylene (PEX) and Polyethylene of Raised Temperature (PE-RT) Tubing*

## ASTM F3347



*Standard Specification for Metal Press Insert Fittings with Factory Assembled Stainless Steel Press Sleeve for SDR9 Cross-linked Polyethylene (PEX) Tubing and SDR9 Polyethylene of Raised Temperature (PE-RT) Tubing*

### PowerPEX = The Power to Choose

The ability to choose the right tube or fitting connection for each application, layout or contractor comfort level. We call this Fitting Freedom<sup>™</sup>. Sioux Chief understands smart plumbing systems may incorporate “hybrid” PEX offerings to maximize each connection system's benefit. The Power to Choose puts the plumber back at the heart of smart plumbing.





# PowerPEX<sup>®</sup> Tube

**Type-B PEX Tube - Sticks & Coils**

**Type-A PEX Tube - Sticks & Coils**

Sioux Chief PowerPEX<sup>®</sup> tube is ideally suited for water distribution. Common applications include: water service/distribution, radiant heating/cooling, snow-melt systems, fire suppression, geothermal, etc.

**Note:** Special system component considerations must be made for radiant or snow melt systems when using non-barrier tubing.

All expansion joints made using PowerPEX Type-B tubing **MUST** be made with a self-rotating, power expansion tool to eliminate weak spots and avoid improper expansion rates.

Refer to Sioux Chief's PowerPEX Installation Manual for full restrictions and details.

Always check with local codes and applicable requirements.





**664X2W10**  
Page 11



**665X3R100**  
Page 11



**665X2W500**  
Page 12



**665X2R1000**  
Page 12



**665X2H500**  
Page 13



**664XA5W20**  
Page



**665XA2N500**  
Page 13



**665XA3N100H**  
Page



**305-X665**  
Page 14

## Lead-Free Compliant



Products made from 'Copper' or 'NL/DZR' material comply with NSF-61 & 372 and with the California No Lead Plumbing Law.

## Type B PEX Tube

### Sticks

Item Number	Item Description	Pkg Type	Min Qty	Case Qty	Price
<b>10' STICKS</b>					
664X2B10	1/2" Blue, 50/Bag	B	1	1	\$265.00
664X2R10	1/2" Red, 50/Bag	B	1	1	\$265.00
664X2W10	1/2" White, 50/Bag	B	1	1	\$265.00
664X3B10	3/4" Blue, 25/Bag	B	1	1	\$242.50
664X3R10	3/4" Red, 25/Bag	B	1	1	\$242.50
664X3W10	3/4" White, 25/Bag	B	1	1	\$242.50
664X4B10	1" Blue, 15/Bag	B	1	1	\$265.50
664X4R10	1" Red, 15/Bag	B	1	1	\$265.50
664X4W10	1" White, 15/Bag	B	1	1	\$265.50
<b>20' STICKS</b>					
664X2B20	1/2" Blue, 50/Bag	B	1	1	\$530.00
664X2R20	1/2" Red, 50/Bag	B	1	1	\$530.00
664X2W20	1/2" White, 50/Bag	B	1	1	\$530.00
664X3B20	3/4" Blue, 25/Bag	B	1	1	\$485.00
664X3R20	3/4" Red, 25/Bag	B	1	1	\$485.00
664X3W20	3/4" White, 25/Bag	B	1	1	\$485.00
664X4B20	1" Blue, 15/Bag	B	1	1	\$531.00
664X4R20	1" Red, 15/Bag	B	1	1	\$531.00
664X4W20	1" White, 15/Bag	B	1	1	\$531.00
664X5W20	1-1/4" White, 10/Bag	B	1	1	\$840.00
664X6W20	1-1/2" White, 8/Bag	B	1	1	\$712.00
664X7W20	2" White, 5/Bag	B	1	1	\$1,035.00



664X3R10



664X2W20

## Type B PEX Tube

### Coils

Item Number	Item Description	Pkg Type	Min Qty	Case Qty	Price
<b>100' COILS</b>					
665X8W100	1/8" White	Bl	1	1	\$30.00
665X0W100	1/4" White	Bl	1	1	\$50.00
665X1W100	3/8" White	Bl	1	1	\$51.00
665X2B100	1/2" Blue	Bl	1	1	\$53.00
665X2R100	1/2" Red	Bl	1	1	\$53.00
665X2W100	1/2" White	Bl	1	1	\$53.00
665X3B100	3/4" Blue	Bl	1	1	\$97.00
665X3R100	3/4" Red	Bl	1	1	\$97.00
665X3W100	3/4" White	Bl	1	1	\$97.00
665X4B100	1" Blue	Bl	1	1	\$177.00
665X4R100	1" Red	Bl	1	1	\$177.00
665X4W100	1" White	Bl	1	1	\$177.00
665X5W100	1-1/4" White	Bl	1	1	\$420.00
665X6W100	1-1/2" White	Bl	1	1	\$445.00



665X2R100

Supply

Drainage

Support

Specialties

Appendix



665X2W300



665X2B500



665X2R1000



664X4H20

## Type B PEX Tube (Cont)

### Coils

Item Number	Item Description	Pkg Type	Min Qty	Case Qty	Price
<b>300' COILS</b>					
665X2B300	1/2" Blue	BI	1	1	\$159.00
665X2R300	1/2" Red	BI	1	1	\$159.00
665X2W300	1/2" White	BI	1	1	\$159.00
665X3B300	3/4" Blue	BI	1	1	\$291.00
665X3R300	3/4" Red	BI	1	1	\$291.00
665X3W300	3/4" White	BI	1	1	\$291.00
665X4B300	1" Blue	BI	1	1	\$531.00
665X4R300	1" Red	BI	1	1	\$531.00
665X4W300	1" White	BI	1	1	\$531.00
665X5W300	1-1/4" White	BI	1	1	\$1,260.00
665X6W300	1-1/2" White	BI	1	1	\$1,335.00
<b>500' COILS</b>					
665X2B500	1/2" Blue	BI	1	1	\$265.00
665X2R500	1/2" Red	BI	1	1	\$265.00
665X2W500	1/2" White	BI	1	1	\$265.00
665X3B500	3/4" Blue	BI	1	1	\$485.00
665X3R500	3/4" Red	BI	1	1	\$485.00
665X3W500	3/4" White	BI	1	1	\$485.00
665X4B500	1" Blue	BI	1	1	\$885.00
665X4R500	1" Red	BI	1	1	\$885.00
665X4W500	1" White	BI	1	1	\$885.00
<b>1000' COILS</b>					
665X2B1000	1/2" Blue	BI	1	1	\$530.00
665X2R1000	1/2" Red	BI	1	1	\$530.00
665X2W1000	1/2" White	BI	1	1	\$530.00

## Type B Oxygen Barrier PEX Tube

### Sticks

Item Number	Item Description	Pkg Type	Min Qty	Case Qty	Price
<b>20' STICKS</b>					
664X3H20	3/4" Orange, 25/Bag	B	1	1	\$710.00
664X4H20	1" Orange, 5/Bag	B	1	1	\$222.00

## Type B Oxygen Barrier PEX Tube

### Coils

Item Number	Item Description	Pkg Type	Min Qty	Case Qty	Price
<b>100' COILS</b>					
665X2H100	1/2" Orange	BI	1	1	\$83.00
665X3H100	3/4" Orange	BI	1	1	\$142.00
665X4H100	1" Orange	BI	1	1	\$222.00
665X9H100	5/8" Orange	BI	1	1	\$115.00

## Type B Oxygen Barrier PEX Tube (Cont)

### Coils

Item Number	Item Description	Pkg Type	Min Qty	Case Qty	Price
<b>300' COILS</b>					
665X2H300	1/2" Orange	BI	1	1	\$249.00
665X3H300	3/4" Orange	BI	1	1	\$426.00
665X4H300	1" Orange	BI	1	1	\$666.00
665X9H300	5/8" Orange	BI	1	1	\$345.00
<b>500' COILS</b>					
665X2H500	1/2" Orange	BI	1	1	\$415.00
665X3H500	3/4" Orange	BI	1	1	\$710.00
665X4H500	1" Orange	BI	1	1	\$1,110.00
665X9H500	5/8" Orange	BI	1	1	\$575.00
<b>1000' COILS</b>					
665X2H1000	1/2" Orange	BI	1	1	\$830.00
665X9H1000	5/8" Orange	BI	1	1	\$1,150.00
<b>1200' COILS</b>					
665X2H1200	1/2" Orange	BI	1	1	\$996.00



665X2H300



665X2H500

## Type A PEX Tube

### Sticks

Item Number	Item Description	Pkg Type	Min Qty	Case Qty	Price
<b>20' STICKS</b>					
664XA6W20	1-1/2" White, 5/Bag	B	1	1	\$468.00
664XA7W20	2" White, 5/Bag	B	1	1	\$1,197.00



664XA5W20

## Type A PEX Tube

### Coils

Item Number	Item Description	Pkg Type	Min Qty	Case Qty	Price
<b>100' COILS</b>					
665XA2N100	1/2" Natural	BI	1	1	\$87.00
665XA3N100	3/4" Natural	BI	1	1	\$155.00
665XA4N100	1" Natural	BI	1	1	\$222.00
<b>250' COILS</b>					
665XA2N250	1/2" Natural	BI	1	1	\$217.50
665XA3N250	3/4" Natural	BI	1	1	\$387.50
<b>500' COILS</b>					
665XA2N500	1/2" Natural	BI	1	1	\$435.00



665XA2N100



665XA2N250

Supply

Drainage

Support

Specialties

Appendix



665XA2N300H

## Type A Oxygen Barrier PEX Tube

### Coils

Item Number	Item Description	Pkg Type	Min Qty	Case Qty	Price
<b>300' COILS</b>					
665XA2N300H	1/2" Natural	BI	1	1	\$353.10
<b>1000' COILS</b>					
665XA2N1000H	1/2" Natural	BI	1	1	\$1,180.00



305-X665

## PowerPEX® Tools

### Coil Unwinder

Item Number	Item Description	Pkg Type	Min Qty	Case Qty	Price
305-X665	PEX Tube Coil Unwinder	BI	1	1	\$467.53

# **PowerPEX<sup>®</sup>** **Systems** **for ASTM F1807**

**ASTM F1807 - Fittings, Adapters & Connectors**

**ASTM F1807 - Preformed Copper & Valves**

**ASTM F1807 - PEX Kits**

**ASTM F1807 - Manifolds**

**ASTM F1807 - Tools**



Sioux Chief's PowerPEX<sup>®</sup> ASTM F1807 fitting system utilizes a copper crimp ring or the stainless steel V-Sleeve™, both of which provide 360° of compression around the sealing barbs. Stainless steel cinch clamps can also be used with PowerPex ASTM F1807 fitting system

This time-tested PEX system provides a secure, immediately testable and permanent connection.



649X2  
Page 17



649TX2  
Page 17



649Y2  
Page 17



642X2  
Page 18



642XG4  
Page 18



641XG333  
Page 18



645XG3  
Page 19



645XC3  
Page 19



643X2  
Page 20



646XG3  
Page 21



647XG2E3  
Page 22



637X25  
Page 23



645X2G  
Page 24



630X248E  
Page 25



638X208  
Page 26



631XG02FP  
Page 26



633X18  
Page 27



634XG418FP  
Page 27



648XG3  
Page 28



119X208P  
Page 28



689X3202  
Page 30



672X0399  
Page 32



672X0440  
Page 35



305-7120  
Page 38



304-11  
Page 40

## Male Sweat Fittings

### PRESS-FIT



### COMPATIBLE

All Sioux Chief male sweat, preformed copper fittings are compatible with press-fit systems and all push fit systems. Do not use push fittings with nickel-plated stub outs.

## Lead-Free Compliant



Products made from 'Copper' or 'NL/DZR' material comply with NSF-61 & 372 and with the California No Lead Plumbing Law.



## Crimp Ring

- For use with PEX SDR9 tube only
- Do not use with PB tube

### Related Products

Crimp Tool p 38

Item Number	Item Description	Pkg Type	Min Qty	Case Qty	Price
<b>COPPER</b>					
649X1	3/8" PEX	B	100	1000	\$0.34
649X2	1/2" PEX	B	100	1000	\$0.27
649X3	3/4" PEX	B	100	500	\$0.36
649X4	1" PEX	B	25	250	\$0.90
649X5	1-1/4" PEX	B	25	250	\$3.98
649X6	1-1/2" PEX	B	25	250	\$6.41
649X7	2" PEX	B	10	200	\$7.43



649X2

## V-Sleeve™

### PEX Compression Sleeve

- For use with PEX SDR9 tube only

### Related Products

V-Sleeve™ PEX crimp tools p 40

Item Number	Item Description	Pkg Type	Min Qty	Case Qty	Price
<b>STAINLESS STEEL</b>					
649TX2	1/2" PEX	B	100	1000	\$0.51
649TX3	3/4" PEX	B	100	500	\$0.67
649TX4	1" PEX	B	25	250	\$1.45



649TX2

## Cinch Clamp

- For use with PEX SDR9 piping only
- Do not use with PB tube

Item Number	Item Description	Pkg Type	Min Qty	Case Qty	Price
<b>STAINLESS STEEL</b>					
649Y1PK1	3/8" PEX, 10/Bag	BI	1	200	\$5.37
649Y2	1/2" PEX, 100/Bag	BI	1	20	\$50.20
649Y3	3/4" PEX, 100/Bag	BI	1	10	\$58.94
649Y4PK1	1" PEX, 10/Bag	BI	10	10	\$9.47



649Y2

Supply

Drainage

Support

Specialties

Appendix

Supply

Drainage

Support

Specialties

Appendix



642X2



642XG4



641XG333



641XG323



641XG223

### F1807 Elbow

Item Number	Item Description	Pkg Type	Min Qty	Case Qty	Price
<b>COPPER</b>					
642X2	1/2" × 1/2"	B	25	250	\$1.58
642X3	3/4" × 3/4"	B	25	250	\$2.58
642X43	1" × 3/4"	B	25	25	\$9.36
<b>NL/DZR BRASS</b>					
642XG1	3/8" × 3/8"	B	25	250	\$1.90
642XG2	1/2" × 1/2"	B	25	250	\$1.87
642XG23	1/2" × 3/4"	B	25	250	\$2.26
642XG3	3/4" × 3/4"	B	25	250	\$2.85
642XG4	1" × 1"	B	25	25	\$5.35
642XG43	1" × 3/4"	B	25	25	\$16.62

### F1807 Tee

Item Number	Item Description	Pkg Type	Min Qty	Case Qty	Price
<b>STANDARD TEE - NL/DZR BRASS</b>					
641XG111	3/8" × 3/8" × 3/8"	B	50	500	\$2.34
641XG222	1/2" × 1/2" × 1/2"	B	50	50	\$2.38
641XG333	3/4" × 3/4" × 3/4"	B	20	200	\$3.94
641XG444	1" × 1" × 1"	B	20	200	\$7.93
<b>REDUCING TEE - NL/DZR BRASS</b>					
641XG322	3/4" × 1/2" × 1/2"	B	20	200	\$3.27
641XG323	3/4" × 1/2" × 3/4"	B	20	200	\$3.72
641XG332	3/4" × 3/4" × 1/2"	B	20	200	\$3.27
641XG442	1" × 1" × 1/2"	B	20	200	\$6.18
641XG443	1" × 1" × 3/4"	B	20	200	\$6.49
<b>BULLHEAD TEE- NL/DZR BRASS</b>					
641XG223	1/2" × 1/2" × 3/4"	B	20	200	\$3.04

**F1807 Coupling**

Item Number	Item Description	Pkg Type	Min Qty	Case Qty	Price
<b>COPPER</b>					
645X2	1/2" × 1/2"	B	100	1000	\$0.84
645X3	3/4" × 3/4"	B	50	500	\$1.14
645X32	3/4" × 1/2"	B	50	500	\$3.10
645X4	1" × 1"	B	25	250	\$2.89
645X43	1" × 3/4"	B	25	250	\$3.00
645X5	1-1/4" × 1-1/4"	B	10	10	\$7.57
645X54	1-1/4" × 1"	B	10	10	\$8.12
<b>NL/DZR BRASS</b>					
645XG1	3/8" × 3/8"	B	100	1000	\$1.04
645XG12	1/2" × 3/8"	B	50	500	\$2.83
645XG2	1/2" × 1/2"	B	100	1000	\$1.27
645XG3	3/4" × 3/4"	B	50	500	\$2.13
645XG32	3/4" × 1/2"	B	50	500	\$1.95
645XG4	1" × 1"	B	25	250	\$3.34
645XG43	1" × 3/4"	B	25	250	\$3.34



645X2



645XG2

**F1807 Plug**

Item Number	Item Description	Pkg Type	Min Qty	Case Qty	Price
<b>NL/DZR BRASS</b>					
640XG01	3/8" F1807	B	100	1000	\$0.91
640XG02	1/2" F1807	B	100	1000	\$0.91
640XG03	3/4" F1807	B	100	1000	\$1.77
640XG04	1" F1807	B	25	250	\$2.70



640XG02

**F1807 Straight Adapter**

**CPVC, CTS**

Item Number	Item Description	Pkg Type	Min Qty	Case Qty	Price
<b>CPVC CUP - COPPER</b>					
645XC2	1/2" F1807 × 1/2" CPVC	B	50	50	\$5.84
645XC23	1/2" F1807 × 3/4" CPVC	B	50	50	\$10.06
645XC2PK2	1/2" F1807 × 1/2" CPVC, 1/Bag	Cl	10	10	\$5.99
645XC3	3/4" F1807 × 3/4" CPVC	B	50	50	\$6.47
645XC34	3/4" F1807 × 1" CPVC	B	20	20	\$17.82
645XC3PK2	3/4" F1807 × 3/4" CPVC, 1/Bag	Cl	10	10	\$6.62
645XC4	1" F1807 × 1" CPVC	B	20	20	\$17.52
645XC43	1" F1807 × 3/4" CPVC	B	20	20	\$17.82
<b>CPVC CUP - NL/DZR BRASS</b>					
645XGC2	1/2" F1807 × 1/2" CPVC	B	50	50	\$17.36
645XGC3	3/4" F1807 × 3/4" CPVC	B	50	50	\$13.74
645XGC4	1" F1807 × 1" CPVC	X	20	20	\$25.39
<b>CPVC MALE - COPPER</b>					
645XCM2	1/2" F1807 × 1/2" Male CPVC	B	50	50	\$8.62



645XGC3



645XCM2

Supply

Drainage

Support

Specialties

Appendix



645XC93

### F1807 Straight Adapter

#### CPVC - IPS Gray

Item Number	Item Description	Pkg Type	Min Qty	Case Qty	Price
<b>COPPER</b>					
645XC923	1/2" F1807 × 3/4" Sch 40 CPVC	B	25	25	\$12.47
645XC93	3/4" F1807 × 3/4" Sch 40 CPVC	B	50	50	\$12.15
645XC94	1" F1807 × 1" Sch 40 CPVC	B	20	20	\$24.41



645X3P

### F1807 Straight Adapter

#### PVC

· For cold water applications. Do not exceed 140° F.

Item Number	Item Description	Pkg Type	Min Qty	Case Qty	Price
<b>COPPER</b>					
645X23P	1/2" F1807 × 3/4" PVC	B	50	50	\$12.53
645X34P	3/4" F1807 × 1" PVC	B	20	20	\$18.73
645X3P	3/4" F1807 × 3/4" PVC	B	50	50	\$11.89
645X43P	1" F1807 × 3/4" PVC	B	20	20	\$18.86
645X4P	1" F1807 × 1" PVC	B	20	20	\$19.64



643X2

### F1807 Straight Adapter

#### Male Sweat

Item Number	Item Description	Pkg Type	Min Qty	Case Qty	Price
<b>COPPER</b>					
643X2	1/2" F1807 × 1/2" MSWT	B	100	1000	\$0.97
643X202	1/2" F1807 × 1/2" MSWT, 2" Long	B	50	500	\$2.91
643X23	3/4" F1807 × 1/2" MSWT	B	50	100	\$1.81
643X3	3/4" F1807 × 3/4" MSWT	B	50	500	\$1.77
643X32	1/2" F1807 × 3/4" MSWT	B	50	500	\$3.96
643X34	1" F1807 × 3/4" MSWT	B	25	250	\$3.96
643X4	1" F1807 × 1" MSWT	B	25	250	\$4.01
643X43	3/4" F1807 × 1" MSWT	B	25	250	\$4.88
643X5	1-1/4" F1807 × 1-1/4" MSWT	B	10	10	\$10.82
<b>NL/DZR BRASS</b>					
643XG1	3/8" F1807 × 1/2" MSWT	B	100	1000	\$7.37
643XG2	1/2" F1807 × 1/2" MSWT	B	100	1000	\$1.52
643XG23	3/4" F1807 × 1/2" MSWT	B	50	500	\$4.23
643XG3	3/4" F1807 × 3/4" MSWT	B	50	500	\$2.61
643XG32	1/2" F1807 × 3/4" MSWT	B	50	500	\$5.39
643XG34	1" F1807 × 3/4" MSWT	B	25	250	\$5.85
643XG4	1" F1807 × 1" MSWT	B	25	250	\$4.13
643XG43	3/4" F1807 × 1" MSWT	B	25	250	\$7.09

## F1807 Straight Adapter

### Female Sweat

Item Number	Item Description	Pkg Type	Min Qty	Case Qty	Price
<b>COPPER</b>					
644X2	1/2" F1807 × 1/2" FSWT	B	100	1000	\$1.07
644X23	3/4" F1807 × 1/2" FSWT	B	25	100	\$2.24
644X3	3/4" F1807 × 3/4" FSWT	B	50	500	\$1.81
644X32	1/2" F1807 × 3/4" FSWT	B	50	500	\$4.02
644X34	1" F1807 × 3/4" FSWT	B	25	250	\$4.57
644X4	1" F1807 × 1" FSWT	B	25	250	\$4.58
644X43	3/4" F1807 × 1" FSWT	B	25	250	\$4.49
644X5	1-1/4" F1807 × 1-1/4" FSWT	B	10	10	\$11.90
<b>NL/DZR BRASS</b>					
644XG1	3/8" F1807 × 1/2" FSWT	B	100	500	\$4.04
644XG2	1/2" F1807 × 1/2" FSWT	B	100	1000	\$1.56
644XG3	3/4" F1807 × 3/4" FSWT	B	50	500	\$2.69
644XG32	1/2" F1807 × 3/4" FSWT	B	50	500	\$7.10
644XG4	1" F1807 × 1" FSWT	B	25	250	\$4.55
644XG43	3/4" F1807 × 1" FSWT	B	25	250	\$9.48



644X2



644XG2

## F1807 Straight Adapter

### MIP

Item Number	Item Description	Pkg Type	Min Qty	Case Qty	Price
<b>NL/DZR BRASS</b>					
646XG2	1/2" F1807 × 1/2" MIP	B	100	100	\$2.61
646XG23	3/4" F1807 × 1/2" MIP	B	50	50	\$2.78
646XG3	3/4" F1807 × 3/4" MIP	B	25	250	\$3.85
646XG32	1/2" F1807 × 3/4" MIP	B	50	50	\$3.72
646XG34	1" F1807 × 3/4" MIP	B	25	25	\$4.55
646XG4	1" F1807 × 1" MIP	B	50	50	\$6.56
646XG43	3/4" F1807 × 1" MIP	B	50	50	\$6.42



646XG2

## F1807 Straight Adapter

### FIP

Item Number	Item Description	Pkg Type	Min Qty	Case Qty	Price
<b>NL/DZR BRASS</b>					
647XG2	1/2" F1807 × 1/2" FIP	B	50	250	\$2.91
647XG23PK2	1/2" F1807 × 3/4" FIP, 1/Bag	Cl	10	10	\$8.03
647XG3	3/4" F1807 × 3/4" FIP	B	50	50	\$4.35
647XG4	1" F1807 × 1" FIP	B	50	50	\$8.61



647XG2

Supply

Drainage

Support

Specialties

Appendix

Supply

Drainage

Support

Specialties

Appendix



632XG332M

### F1807 Elbow Adapter

#### MIP

Item Number	Item Description	Pkg Type	Min Qty	Case Qty	Price
<b>NL/DZR BRASS</b>					
632XG222M	1/2" F1807 × 1/2" MIP	B	50	50	\$7.77
632XG332M	3/4" F1807 × 3/4" MIP	B	50	50	\$18.32



647XG2E3

### F1807 Elbow Adapter

#### Tub/Shower Elbow

##### Related Products

Shower Arm Test Plug p 473  
WiderSlider™ Adjustable Bracket p 533

Item Number	Item Description	Pkg Type	Min Qty	Case Qty	Price
<b>DROP-EAR - NL/DZR BRASS</b>					
647XG21E3	1/2" F1807 × 3/8" FIP	B	25	25	\$8.31
647XG2E3	1/2" F1807 × 1/2" FIP	B	50	50	\$10.38
647XG2EPK1	1/2" F1807 × 1/2" FIP, 1/Bag	B	20	20	\$10.19
<b>DROP-EAR - LEADED</b>					
647X23E	3/4" F1807 × 1/2" FIP	B	50	50	\$9.94
<b>SHOWER-LOCK - LEADED</b>					
616X2PX	1/2" F1807 × 1/2" FIP	B	50	50	\$17.15



616X2PX



637X235

### F1807 Elbow Adapter

#### 3/4" FIP Swivel

· DO NOT use pipe dope on FIP swivel threads

Item Number	Item Description	Pkg Type	Min Qty	Case Qty	Price
<b>NL/DZR</b>					
637X235	1/2" F1807	B	50	50	\$10.38
637X335	3/4" F1807	B	25	25	\$9.69

## F1807 Elbow Adapter

### Male Sweat

**Related Products**

Tub/Shower Connector p 26

Item Number	Item Description	Pkg Type	Min Qty	Case Qty	Price
<b>COPPER</b>					
632X222	1/2" F1807 × 1/2" MSWT	B	100	1000	\$2.59
632X332	3/4" F1807 × 3/4" MSWT	B	25	250	\$3.88



632X222

## F1807 Elbow Adapter

### Female Sweat

Item Number	Item Description	Pkg Type	Min Qty	Case Qty	Price
<b>COPPER</b>					
632X225	1/2" F1807 × 1/2" FSWT	B	100	1000	\$2.59
632X335	3/4" F1807 × 3/4" FSWT	B	25	250	\$3.88



632X225

## F1807 Ballcock Adapter

### Toilet Swivel

· Nose cone seal. Do not use thread sealant

Item Number	Item Description	Pkg Type	Min Qty	Case Qty	Price
<b>ELBOW - COPPER</b>					
637X423PK	1/2" F1807 × Ballcock Swivel	Cl	10	10	\$7.96

## F1807 Faucet Adapter

### 1/2" FIP Swivel

· Nose cone seal. Do not use thread sealant

Item Number	Item Description	Pkg Type	Min Qty	Case Qty	Price
<b>STRAIGHT - COPPER</b>					
637X20	1/2" F1807	B	50	500	\$1.91
637X20PK2	1/2" F1807, 2/Bag	Cl	10	10	\$4.12
<b>ELBOW - COPPER</b>					
637X25	1/2" F1807	B	50	50	\$3.40



637X10



637X25

Supply

Drainage

Support

Specialties

Appendix



637XG721

### Straight Adapter Compression

· DO NOT use pipe dope on comp. threads

Item Number	Item Description	Pkg Type	Min Qty	Case Qty	Price
<b>NL/DZR</b>					
637XG711	3/8" F1807 × 3/8" O.D. Comp.	B	20	20	\$11.30
637XG721	1/2" F1807 × 3/8" O.D. Comp.	B	20	20	\$9.99



645X2GPK2

### Straight Adapter Polybutylene (PB) (ASTM F1380) × PEX

· For use with PEX SDR9 tube only

Item Number	Item Description	Pkg Type	Min Qty	Case Qty	Price
<b>COPPER</b>					
645X2G	1/2" F1807 × 1/2" PB w/Rings	B	50	50	\$2.71
645X2GPK2	1/2" F1807 × 1/2" PB w/Rings, 1/Bag	CI	10	10	\$2.86
645X3G	3/4" F1807 × 3/4" PB w/Rings	B	50	50	\$3.22
645X3GPK2	3/4" F1807 × 3/4" PB w/Rings, 1/Bag	CI	10	10	\$3.52



**F1807 Stub Out Elbow**

**Related Products**

F1807 Stub Out Kit p 30

Item Number	Item Description	Pkg Type	Min Qty	Case Qty	Price
630X146	3/8" F1807, 3-1/2" x 6"	B	50	50	\$6.20
630X148	3/8" F1807, 3-1/2" x 8"	B	50	50	\$6.95
630X2138	1/2" F1807, 13" x 8"	B	50	50	\$15.12
630X2412	1/2" F1807, 3-1/2" x 12"	B	50	50	\$10.41
630X246	1/2" F1807, 3-1/2" x 6"	B	50	50	\$5.58
630X248	1/2" F1807, 3-1/2" x 8"	B	50	50	\$6.42
630X248PK	1/2" F1807, 3-1/2" x 8"	Cl	6	6	\$6.92
630X3136	3/4" F1807, 13" x 6"	B	50	50	\$20.85
630X3412	3/4" F1807, 4-1/2" x 12"	B	50	50	\$20.84
630X348	3/4" F1807, 4-1/2" x 8"	B	50	50	\$19.15
630X4612	1" F1807, 6" x 12"	B	25	25	\$34.75
630X468	1" F1807, 6" x 8"	B	25	25	\$26.38



630X248

**F1807 Stub Out Elbow**

**Square O Strap**

Item Number	Item Description	Pkg Type	Min Qty	Case Qty	Price
630X148E	3/8" F1807, 3-1/2" x 8" w/Strap	B	25	25	\$7.93
630X2412E	1/2" F1807, 3-1/2" x 12" w/Strap	B	25	25	\$11.41
630X246E	1/2" F1807, 3-1/2" x 6" w/Strap	B	25	25	\$6.58
630X248E	1/2" F1807, 3-1/2" x 8" w/Strap	B	25	25	\$7.40
630X248EPK	1/2" F1807, 3-1/2" x 8" w/Strap	Cl	20	20	\$7.90
630X348E	3/4" F1807, 4-1/2" x 8" w/Strap	B	25	25	\$20.15
630X468E	1" F1807, 6" x 8" w/Strap	B	10	10	\$27.38



630X248E

**F1807 Stub Out Elbow**

**Double Stub Out**

**Related Products**

3-Valve Kitchen Supply Box p 179

Item Number	Item Description	Pkg Type	Min Qty	Case Qty	Price
630XD288	1/2" F1807, 7" x 8" x 8"	B	25	25	\$25.63



630XD288

Supply

Drainage

Support

Specialties

Appendix

Supply

Drainage

Support

Specialties

Appendix



643X208

### F1807 Bullet™

· Not to be used as permanent air chambers

Item Number	Item Description	Pkg Type	Min Qty	Case Qty	Price
<b>SPUN CLOSED</b>					
638X208	1/2" F1807, 8"	B	100	100	\$5.16
638X208PK	1/2" F1807, 8"	CI	20	20	\$5.66
638X212	1/2" F1807, 12"	B	100	100	\$7.18
638X312	3/4" F1807, 12"	B	50	50	\$14.28
<b>SPUN CLOSED WITH STRAP</b>					
638X212E	1/2" F1807, 12" Long, 8" Stub Out	B	50	50	\$8.82
638X218E	1/2" F1807, 18" Long, 10" Stub Out	B	25	25	\$12.36
<b>OPEN ENDED STUB OUT</b>					
643X208	1/2" F1807, 8"	B	100	100	\$5.31
643X212	1/2" F1807, 12"	B	100	100	\$7.15

### F1807 Tub/Shower Pressure Connector

· DO NOT use pipe dope on FIP swivel threads



632X283



632X263Y

Item Number	Item Description	Pkg Type	Min Qty	Case Qty	Price
632X243	1/2" F1807 × 1/2" MSWT, 4" × 2-1/4"	B	50	50	\$4.01
632X243PK	1/2" F1807 × 1/2" MSWT, 4" × 2-1/4"	CI	20	20	\$4.51
632X263	1/2" F1807 × 1/2" MSWT, 6" × 2-1/4"	B	50	50	\$4.82
632X263X	1/2" F1807 × 1/2" MIP Swivel, 6" × 3"	B	50	50	\$11.72
632X263Y	1/2" F1807 × 1/2" FIP Swivel, 6" × 3"	B	50	50	\$11.02
632X283	1/2" F1807 × 1/2" MSWT, 8" × 2-1/4"	B	50	50	\$6.17
632X458	1" F1807 × 1" MSWT, 5" × 8"	B	25	25	\$25.41

### F1807 Water Heater Connector

#### FIP Swivel Elbow

· DO NOT use pipe dope on FIP swivel threads



631X02



631XG02FP

Item Number	Item Description	Pkg Type	Min Qty	Case Qty	Price
<b>STANDARD</b>					
631X02	3/4" F1807 × 3/4" FIP Swivel, 4-1/2" × 2"	B	25	25	\$16.72
<b>631XG3TM9</b>	3/4" F1807 × 3/4" FIP Swivel, w/ 3/4" MIP Branch, 6" × 9"	B	25	25	\$36.14
<b>VALVED, FULL PORT</b>					
631XG02FP	3/4" F1807 × 3/4" FIP Swivel, 6" × 3"	B	12	12	\$51.72

## F1807 Water Heater Connector

### FIP Swivel Straight

· DO NOT use pipe dope on FIP swivel threads

Item Number	Item Description	Pkg Type	Min Qty	Case Qty	Price
<b>STANDARD</b>					
633X02	3/4" F1807 × 3/4" FIP Swivel, 2"	B	25	25	\$8.92
633X18	3/4" F1807 × 3/4" FIP Swivel, 18"	B	25	25	\$24.28
633X18PK	3/4" F1807 × 3/4" FIP Swivel, 18", 1/Bag	Cl	25	25	\$24.78
<b>VALVED, FULL PORT</b>					
633XG18FP	3/4" F1807 × 3/4" FIP Swivel, 18"	Bl	10	10	\$59.28
633XG18FPT	3/4" F1807 × 3/4" FIP Swivel, w/ 3/4" FIP Branch, 18"	B	10	10	\$73.28
<b>THERMAL EXPANSION VALVE, FULL PORT</b>					
633XG18FRV	3/4" F1807 × 3/4" FIP Swivel, w/ Pressure Relief 3/8" Comp., 18"	B	10	10	\$69.28
633XG18HRV	3/4" F1807 × 3/4" FIP Swivel, w/ Pressure Relief 3/8" Hose Barb, 18"	B	10	10	\$69.28
633XG18XRV	3/4" F1807 × 3/4" FIP Swivel, w/ Pressure Relief 1/2" F1807, 18"	B	10	10	\$69.28
<b>ADJUSTABLE REPLACEMENT RELIEF PORT</b>					
648-ARX	1/8" MIP × 1/2" F1807 (80-125 PSI)	Bl	6	6	\$9.80



## F1807 Water Heater Connector

### Flexible Copper, FIP Swivel

· DO NOT use pipe dope on FIP swivel threads  
· Do not twist or kink flexible connector

Item Number	Item Description	Pkg Type	Min Qty	Case Qty	Price
<b>STANDARD</b>					
634X418	3/4" F1807 × 3/4" FIP Swivel, 18"	Bl	10	10	\$20.69
<b>VALVED, FULL PORT</b>					
634XG418FP	3/4" F1807 × 3/4" FIP Swivel, 18"	Bl	25	25	\$55.69



## F1807 Water Loop

### Water Heater Stub Out Loop

Item Number	Item Description	Pkg Type	Min Qty	Case Qty	Price
636X38883	3/4" F1807	B	12	12	\$56.03
636X48884	1" F1807	B	12	12	\$76.35



Supply

Drainage

Support

Specialties

Appendix

Supply



648XG3

Drainage



648-3SX

Support



648XG3XRV

Specialties

Appendix



117X2



118X208



119X208P

### F1807 Brass Ball Valve

Item Number	Item Description	Pkg Type	Min Qty	Case Qty	Price
<b>FULL PORT</b>					
648XG2	1/2" F1807	B	10	120	\$12.93
648XG2PK	1/2" F1807	CI	10	10	\$13.43
648XG3	3/4" F1807	B	8	96	\$19.53
648XG3PK	3/4" F1807	CI	10	10	\$20.03
648XG4	1" F1807	B	4	40	\$34.48
648XG4PK	1" F1807	CI	6	6	\$34.98
<b>FULL PORT WITH DRAIN</b>					
648XG3FPD	3/4" F1807	B	5	30	\$30.05
<b>FULL PORT FIPS X F1807</b>					
648-3SX	3/4" FIPS x 3/4" F1807	X	5	5	\$33.66
<b>THERMAL EXPANSION VALVE - 125 PSI</b>					
648XG3XRV	3/4" F1807 x 3/4" F1807, 1/2" F1807 Port	BI	6	6	\$45.00

### F1807 Sillcock

Item Number	Item Description	Pkg Type	Min Qty	Case Qty	Price
<b>LEADED BRASS</b>					
117X2	1/2" F1807	BI	10	100	\$21.36

### F1807 Frost-Proof Anti-Siphon Sillcock

#### Related Products

Frost-Proof Sillcock Replacement Parts p 114

Item Number	Item Description	Pkg Type	Min Qty	Case Qty	Price
<b>MULTI-TURN - LEADED</b>					
118X204	1/2" F1807 x 3/4" MHT, 4"	BI	1	40	\$32.18
118X206	1/2" F1807 x 3/4" MHT, 6"	BI	1	40	\$33.44
118X208	1/2" F1807 x 3/4" MHT, 8"	BI	1	40	\$34.07
118X210	1/2" F1807 x 3/4" MHT, 10"	BI	1	40	\$36.14
118X212	1/2" F1807 x 3/4" MHT, 12"	BI	2	40	\$37.41
<b>1/4 TURN - LEADED</b>					
119X204P	1/2" F1807 x 3/4" MHT, 4"	B	2	2	\$59.19
119X206P	1/2" F1807 x 3/4" MHT, 6"	B	5	5	\$64.18
119X208P	1/2" F1807 x 3/4" MHT, 8"	B	5	5	\$66.09
119X210P	1/2" F1807 x 3/4" MHT, 10"	B	5	5	\$69.92
119X212P	1/2" F1807 x 3/4" MHT, 12"	B	5	5	\$77.58

## F1807 Ice Maker Valve

### Straight & Tee

· DO NOT use pipe dope on comp. threads

#### Related Products

Add-A-Line™ Push Valve p 129

Item Number	Item Description	Pkg Type	Min Qty	Case Qty	Price
<b>STRAIGHT - NL/DZR BRASS</b>					
637XG920	1/2" F1807 × 1/4" O.D. Comp.	B	25	250	\$20.67
637XG920PK1	1/2" F1807 × 1/4" O.D. Comp., 1/Bag	Bl	10	10	\$20.92
<b>TEE - NL/DZR BRASS</b>					
637XG9220	1/2" F1807 × 1/4" O.D. Comp.	B	25	250	\$28.91
637XG9220PK1	1/2" F1807 × 1/4" O.D. Comp., 1/Bag	Bl	10	10	\$29.16



637XG920



637XG9220

Supply

Drainage

Support

Specialties

Appendix



689X2101

### F1807 Stub Out Kit

#### 1/2" Water Closet Stub Out With Bracket

· For individual product details, see product pages

Item Number	Item Description	Pkg Type	Min Qty	Case Qty	Price
<b>16" STUD BAY</b>					
689X2101	(1) 525-1612, (1) 630X246	BI	12	12	\$11.04
689X2201	(1) 525-1612, (1) 630X248	BI	12	12	\$11.88



689X3102

### F1807 Stub Out Kit

#### 1/2" Lav/Sink Stub Outs With Bracket

· For individual product details, see product pages

Item Number	Item Description	Pkg Type	Min Qty	Case Qty	Price
<b>16" STUD BAY</b>					
689X3102	(1) 525-1622, (2) 630X246	BI	12	12	\$17.96
689X3202	(1) 525-1622, (2) 630X248	BI	12	12	\$19.64
<b>24" STUD BAY</b>					
689X3112	(1) 525-2422, (2) 630X246	BI	12	12	\$18.70
689X3212	(1) 525-2422, (2) 630X248	BI	12	12	\$20.38



689XG211

### F1807 Stub Out Kit

#### StopOut™

Item Number	Item Description	Pkg Type	Min Qty	Case Qty	Price
689XG11	1/2" F1807 x (1) 3/8" Comp.	B	10	10	\$19.79
689XG201	1/2" F1807 x (1) 1/4" Comp. (1) 3/8" Comp.	B	10	10	\$38.08
689XG211	1/2" F1807 x (2) 3/8" Comp.	B	10	10	\$36.77



689X5103

### F1807 Stub Out Kit

#### 3/4" Water Heater Stub Outs With Bracket

· For individual product details, see product pages

Item Number	Item Description	Pkg Type	Min Qty	Case Qty	Price
689X5103	(1) 525-1623, (2) 630X348	BI	12	12	\$46.47

## F1807 Stub Out Kit

### 1/2" Shower Riser Elbow With Bracket

· For individual product details, see product pages

#### Related Products

Shower WallNut™ p 640

Item Number	Item Description	Pkg Type	Min Qty	Case Qty	Price
689X2291	(1) 525-16WLB, (1) 630X248	BI	12	12	\$13.34



689X2291

## F1807 Water Heater Connector Kit

· DO NOT use pipe dope on FIP swivel threads  
 · For individual product details, see product pages

Item Number	Item Description	Pkg Type	Min Qty	Case Qty	Price
694XG32012091	(1) 631XG02FP, (1) 633-G3TM15, (1) 633X18	BI	10	10	\$117.40
694XG32012093	(1) 631XG02FP, (1) 633-G3TM11, (1) 633X18	BI	10	10	\$113.56
694XG322120	(1) 633X18, (1) 633XG18FP	BI	10	10	\$85.56



694XG32012091

Supply

Drainage

Support

Specialties

Appendix

Supply



### 1/2" F1807 Branch, Manifold 3/4" F1807 × Spun Closed Trunk

· Do not recirculate back through any manifold branch. Do not modify manifold. Doing so will void warranty

Drainage



Item Number	Item Description	Pkg Type	Min Qty	Case Qty	Price
<b>COPPER BRANCHES</b>					
672X0390	1/2" F1807, 3 Port	B	25	25	\$23.67
672X0390PK	1/2" F1807, 3 Port	BI	5	5	\$24.17
672X0490	1/2" F1807, 4 Port	B	25	25	\$28.83
672X0490PK	1/2" F1807, 4 Port	BI	5	5	\$29.33
672X0590	1/2" F1807, 5 Port	B	25	25	\$33.99
672X0690	1/2" F1807, 6 Port	B	25	25	\$39.15
672X0690PK	1/2" F1807, 6 Port	BI	5	5	\$39.65
672X0790	1/2" F1807, 7 Port	B	25	25	\$44.31
672X0890	1/2" F1807, 8 Port	B	25	25	\$49.47
672X0990	1/2" F1807, 9 Port	B	25	25	\$54.63
672X1090	1/2" F1807, 10 Port	B	25	25	\$59.79
672X1290	1/2" F1807, 12 Port	B	25	25	\$70.11
<b>BALL VALVE BRANCHES</b>					
672XV0490	1/2" F1807 Ball Valve, 4 Port	BI	1	10	\$116.64
672XV0490PK	1/2" F1807 Ball Valve, 4 Port	BI	5	5	\$117.14
672XV0590	1/2" F1807 Ball Valve, 5 Port	BI	1	10	\$144.69
672XV0690	1/2" F1807 Ball Valve, 6 Port	BI	1	10	\$170.54

Support

Specialties

Appendix



### 1/2" F1807 Branch, Manifold 3/4" F1807 × 3/4" F1807 Trunk

· Do not recirculate back through any manifold branch. Do not modify manifold. Doing so will void warranty



Item Number	Item Description	Pkg Type	Min Qty	Case Qty	Price
<b>STANDARD</b>					
672X0399	1/2" F1807, 3 Port	B	25	25	\$23.15
672X0499	1/2" F1807, 4 Port	B	25	25	\$28.31
<b>672X0499PK</b>	1/2" F1807, 4 Port	BI	6	6	\$28.81
672X0599	1/2" F1807, 5 Port	B	25	25	\$33.47
672X0699	1/2" F1807, 6 Port	B	25	25	\$38.63
672X0699PK	1/2" F1807, 6 Port	BI	6	6	\$39.13
672X0899	1/2" F1807, 8 Port	B	25	25	\$48.95
672X0999	1/2" F1807, 9 Port	B	25	25	\$54.11
672X1299	1/2" F1807, 12 Port	B	25	25	\$69.59
<b>BALL VALVE BRANCHES</b>					
672XV0499	1/2" F1807 Ball Valve, 4 Port	BI	1	10	\$117.22
672XV0599	1/2" F1807 Ball Valve, 5 Port	BI	1	10	\$144.17
672XV0699	1/2" F1807 Ball Valve, 6 Port	BI	1	10	\$170.68
672XV0699-2PK	1/2" F1807 Ball Valve, 6 Port	BI	5	5	\$171.18



**1/2" F1807 Branch, Manifold**

**1/2" F1807 × Closed Trunk**

· Do not recirculate back through any manifold branch. Do not modify manifold. Doing so will void warranty



Item Number	Item Description	Pkg Type	Min Qty	Case Qty	Price
672X0380	1/2" F1807, 3 Port	B	25	25	\$23.40
672X0480	1/2" F1807, 4 Port	B	25	25	\$28.56

**1/2" F1807 Branch, Manifold**

**1/2" F1807 × 3/4" F1807 Trunk**

· Do not recirculate back through any manifold branch. Do not modify manifold. Doing so will void warranty



Item Number	Item Description	Pkg Type	Min Qty	Case Qty	Price
672X0698	1/2" F1807, 6 Port	B	25	25	\$38.36

**1/2" F1807 Branch, Manifold**

**1" F1807 × Spun Closed Trunk**

· Do not recirculate back through any manifold branch. Do not modify manifold. Doing so will void warranty



Item Number	Item Description	Pkg Type	Min Qty	Case Qty	Price
672X0470	1/2" F1807, 4 Port	B	10	10	\$29.35
672X0670	1/2" F1807, 6 Port	B	10	10	\$39.67
672X0870	1/2" F1807, 8 Port	B	10	10	\$43.17
672X1270	1/2" F1807, 12 Port	B	10	10	\$70.63

**1/2" F1807 Branch, Manifold**

**3/4" F1807 × 1" F1807 Trunk**

· Do not recirculate back through any manifold branch. Do not modify manifold. Doing so will void warranty



Item Number	Item Description	Pkg Type	Min Qty	Case Qty	Price
672X0497	1/2" F1807, 4 Port	B	10	10	\$28.83
672X0697	1/2" F1807, 6 Port	B	10	10	\$39.15
672X0897	1/2" F1807, 8 Port	B	10	10	\$49.47
672X1297	1/2" F1807, 12 Port	B	10	10	\$70.11

Supply

Drainage

Support

Specialties

Appendix



### 1/2" F1807 Branch, Manifold

#### 1" F1807 × 1" F1807 Trunk

· Do not recirculate back through any manifold branch. Do not modify manifold. Doing so will void warranty

Item Number	Item Description	Pkg Type	Min Qty	Case Qty	Price
672X0477	1/2" F1807, 4 Port	B	10	10	\$29.35
672X0677	1/2" F1807, 6 Port	B	10	10	\$39.67
672X0877	1/2" F1807, 8 Port	B	10	10	\$49.99
672X1277	1/2" F1807, 12 Port	B	10	10	\$70.63



### 1/2" F1807 Branch, Manifold

#### 3/4" MSWT× Spun Closed Trunk

· Do not recirculate back through any manifold branch. Do not modify manifold. Doing so will void warranty

Item Number	Item Description	Pkg Type	Min Qty	Case Qty	Price
672X0330	1/2" F1807, 3 Port	B	25	25	\$24.89
672X0430	1/2" F1807, 4 Port	B	25	25	\$30.05
672X0630	1/2" F1807, 6 Port	B	25	25	\$40.04
672X0830	1/2" F1807, 8 Port	B	25	25	\$50.36
672X0930	1/2" F1807, 9 Port	B	25	25	\$55.85
672X1230	1/2" F1807, 12 Port	B	25	25	\$71.00



672X0431PK

### 1/2" F1807 Branch, Manifold

#### 3/4" MSWT × 3/4" FS WT Trunk

· Do not recirculate back through any manifold branch. Do not modify manifold. Doing so will void warranty

Item Number	Item Description	Pkg Type	Min Qty	Case Qty	Price
<b>COPPER BRANCHES</b>					
672X0431PK	1/2" F1807, 4 Port	BI	5	5	\$33.49
<b>BALL VALVE BRANCHES</b>					
672XV0486PK	1/2" F1807 Ball Valve, 4 Port	BI	5	5	\$115.99

**1/2" F1807 Branch, Manifold**

**3/4" MSWT × 3/4" MSWT, Extended Trunk**



· Do not recirculate back through any manifold branch. Do not modify manifold. Doing so will void warranty

Item Number	Item Description	Pkg Type	Min Qty	Case Qty	Price
672X0433EE	1/2" F1807, 4 Port	B	10	10	\$45.62
672X0633EE	1/2" F1807, 6 Port	B	10	10	\$55.94
672X0833EE	1/2" F1807, 8 Port	B	10	10	\$66.26
672X1033EE	1/2" F1807, 10 Port	B	10	10	\$76.58
672X1233EE	1/2" F1807, 12 Port	B	10	10	\$86.90

**1/2" F1807 Branch, Manifold**

**1" MSWT × Spun Closed Trunk**



· Do not recirculate back through any manifold branch. Do not modify manifold. Doing so will void warranty

Item Number	Item Description	Pkg Type	Min Qty	Case Qty	Price
672X0440	1/2" F1807, 4 Port	B	25	25	\$32.06
672X0640	1/2" F1807, 6 Port	B	25	25	\$40.84
672X0840	1/2" F1807, 8 Port	B	25	25	\$50.95
672X1240	1/2" F1807, 12 Port	B	25	25	\$72.13

**1/2" F1807 Branch, Manifold**

**1" MSWT × 1" MSWT Trunk**



· Do not recirculate back through any manifold branch. Do not modify manifold. Doing so will void warranty

Item Number	Item Description	Pkg Type	Min Qty	Case Qty	Price
672X0644	1/2" F1807, 6 Port	B	25	25	\$42.63
672X0844	1/2" F1807, 8 Port	B	25	25	\$53.00
672X1244	1/2" F1807, 12 Port	B	25	25	\$73.64

Supply

Drainage

Support

Specialties

Appendix

Supply

Drainage

Support

Specialties

Appendix



## 1/2" F1807 Branch, Manifold

### 1" FSWT × Spun Closed Trunk

· Do not recirculate back through any manifold branch. Do not modify manifold. Doing so will void warranty

Item Number	Item Description	Pkg Type	Min Qty	Case Qty	Price
<b>RIGHT-SIDE BALL VALVE BRANCHES</b>					
672XV0810	1/2" F1807 Ball Valve, 8 Port	BI	1	10	\$224.84
672XV1010	1/2" F1807 Ball Valve, 10 Port	BI	1	10	\$278.74
672XV1210	1/2" F1807 Ball Valve, 12 Port	BI	1	4	\$332.64
672XV1510	1/2" F1807 Ball Valve, 15 Port	BI	1	5	\$413.49
672XV1810	1/2" F1807 Ball Valve, 18 Port	BI	1	5	\$494.34
<b>LEFT-SIDE BALL VALVE BRANCHES</b>					
672XV0810L	1/2" F1807 Ball Valve, 8 Port	BI	1	10	\$224.84
672XV1010L	1/2" F1807 Ball Valve, 10 Port	BI	1	10	\$278.74
672XV1210L	1/2" F1807 Ball Valve, 12 Port	BI	1	4	\$332.64
672XV1510L	1/2" F1807 Ball Valve, 15 Port	BI	1	5	\$413.49
672XV1810L	1/2" F1807 Ball Valve, 18 Port	BI	1	5	\$494.34

## 1/2" F1807 Branch, Manifold

### 1" MSWT × 1" FSWT Trunk

· Do not recirculate back through any manifold branch. Do not modify manifold. Doing so will void warranty



Item Number	Item Description	Pkg Type	Min Qty	Case Qty	Price
<b>BRASS BRANCHES</b>					
672X0242	1/2" F1807, 2 Port	BI	1	10	\$38.21
672X0342	1/2" F1807, 3 Port	BI	1	10	\$53.09
672X0442	1/2" F1807, 4 Port	BI	1	10	\$67.97
672X4L-1131B3	1/2" F1807, 11 Port, 3" O.C.	BI	5	5	\$180.44
<b>BALL VALVE BRANCHES</b>					
672XV0242	1/2" F1807 Ball Valve, 2 Port	BI	1	10	\$62.35
672XV0342	1/2" F1807 Ball Valve, 3 Port	BI	1	10	\$89.30
672XV0431PK	1/2" F1807 Ball Valve, 4 Port	BI	5	5	\$116.25
672XV0442	1/2" F1807 Ball Valve, 4 Port	BI	1	10	\$116.25
672XV4L-11313	1/2" F1807 Ball Valve, 11 Port, 3" O.C.	BI	1	5	\$313.21
<b>BALANCING/BALL VALVE BRANCHES - LEADED</b>					
672XB0242	1/2" F1807 Balancing Valve, 2 Port	BI	1	10	\$109.15
672XB0342	1/2" F1807 Balancing Valve, 3 Port	BI	1	10	\$155.73
672XB0442	1/2" F1807 Balancing Valve, 4 Port	BI	1	10	\$202.30

## 1/2" F1807 Branch, Manifold

### 1" CPVC × Spun Closed Trunk

· Do not recirculate back through any manifold branch. Do not modify manifold. Doing so will void warranty



Item Number	Item Description	Pkg Type	Min Qty	Case Qty	Price
672X03C0	1/2" F1807, 3 Port	B	10	10	\$35.39
672X04C0	1/2" F1807, 4 Port	B	10	10	\$41.09
672X05C0	1/2" F1807, 5 Port	B	10	10	\$45.71
672X06C0	1/2" F1807, 6 Port	B	10	10	\$50.54
672X08C0	1/2" F1807, 8 Port	B	10	10	\$60.86
672X10C0	1/2" F1807, 10 Port	B	10	10	\$71.18
672X12C0	1/2" F1807, 12 Port	B	10	10	\$81.50

## 1/2" F1807 Branch, Multi-Port Tee

### 3/4" F1807 × Closed Trunk

Item Number	Item Description	Pkg Type	Min Qty	Case Qty	Price
<b>NL/DZR BRASS</b>					
672XGT0390	1/2" F1807, 3 Port, 1/Bag	BI	10	100	\$17.17
672XGT0490	1/2" F1807, 4 Port, 1/Bag	BI	10	100	\$21.28



672XGT0390

## 1/2" F1807 Branch, Multi-Port Tee

### 3/4" F1807 × 3/4" F1807 Trunk

Item Number	Item Description	Pkg Type	Min Qty	Case Qty	Price
<b>NL/DZR BRASS</b>					
672XGT0399	1/2" F1807, 3 Port, 1/Bag	BI	10	100	\$16.91
672XGT0499	1/2" F1807, 4 Port, 1/Bag	BI	10	100	\$21.02



672XGT0399

Supply

Drainage

Support

Specialties

Appendix

Supply



305-7095

Drainage



305-7120

Support



305-995

Specialties

Appendix

### Crimp Tool

Item Number	Item Description	Pkg Type	Min Qty	Case Qty	Price
<b>STANDARD</b>					
305-7023	1/2"- 3/4", Straight Handle	BI	1	10	\$167.94
305-7040	1", Straight Handle	BI	1	10	\$177.81
305-7050	1-1/4", Straight Handle	BI	1	10	\$187.14
305-7095	5-N-1 Combo Kit w/ Case (3/8"- 1/2"- 5/8"- 3/4"- 1") Straight Handle	BI	1	5	\$249.96
<b>COMPACT</b>					
305-7110	3/8" w/ Case	BI	1	8	\$128.42
305-7120	1/2" w/ Case	BI	1	8	\$128.42
305-7123	1/2"- 3/4" w/ Case	BI	1	8	\$163.84
305-7130	3/4" w/ Case	BI	1	8	\$128.42
<b>GO/NO-GO GAUGE</b>					
305-995	3/8", 1/2", 5/8", 3/4", 1", 1/Bag	BI	1	200	\$8.73

**Tube Stiffener**

Item Number	Item Description	Pkg Type	Min Qty	Case Qty	Price
<b>POLYPROPYLENE</b>					
603Q2	1/2", 6/Bag	Cl	15	15	\$4.40
603Q3	3/4", 6/Bag	Cl	15	15	\$7.26
603Q4	1", 6/Bag	Cl	15	15	\$9.72
<b>STAINLESS STEEL</b>					
280-A266537	1/2"	B	10	2500	\$2.35
280-A266607	3/4"	B	50	1000	\$8.85
280-A266617	1"	B	50	1000	\$10.06
280-A266627	1-1/4"	B	25	25	\$13.73



603Q2



280-A266537

Supply

Drainage

Support

Specialties

Appendix

Supply



305-999

### Crimp Ring Removal Tool

· Use only on Brass or Stainless Steel fittings

Item Number	Item Description	Pkg Type	Min Qty	Case Qty	Price
305-999	3/8" - 1"	BI	1	40	\$72.70

Drainage



305-82TX

### V-Sleeve™ Compression Tool

· Exclusively for installing Sioux Chief's V-Sleeve™ stainless steel PEX compression system

Item Number	Item Description	Pkg Type	Min Qty	Case Qty	Price
<b>STANDARD</b>					
305-802	1/2" Straight Handle	BI	1	20	\$192.00
305-804	1" Straight Handle	BI	1	10	\$212.00
<b>COMPACT</b>					
305-92TX	1/2"	BI	1	10	\$154.12
<b>GO/NO-GO GAUGE</b>					
305-85TX	1/2", 3/4", & 1"	BI	1	12	\$11.47

Support



305-92TX

Specialties



305-85TX

Appendix



304-08

### Plastic Tube Cutter

Item Number	Item Description	Pkg Type	Min Qty	Case Qty	Price
304-08	Plastic Tube And Hose Cutter - 2-1/4" Blade Length	BI	12	72	\$24.37
304-1	Replacement Blade For 304-08	BI	1	50	\$9.07
304-12	Plastic Tube And Hose Cutter - 3-1/4" Blade Length	BI	12	12	\$24.37
304-12B	Replacement Blade For 304-12	BI	12	12	\$10.52

### Ratchet Tube Cutter



304-11

Item Number	Item Description	Pkg Type	Min Qty	Case Qty	Price
304-11	Cuts 3/8" Thru 1-1/4" Diameter Tube/Pipe	BI	12	12	\$29.65
305-A139092	Cuts 1-1/4" Thru 2" Diameter Tube/Pipe	BI	1	10	\$309.26
305-A139092B	Replacement Blade for 305-A139092	BI	1	25	\$35.62



# PowerPEX<sup>®</sup> Systems for ASTM F2159

## ASTM F2159 - Fittings, Adapters & Connectors

Sioux Chief's PowerPEX<sup>®</sup> ASTM F2159 polymer fittings utilize high-performance, engineered polymer materials designed for use in potable water applications. Extensive research and testing has been performed on the quality and durability of these materials when used in potable water applications. ASTM F2159 fittings are designed for use with a copper crimp ring or the F877 V-Sleeve™, both of which provide 360° of compression around the sealing barbs. Stainless steel cinch clamps can also be used with the PowerPex ASTM F2159 fitting system.



Sioux Chief is transitioning from white fittings to black fittings for all ASTM F2159. This transition will take place through 2022 and may extend beyond. Fitting orders may include a mixture of both fitting colors if necessary.

**Note:** There are special considerations for using polymer fittings. Refer to the Sioux Chief PowerPEX installation manual for more information on limitations of polymer fitting systems.



**649X2**  
Page 43



**649TX2**  
Page 43



**649Y2**  
Page 43



**642PX2**  
Page 43



**641PX222**  
Page 44



**645PX3**  
Page 44



**640PX12**  
Page 44



**646PX3**  
Page 45



**637PX20**  
Page 45



**632PX222M**  
Page 45



**637PX25**  
Page 45

## Lead-Free Compliant



Products made from 'Copper' or 'NL/DZR' material comply with NSF-61 & 372 and with the California No Lead Plumbing Law.

## Crimp Ring

- For use with PEX SDR9 tube only
- Do not use with PB tube

### Related Products

Crimp Tool p 38

Item Number	Item Description	Pkg Type	Min Qty	Case Qty	Price
<b>COPPER</b>					
649X1	3/8" PEX	B	100	1000	\$0.34
649X2	1/2" PEX	B	100	1000	\$0.27
649X3	3/4" PEX	B	100	500	\$0.36
649X4	1" PEX	B	25	250	\$0.90



649X2

## V-Sleeve™

### PEX Compression Sleeve

Item Number	Item Description	Pkg Type	Min Qty	Case Qty	Price
<b>STAINLESS STEEL</b>					
649TX2	1/2" PEX	B	100	1000	\$0.51
649TX3	3/4" PEX	B	100	500	\$0.67
649TX4	1" PEX	B	25	250	\$1.45



649TX2

## Cinch Clamp

Item Number	Item Description	Pkg Type	Min Qty	Case Qty	Price
<b>STAINLESS STEEL</b>					
649Y1PK1	3/8" PEX, 10/Bag	BI	1	200	\$5.37
649Y2	1/2" PEX, 100/Bag	BI	1	20	\$50.20
649Y3	3/4" PEX, 100/Bag	BI	1	10	\$58.94
649Y4PK1	1" PEX, 10/Bag	BI	10	10	\$9.47



649Y2

## F2159 Poly Elbow

Item Number	Item Description	Pkg Type	Min Qty	Case Qty	Price
642PX2	1/2" x 1/2", 25/Bag	B	1	10	\$24.63
642PX3	3/4" x 3/4", 25/Bag	B	1	10	\$36.93
642PX32	3/4" x 1/2", 25/Bag	B	1	10	\$33.85
642PX4	1" x 1", 25/Bag	B	1	10	\$99.29



642PX3

Supply

Drainage

Support

Specialties

Appendix

Supply

Drainage

Support

Specialties

Appendix



641PX333



641PX322



641PX334



645PX2



640PX13

### F2159 Poly Tee

Item Number	Item Description	Pkg Type	Min Qty	Case Qty	Price
<b>STANDARD TEE</b>					
641PX222	1/2" × 1/2" × 1/2", 50/Bag	B	1	10	\$61.59
641PX333	3/4" × 3/4" × 3/4", 20/Bag	B	1	10	\$41.88
641PX444	1" × 1" × 1", 20/Bag	B	1	10	\$83.75
<b>REDUCING TEE</b>					
641PX322	3/4" × 1/2" × 1/2", 20/Bag	B	1	10	\$39.40
641PX323	3/4" × 1/2" × 3/4", 20/Bag	B	1	10	\$39.40
641PX332	3/4" × 3/4" × 1/2", 20/Bag	B	1	10	\$39.40
641PX433	1" × 3/4" × 3/4", 20/Bag	B	1	10	\$86.22
641PX434	1" × 3/4" × 1", 20/Bag	B	1	10	\$86.22
641PX442	1" × 1" × 1/2", 20/Bag	B	1	10	\$83.75
641PX443	1" × 1" × 3/4", 20/Bag	B	1	10	\$83.75
<b>BULLHEAD TEE</b>					
641PX223	1/2" × 1/2" × 3/4", 20/Bag	B	1	10	\$39.40
641PX334	3/4" × 3/4" × 1", 20/Bag	B	1	10	\$86.22

### F2159 Poly Coupling

Item Number	Item Description	Pkg Type	Min Qty	Case Qty	Price
645PX2	1/2" × 1/2", 25/Bag	B	1	20	\$17.71
645PX3	3/4" × 3/4", 25/Bag	B	1	20	\$24.63
645PX32	3/4" × 1/2", 25/Bag	B	1	20	\$28.49
645PX4	1" × 1", 25/Bag	B	1	10	\$49.27
645PX42	1" × 1/2", 25/Bag	B	1	10	\$60.03
645PX43	1" × 3/4", 25/Bag	B	1	10	\$43.10

### F2159 Poly Plug

Item Number	Item Description	Pkg Type	Min Qty	Case Qty	Price
640PX12	1/2" F2159, 50/Bag	B	1	20	\$35.53
640PX13	3/4" F2159, 25/Bag	B	1	20	\$29.89
640PX14	1" F2159, 25/Bag	B	1	10	\$42.81

**F2159 Poly Straight Adapter**

**MIP**

Item Number	Item Description	Pkg Type	Min Qty	Case Qty	Price
646PX2	1/2" F2159 × 1/2" MIP, 25/Bag	B	1	10	\$31.88
646PX23	3/4" F2159 × 1/2" MIP, 25/Bag	B	1	10	\$40.41
646PX3	3/4" F2159 × 3/4" MIP, 25/Bag	B	1	10	\$41.19
646PX32	1/2" F2159 × 3/4" MIP, 25/Bag	B	1	10	\$43.52
646PX4	1" F2159 × 1" MIP, 25/Bag	B	1	10	\$68.40



646PX3

**F2159 Poly Straight Adapter**

**FIP Swivel**

· Nose cone seal. Do not use thread sealant

Item Number	Item Description	Pkg Type	Min Qty	Case Qty	Price
637PX20	1/2" F2159 × 1/2" FIP, 50/Bag	BI	1	10	\$88.07



637PX20

**F2159 Poly Elbow Adapter**

**MIP Elbow**

Item Number	Item Description	Pkg Type	Min Qty	Case Qty	Price
632PX222M	1/2" F2159 × 1/2" MIP, 25/Bag	B	1	10	\$57.36
632PX232M	3/4" F2159 × 1/2" MIP, 25/Bag	B	1	10	\$64.22
632PX332M	3/4" F2159 × 3/4" MIP, 25/Bag	B	1	10	\$71.07



632PX232M

**F2159 Poly Elbow Adapter**

**FIP Swivel Elbow**

· Nose cone seal. Do not use thread sealant

Item Number	Item Description	Pkg Type	Min Qty	Case Qty	Price
637PX25	1/2" F2159 × 1/2" FIP Swivel, 50/Bag	B	1	10	\$138.62



637PX25

Supply

Drainage

Support

Specialties

Appendix



# **PowerPEX<sup>®</sup>** **Systems** **for ASTM F1960**

**ASTM F1960 - Brass Fittings, Adapters & Connectors**

**ASTM F1960 - Preformed Copper**

**ASTM F1960 - Valves**

**ASTM F1960 - Kits**

**ASTM F1960 Manifolds**

**ASTM F1960 - PPSU Fittings,  
Adapters & Connectors**

**ASTM F1960 - Expansion Tools**



The Sioux Chief PowerPEX<sup>®</sup> ASTM F1960 fitting system has a larger I.D., which provides higher flow rates than other insert-fitting systems. Expansion tools are used to expand the tube and F1960 PEX rings, which then shrink to compress over fitting barbs.

**Note:** All expansion joints made using PowerPEX Type-B tubing MUST be made with a self-rotating, power expansion tool to eliminate weak spots and avoid improper expansion rates.



**649W3**  
Page



**642WG3**  
Page 49



**641WG222**  
Page 49



**645WG2**  
Page 50



**645WGC2**  
Page 50



**644WG2**  
Page 51



**646WG3**  
Page 51



**647WG2E3**  
Page 52



**632WG332**  
Page 52



**630WG248E**  
Page 54



**638WG208**  
Page 54



**632W273X**  
Page 55



**631WG02**  
Page 55



**633WG18FP**  
Page 55



**648WG2FPPK1**  
Page 56



**118W206**  
Page 57



**689WG3202**  
Page 58



**672WG0490**  
Page 60



**672WGT0499**  
Page 62



**642WP3**  
Page 63



**641WP222**  
Page 63



**646WP3**  
Page 65



**637WP20**  
Page 65



**672WP0390**  
Page 66



**305-W23KIT**  
Page 67

## Male Sweat Fittings

**PRESS-FIT  
COMPATIBLE**



All Sioux Chief male sweat, preformed copper fittings are compatible with press-fit systems and all push fit systems. Do not use push fittings with nickel-plated stub outs.

## Lead-Free Compliant



Products made from 'Copper' or 'NL/DZR' material comply with NSF-61 & 372 and with the California No Lead Plumbing Law.



## F1960 Expansion Ring

· For use with PEX SDR9 tube only

### Related Products

F1960 Expansion Tools p 67

Item Number	Item Description	Pkg Type	Min Qty	Case Qty	Price
649WP2	1/2" F1960, PEX-A	B	50	1000	\$0.30
649WP3	3/4" F1960, PEX-A	B	50	500	\$0.52
649WP4	1" F1960, PEX-A	B	25	250	\$0.95
649WP5	1-1/4" F1960, PEX-A	B	10	10	\$2.17
649WP6	1-1/2" F1960, PEX-A	B	10	10	\$3.14
649WP7	2" F1960, PEX-A	B	10	10	\$5.64



649W2

## F1960 Elbow

Item Number	Item Description	Pkg Type	Min Qty	Case Qty	Price
<b>NL/DZR BRASS</b>					
642WG2	1/2" × 1/2"	B	25	25	\$8.97
642WG3	3/4" × 3/4"	B	25	25	\$17.92
642WG4	1" × 1"	B	25	25	\$24.51



642WG2

## F1960 Tee

Item Number	Item Description	Pkg Type	Min Qty	Case Qty	Price
<b>STANDARD TEE - NL/DZR BRASS</b>					
641WG222	1/2" × 1/2" × 1/2"	B	50	50	\$11.92
641WG333	3/4" × 3/4" × 3/4"	B	20	20	\$19.16
641WG444	1" × 1" × 1"	B	20	20	\$33.56
<b>REDUCING TEE - NL/DZR BRASS</b>					
641WG322	3/4" × 1/2" × 1/2"	B	20	20	\$13.78
641WG323	3/4" × 1/2" × 3/4"	B	20	20	\$15.52
641WG332	3/4" × 3/4" × 1/2"	B	20	20	\$17.11
641WG433	1" × 3/4" × 3/4"	B	20	20	\$33.56
641WG442	1" × 1" × 1/2"	B	20	20	\$33.89
641WG443	1" × 1" × 3/4"	B	20	20	\$35.16
641WG534	1-1/4" × 3/4" × 1", 1/Bag	BI	5	5	TBD
641WG543		X	5	5	TBD
641WG544		X	5	5	TBD
641WG545	1-1/4" × 1" × 1-1/4", 1/Bag	BI	5	5	TBD
<b>BULLHEAD TEE - NL/DZR BRASS</b>					
641WG223	1/2" × 1/2" × 3/4"	B	20	20	\$13.63
641WG334	3/4" × 3/4" × 1"	B	20	20	\$39.98
641WG445	1" × 1" × 1-1/4", 1/Bag	BI	5	5	TBD

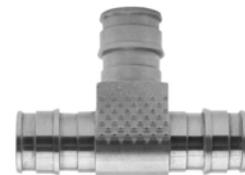

641WG222

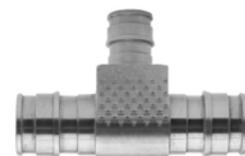

641WG332



641WG223

Supply

Drainage

Support

Specialties

Appendix



645WG2

### F1960 Coupling

Item Number	Item Description	Pkg Type	Min Qty	Case Qty	Price
<b>NL/DZR BRASS</b>					
645WG2	1/2" × 1/2"	B	100	100	\$5.81
645WG3	3/4" × 3/4"	B	50	50	\$9.26
645WG32	3/4" × 1/2"	B	50	50	\$9.99
645WG4	1" × 1"	B	25	25	\$19.03
645WG43	1" × 3/4"	B	25	25	\$16.12



645WGC5

### F1960 Straight Adapter CPVC, CTS

Item Number	Item Description	Pkg Type	Min Qty	Case Qty	Price
<b>NL/DZR BRASS CPVC CUP</b>					
645WGC2	1/2" F1960 × 1/2" CPVC	B	50	50	\$10.49
645WGC3	3/4" F1960 × 3/4" CPVC	B	50	50	\$17.93
645WGC4	1" F1960 × 1" CPVC	B	20	20	\$25.87
<b>NL/DZR CPVC CUP</b>					
645WGC5	1-1/4" F1960 × 1-1/4" CPVC - Assembly	B	5	5	\$70.70
645WGC6	1-1/2" F1960 × 1-1/2" CPVC - Assembly	B	5	5	\$91.40
645WGC7	2" F1960 × 2" CPVC - Assembly	B	5	5	\$148.08



645WGC93

### F1960 Straight Adapter CPVC - IPS Gray

Item Number	Item Description	Pkg Type	Min Qty	Case Qty	Price
<b>NL/DZR CPVC CUP</b>					
645WGC93	3/4" F1960 × 3/4" Sch 40 CPVC	B	50	50	\$18.14
645WGC94	1" F1960 × 1" Sch 40 CPVC	B	20	20	\$29.38
645WGC95	1-1/4" F1960 × 1-1/4" Sch 40 CPVC	B	10	10	\$73.29



645WG4P

### F1960 Straight Adapter PVC

Item Number	Item Description	Pkg Type	Min Qty	Case Qty	Price
<b>NL/DZR PVC CUP</b>					
645WG3P	3/4" F1960 × 3/4" PVC	B	50	50	\$15.97
645WG4P	1" F1960 × 1" PVC	B	20	20	\$29.38

## F1960 Straight Adapter

### Male Sweat

Item Number	Item Description	Pkg Type	Min Qty	Case Qty	Price
<b>NL/DZR BRASS</b>					
643WG2	1/2" F1960 × 1/2" MSWT	B	100	100	\$4.45
643WG23	3/4" F1960 × 1/2" MSWT	B	50	50	\$9.99
643WG3	3/4" F1960 × 3/4" MSWT	B	50	50	\$9.52
643WG32	1/2" F1960 × 3/4" MSWT	B	50	50	\$8.58
643WG4	1" F1960 × 1" MSWT	B	25	25	\$18.48
643WG43	3/4" F1960 × 1" MSWT	B	25	25	\$18.72
643WG5	1-1/4" F1960 × 1-1/4" MSWT	B	5	5	\$39.37
643WG6	1-1/2" F1960 × 1-1/2" MSWT	B	5	5	\$64.83
643WG7	2" F1960 × 2" MSWT	B	5	5	\$193.58



643WG2

## F1960 Straight Adapter

### Female Sweat

Item Number	Item Description	Pkg Type	Min Qty	Case Qty	Price
<b>NL/DZR BRASS</b>					
644WG2	1/2" F1960 × 1/2" FSWT	B	100	100	\$4.51
644WG23	3/4" F1960 × 1/2" FSWT	B	50	50	\$15.50
644WG3	3/4" F1960 × 3/4" FSWT	B	50	50	\$9.68
644WG32	1/2" F1960 × 3/4" FSWT	B	50	50	\$8.41
644WG4	1" F1960 × 1" FSWT	B	25	25	\$16.77
644WG5	1-1/4" F1960 × 1-1/4" FSWT	B	5	5	\$45.18
644WG6	1-1/2" F1960 × 1-1/2" FSWT	B	5	5	\$66.13
644WG7	2" F1960 × 2" FSWT	B	5	5	\$194.87



644WG2

## F1960 Straight Adapter

### MIP

Item Number	Item Description	Pkg Type	Min Qty	Case Qty	Price
<b>NL/DZR BRASS</b>					
646WG2	1/2" F1960 × 1/2" MIP	B	100	100	\$6.48
646WG3	3/4" F1960 × 3/4" MIP	B	25	25	\$12.25
646WG32	1/2" F1960 × 3/4" MIP	B	25	25	\$15.83
646WG34	1" F1960 × 3/4" MIP	B	25	25	\$25.32
646WG4	1" F1960 × 1" MIP	B	25	25	\$24.63
646WG43	3/4" F1960 × 1" MIP	B	25	25	\$23.89
646WG5	1-1/4" F1960 × 1-1/4" MIP	B	5	5	\$55.41
646WG6	1-1/2" F1960 × 1-1/2" MIP	B	5	5	\$76.70
646WG7	2" F1960 × 2" MIP	B	5	5	\$210.36



647WG2

### F1960 Straight Adapter

#### FIP

**Related Products**  
Shower Arm Test Plug p 473

Item Number	Item Description	Pkg Type	Min Qty	Case Qty	Price
<b>NL/DZR BRASS</b>					
647WG2	1/2" F1960 × 1/2" FIP	B	50	50	\$12.70
647WG23	3/4" F1960 × 1/2" FIP	B	50	50	\$14.31
647WG3	3/4" F1960 × 3/4" FIP	B	50	50	\$14.74
647WG32	1/2" F1960 × 3/4" FIP	B	25	25	\$20.37
647WG4	1" F1960 × 1" FIP	B	25	25	\$30.01
647WG43	3/4" F1960 × 1" FIP	B	25	25	\$46.16
647WG5	1-1/4" F1960 × 1-1/4" FIP	B	5	5	\$56.39
647WG6	1-1/2" F1960 × 1-1/2" FIP	B	5	5	\$114.69
647WG7	2" F1960 × 2" FIP	B	5	5	\$253.07



632WG222M

### F1960 Elbow Adapter

#### MIP

Item Number	Item Description	Pkg Type	Min Qty	Case Qty	Price
<b>NL/DZR BRASS</b>					
632WG222M	1/2" F1960 × 1/2" MIP	B	50	50	\$12.77
632WG222MPK2	1/2" F1960 × 1/2" MIP, 2/Bag	BI	10	10	\$25.84



647WG2E3

### F1960 Elbow Adapter

#### Tub/Shower Elbow

**Related Products**  
Shower Arm Test Plug p 473  
WiderSlider™ Adjustable Bracket p 533

Item Number	Item Description	Pkg Type	Min Qty	Case Qty	Price
<b>NL/DZR BRASS DROP EAR</b>					
647WG2E3	1/2" F1960 × 1/2" FIP	B	50	50	\$17.53



632WG332

### F1960 Elbow Adapter

#### Male Sweat

Item Number	Item Description	Pkg Type	Min Qty	Case Qty	Price
<b>NL/DZR BRASS</b>					
632WG332	3/4" F1960 × 3/4" MSWT	B	25	25	\$12.37

## F1960 Elbow Adapter

### Female Sweat

· One-piece no lead brass

Item Number	Item Description	Pkg Type	Min Qty	Case Qty	Price
<b>NL/DZR BRASS</b>					
632WG335	3/4" F1960 × 3/4" FSWT	B	25	25	\$15.48



632WG335

## Wal-Let™ - F1960

### Wall Termination Fitting

Item Number	Item Description	Pkg Type	Min Qty	Case Qty	Price
<b>LEADED</b>					
615W216	1/2" FIP × 1/2" F1960	B	25	25	\$27.16



615W216

Supply

Drainage

Support

Specialties

Appendix

Supply



630WG248

### F1960 Stub Out Elbow

Item Number	Item Description	Pkg Type	Min Qty	Case Qty	Price
630WG2138	1/2" F1960, 13" x 8"	B	50	50	\$18.38
630WG2412	1/2" F1960, 4" x 12"	B	50	50	\$17.27
630WG248	1/2" F1960, 4" x 8"	B	50	50	\$11.22
630WG248PK1	1/2" F1960, 4" x 8", 10/Box	BI	10	10	\$11.47
630WG348	3/4" F1960, 5" x 8"	B	25	25	\$25.88
630WG4612	1" F1960, 6" x 12"	B	25	25	\$45.22

Drainage

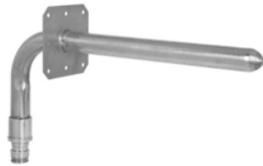

630WG248E

### F1960 Stub Out Elbow Square O Strap

Item Number	Item Description	Pkg Type	Min Qty	Case Qty	Price
630WG248E	1/2" F1960, 4" x 8" w/ Strap	B	25	25	\$12.41
630WG248EPK1	1/2" F1960, 4" x 8" w/Strap, 10/Box	BI	10	10	\$12.66
630WG348E	3/4" F1960, 5" x 8" w/ Strap	B	25	25	\$27.47
630WG4612E	1" F1960, 6" x 12" w/ Strap	B	10	10	\$46.78

Support

Specialties



630WGD288E

### F1960 Stub Out Elbow Double Stub Out

**Related Products**

3-Valve Kitchen Supply Box p 179

Item Number	Item Description	Pkg Type	Min Qty	Case Qty	Price
630WGD288E	1/2" F1960, 8" x 8" x 8" w/ Strap	B	25	25	\$29.45

Appendix



638WG212E

### F1960 Bullet™

· Not to be used as permanent air chambers

Item Number	Item Description	Pkg Type	Min Qty	Case Qty	Price
<b>STANDARD</b>					
638WG208	1/2" F1960, 8"	B	50	50	\$11.61
638WG215	1/2" F1960, 15"	B	50	50	\$21.78
<b>SPUN CLOSED WITH STRAP</b>					
638WG212E	1/2" F1960, 12" Long, 8" Stub Out	B	50	50	\$18.78

## F1960 Tub/Shower Pressure Connector

· DO NOT use pipe dope on FIP swivel threads

Item Number	Item Description	Pkg Type	Min Qty	Case Qty	Price
632W273X	1/2" F1960 × 1/2" MIP Swivel, 7" × 3"	B	50	50	\$17.65
632WG263	1/2" F1960 × 1/2" MSWT, 6" × 2-1/4"	B	50	50	\$10.53
632WG263Y	1/2" F1960 × 1/2" FIP Swivel, 6" × 3"	B	50	50	\$14.38



632W273X

## F1960 Water Heater Connector

### FIP Swivel Elbow

· DO NOT use pipe dope on FIP swivel threads

Item Number	Item Description	Pkg Type	Min Qty	Case Qty	Price
<b>STANDARD</b>					
631WG02	3/4" F1960 × 3/4" FIP Swivel	B	25	25	\$19.26
<b>VALVED, FULL PORT</b>					
631WG02FP	3/4" F1960 × 3/4" FIP Swivel	B	12	12	\$54.26



631WG02



631WG02FP

## F1960 Water Heater Connector

### FIP Swivel Straight

· DO NOT use pipe dope on FIP swivel threads

Item Number	Item Description	Pkg Type	Min Qty	Case Qty	Price
<b>STANDARD</b>					
633WG18	3/4" F1960 × 3/4" FIP Swivel, 18"	B	25	25	\$27.78
633WG18PK1	3/4" PEX F1960 × 3/4" FIP Swivel, 18", 10/Box	BI	10	10	\$28.03
<b>VALVED, FULL PORT</b>					
633WG18FP	3/4" F1960 × 3/4" FIP Swivel, 18"	B	10	10	\$62.78
633WG18FPT	3/4" F1960 × 3/4" FIP Swivel, w/ 3/4" FIP Branch, 18"	B	10	10	\$76.78
633WG306FP	3/4" PEX F1960 × 3/4" FIP Swivel, 6"	B	10	10	\$51.26
<b>THERMAL EXPANSION VALVE, FULL PORT</b>					
633WG18FRV	3/4" F1960 × 3/4" FIP Swivel, w/ Pressure Relief 3/8" Comp., 18"	B	10	10	\$72.78
633WG18HRV	3/4" F1960 × 3/4" FIP Swivel, w/ Pressure Relief 3/8" Hose Barb, 18"	B	10	10	\$72.78
633WG18WRV	3/4" F1960 × 3/4" FIP Swivel, w/ Pressure Relief 1/2" F1960, 18"	B	10	10	\$72.78
<b>ADJUSTABLE REPLACEMENT RELIEF PORT</b>					
648-ARW	1/8" MIP × 1/2" F1960, 80-125 PSI	BI	6	6	\$10.30



633WG18

Supply

Drainage

Support

Specialties

Appendix



634WG418



634WG418FP



648WG2FPPK1



648WG5FP



648-3SW



648WG3WRV

## F1960 Water Heater Connector

### Flexible Copper FIP Swivel

- DO NOT use pipe dope on FIP swivel threads
- Do not twist or kink flexible connector

Item Number	Item Description	Pkg Type	Min Qty	Case Qty	Price
<b>STANDARD</b>					
634WG418	3/4" F1960 × 3/4" FIP Swivel, 18"	B	25	25	\$24.69
<b>VALVED, FULL PORT</b>					
634WG418FP	3/4" F1960 × 3/4" FIP Swivel, 18"	B	25	25	\$59.69

## F1960 Brass Ball Valve

Item Number	Item Description	Pkg Type	Min Qty	Case Qty	Price
<b>STANDARD</b>					
648WG2FPPK1	1/2" F1960	BI	10	100	\$13.67
648WG3FPPK1	3/4" F1960	BI	10	100	\$28.52
648WG4FPPK1	1" F1960	BI	12	60	\$43.37
<b>FULL PORT</b>					
648WG5FP	1-1/4" F1960	B	5	5	\$162.66
648WG6FP	1-1/2" F1960	B	1	1	\$216.56
648WG7FP	2" F1960	B	1	1	\$354.14
<b>FULL PORT WITH DRAIN</b>					
648WG2FPD	1/2" F1960	B	10	10	\$47.01
648WG3FPD	3/4" F1960	B	6	6	\$66.28
<b>FULL PORT FIPS X F1960</b>					
648-3SW	3/4" FIPS x 3/4" F1960	BI	5	5	\$28.00
<b>THERMAL EXPANSION VALVE - 125 PSI</b>					
648WG3WRV	3/4" F1960 × 3/4" F1960, 1/2" F1960 Port	BI	6	6	\$45.00



## F1960 Brass Ball Valve

### Female Sweat

Item Number	Item Description	Pkg Type	Min Qty	Case Qty	Price
<b>FULL PORT</b>					
648WG-2	1/2" F1960 × 1/2" FSWT	BI	6	108	\$11.62
648WG-3	3/4" F1960 × 3/4" FSWT	BI	6	72	\$20.02
648WG-4	1" F1960 × 1" FSWT	BI	6	36	\$25.24



648WG-3

## F1960 Sillcock

Item Number	Item Description	Pkg Type	Min Qty	Case Qty	Price
<b>LEADED</b>					
117W2	1/2" F1960	BI	10	100	\$21.36



117W2

## F1960 Frost-Proof Anti-Siphon Sillcock

### Related Products

Frost-Proof Sillcock Replacement Parts p 114

Item Number	Item Description	Pkg Type	Min Qty	Case Qty	Price
<b>MULTI-TURN - LEADED</b>					
118W204	1/2" F1960 × 3/4" MHT, 4"	BI	1	40	\$32.80
118W206	1/2" F1960 × 3/4" MHT, 6"	BI	1	40	\$34.07
118W208	1/2" F1960 × 3/4" MHT, 8"	BI	1	40	\$34.70
118W210	1/2" F1960 × 3/4" MHT, 10"	BI	1	40	\$36.79
118W212	1/2" F1960 × 3/4" MHT, 12"	BI	1	40	\$38.05



118W208

Supply

Drainage

Support

Specialties

Appendix



689WG2201

### F1960 Stub Out Kit

#### 1/2" Water Closet Stub Out With Bracket

· For individual product details, see product pages

Item Number	Item Description	Pkg Type	Min Qty	Case Qty	Price
<b>16" STUD BAYS</b>					
689WG2201	(1) 525-1612, (1) 630WG248	BI	12	12	\$16.68
<b>24" STUD BAYS</b>					
689WG2211	(1) 525-2412, (1) 630WG248	BI	12	12	\$17.43



689WG3202

### F1960 Stub Out Kit

#### 1/2" Lav/Sink Stub Outs With Bracket

· For individual product details, see product pages

Item Number	Item Description	Pkg Type	Min Qty	Case Qty	Price
<b>16" STUD BAYS</b>					
689WG3202	(1) 525-1622, (2) 630WG248	BI	12	12	\$29.24
<b>24" STUD BAYS</b>					
689WG3212	(1) 525-2422, (2) 630WG248	BI	12	12	\$29.98



689WG211

### F1960 Stub Out Kit

#### StopOut™

Item Number	Item Description	Pkg Type	Min Qty	Case Qty	Price
689WG11	1/2" 1960 x (1) 3/8" Comp.	B	10	10	\$23.31
689WG201	1/2" F1960 x (1) 1/4" Comp. (1) 3/8" Comp.	B	10	10	\$40.29
689WG211	1/2" F1960 x (2) 3/8" Comp.	B	10	10	\$40.29



689WG2291

### F1960 Stub Out Kit

#### 1/2" Shower Riser Elbow With Bracket

· For individual product details, see product pages

#### Related Products

Shower WallNut™ p 640

Item Number	Item Description	Pkg Type	Min Qty	Case Qty	Price
689WG2291	(1) 525-16WLB, (1) 630WG248	BI	12	12	\$18.14

## F1960 Stub Out Kit

### 3/4" Water Heater Stub Outs With Bracket

· For individual product details, see product pages

Item Number	Item Description	Pkg Type	Min Qty	Case Qty	Price
689WG5103	(1) 525-1623, (2) 630WG348	BI	12	12	\$59.93

## F1960 Water Heater Connector Kit

· DO NOT use pipe dope on FIP swivel threads  
 · For individual product details, see product pages

Item Number	Item Description	Pkg Type	Min Qty	Case Qty	Price
694WG71022091	(1)631WG02FP, (1)633-G3TM15, (1)633WG18	BI	10	10	\$123.44



689WG5103



694WG71022091

Supply

Drainage

Support

Specialties

Appendix



**1/2" F1960 Branch, Manifold**  
**3/4" F1960 x Spun Closed Trunk**

- Do not recirculate back through any manifold branch. Do not modify manifold. Doing so will void warranty
- Branches are 1-1/2" on-center

Item Number	Item Description	Pkg Type	Min Qty	Case Qty	Price
672WG0490	1/2" F1960, 4 Port	BI	10	10	\$65.24
672WG0690	1/2" F1960, 6 Port	BI	10	10	\$90.87
672WG0890	1/2" F1960, 8 Port	BI	10	10	\$116.49



**1/2" F1960 Branch, Manifold**  
**3/4" F1960 x 3/4" F1960 Trunk**

- Do not recirculate back through any manifold branch. Do not modify manifold. Doing so will void warranty
- Branches are 1-1/2" on-center

Item Number	Item Description	Pkg Type	Min Qty	Case Qty	Price
672WG0499	1/2" F1960, 4 Port	BI	10	10	\$70.09
672WG0699	1/2" F1960, 6 Port	BI	10	10	\$95.72
672WG0899	1/2" F1960, 8 Port	BI	10	10	\$121.34



**1/2" F1960 Branch, Manifold**  
**3/4" MSWT x Spun Closed Trunk**

- Do not recirculate back through any manifold branch. Do not modify manifold. Doing so will void warranty
- Non-valved branches are 1-1/2" on-center. Valved branches are 2" on-center

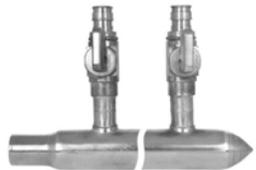

Item Number	Item Description	Pkg Type	Min Qty	Case Qty	Price
<b>STANDARD</b>					
672WG0430	1/2 F1960, 4 Port	BI	1	10	\$64.92
672WG0630	1/2 F1960, 6 Port	BI	1	10	\$90.87
672WG0830	1/2 F1960, 8 Port	BI	1	10	\$116.49
<b>BALL VALVE BRANCHES</b>					
672WV0230	1/2" F1960, 2 Port	BI	1	10	\$65.36
672WV0330	1/2" F1960, 3 Port	BI	1	10	\$91.26
672WV0430	1/2" F1960, 4 Port	BI	1	10	\$117.16
672WV0630	1/2" F1960, 6 Port	BI	1	10	\$168.96
672WV0830	1/2" F1960, 8 Port	BI	1	10	\$220.76
672WV1030	1/2" F1960, 10 Port	BI	1	10	\$272.56
672WV1230	1/2" F1960, 12 Port	BI	1	4	\$324.36

## 1/2" F1960 Branch, Manifold

### 1" MSWT x Spun Closed Trunk

- Do not recirculate back through any manifold branch. Do not modify manifold. Doing so will void warranty
- Branches are 1-1/2" on-center



Item Number	Item Description	Pkg Type	Min Qty	Case Qty	Price
672WG0240	1/2" F1960, 2 Port	BI	1	10	\$33.98
672WG0340	1/2" F1960, 3 Port	BI	1	10	\$46.79
672WG0440	1/2" F1960, 4 Port	BI	1	10	\$59.60
672WG0640	1/2" F1960, 6 Port	BI	1	10	\$85.23
672WG0840	1/2" F1960, 8 Port	BI	1	10	\$110.85
672WG1040	1/2" F1960, 10 Port	BI	1	10	\$136.48
672WG1240	1/2" F1960, 12 Port	BI	1	10	\$162.10

## 1/2" F1960 Branch, Manifold

### 1" CPVC x Spun Closed Trunk

- Do not recirculate back through any manifold branch. Do not modify manifold. Doing so will void warranty
- Branches are 1-1/2" on-center



Item Number	Item Description	Pkg Type	Min Qty	Case Qty	Price
672WG03C0	1/2" F1960, 3 Port	BI	10	10	\$58.45
672WG04C0	1/2" F1960, 4 Port	BI	10	10	\$71.27
672WG06C0	1/2" F1960, 6 Port	BI	10	10	\$96.90
672WG08C0	1/2" F1960, 8 Port	BI	10	10	\$122.52

## 1/2" F1960 Branch, Manifold

### 1" MSWT x 1" MSWT Trunk

Item Number	Item Description	Pkg Type	Min Qty	Case Qty	Price
<b>BALL VALVE BRANCHES</b>					
672WV0444	1/2" F1960, 4 Port	BI	1	10	\$110.73
672WV0644	1/2" F1960, 6 Port	BI	1	10	\$162.53
672WV0844	1/2" F1960, 8 Port	BI	1	10	\$214.33
672WV1044	1/2" F1960 10 Port	BI	1	10	\$266.13



Supply

Drainage

Support

Specialties

Appendix



672WGT0390

**1/2" F1960 Branch, Multi-Port Tee**

**3/4" F1960 PEX x Closed Trunk**

Item Number	Item Description	Pkg Type	Min Qty	Case Qty	Price
<b>NL/DZR BRASS</b>					
672WGT0390	1/2" F1960, 3 Port, 1/Bag	BI	10	100	\$31.98
672WGT0490	1/2" F1960, 4 Port, 1/Bag	BI	10	100	\$40.38



672WGT0499

**1/2" F1960 Branch, Multi-Port Tee**

**3/4" F1960 PEX x 3/4" F1960 PEX Trunk**

Item Number	Item Description	Pkg Type	Min Qty	Case Qty	Price
<b>NL/DZR BRASS</b>					
672WGT0399	1/2" F1960, 3 Port, 1/Bag	BI	10	100	\$32.86
672WGT0499	1/2" F1960, 4 Port, 1/Bag	BI	10	100	\$41.26

## F1960 Expansion Ring

· For use with PEX SDR9 tube only

### Related Products

F1960 Expansion Tools p 67

Item Number	Item Description	Pkg Type	Min Qty	Case Qty	Price
649WP2	1/2" F1960, PEX-A	B	50	1000	\$0.30
649WP3	3/4" F1960, PEX-A	B	50	500	\$0.52
649WP4	1" F1960, PEX-A	B	25	250	\$0.95
649WP5	1-1/4" F1960, PEX-A	B	10	10	\$2.17
649WP6	1-1/2" F1960, PEX-A	B	10	10	\$3.14
649WP7	2" F1960, PEX-A	B	10	10	\$5.64



649W2

## F1960 Poly Elbow

Item Number	Item Description	Pkg Type	Min Qty	Case Qty	Price
642WP2	1/2" x 1/2"	B	25	625	\$2.48
642WP3	3/4" x 3/4"	B	25	375	\$3.17
642WP4	1" x 1"	B	10	160	\$6.46
642WP5	1-1/4" X 1-1/4"	BI	1	5	\$12.88
<b>642WP6</b>	<b>1-1/2" X 1-1/2"</b>	BI	1	5	\$19.60
642WP7	2" X 2"	BI	1	5	\$58.79



642WP3

## F1960 Poly Tee

Item Number	Item Description	Pkg Type	Min Qty	Case Qty	Price
<b>STANDARD TEE</b>					
641WP222	1/2" x 1/2" x 1/2"	B	25	500	\$2.48
641WP333	3/4" x 3/4" x 3/4"	B	25	200	\$4.13
641WP444	1" x 1" x 1"	B	10	100	\$7.44
641WP555	1-1/4" x 1-1/4" x 1-1/4"	BI	1	5	\$17.92
641WP666	1-1/2" x 1-1/2" x 1-1/2"	BI	1	5	\$36.69
641WP777	2" x 2" x 2"	BI	1	5	\$85.84
<b>REDUCING TEE</b>					
641WP322	3/4" x 1/2" x 1/2"	B	25	300	\$3.88
641WP323	3/4" x 1/2" x 3/4"	B	25	250	\$3.88
641WP332	3/4" x 3/4" x 1/2"	B	25	250	\$3.28
641WP433	1" x 3/4" x 3/4"	B	10	140	\$7.20
641WP434	1" x 3/4" x 1"	B	10	120	\$7.09
641WP442	1" x 1" x 1/2"	B	10	150	\$6.98
641WP443	1" x 1" x 3/4"	B	10	120	\$7.55
<b>641WP535</b>	<b>1-1/4" x 3/4" x 1-1/4"</b>	BI	1	5	\$13.39
641WP543	1-1/4" x 1" x 3/4"	BI	1	5	\$17.38
641WP544	1-1/4" x 1" x 1"	BI	1	5	\$17.50
<b>641WP545</b>	<b>1-1/4" x 1" x 1-1/4"</b>	BI	1	5	\$17.56
641WP552	1-1/4" x 1-1/4" x 1/2"	BI	1	5	\$15.54
641WP553	1-1/4" x 1-1/4" x 3/4"	BI	1	5	\$17.16
641WP554	1-1/4" x 1-1/4" x 1"	BI	1	5	\$17.29



641WP222

Supply

Drainage

Support

Specialties

Appendix



641WP332



641WP223

### F1960 Poly Tee (Cont)

Item Number	Item Description	Pkg Type	Min Qty	Case Qty	Price
<b>REDUCING TEE</b>					
641WP636	1-1/2" x 3/4" x 1-1/2"	BI	1	5	\$18.47
641WP646	1-1/2" x 1" x 1-1/2"	BI	1	5	\$18.43
641WP654	1-1/2" x 1-1/4" x 1"	BI	1	5	\$19.02
641WP655	1-1/2" x 1-1/4" x 1-1/4"	BI	1	5	\$25.91
641WP656	1-1/2" x 1-1/4" x 1-1/2"	BI	1	5	\$26.10
641WP663	1-1/2" x 1-1/2" x 3/4"	BI	1	5	\$20.85
641WP664	1-1/2" x 1-1/2" x 1"	BI	1	5	\$21.71
641WP665	1-1/2" x 1-1/2" x 1-1/4"	BI	1	5	\$25.91
641WP747	2" x 1" x 2"	BI	1	5	\$63.56
641WP757	2" x 1-1/4" x 2"	BI	1	5	\$63.21
641WP764	2" x 1-1/2" x 1"	BI	1	5	\$71.87
641WP773	2" x 2" x 3/4"	BI	1	5	\$77.03
641WP774	2" x 2" x 1"	BI	1	5	\$77.17
641WP775	2" x 2" x 1-1/4"	BI	1	5	\$80.71
641WP776	2" x 2" x 1-1/2"	BI	1	5	\$82.21
<b>BULLHEAD TEE</b>					
641WP223	1/2" x 1/2" x 3/4"	B	25	300	\$3.88
641WP334	3/4" x 3/4" x 1"	B	10	140	\$7.36

### F1960 Poly Coupling



645WP2



645WP32

Item Number	Item Description	Pkg Type	Min Qty	Case Qty	Price
645WP2	1/2" x 1/2"	B	25	1000	\$1.99
645WP3	3/4" x 3/4"	B	25	500	\$2.55
645WP32	3/4" x 1/2"	B	25	500	\$4.32
645WP4	1" x 1"	B	10	200	\$4.13
645WP42	1" x 1/2"	B	25	250	\$5.95
645WP43	1" x 3/4"	B	25	250	\$6.19
645WP5	1-1/4" X 1-1/4"	BI	1	5	\$10.34
645WP53	1-1/4" X 3/4"	BI	1	5	\$9.65
<b>645WP54</b>	1-1/4" x 1"	BI	1	5	\$10.44
645WP6	1-1/2" X 1-1/2"	BI	1	5	\$18.00
645WP65	1-1/2" X 1-1/4"	BI	1	5	\$15.31
645WP7	2" X 2"	BI	1	5	\$37.57
645WP76	2" X 1-1/2"	BI	1	5	\$31.70

### F1960 Poly Plug



640WP02

Item Number	Item Description	Pkg Type	Min Qty	Case Qty	Price
640WP02	1/2" F1960	B	25	1000	\$1.58
640WP03	3/4" F1960	B	25	750	\$2.49
640WP04	1" F1960	B	10	360	\$3.21
640WP5	1-1/4" F1960	BI	1	5	\$10.08
640WP6	1-1/2" F1960	BI	1	5	\$20.72
640WP7	2" F1960	BI	1	5	\$35.73



### F1960 Poly Straight Adapter

#### MIP

Item Number	Item Description	Pkg Type	Min Qty	Case Qty	Price
646WP2	1/2" F1960 × 1/2" MIP	B	25	800	\$3.16
646WP3	3/4" F1960 × 3/4" MIP	B	25	500	\$3.39
646WP32	1/2" F1960 × 3/4" MIP	B	10	400	\$3.71
646WP3PK2	3/4" F1960 × 3/4" MIP, 2/Bag	BI	10	10	\$7.08
646WP4	1" F1960 × 1" MIP	B	10	200	\$6.67



646WP3

### F1960 Poly Elbow Adapter

#### MIP

Item Number	Item Description	Pkg Type	Min Qty	Case Qty	Price
632WP222M	1/2" F1960 × 1/2" MIP	B	25	375	\$4.37



632WP222M

### F1960 Poly Faucet Adapter

Item Number	Item Description	Pkg Type	Min Qty	Case Qty	Price
<b>1/2" FIP SWIVEL - STRAIGHT</b>					
637WP20	1/2" F1960	B	25	500	\$4.37
<b>1/2" FIP SWIVEL - ELBOW</b>					
637WP25	1/2" F1960	B	25	375	\$5.40



637WP20



637WP25

Supply

Drainage

Support

Specialties

Appendix

Supply



672WP0390

**1/2" F1960 Branch, Poly Manifold**

**3/4" F1960 x Closed Trunk**

Item Number	Item Description	Pkg Type	Min Qty	Case Qty	Price
672WP0290		BI	10	50	\$10.35
672WP0390	1/2" F1960, 3 Port	BI	10	140	\$13.99
672WP0490	1/2" F1960, 4 Port	BI	10	100	\$17.24
672WP0690	1/2" F1960, 6 Port	BI	10	60	\$23.96

Drainage

Support



672WP0699

**1/2" F1960 Branch, Poly Manifold**

**3/4" F1960 x 3/4" F1960 Trunk**

Item Number	Item Description	Pkg Type	Min Qty	Case Qty	Price
672WP0299	1/2" F1960, 2 Port	BI	10	140	\$10.73
672WP0399	1/2" F1960, 3 Port	BI	10	140	\$14.09
672WP0499	1/2" F1960, 4 Port	BI	10	100	\$17.45
672WP0699	1/2" F1960, 6 Port	BI	10	60	\$24.16

Specialties

Appendix



672WP0670

**1/2" F1960 Branch, Poly Manifold**

**1" F1960 x Closed Trunk**

Item Number	Item Description	Pkg Type	Min Qty	Case Qty	Price
672WP0470	1/2" F1960, 4 Port	BI	10	100	\$17.65
672WP0670	1/2" F1960, 6 Port	BI	10	60	\$24.37



672WP0677

**1/2" F1960 Branch, Poly Manifold**

**1" F1960 x 1" F1960 Trunk**

Item Number	Item Description	Pkg Type	Min Qty	Case Qty	Price
672WP0477	1/2" F1960, 4 Port	BI	10	100	\$18.25
672WP0677	1/2" F1960, 6 Port	BI	10	60	\$25.10



672WPT0699

**1/2" F1960 Branch, Poly Multi-Port Tee**

**3/4" F1960 x 3/4" F1960 Trunk**

Item Number	Item Description	Pkg Type	Min Qty	Case Qty	Price
672WPT0399	1/2" F1960, 3 Port	BI	10	10	\$20.87
672WPT0499	1/2" F1960, 4 Port	BI	10	10	\$26.52
672WPT0699	1/2" F1960, 6 Port	BI	10	10	\$37.54

**F1960 Tools**

· To insure a proper joint, Sioux Chief suggests the use of a power rotating tool

Item Number	Item Description	Pkg Type	Min Qty	Case Qty	Price
<b>EXPANSION TOOL</b>					
305-W23KIT	F1960 Standard Tool Kit w/ 1/2" & 3/4" Heads	BI	1	5	\$457.50
305-WT	F1960 Pipe Expander Tool Only	BI	1	10	\$254.32
<b>EXPANDER HEADS</b>					
305-W2H	1/2"	BI	1	20	\$97.84
305-W3H	3/4"	BI	1	20	\$97.84
305-W4H	1"	BI	1	20	\$97.84



305-W23KIT



305-W2H

Supply

Drainage

Support

Specialties

Appendix



# PowerPEX<sup>®</sup> Systems for ASTM F3347

**ASTM F3347 - Fittings & Valves**

**ASTM F3347 - Kits**

All Sioux Chief PowerPEX<sup>®</sup> ASTM F3347 PEX fittings are manufactured to the ASTM F3347 standard.

**Note:** A properly calibrated, press sleeve tool **MUST** be used to connect PEX tubing to an ASTM F3347 PEX fitting. Be sure tubing is cut squarely, tube is inserted into sleeve completely and fitting is inserted fully into tube.

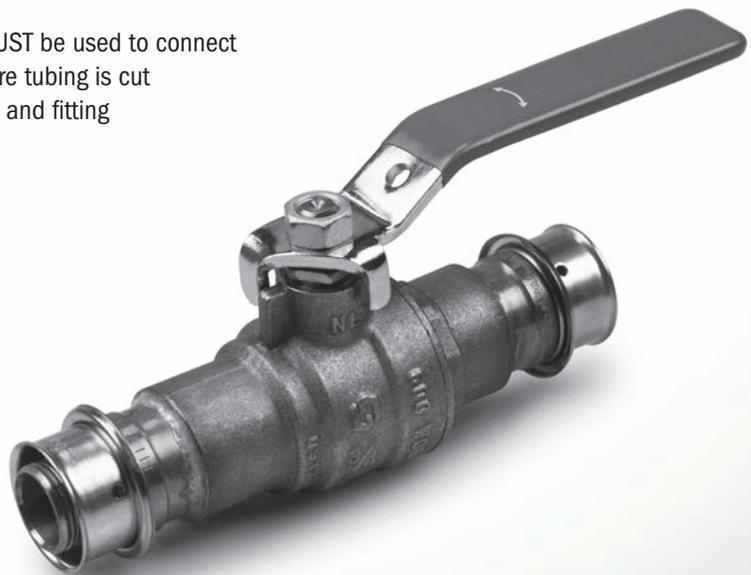



**645VGC4**  
Page 71



**630VG248**  
Page 71



**630VG248E**  
Page 71



**638VG208E4**  
Page 71



**632VG273**  
Page 71



**633VG18**  
Page 72



**633VG18FP**  
Page 72



**648VG3FP**  
Page 72



**689VG3202**  
Page

## Male Sweat Fittings

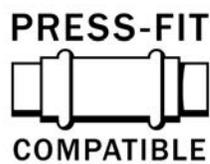

All Sioux Chief male sweat, preformed copper fittings are compatible with press-fit systems and all push fit systems. Do not use push fittings with nickel-plated stub outs.

## Lead-Free Compliant



Products made from 'Copper' or 'NL/DZR' material comply with NSF-61 & 372 and with the California No Lead Plumbing Law.

**F3347 Straight Adapter**

**CPVC, CTS**

Item Number	Item Description	Pkg Type	Min Qty	Case Qty	Price
<b>NL/DZR CPVC CUP</b>					
645VGC2	1/2" F3347 PEX Press × 1/2" CPVC	B	50	50	\$11.92
645VGC3	3/4" F3347 PEX Press × 3/4" CPVC	B	50	50	\$21.92
645VGC4	1" F3347 PEX Press × 1" CPVC	B	20	20	\$36.10



645VGC4

**F3347 Stub Out Elbow**

Item Number	Item Description	Pkg Type	Min Qty	Case Qty	Price
630VG248	1/2" F3347 PEX Press, 3-1/2" × 8"	B	25	25	\$13.67



630VG248

**F3347 Stub Out Elbow**

**Square O Strap**

Item Number	Item Description	Pkg Type	Min Qty	Case Qty	Price
630VG248E	1/2" F3347 PEX Press, 3-1/2" × 8", w/ Strap	B	25	25	\$14.74



630VG248E

**F3347 Bullet™**

**Spun Closed w/ Square O Strap**

· Not to be used as permanent air chambers

Item Number	Item Description	Pkg Type	Min Qty	Case Qty	Price
638VG208E4	1/2" F3347 PEX Press, 8" Long, 4" Stub Out	B	25	25	\$15.60
638VG218E4	1/2" F3347 PEX Press, 18" Long, 14" Stub Out	B	25	25	\$20.87



638VG208E4

**F3347 Tub/Shower Pressure Connector**

Item Number	Item Description	Pkg Type	Min Qty	Case Qty	Price
632VG273	1/2" F3347 PEX Press × 1/2" MSWT, 7" × 3"	B	50	50	\$12.42



632VG273

Supply

Drainage

Support

Specialties

Appendix



## F3347 Water Heater Connector

### FIP Swivel Straight

· DO NOT use pipe dope on FIP swivel threads

Item Number	Item Description	Pkg Type	Min Qty	Case Qty	Price
<b>STANDARD</b>					
633VG18	3/4" F3347 PEX Press × 3/4" FIP Swivel, 18"	B	10	10	\$35.53
<b>VALVED, FULL PORT</b>					
633VG18FP	3/4" F3347 PEX Press × 3/4" FIP Swivel, Full Port	B	10	10	\$70.53

## F3347 Brass Ball Valve

Item Number	Item Description	Pkg Type	Min Qty	Case Qty	Price
<b>FULL PORT</b>					
648VG2FP	1/2" F3347 PEX Press	B	10	10	\$45.42
648VG3FP	3/4" F3347 PEX Press	B	10	10	\$69.49
648VG4FP	1" F3347 PEX Press	B	10	10	\$115.56



## F3347 Stub Out Kit

### 1/2" Lav/Sink Stub Outs With Bracket

· For individual product details, see product pages

Item Number	Item Description	Pkg Type	Min Qty	Case Qty	Price
	<b>24" STUD BAY</b>				
689VG3212	(1) 525-2422, (2) 630VG248	BI	12	12	\$34.88

Supply

Drainage

Support

Specialties

Appendix



# **Specialized Supply**

**for CPVC Systems**

**for PVC Systems**

**for Sweat/Copper**

**PDQ™ Push Fit  
Systems**

**Pipe  
Insulation**

# Specialized Supply

## CPVC Systems

Sioux Chief CPVC fittings conform to *ASTM D2846 Standard Specification for Chlorinated Polyvinyl Chloride (CPVC) Plastic Hot and Cold Water Distribution Systems* and are designed for use with CTS (copper tube size) CPVC pipe and fittings conforming to ASTM D2846.

Sioux Chief also offers CPVC fittings for the ASTM F438 system that are designed for use with IPS (iron pipe size) CPVC pipe and fittings which conform to ASTM F438

A select group of our transition fittings have been tested and certified by CSA to the ASTM D2846 Standard and CSA Standard B137.6 and/or IAPMO listed.

## PVC Systems

Sioux Chief PVC fittings conform to the *ASTM F1970 Standard Specification for Special Engineered Fittings, Appurtenances or Valves for use in Polyvinyl Chloride (PVC) or Chlorinated Polyvinyl Chloride (CPVC) Systems* and are designed for use with Sch. 40 PVC pipe conforming to ASTM D1785.

## Sweat/Copper Systems

Sioux Chief Rough-in Ready™ preformed copper fittings for sweat are made in the USA from 100% pure copper tube that conforms to the following specifications:

Tube: ASTM B88 and Fitting Ends: ANSI B16.22

## PDQ™ Push Fit System

Sioux Chief PDQ™ push-fittings are made to the *ASSE 1061 Performance Requirements for Push-Fit Fittings*.

PDQ™ fittings are removable, can be rotated after installation, and are approved for underground and sealed wall applications.

All PDQ™ fittings are tested to ASSE 1061/NSF 61 standards and are IAPMO listed to cUPC.

## Pipe Insulation

Sioux Chief's closed-cell foam insulation is made in the USA and provides the ideal combination of flexibility and rigidity for easier installation.

# CTS CPVC Systems

## CPVC Fittings, Adapters & Connectors

## CPVC Preformed Copper & Valves

Sioux Chief offers the most complete line of CPVC transition fittings in the industry. Our fittings are compatible with FlowGuard Gold® pipe/fittings and are FGG/BM/CZ™ System compatible. All fittings are 100% production tested to ensure maximum quality and a leak-free connection.

**Important Notes About Sioux Chief CPVC Fittings:**

Do not cut, or modify any Sioux Chief CPVC transition fitting (except 630-C series fittings).

Do not expose CPVC transition area of fitting to heat in excess of 180°F.

Never install a damaged fitting.

See complete installation instructions at  
[www.siouxchief.com](http://www.siouxchief.com)



FBC™ System Compatible indicates that this product has been tested, and is monitored on an ongoing basis, to assure its chemical compatibility with FlowGuard Gold®, BlazeMaster® and Corzan® piping systems and products made with TempRite® Technology. The FBC System Compatible Logo, FBC™, FlowGuard Gold®, BlazeMaster®, Corzan®, and TempRite® are trademarks of Lubrizol Advanced Materials, Inc. or its affiliates.



**645XC3**  
Page 79



**645WGC2**  
Page 79



**645VGC3**  
Page 79



**643-C311**  
Page 80



**646-CG2**  
Page 80



**647-CG6**  
Page 80



**685-C4**  
Page 81



**647-C2DW**  
Page



**633-C02**  
Page 81



**647-CG2E3**  
Page 81



**615-C215**  
Page 82



**630-C248**  
Page 83



**632-C263X**  
Page 83



**631-CG307FP**  
Page 84



**633-CG24FP**  
Page



**634-C118**  
Page 84



**648-CG2FP**  
Page 85



**118-C208**  
Page 86



**689C1102**  
Page 87



**645XC93**  
Page 91



**643-C9418**  
Page 91



**646-CG96**  
Page 91



**645WG3P**  
Page 95



**647-PG5**  
Page 96



**648-PG3FP**  
Page 97

## Male Sweat Fittings

### PRESS-FIT



### COMPATIBLE

All Sioux Chief male sweat, preformed copper fittings are compatible with press-fit systems and all push fit systems. Do not use push fittings with nickel-plated stub outs.

## Lead-Free Compliant



Products made from 'Copper' or 'NL/DZR' material comply with NSF-61 & 372 and with the California No Lead Plumbing Law.

**CPVC Straight Adapter**

**F1807**

Item Number	Item Description	Pkg Type	Min Qty	Case Qty	Price
<b>CPVC SOCKET - COPPER</b>					
645XC2	1/2" F1807 × 1/2" CPVC	B	50	50	\$5.84
645XC23	1/2" F1807 × 3/4" CPVC	B	50	50	\$10.06
645XC2PK2	1/2" F1807 × 1/2" CPVC, 1/Bag	Cl	10	10	\$5.99
645XC3	3/4" F1807 × 3/4" CPVC	B	50	50	\$6.47
645XC34	3/4" F1807 × 1" CPVC	B	20	20	\$17.82
645XC3PK2	3/4" F1807 × 3/4" CPVC, 1/Bag	Cl	10	10	\$6.62
645XC4	1" F1807 × 1" CPVC	B	20	20	\$17.52
645XC43	1" F1807 × 3/4" CPVC	B	20	20	\$17.82
<b>CPVC SOCKET - NL/DZR BRASS</b>					
645XGC2	1/2" F1807 × 1/2" CPVC	B	50	50	\$17.36
645XGC3	3/4" F1807 × 3/4" CPVC	B	50	50	\$13.74
645XGC4	1" F1807 × 1" CPVC	X	20	20	\$25.39
<b>CPVC MALE - COPPER</b>					
645XCM2	1/2" F1807 × 1/2" Male CPVC	B	50	50	\$8.62



645XC3



645XGC3



645XCM2

**CPVC Straight Adapter**

**F1960**

Item Number	Item Description	Pkg Type	Min Qty	Case Qty	Price
<b>CPVC SOCKET - NL/DZR BRASS</b>					
645WGC2	1/2" F1960 × 1/2" CPVC	B	50	50	\$10.49
645WGC3	3/4" F1960 × 3/4" CPVC	B	50	50	\$17.93
645WGC4	1" F1960 × 1" CPVC	B	20	20	\$25.87
<b>CPVC SOCKET - COPPER &amp; NL/DZR BRASS</b>					
645WGC5	1-1/4" F1960 × 1-1/4" CPVC - Assembly	B	5	5	\$70.70
645WGC6	1-1/2" F1960 × 1-1/2" CPVC - Assembly	B	5	5	\$91.40
645WGC7	2" F1960 × 2" CPVC - Assembly	B	5	5	\$148.08



645WGC5

**CPVC Straight Adapter**

**F3347**

Item Number	Item Description	Pkg Type	Min Qty	Case Qty	Price
<b>CPVC SOCKET - COPPER &amp; NL/DZR BRASS</b>					
645VGC2	1/2" F3347 PEX Press × 1/2" CPVC	B	50	50	\$11.92
645VGC3	3/4" F3347 PEX Press × 3/4" CPVC	B	50	50	\$21.92
645VGC4	1" F3347 PEX Press × 1" CPVC	B	20	20	\$36.10



645VGC3

Supply

Drainage

Support

Specialties

Appendix



643-C418

### CPVC Straight Adapter

#### Male Sweat

- DO NOT cut this fitting. Cutting this fitting voids warranty
- Do not allow CPVC portion of fitting to be heated.

Item Number	Item Description	Pkg Type	Min Qty	Case Qty	Price
<b>CPVC SOCKET - COPPER</b>					
643-C211	1/2" CPVC × 1/2" MSWT, 11"	B	100	100	\$9.15
643-C311	3/4" CPVC × 3/4" MSWT, 11"	B	50	50	\$17.45
643-C418	1" CPVC × 1" MSWT, 18"	B	25	25	\$38.34
643-C518	1-1/4" CPVC × 1-1/4" MSWT, 18"	B	10	10	\$53.70
643-C620	1-1/2" CPVC × 1-1/2" MSWT, 20"	B	1	10	\$60.66
643-C722	2" CPVC × 2" MSWT, 22"	B	1	10	\$126.94

### CPVC Straight Adapter

#### MIP



646-CG2



646-CG5

Item Number	Item Description	Pkg Type	Min Qty	Case Qty	Price
<b>CPVC SOCKET - NL/DZR BRASS OVERMOLD</b>					
646-CG2	1/2" CPVC × 1/2" MIP	B	50	50	\$7.28
646-CG2PK1	1/2" CPVC × 1/2" MIP	BI	25	25	\$7.53
646-CG3	3/4" CPVC × 3/4" MIP	B	50	50	\$9.45
646-CG4	1" CPVC × 1" MIP	B	20	20	\$19.54
<b>CPVC SOCKET - NL/DZR BRASS</b>					
646-CG5	1-1/4" CPVC × 1-1/4" MIP	B	10	10	\$50.74
646-CG6	1-1/2" CPVC × 1-1/2" MIP	B	10	10	\$63.88
646-CG7	2" CPVC × 2" MIP	B	10	10	\$96.89

### CPVC Straight Adapter

#### FIP



647-CG2



647-CG6

Item Number	Item Description	Pkg Type	Min Qty	Case Qty	Price
<b>CPVC SOCKET - NL/DZR BRASS OVERMOLD</b>					
647-CG2	1/2" CPVC × 1/2" FIP	B	50	50	\$7.28
647-CG2PK1	1/2" CPVC × 1/2" FIP	CI	25	25	\$7.53
647-CG3	3/4" CPVC × 3/4" FIP	B	50	50	\$11.33
647-CG4	1" CPVC × 1" FIP	B	20	20	\$24.42
<b>CPVC SOCKET - NL/DZR BRASS</b>					
647-CG5	1-1/4" CPVC × 1-1/4" FIP	B	10	10	\$52.09
647-CG6	1-1/2" CPVC × 1-1/2" FIP	B	10	10	\$65.58
647-CG7	2" CPVC × 2" FIP	B	10	10	\$99.50



## CPVC Straight Adapter

### FIP Short-N-Swivel™

- DO NOT use pipe dope on FIP swivel threads



637-C20

Item Number	Item Description	Pkg Type	Min Qty	Case Qty	Price
<b>CPVC SOCKET - COPPER</b>					
633-C02	3/4" CPVC × 3/4" FIP Swivel	B	50	50	\$12.42
633-C02PK	3/4" CPVC × 3/4" FIP Swivel	Cl	10	10	\$12.92
633-C4403	1" CPVC × 1" FIP Swivel	B	20	20	\$24.98
637-C20	1/2" CPVC × 1/2" FIP Swivel	B	25	25	\$9.99
637-C20PK2	1/2" CPVC × 1/2" FIP Swivel	Cl	10	10	\$10.14

## CPVC Straight Adapter

### Press-Fitting

- Mechanical connection only
- Applying heat or cutting this fitting voids warranty.



685-C3

Item Number	Item Description	Pkg Type	Min Qty	Case Qty	Price
<b>CPVC SOCKET - COPPER</b>					
685-C2	1/2" CPVC × 1/2" Press-Fitting	B	20	20	\$7.13
685-C3	3/4" CPVC × 3/4" Press-Fitting	B	20	20	\$9.38
685-C4	1" CPVC × 1" Press-Fitting	B	20	20	\$13.55
685-C5	1-1/4" CPVC × 1-1/4" Press-Fitting	B	10	10	\$23.17
685-C6	1-1/2" CPVC × 1-1/2" Press-Fitting	B	5	5	\$33.11
685-C7	2" CPVC × 2" Press-Fitting	B	5	5	\$45.38

## CPVC Elbow Adapter

### Tub/Shower Elbow

#### Related Products

WiderSlider™ Adjustable Bracket p 533

Shower Arm Test Plug p 473

Item Number	Item Description	Pkg Type	Min Qty	Case Qty	Price
<b>DROP EAR - CPVC - NL/DZR</b>					
616-CG2E3	1/2" CPVC × 1/2" FIP	B	50	50	\$9.00
<b>DROP EAR - NL/DZR BRASS</b>					
647-CG2E3	1/2" CPVC × 1/2" FIP	B	50	50	\$12.99
647-CG2E3PK1	1/2" CPVC × 1/2" FIP, 1/Bag	Cl	10	10	\$13.24
<b>EARED ELBOW - LEADED</b>					
647-C3E	3/4" CPVC × 3/4" FIP	B	25	25	\$22.21
647-C4E	1" CPVC × 1" FIP	B	10	10	\$35.72



616-CG2E3



647-CG2E3

Supply

Drainage

Support

Specialties

Appendix



615-C215

## Wal-Let™ - CPVC

### Wall Termination Fitting

Item Number	Item Description	Pkg Type	Min Qty	Case Qty	Price
<b>LEADED</b>					
615-C2113	1/2" FIP × 1/2" CPVC, 11" Straight	B	25	25	\$31.90
615-C215	1/2" FIP × 1/2" CPVC, 1-5/8" Straight	B	10	10	\$23.01

**CPVC Stub Out Elbow**

**Standard**

- Do not allow CPVC portion of fitting to be heated.

Item Number	Item Description	Pkg Type	Min Qty	Case Qty	Price
630-C2412	1/2" CPVC, 4" x 12"	B	50	50	\$12.27
630-C248	1/2" CPVC, 4" x 8"	B	50	50	\$8.26
630-C248PK	1/2" CPVC, 4" x 8"	Cl	10	10	\$8.76
630-C287	1/2" CPVC, 8" x 7"	B	50	50	\$12.27
630-C348	3/4" CPVC, 6" x 8"	B	50	50	\$17.75
630-C3612	3/4" CPVC, 6" x 12"	B	25	25	\$27.60
630-C41016	1" CPVC, 10" x 16"	B	25	25	\$50.25
630-C41110	1" CPVC, 11" x 10"	B	25	25	\$42.76



630-C248

**CPVC Stub Out Elbow**

**Square O Strap**

- Do not allow CPVC portion of fitting to be heated.

Item Number	Item Description	Pkg Type	Min Qty	Case Qty	Price
630-C248E	1/2" CPVC, 4" x 8", w/Strap	B	25	25	\$9.26
630-C41110E	1" CPVC, 11" x 10", w/ Strap	B	10	10	\$44.10



630-C248E

**CPVC Tub/Shower Pressure Connector**

- DO NOT use pipe dope on FIP swivel threads
- Do not allow CPVC portion of fitting to be heated

Item Number	Item Description	Pkg Type	Min Qty	Case Qty	Price
632-C263	1/2" CPVC x 1/2" MSWT, 6" x 2-1/4"	B	50	50	\$6.36
632-C263PK	1/2" CPVC x 1/2" MSWT, 6" x 2-1/4"	Cl	10	10	\$6.86
632-C263X	1/2" CPVC x 1/2" MIP Swivel, 6" x 3"	B	50	50	\$13.12
632-C263XPK	1/2" CPVC x 1/2" MIP Swivel, 6" x 3"	Cl	10	10	\$13.62
632-C263YPK	1/2" CPVC x 1/2" FIP Swivel, 6" x 3"	Cl	10	10	\$13.11
632-C283	1/2" CPVC x 1/2" MSWT, 8" x 3"	B	50	50	\$7.38



632-C263X

Supply

Drainage

Support

Specialties

Appendix



631-C307



631-CG307FP



633-C09



633-CG24FP



633-CG18HRV

## CPVC Water Heater Connector

### FIP Swivel Elbow

· DO NOT use pipe dope on FIP swivel threads

Item Number	Item Description	Pkg Type	Min Qty	Case Qty	Price
<b>STANDARD</b>					
631-C307	3/4" CPVC × 3/4" FIP Swivel, 7" × 3"	B	25	25	\$23.10
<b>VALVED, FULL PORT</b>					
631-CG307FP	3/4" CPVC × 3/4" FIP Swivel, 7" × 3"	B	10	10	\$56.18

## CPVC Water Heater Connector

### FIP Swivel Straight

· DO NOT use pipe dope on FIP swivel threads

Item Number	Item Description	Pkg Type	Min Qty	Case Qty	Price
<b>STANDARD</b>					
633-C02	3/4" CPVC × 3/4" FIP Swivel	B	50	50	\$12.42
633-C02PK	3/4" CPVC × 3/4" FIP Swivel	CI	10	10	\$12.92
633-C09	3/4" CPVC × 3/4" FIP Swivel, 9"	B	25	25	\$19.14
633-C18	3/4" CPVC × 3/4" FIP Swivel, 18"	B	25	25	\$27.78
633-C24	3/4" CPVC × 3/4" FIP Swivel, 24"	B	25	25	\$33.54
633-C418	3/4" CPVC × 1" FIP Swivel, 18"	B	25	25	\$38.78
<b>VALVED, FULL PORT</b>					
633-CG18FP	3/4" CPVC × 3/4" FIP Swivel, 18"	B	10	10	\$62.78
633-CG18FPT	3/4" CPVC × 3/4" FIP Swivel, w/ 3/4" FIP Branch	B	10	10	\$76.78
633-CG418FP	3/4" CPVC × 1" FIP Swivel, 18"	B	10	10	\$73.78
<b>THERMAL EXPANSION VALVE, FULL PORT</b>					
633-CG18FRV	3/4" CPVC × 3/4" FIP Swivel, w/ Pressure Relief 3/8" Comp., 18"	B	10	10	\$72.78
633-CG18HRV	3/4" CPVC × 3/4" FIP Swivel, w/ Pressure Relief 3/8" Hose Barb, 18"	B	10	10	\$72.78

## CPVC Water Heater Connector

### Flexible Copper FIP Swivel

· DO NOT use pipe dope on FIP swivel threads  
 · Do not twist or kink flexible connector

Item Number	Item Description	Pkg Type	Min Qty	Case Qty	Price
<b>STANDARD</b>					
634-C118	3/4" CPVC × 3/4" FIP Swivel, 18"	B	25	25	\$24.69

## CPVC Water Heater Connector (Cont)

### Flexible Copper FIP Swivel

Item Number	Item Description	Pkg Type	Min Qty	Case Qty	Price
<b>VALVED, FULL PORT</b>					
634-CG118FP	3/4" CPVC x 3/4" FIP Swivel, 18"	B	25	25	\$58.39



634-CG118FP

## CPVC Water Heater Connector

### MIP Straight

Item Number	Item Description	Pkg Type	Min Qty	Case Qty	Price
<b>STANDARD</b>					
646-CG318	3/4" CPVC x 3/4" MIP, 18"	B	25	25	\$25.88
<b>VALVED, FULL PORT</b>					
646-CG318FP	3/4" CPVC x 3/4" MIP, 18"	B	10	10	\$69.60



646-CG318FP

## CPVC Water Heater Connector

### T&P Relief Adapter

Item Number	Item Description	Pkg Type	Min Qty	Case Qty	Price
646-C4308	1" CPVC x 3/4" MIP, 8"	B	25	25	\$23.92



646-C4308

## CPVC Brass Ball Valve

Item Number	Item Description	Pkg Type	Min Qty	Case Qty	Price
<b>FULL PORT</b>					
648-CG2FP	1/2" CPVC	B	10	10	\$32.82
648-CG3FP	3/4" CPVC	B	10	10	\$48.76
648-CG4FP	1" CPVC	B	10	10	\$93.97
648-CG5FP	1-1/4" CPVC	B	5	5	\$144.79
648-CG6FP	1-1/2" CPVC	B	1	1	\$201.65
648-CG7FP	2" CPVC	B	1	1	\$314.55
<b>FULL PORT WITH DRAIN</b>					
648-CG2FPD	1/2" CPVC	B	10	10	\$39.83
648-CG3FPD	3/4" CPVC	B	10	10	\$56.53
648-CG4FPD	1" CPVC	B	10	10	\$102.51



648-CG2FP



648-CG2FPD

Supply

Drainage

Support

Specialties

Appendix



117-C22



118-C208



119-C208

### CPVC Sillcock

Item Number	Item Description	Pkg Type	Min Qty	Case Qty	Price
<b>LEADED</b>					
117-C22	1/2" CPVC x 3/4" MHT	B	25	25	\$22.98
117-C223E	1/2" CPVC x 3/4" MHT	B	25	25	\$25.14

### CPVC Frost-Proof Anti-Siphon Sillcock

**Related Products**

Frost-Proof Sillcock Replacement Parts p 114

Item Number	Item Description	Pkg Type	Min Qty	Case Qty	Price
<b>MULTI-TURN - LEADED</b>					
118-C208	1/2" CPVC, 8"	B	5	5	\$44.58
<b>1/4 TURN - LEADED</b>					
119-C208	1/2" CPVC, 8"	B	5	5	\$71.51
119-C210	1/2" CPVC, 10"	B	5	5	\$75.32

## CPVC Stub Out Elbow Kit

### 1/2" Water Closet Stub Out With Bracket

- Do not allow CPVC portion of fitting to be heated
- For individual product details, see product pages



Item Number	Item Description	Pkg Type	Min Qty	Case Qty	Price
<b>16" STUD BAYS</b>					
689C0101	(1) 525-1612, (1) 630-C248	BI	12	12	\$13.72
<b>24" STUD BAYS</b>					
689C0111	(1) 525-2412, (1) 630-C248	BI	12	12	\$14.47

## CPVC Stub Out Elbow Kit

### 1/2" Lav/Sink Stub Outs With Bracket

- Do not allow CPVC portion of fitting to be heated
- For individual product details, see product pages



Item Number	Item Description	Pkg Type	Min Qty	Case Qty	Price
<b>16" STUD BAYS</b>					
689C1102	(1) 525-1622, (2) 630-C248	BI	12	12	\$23.32
<b>24" STUD BAYS</b>					
689C1112	(1) 522-2422, (2) 630-C248	BI	12	12	\$24.06

## CPVC Water Heater Connector Kit

- DO NOT use pipe dope on FIP swivel threads
- Do not allow CPVC portion of fitting to be heated
- For individual product details, see product pages



Item Number	Item Description	Pkg Type	Min Qty	Case Qty	Price
694CG33012091	(1) 631-CG1307FP, (1) 633-C18, (1) 633-G3TM15	BI	10	10	\$125.36
694CG33012093	(1) 631-CG1307FP, (1) 633-C18, (1) 633-G3TM11	BI	10	10	\$121.52
694CG331220	(1) 633-C18, (1) 633-CG18FP	BI	10	10	\$92.56
694CG36012092	(1) 631-CG1307FP, (1) 633-C418, (1) 633-G4TM15	BI	10	10	\$147.36





# ASTM F438 CPVC Systems

## IPS F438 CPVC - Fittings, Adapters & Connectors

Sioux Chief offers iron pipe size (IPS) CPVC transition fittings, which are compatible with FlowGuard Gold® pipe/fittings and are FGG/BM/CZ™ system compatible. The CPVC sockets are GRAY in color, and are made to the ASTM F438 standard.

All fittings are 100% production tested to ensure maximum quality and a leak-free connection.

**Important Notes About Sioux Chief CPVC Fittings:**

Do not cut, or modify any Sioux Chief CPVC transition fitting (except 630-C series fittings). Do not expose CPVC transition area of fitting to heat in excess of 180°F. Never install a damaged fitting.

See complete installation instructions at  
[www.siouxchief.com](http://www.siouxchief.com)



FBC™ System Compatible indicates that this product has been tested, and is monitored on an ongoing basis, to assure its chemical compatibility with FlowGuard Gold®, BlazeMaster® and Corzan® piping systems and products made with TempRite® Technology. The FBC System Compatible Logo, FBC™, FlowGuard Gold®, BlazeMaster®, Corzan®, and TempRite® are trademarks of Lubrizol Advanced Materials, Inc. or its affiliates.



---

### Male Sweat Fittings

**PRESS-FIT  
COMPATIBLE** All Sioux Chief male sweat, preformed copper fittings are compatible with press-fit systems and all push fit systems. Do not use push fittings with nickel-plated stub outs.

### Lead-Free Compliant

**LEAD  
FREE  
COMPLIANT**

Products made from 'Copper' or 'NL/DZR' material comply with NSF-61 & 372 and with the California No Lead Plumbing Law.

**CPVC Straight Adapter - IPS Gray**

**F1807**

Item Number	Item Description	Pkg Type	Min Qty	Case Qty	Price
<b>COPPER PVC CUP</b>					
645XC923	1/2" F1807 × 3/4" Sch 40 CPVC	B	25	25	\$12.47
645XC93	3/4" F1807 × 3/4" Sch 40 CPVC	B	50	50	\$12.15
645XC94	1" F1807 × 1" Sch 40 CPVC	B	20	20	\$24.41



645XC93

**CPVC Straight Adapter - IPS Gray**

**F1960**

Item Number	Item Description	Pkg Type	Min Qty	Case Qty	Price
<b>NL/DZR PVC CUP</b>					
645WGC93	3/4" F1960 × 3/4" Sch 40 CPVC	B	50	50	\$18.14
645WGC94	1" F1960 × 1" Sch 40 CPVC	B	20	20	\$29.38
645WGC95	1-1/4" F1960 × 1-1/4" Sch 40 CPVC	B	10	10	\$73.29



645WGC93

**CPVC Straight Adapter - IPS Gray**

**Male Sweat**

- Do not cut this fitting. Cutting this fitting voids warranty
- Do not allow CPVC portion of fitting to be heated.

Item Number	Item Description	Pkg Type	Min Qty	Case Qty	Price
<b>COPPER PVC CUP</b>					
643-C9211	1/2" Sch 40 CPVC, 11"	B	25	25	\$11.87
643-C9311	3/4" Sch 40 CPVC, 11"	B	25	25	\$21.41
643-C9418	1" Sch 40 CPVC, 18"	B	25	25	\$40.95



643-C9418

**CPVC Straight Adapter - IPS Gray**

**MIP**

Item Number	Item Description	Pkg Type	Min Qty	Case Qty	Price
<b>NL/DZR BRASS PVC CUP</b>					
646-CG92	1/2" Sch 40 CPVC × 1/2" MIP	B	50	50	\$6.87
646-CG93	3/4" Sch 40 CPVC × 3/4" MIP	B	50	50	\$9.45
646-CG94	1" Sch 40 CPVC × 1" MIP	B	20	20	\$28.45
646-CG95	1-1/4" Sch 40 CPVC × 1-1/4" MIP	B	10	10	\$50.74
646-CG96	1-1/2" Sch 40 CPVC × 1-1/2" MIP	B	10	10	\$63.88
646-CG97	2" Sch 40 CPVC × 2" MIP	B	10	10	\$96.89



646-CG96

Supply

Drainage

Support

Specialties

Appendix



647-CG97

### CPVC Straight Adapter - IPS Gray

#### FIP

Item Number	Item Description	Pkg Type	Min Qty	Case Qty	Price
<b>NL/DZR BRASS PVC CUP</b>					
647-CG92	1/2" Sch 40 CPVC x 1/2" FIP	B	50	50	\$6.87
647-CG93	3/4" Sch 40 CPVC x 3/4" FIP	B	50	50	\$10.67
647-CG94	1" Sch 40 CPVC x 1" FIP	B	20	20	\$28.45
647-CG95	1-1/4" Sch 40 CPVC x 1-1/4" FIP	B	10	10	\$52.09
647-CG96	1-1/2" Sch 40 CPVC x 1-1/2" FIP	B	10	10	\$65.58
647-CG97	2" Sch 40 CPVC x 2" FIP	B	10	10	\$99.50



630-C93612

### CPVC Stub Out Elbow - IPS Gray

· Do not allow CPVC portion of fitting to be heated.

Item Number	Item Description	Pkg Type	Min Qty	Case Qty	Price
630-C9248	1/2" Sch 40 CPVC, 4" x 8"	B	50	50	\$10.91
630-C93612	3/4" Sch 40 CPVC, 6" x 12"	B	25	25	\$32.39
630-C941012	1" Sch 40 CPVC, 10" x 12"	B	25	25	\$58.07

# PVC Systems

## PVC Fittings & Valves

Sioux Chief offers the most complete line of Sch. 40 PVC transition fittings for potable water or irrigation systems in the industry.

Sioux Chief PVC fittings conform to ASTM F1970 standard for use in PVC piping systems and are designed for use with Sch. 40 PVC pipe conforming to ASTM D1785.

**Important Notes About Sioux Chief PVC Fittings:**

Do not expose PVC transition area of fitting to heat in excess of 140°F.

PVC fittings are intended for use in cold water applications only.

Do not cut, or modify any Sioux Chief PVC transition fitting.

Never install a damaged fitting.



See complete installation instructions at [www.siouxchief.com](http://www.siouxchief.com)



---

### Male Sweat Fittings

**PRESS-FIT  
COMPATIBLE** All Sioux Chief male sweat, preformed copper fittings are compatible with press-fit systems and all push fit systems. Do not use push fittings with nickel-plated stub outs.

### Lead-Free Compliant

**LEAD  
FREE  
COMPLIANT** Products made from 'Copper' or 'NL/DZR' material comply with NSF-61 & 372 and with the California No Lead Plumbing Law.

## PVC Straight Adapter

### F1807

Item Number	Item Description	Pkg Type	Min Qty	Case Qty	Price
<b>COPPER PVC CUP</b>					
645X23P	1/2" F1807 × 3/4" PVC	B	50	50	\$12.53
645X34P	3/4" F1807 × 1" PVC	B	20	20	\$18.73
645X3P	3/4" F1807 × 3/4" PVC	B	50	50	\$11.89
645X43P	1" F1807 × 3/4" PVC	B	20	20	\$18.86
645X4P	1" F1807 × 1" PVC	B	20	20	\$19.64



645X3P

## PVC Straight Adapter

### F1960

Item Number	Item Description	Pkg Type	Min Qty	Case Qty	Price
<b>NL/DZR PVC CUP</b>					
645WG3P	3/4" F1960 × 3/4" PVC	B	50	50	\$15.97
645WG4P	1" F1960 × 1" PVC	B	20	20	\$29.38



645WG3P

## PVC Straight Adapter

### Male Sweat

- DO NOT cut this fitting. Cutting this fitting voids warranty
- Do not allow PVC portion of fitting to be heated.

Item Number	Item Description	Pkg Type	Min Qty	Case Qty	Price
<b>COPPER PVC CUP</b>					
643-P311	3/4" PVC × 3/4" MSWT, 11"	B	50	50	\$22.07
643-P418	1" PVC × 1" MSWT, 18"	B	25	25	\$42.98
643-P518	1-1/4" PVC × 1-1/4" MSWT, 18"	B	1	10	\$58.31
643-P620	1-1/2" PVC × 1-1/2" MSWT, 20"	B	1	10	\$69.92
643-P722	2" PVC × 2" MSWT, 22"	B	1	10	\$136.19



643-P418

Supply

Drainage

Support

Specialties

Appendix



646-PG3



646-PG5



647-PG3



647-PG5



685-P3

### PVC Straight Adapter

#### MIP

Item Number	Item Description	Pkg Type	Min Qty	Case Qty	Price
<b>NL/DZR COPPER ASSEMBLY</b>					
646-PG3	3/4" PVC × 3/4" MIP	B	50	50	\$14.37
<b>NL/DZR BRASS ROLL OVER</b>					
646-PG4	1" PVC × 1" MIP	B	20	20	\$22.62
646-PG5	1-1/4" PVC × 1-1/4" MIP	B	10	10	\$32.20
646-PG6	1-1/2" PVC × 1-1/2" MIP	B	10	10	\$67.39
646-PG7	2" PVC × 2" MIP	B	10	10	\$91.33

### PVC Straight Adapter

#### FIP

Item Number	Item Description	Pkg Type	Min Qty	Case Qty	Price
<b>NL/DZR COPPER ASSEMBLY</b>					
647-PG3	3/4" PVC × 3/4" FIP	B	50	50	\$17.09
<b>NL/DZR BRASS ROLL OVER</b>					
647-PG4	1" PVC × 1" FIP	B	20	20	\$26.25
647-PG5	1-1/4" PVC × 1-1/4" FIP	B	10	10	\$58.87
647-PG6	1-1/2" PVC × 1-1/2" FIP	B	10	10	\$79.13
647-PG7	2" PVC × 2" FIP	B	10	10	\$119.81

### PVC Straight Adapter

#### Press-Fitting and Push Fit Compatible

- Mechanical connection only
- Applying heat or cutting this fitting voids warranty

Item Number	Item Description	Pkg Type	Min Qty	Case Qty	Price
<b>COPPER PVC CUP</b>					
685-P3	3/4" PVC × 3/4" Press-Fit	B	20	20	\$10.65
685-P4	1" PVC × 1" Press-Fit	B	20	20	\$14.83
685-P5	1-1/4" PVC × 1-1/4" Press-Fit	B	10	10	\$24.46
685-P6	1-1/2" PVC × 1-1/2" Press-Fit	B	5	5	\$34.39
685-P7	2" PVC × 2" Press-Fit	B	5	5	\$46.65



**PVC Brass Ball Valve**

Item Number	Item Description	Pkg Type	Min Qty	Case Qty	Price
<b>FULL PORT</b>					
648-PG3FP	3/4" PVC	B	10	10	\$57.26
648-PG4FP	1" PVC	B	10	10	\$101.74
648-PG5FP	1-1/4" PVC	B	5	5	\$151.98
648-PG6FP	1-1/2" PVC	B	1	1	\$179.50
648-PG7FP	2" PVC	B	1	1	\$325.40

- Supply
- Drainage
- Support
- Specialties
- Appendix



# Sweat Systems

**Sweat Fittings, Adapters & Valves**

**Sweat Manifolds**



Spun-closed ends eliminate the need to solder on caps, while stub out elbows use a longer bend radius than standard fittings to decrease turbulent flow, reducing water line noise, potential leak points, water stacking in showers, and can provide better flow to fixtures.

All copper tube used in Sioux Chief preformed copper assemblies is domestically made and is fabricated/assembled in Missouri. The copper tube is made to ASTM B88 and fitting ends are made to ANSI B16.22



**614-2**  
Page 101



**616-2E3**  
Page 101



**609-L2138**  
Page 103



**609-L246E**  
Page 103



**613-57M**  
Page 105



**622-L08**  
Page 106



**609-L263A**  
Page



**616-648**  
Page 107



**631-G305FP**  
Page 107



**633-318**  
Page 108



**634-115**  
Page 109



**633-G3TM15**  
Page 109



**633-G3TM18FP**  
Page 109



**636-L3888**  
Page



**601-G20CV**  
Page 111



**646-GP4312FD**  
Page 111



**104-G23**  
Page



**117-12**  
Page 113



**118M208**  
Page 113



**117-03**  
Page 114



**678-20344**  
Page 116



**67745L-08334**  
Page 117



**675-V20244**  
Page 118



**693-13155301**  
Page 119

## Male Sweat Fittings

### PRESS-FIT

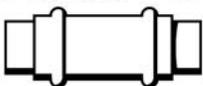

### COMPATIBLE

All Sioux Chief male sweat, preformed copper fittings are compatible with press-fit systems and all push fit systems. Do not use push fittings with nickel-plated stub outs.

## Lead-Free Compliant



Products made from 'Copper' or 'NL/DZR' material comply with NSF-61 & 372 and with the California No Lead Plumbing Law.

**Full Slip Male Adapter**

**Brass Female Sweat × MIP**

Item Number	Item Description	Pkg Type	Min Qty	Case Qty	Price
<b>LEADED</b>					
614-2	1/2" FSWT × 1/2" MIP Thread	B	50	500	\$2.55
614-3	3/4" FSWT × 3/4" MIP Thread	B	50	500	\$3.67
614-4	1" FSWT × 1" MIP Thread	B	25	250	\$7.85



614-2

**Wal-Let™**

**Wall Termination Fitting**

Item Number	Item Description	Pkg Type	Min Qty	Case Qty	Price
<b>LEADED</b>					
615-213	1/2" FIP × 1/2" FSWT	B	10	10	\$15.58
615-233	1/2" FIP × 1/2" FIP	B	10	10	\$18.56
615-313	3/4" FIP × 3/4" FSWT	B	10	10	\$31.90
615-333	3/4" FIP × 3/4" FIP	B	10	10	\$31.90
615-C2113	1/2" FIP × 1/2" CPVC, 11" Straight	B	25	25	\$31.90
615-C215	1/2" FIP × 1/2" CPVC, 1-5/8" Straight	B	10	10	\$23.01
615W216	1/2" FIP × 1/2" F1960	B	25	25	\$27.16



615-213

**Sweat Elbow Adapter**

**Tub Shower Elbow**

**Related Products**

Shower Arm Test Plug p 473

WiderSlider™ Adjustable Bracket p 533

Item Number	Item Description	Pkg Type	Min Qty	Case Qty	Price
<b>DROP-EAR - LEADED</b>					
616-2E3	1/2" FIP × 1/2" FSWT	B	50	50	\$8.95
616-3E3	3/4" FIP × 3/4" FSWT	B	25	25	\$11.78
<b>SHOWER-LOCK - LEADED</b>					
616-2	1/2" FSWT × 1/2" FIP	B	50	50	\$14.99
616-2PK2	1/2" FSWT × 1/2" FIP, 1/Bag	Cl	10	10	\$15.49



616-2E3



616-2

Supply

Drainage

Support

Specialties

Appendix



637-G23H

### Elbow Adapter

#### Dishwasher Elbow

· DO NOT use pipe dope on threads

Item Number	Item Description	Pkg Type	Min Qty	Case Qty	Price
<b>NL/DZR BRASS</b>					
637-G23H	3/4" Female Hose Thread × 3/8" OD Comp., Short Radius, Heavy-Duty Hose Nut, Rough Brass, 1/Bag	B	20	20	\$7.49



929-01302001

### Sweat Dielectric Union

Item Number	Item Description	Pkg Type	Min Qty	Case Qty	Price
929-01302001	3/4" FIP × 1/2" SWT	BI	5	20	\$16.96
929-01303001	3/4" FIP × 3/4" SWT	BI	5	60	\$16.69

Termination Fitting

FIP

Item Number	Item Description	Pkg Type	Min Qty	Case Qty	Price
<b>MALE SWEAT</b>					
622-L09CF	1/2" FIP x 1/2" MSWT, 1/2" CTS, 9"	B	25	25	\$16.09



Sweat Coupling

Full Slip Repair Coupling

Item Number	Item Description	Pkg Type	Min Qty	Case Qty	Price
<b>FEMALE SWEAT</b>					
600-206PK	1/2" CTS, 6"	Cl	10	10	\$5.06
600-212PK	1/2" CTS, 12"	Cl	10	10	\$9.00
600-306PK	3/4" CTS, 6"	Cl	10	10	\$6.90
600-312PK	3/4" CTS, 12"	Cl	10	10	\$13.01



Sweat Stub Out Elbow

Item Number	Item Description	Pkg Type	Min Qty	Case Qty	Price
<b>MALE SWEAT</b>					
608-L2138	1/2" CTS, 13" x 8"	B	50	50	\$12.79
608-L2187	1/2" CTS, 18" x 7"	B	50	50	\$15.68
608-L2277	1/2" CTS, 27" x 7"	B	50	50	\$22.41
608-L246	1/2" CTS, 3-1/2" x 6"	B	50	50	\$5.75
608-L248	1/2" CTS, 3-1/2" x 8"	B	50	50	\$6.74
608-L2812	1/2" CTS, 8" x 12"	B	50	50	\$12.27
608-L348	3/4" CTS, 4" x 8"	B	50	50	\$13.34
608-L4612	1" CTS, 6" x 12"	B	25	25	\$32.54
<b>FEMALE SWEAT</b>					
609-L2138	1/2" CTS, 13" x 8"	B	50	50	\$13.12
609-L246	1/2" CTS, 3-1/2" x 6"	B	50	50	\$6.08
609-L248	1/2" CTS, 3-1/2" x 8"	B	50	50	\$7.09
609-L2612	1/2" CTS, 6" x 12"	B	50	50	\$12.61
609-L2812	1/2" CTS, 8" x 12"	B	50	50	\$12.61
609-L348	3/4" CTS, 4" x 8"	B	50	50	\$13.66
609-L4612	1" CTS, 6" x 12"	B	25	25	\$32.86
609-L4812	1" CTS, 8" x 12"	B	25	25	\$36.64



Sweat Stub Out Elbow

Square O Strap

Item Number	Item Description	Pkg Type	Min Qty	Case Qty	Price
<b>FEMALE SWEAT</b>					
609-L246E	1/2" CTS, 3-1/2" x 6", w/ Strap	B	25	25	\$7.07
609-L248E	1/2" CTS, 3-1/2" x 8", w/ Strap	B	25	25	\$8.08



Supply

Drainage

Support

Specialties

Appendix

Supply

Drainage

Support

Specialties

Appendix



608-D288E

### Sweat Stub Out Elbow

#### Double Stub Out

**Related Products**

3-Valve Kitchen Supply Box p 179

Item Number	Item Description	Pkg Type	Min Qty	Case Qty	Price
<b>MALE SWEAT</b>					
608-D288E	1/2" CTS, Type L, 7" x 8" x 8" w/ Strap	B	25	25	\$22.49



613-887L

### Sweat Stub Out Elbow

#### Male Sweat Offset

Item Number	Item Description	Pkg Type	Min Qty	Case Qty	Price
613-887L	1/2" CTS, Left, Type L	B	25	25	\$15.72
613-887R	1/2" CTS, Right, Type L	B	25	25	\$15.72



## Sweat Tub Spout Elbow

· DO NOT use pipe dope on FIP swivel threads

### Related Products

SmartSpout™ Tub Spout p 639

Item Number	Item Description	Pkg Type	Min Qty	Case Qty	Price
<b>MALE SWEAT</b>					
613-107	1/2" CTS, 10" × 7", Type L	B	50	50	\$10.28
613-137	1/2" CTS, 13" × 7", Type L	B	50	50	\$12.37
613-139	1/2" CTS, 13" × 9", Type L	B	50	50	\$13.84
613-57	1/2" CTS, 5" × 7", Type L	B	50	50	\$7.20
613-57PK	1/2" CTS, 5" × 7", Type L	Cl	20	20	\$7.70
613-67	1/2" CTS, 6" × 7", Type L	B	50	50	\$7.76
613-87	1/2" CTS, 8" × 7", Type L	B	50	50	\$8.57
<b>MALE SWEAT WITH SQUARE O STRAP</b>					
613-87E	1/2" CTS, 8" × 7", Type L	B	25	25	\$9.58
<b>MALE SWEAT WITH WALL BLOCK</b>					
612-108	1/2" CTS, 10" × 8", Type L	B	25	25	\$12.67
612-57	1/2" CTS, 5" × 7", Type L	B	25	25	\$8.52
612-87	1/2" CTS, 8" × 7", Type L	B	25	25	\$9.90
<b>MIP SWIVEL</b>					
613-57X	1/2" CTS, 5" × 7", Type L	B	50	50	\$14.16
613-67X	1/2" CTS, 6" × 7", Type L	B	50	50	\$14.72
613-87X	1/2" CTS, 8" × 7", Type L	B	50	50	\$15.56
<b>MIP</b>					
613-57M	1/2" CTS, 5-1/2" × 7", Type L	B	50	50	\$11.12
613-67M	1/2" CTS, 6-1/2" × 7", Type L	B	50	50	\$11.67
613-87M	1/2" CTS, 8-1/2" × 7", Type L	B	50	50	\$12.53
<b>MIP WITH WALL BLOCK</b>					
612-557	1/2" CTS, 5-1/2" × 7", Type L	B	25	25	\$12.49
<b>FIP SWIVEL</b>					
613-57Y	1/2" CTS, 5" × 7", Type L	B	50	50	\$13.47
613-67Y	1/2" CTS, 6" × 7", Type L	B	50	50	\$14.03
613-87Y	1/2" CTS, 8" × 7", Type L	B	50	50	\$14.90
<b>FIP</b>					
613-67F	1/2" CTS, 6" × 7", Type L	B	50	50	\$11.74



613-139



613-87E



612-57



613-57X



613-57Y

Supply

Drainage

Support

Specialties

Appendix



622-L06



622-L24E

## Sweat Bullet™

### Male Sweat

· Not to be used as permanent air chambers

Item Number	Item Description	Pkg Type	Min Qty	Case Qty	Price
<b>SPUN CLOSED</b>					
622-L03	1/2" CTS, 3", Type L	B	100	100	\$2.38
622-L06	1/2" CTS, 6", Type L	B	100	100	\$3.58
622-L06PK	1/2" CTS, 6", Type L	CI	20	20	\$4.08
622-L08	1/2" CTS, 8", Type L	B	100	100	\$4.57
622-L08PK	1/2" CTS, 8", Type L	CI	10	10	\$5.07
622-L10	1/2" CTS, 10", Type L	B	100	100	\$5.80
622-L12	1/2" CTS, 12", Type L	B	100	100	\$6.89
622-L12PK	1/2" CTS, 12", Type L	BI	10	10	\$7.39
622-L15	1/2" CTS, 15", Type L	B	100	100	\$8.49
623-L06	3/4" CTS, 6", Type L	B	50	50	\$7.34
623-L08	3/4" CTS, 8", Type L	B	50	50	\$9.39
623-L12	3/4" CTS, 12", Type L	B	50	50	\$14.10
623-L18	3/4" CTS, 18", Type L	B	50	50	\$20.57
624-L08	1" CTS, 8", Type L	B	30	30	\$14.82
624-L12	1" CTS, 12" Type L	B	30	30	\$19.59
624-L15	1" CTS, 15", Type L	B	30	30	\$24.24
624-L18	1" CTS, 18", Type L	B	30	30	\$27.47
<b>SPUN CLOSED WITH STRAP</b>					
622-L24E	1/2" CTS, 24" Long, 12" Stub Out, Type L	B	20	20	\$15.16

## Sweat Bullet™

### MIP

· Not to be used as permanent air chambers



614-8L

Item Number	Item Description	Pkg Type	Min Qty	Case Qty	Price
614-8L	1/2" CTS, 8-1/2", Type L	B	50	50	\$8.53

## Sweat Tub/Shower Pressure Connector



609-L263A

Item Number	Item Description	Pkg Type	Min Qty	Case Qty	Price
608-L263A	1/2" MSWT x 1/2" MSWT, 2-1/4" x 6"	B	50	50	\$5.81

Riser Stub Out

· DO NOT use pipe dope on FIP swivel threads

Related Products

Shower WallNut™ p 640

Item Number	Item Description	Pkg Type	Min Qty	Case Qty	Price
<b>MALE SWEAT</b>					
608-L2308	1/2" MSWT × Spun, 30" × 8"	B	25	25	\$25.36
608-L2508	1/2" MSWT × Spun, 50" × 8"	B	25	25	\$36.89
616-630	1/2" MSWT × 1/2" FIP Drop-Ear, 30"	B	50	50	\$27.79
616-648	1/2" MSWT × 1/2" FIP Drop-Ear, 48"	B	12	12	\$33.16
616-650	1/2" MSWT × 1/2" FIP Drop-Ear, 50"	B	25	25	\$40.71
<b>MALE SWEAT WITH SQAURE O STRAP</b>					
608-L2508E	1/2" MSWT × Spun, 50" × 8", w/ Strap	B	25	25	\$37.87
<b>MIP SWIVEL</b>					
616-630X	1/2" MIP Swivel × 1/2" FIP Drop-Ear, 30"	B	50	50	\$34.58
616-650X	1/2" MIP Swivel × 1/2" FIP Drop-Ear, 50"	B	25	25	\$47.53
<b>FIP SWIVEL</b>					
616-630Y	1/2" FIP Swivel × 1/2" FIP Drop-Ear, 30"	B	50	50	\$33.92
616-650Y	1/2" FIP Swivel × 1/2" FIP Drop-Ear, 50"	B	25	25	\$46.82



Riser Stub Out

Offset

Item Number	Item Description	Pkg Type	Min Qty	Case Qty	Price
<b>MALE SWEAT</b>					
616-15	1/2" MSWT × 1/2" FSWT, 1-1/2" Offset	B	25	25	\$5.57



Water Heater Connector

Female Sweat × FIP Elbow

· DO NOT use pipe dope on FIP swivel threads

Item Number	Item Description	Pkg Type	Min Qty	Case Qty	Price
<b>STANDARD</b>					
631-33F	3/4" FIP Swivel × 3/4" FSWT, 3" × 3"	B	25	25	\$14.76
<b>VALVED, FULL PORT</b>					
631-G305FP	3/4" FIP Swivel × 3/4" FSWT, 3" × 5"	B	25	25	\$49.76



Supply

Drainage

Support

Specialties

Appendix



631-33

### Water Heater Connector

#### FIP Swivel Elbow

· DO NOT use pipe dope on FIP swivel threads

Item Number	Item Description	Pkg Type	Min Qty	Case Qty	Price
631-33	3/4" FIP Swivel × 3/4" FIP Swivel, 3" × 3"	B	1	25	\$16.76



633-318

### Water Heater Connector

#### FIP Swivel × Male Sweat

· DO NOT use pipe dope on FIP swivel threads

Item Number	Item Description	Pkg Type	Min Qty	Case Qty	Price
<b>STANDARD</b>					
633-318	3/4" FIP Swivel × 3/4" MSWT, 18"	B	10	10	\$21.78
<b>VALVED, FULL PORT</b>					
633-G318FP	3/4" FIP Swivel × 3/4" MSWT, 18"	B	10	10	\$58.28



633-G318FP

### Water Heater Connector

#### FIP Swivel × Full-Slip Female Sweat

· DO NOT use pipe dope on FIP swivel threads

Item Number	Item Description	Pkg Type	Min Qty	Case Qty	Price
<b>STANDARD</b>					
633-312	3/4" FIP Swivel × 3/4" Full-Slip FSWT	B	25	25	\$17.67
<b>VALVED, FULL PORT</b>					
633-G312FP	3/4" FIP Swivel × 3/4" Full-Slip FSWT	B	10	10	\$52.67



633-4312



633-G312FP

## Water Heater Connector

### Flexible Copper Water Heater Connector

- DO NOT use pipe dope on FIP swivel threads
- Do not twist or kink flexible connector

Item Number	Item Description	Pkg Type	Min Qty	Case Qty	Price
<b>FIP x FSWT</b>					
634-315	3/4" FIP Swivel x 3/4" FSWT, 15"	B	12	12	\$15.39
634-318	3/4" FIP Swivel x 3/4" FSWT, 18"	B	12	12	\$16.69
634-324	3/4" FIP Swivel x 3/4" FSWT, 24"	B	12	12	\$20.15
<b>FIP X FIP</b>					
634-112	3/4" FIP x 3/4" FIP Swivel, 12"	B	12	12	\$15.22
634-112PK5	3/4" FIP x 3/4" FIP Swivel, 12"	BI	5	5	\$15.32
634-115	3/4" FIP Swivel x 3/4" FIP Swivel, 15"	B	12	12	\$17.39
634-118	3/4" FIP Swivel x 3/4" FIP Swivel, 18"	B	12	12	\$18.69
634-118PK5	3/4" FIP x 3/4" FIP Swivel, 18"	BI	5	5	\$18.79
634-124	3/4" FIP x 3/4" FIP Swivel, 24"	B	12	12	\$22.15
634-124PK5	3/4" FIP x 3/4" FIP Swivel, 24"	BI	5	5	\$22.25



634-318



634-115

## Water Heater Connector

### FIP Swivel With Expansion Tank Branch

- DO NOT use pipe dope on FIP swivel threads

Item Number	Item Description	Pkg Type	Min Qty	Case Qty	Price
633-G3TM11	3/4" x 3/4" FIP Swivel w/ 3/4" MIP Branch, 11"	B	25	25	\$35.56
633-G3TM15	3/4" x 3/4" FIP Swivel w/ 3/4" MIP Branch, 15"	B	25	25	\$39.40
633-G4TM15	1" x 3/4" FIP Swivel w/ 3/4" MIP Branch, 15"	B	25	25	\$50.40



633-G3TM15

## Water Heater Connector

### Valved With Expansion Tank Branch, Full Port

- DO NOT use pipe dope on FIP swivel threads

Item Number	Item Description	Pkg Type	Min Qty	Case Qty	Price
<b>MALE SWEAT</b>					
633-G3TM18FP	3/4" FIP Swivel x 3/4" MSWT, w/ 3/4" MIP Branch, 18"	B	1	25	\$73.78
<b>FULL SLIP</b>					
633-G3TM18FPF	3/4" FIP Swivel x 3/4" Full Slip, w/ 3/4" MIP Branch, 18"	B	1	25	\$75.28



633-G3TM18FP



633-G3TM18FPF

Supply

Drainage

Support

Specialties

Appendix



634-3F312

## Water Heater Connector

### Corrugated Flexible SS Connectors

- DO NOT use pipe dope on FIP swivel threads
- Do not twist or kink flexible connector

Item Number	Item Description	Pkg Type	Min Qty	Case Qty	Price
634-3F3F12	3/4" FIP x 3/4" FIP x 12", Stainless Steel	BI	10	40	\$12.80
634-3F3F18	3/4" FIP x 3/4" FIP x 18", Stainless Steel	BI	10	40	\$15.20
634-3F3F24	3/4" FIP x 3/4" FIP x 24", Stainless Steel	BI	10	40	\$17.60



687-3SMFH



687-T3MSM



648-3SM

## Adapters

Item Number	Item Description	Pkg Type	Min Qty	Case Qty	Price
<b>CROSS ADAPTERS</b>					
687-3SFMH	Cross Adapter - 3/4" FIP Swivel X 3/4" FIP X 3/4" MIP X 3/4" MHT w/ Cap	BI	5	5	\$22.00
687-3SMFH	Cross Adapter - 3/4" FIP Swivel X 3/4" MIP X 3/4" FIP X 3/4" MHT w/ Cap	BI	5	5	\$22.00
687-3SMMH	Cross Adapter - 3/4" FIP Swivel X 3/4" MIP X 3/4" MIP X 3/4" MHT w/ Cap	BI	5	5	\$22.00
<b>CROSS ADAPTER KITS</b>					
687-3SMKIT	Cross Adapter Kit - Includes 648-3SM / 687-3SMFH / 687-3SMMH	BI	5	5	\$72.00
687-3SMKIT2	Cross Adapter Kit - Includes (2) 648-3SM / 687-3SMFH / 687-3SMMH / 687-PVLV	B	5	5	\$116.02
687-PVLV	3/4" Pressure Relief Valve	BI	5	5	\$16.02
<b>TEE ADAPTERS</b>					
687-T3MMS	TEE Adapter 3/4" MIP X 3/4" MIP X 3/4" FIPS	B	5	5	\$20.00
687-T3MSM	Tee Adapter 3/4" MIP x 3/4" FIPS x 3/4" MIP	B	5	5	\$20.00
687-T3MSS	TEE Adapter 3/4" MIP X 3/4" FIPS X 3/4" FIPS	B	5	5	\$20.00
<b>VALVES</b>					
648-3SM	3/4" FIPS x 3/4" MIP	BI	5	5	\$28.00
648-3SW	3/4" FIPS x 3/4" F1960	BI	5	5	\$28.00
648-3SX	3/4" FIPS x 3/4" F1807	X	5	5	\$33.66
<b>CHECK VALVE KIT</b>					
687-3CVKIT	3/4" Check Valve Kit	BI	1	400	\$1.80

## Water Softener Connector

### Corrugated SS Connectors

- DO NOT use pipe dope on FIP swivel threads
- Do not twist or kink flexible connector



634-4F3F18

Item Number	Item Description	Pkg Type	Min Qty	Case Qty	Price
634-4F3F18	1" FIP x 3/4" FIP x 18", Stainless Steel	BI	10	40	\$15.20
634-4F4F18	1" FIP x 1" FIP x 18", Stainless Steel	BI	10	40	\$22.20

### Heat Trap Loop

Item Number	Item Description	Pkg Type	Min Qty	Case Qty	Price
636-3TR	3/4" MSWT × 3/4" MSWT	B	25	25	\$24.24



636-3TR

### Water Heater Stub Out Loop

Item Number	Item Description	Pkg Type	Min Qty	Case Qty	Price
636-3L10888	3/4" MSWT	B	10	10	\$55.52
636-4L10888	1" MSWT	B	10	10	\$74.87



636-L3888

### Add-A-Line™

#### Full Slip Valve Tee

· DO NOT use pipe dope on comp. threads

Item Number	Item Description	Pkg Type	Min Qty	Case Qty	Price
<b>COMPRESSION TRUNK</b>					
601-G20CV	5/8" O.D. Comp × 1/4" OD Comp	Cl	6	6	\$35.89
601-G21CV	5/8" O.D. Comp × 3/8" OD Comp	Cl	6	6	\$39.77
601-G30CV	7/8" O.D. Comp × 1/4" OD Comp	Cl	6	6	\$46.70



601-G20CV

### Water Service Connectors

· DO NOT use pipe dope on FIP swivel threads

Item Number	Item Description	Pkg Type	Min Qty	Case Qty	Price
<b>POLY WATER SERVICE CONNECTOR</b>					
646-GP4312FD	1" IPS-ID Barb × 3/4" MIP, 12"	B	25	25	\$91.49
646-GP4412FD	1" IPS-ID Barb × 1" MIP, 12"	B	25	25	\$119.54



646-GP4312FD

Supply

Drainage

Support

Specialties

Appendix

Supply

Drainage

Support

Specialties

Appendix



### Water Meter Adapters

Item Number	Item Description	Pkg Type	Min Qty	Case Qty	Price
<b>WATER METER EXTENSION NIPPLE</b>					
692-1308	3/4" MIP x 1" FIP Swivel, 8"	B	25	25	\$31.24
<b>BRASS WATER METER ADAPTER</b>					
969-014440304001	1" FIP x 3/4" MIP w/ Washer, 1/Bag	BI	2	24	\$27.06

### Sweat Brass Ball Valve

Item Number	Item Description	Pkg Type	Min Qty	Case Qty	Price
<b>FULL PORT-W/SWL</b>					
648-3SM	3/4" FIPS x 3/4" MIP	BI	5	5	\$28.00
648-3SW	3/4" FIPS x 3/4" F1960	BI	5	5	\$28.00
648-3SX	3/4" FIPS x 3/4" F1807	X	5	5	\$33.66
<b>THERMAL EXPANSION VALVE - 125 PSI</b>					
648-WG3CR	3/4" F1960 x 3/4" FSWT, 3/8" Comp. Port	BI	6	6	\$40.00
648-WG3HR	3/4" F1960 x 3/4" FSWT, 3/8" Hose Barb Port	BI	6	6	\$40.00
648-WG3WR	3/4" F1960 x 3/4" FSWT, 1/2" F1960 Port	BI	6	6	\$40.00
648-XG3CR	3/4" F1807 x 3/4" FSWT, 3/8" Comp. Port	BI	6	6	\$40.00
648-XG3HR	3/4" F1807 x 3/4" FSWT, 3/8" Hose Barb Port	BI	6	6	\$40.00
648-XG3XR	3/4" F1807 x 3/4" FSWT, 1/2" F1807 Port	BI	6	6	\$40.00
<b>THERMAL EXPANSION VALVE - ADJUSTABLE, FULL PORT</b>					
648-3SMARX	3/4" FIP Swivel x 3/4" MIP, 1/2" F1807 Port (80-125 PSI)	BI	6	6	\$45.00
<b>ADJUSTABLE REPLACEMENT RELIEF PORT</b>					
648-ARX	1/8" MIP x 1/2" F1807 (80-125 PSI)	BI	6	6	\$9.80

### Brass Stop & Waste Valve

Item Number	Item Description	Pkg Type	Min Qty	Case Qty	Price
111-G22	1/2" FSWT	B	10	100	\$9.96
111-G23	3/4" FSWT	B	10	100	\$11.94



**Brass Boiler Drain**

Item Number	Item Description	Pkg Type	Min Qty	Case Qty	Price
<b>LEADED</b>					
113-32	1/2" MIP/FSWT × 3/4" MHT	BI	10	100	\$12.24
113-33	3/4" MIP × 3/4" MHT	BI	10	100	\$13.67



113-33

**Sillcock**

**Standard**

**Related Products**

PDQ™ Sillcock p 129

Item Number	Item Description	Pkg Type	Min Qty	Case Qty	Price
<b>1/2" FIP - LEADED</b>					
117-12	1/2" FIP × 3/4" Male Hose Thread	B	10	100	\$14.03
<b>1/2" FSWT - LEADED</b>					
117S2	1/2" FSWT × 3/4" Male Hose Thread	BI	10	100	\$21.36



117-12



117S2

**Frost-Proof Anti-Siphon Sillcock**

Item Number	Item Description	Pkg Type	Min Qty	Case Qty	Price
<b>MULTI-TURN - LEADED</b>					
118M204	1/2" MIP/FSWT × 3/4" MHT, 4"	BI	1	40	\$31.54
118M206	1/2" MIP/FSWT × 3/4" MHT, 6"	BI	1	40	\$32.80
118M208	1/2" MIP/FSWT × 3/4" MHT, 8"	BI	1	40	\$33.44
118M210	1/2" MIP/FSWT × 3/4" MHT, 10"	BI	1	40	\$35.52
118M212	1/2" MIP/FSWT × 3/4" MHT, 12"	BI	2	40	\$36.79
<b>1/4 TURN - LEADED</b>					
119-204	1/2" MIP × 3/4" MHT × 1/2" FSWT, 4"	B	1	25	\$53.06
119-206	1/2" MIP × 3/4" MHT × 1/2" FSWT, 6"	B	1	25	\$58.04
119-208	1/2" MIP × 3/4" MHT × 1/2" FSWT, 8"	B	1	25	\$59.97
119-210	1/2" MIP × 3/4" MHT × 1/2" FSWT, 10"	B	1	25	\$63.80
119-210CPK	5/8" O.D. Comp. × 3/4" MHT, 10"	CI	5	5	\$64.05
119-212	1/2" MIP × 3/4" MHT × 1/2" FSWT, 12"	B	1	25	\$71.45



118M208



119-210



119-210CPK

Supply

Drainage

Support

Specialties

Appendix



118-01



118-07



118-08



119-01



119-0904



117-03

### Frost-Proof Sillcock Replacement Parts

Item Number	Item Description	Pkg Type	Min Qty	Case Qty	Price
<b>118 SERIES</b>					
118-01	Sillcock Handle, Die Cast	B	12	12	\$3.64
118-02	Handle Screw	B	12	12	\$0.32
118-03	Faceplate And Stem Packing Washers	B	1	1	\$1.77
118-04	Stem Packing	B	12	100	\$0.54
118-05	Neoprene Seat Washer	B	12	12	\$0.18
118-06	Seat Washer Screw	B	1	1	\$0.57
118-07	Stem Bottom Assembly Parts: S.S. Spring, O-Ring, Spring Seat, Flat Gasket, Retainer Cup, Stem Packing, Seat Screw	B	1	1	\$4.76
118-08	Vacuum Breaker Repair Kit: Cap, Plunger, O-Ring	B	1	100	\$4.47
118-0904	4" Complete Stem Assembly: Includes Stem Bottom Assembly	B	1	1	\$14.13
118-0906	6" Complete Stem Assembly: Includes Stem Bottom Assembly	B	1	1	\$14.13
118-0908	8" Complete Stem Assembly: Includes Stem Bottom Assembly	B	1	1	\$14.80
118-0910	10" Complete Stem Assembly: Includes Stem Bottom Assembly	B	1	1	\$15.82
118-0912	12" Complete Stem Assembly: Includes Stem Bottom Assembly	B	1	1	\$16.49
<b>119 SERIES</b>					
119-00	Gray Flange	B	25	25	\$0.96
119-01	Handle Assembly And Screw	B	10	10	\$3.20
119-03	Packing Nut	B	10	10	\$2.66
119-04	Packing	B	25	25	\$0.87
119-07	Cartridge Assembly	B	1	100	\$17.42
119-08	Vacuum Breaker Kit	B	6	6	\$5.11
119-08C	Vacuum Breaker Cap, Chrome-Plated	B	6	6	\$3.76
119-0904	4" Stem, 5-1/2" Total Length	B	10	10	\$5.25
119-0906	6" Stem, 7-1/2" Total Length	B	10	10	\$6.28
119-0908	8" Stem, 9-1/2" Total Length	B	10	10	\$6.86
119-0910	10" Stem, 11-1/2" Total Length	B	10	10	\$8.86
119-0912	12" Stem, 13-1/2" Total Length	B	10	10	\$8.55
119-10	Jam Nut	BI	6	6	\$3.02

### Vacuum Breaker

Item Number	Item Description	Pkg Type	Min Qty	Case Qty	Price
<b>LEADED</b>					
117-03	3/4" Female Hose Thread x 3/4" Male Hose Thread	BI	20	240	\$9.07

## Thermostatic Mixing Valve

**Related Products**

OxBox™ TMV p 174

Item Number	Item Description	Pkg Type	Min Qty	Case Qty	Price
<b>VALVE</b>					
<b>120-TM3F</b>	3/8" Comp. Inlets x 3/8" Comp. Outlets, Capped	BI	1	10	\$114.00
<b>REPAIR KITS</b>					
<b>120-TM3F-1</b>	THERMOSTATIC MIX VLV SCREEN KIT, 2/BG	BI	1	500	\$0.87
120-TM3F-2	THERMOSTATIC MIX VLV PISTON REPAIR KIT, 2/BG	BI	1	300	\$14.65
120-TM3F-3	THERMOSTATIC MIX VLV CHECK VALVE REPAIR KIT, 2/BG	BI	1	500	\$4.39



120-TM3F

Supply

Drainage

Support

Specialties

Appendix

Supply



### 1/2" Male Sweat Branch, Manifold

#### 1" MSWT × 1" MSWT Trunk

· Do not recirculate back through any manifold branch. Do not modify manifold. Doing so will void warranty

Item Number	Item Description	Pkg Type	Min Qty	Case Qty	Price
678-20344	1/2" MSWT, 3 Port	BI	10	10	\$24.98
678-20644	1/2" MSWT, 6 Port	BI	10	10	\$42.83
678-21244	1/2" MSWT, 12 Port	B	10	10	\$78.43

Drainage

Support



### 1/2" Male Sweat Branch, Manifold

#### 1" MSWT × 1" FSWT Trunk

Item Number	Item Description	Pkg Type	Min Qty	Case Qty	Price
678-20242	1/2" MSWT, 2 Port	BI	10	10	\$20.35
678-20342	1/2" MSWT, 3 Port	BI	10	10	\$26.30
678-20442	1/2" MSWT, 4 Port	BI	10	10	\$32.25
6784L-11313	1/2" MSWT, 11 Port, 3" O.C.	BI	5	5	\$82.24

Specialties

Appendix

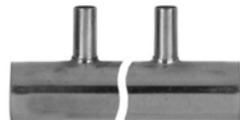

### 3/4" Male Sweat Branch, Manifold

#### 1-1/4" MSWT × 1-1/4" MSWT Trunk

· Do not recirculate back through any manifold branch. Do not modify manifold. Doing so will void warranty

Item Number	Item Description	Pkg Type	Min Qty	Case Qty	Price
6795L-12333	3/4" MSWT, 12 Port, 3" O.C.	BI	1	5	\$260.51

### 3/4" Male Sweat Branch, Manifold

#### 1-1/2" MSWT × 1-1/2" FSWT Trunk

· Do not recirculate back through any manifold branch. Do not modify manifold. Doing so will void warranty



Item Number	Item Description	Pkg Type	Min Qty	Case Qty	Price
6796L-12333	3/4" MSWT, 12 Port, 3" O.C.	BI	1	5	\$261.04

### 3/4" Male Sweat Branch, Manifold

#### 2" MSWT × 2" MSWT Trunk

Item Number	Item Description	Pkg Type	Min Qty	Case Qty	Price
6797L-12333	3/4" MSWT, 12 Port, 3" O.C.	BI	1	4	\$261.56



### 3/4" Female Sweat Branch, Manifold

#### 1-1/4" MSWT × 1-1/4" MSWT Trunk

- Do not recirculate back through any manifold branch. Do not modify manifold. Doing so will void warranty

Item Number	Item Description	Pkg Type	Min Qty	Case Qty	Price
67745L-08334	3/4" FSWT, 8 Port, 4" O.C.	BI	1	5	\$169.39



### 1/2" MIP Branch, Manifold

#### 1" MSWT × 1" MSWT Trunk

- Do not recirculate back through any manifold branch. Do not modify manifold. Doing so will void warranty

Item Number	Item Description	Pkg Type	Min Qty	Case Qty	Price
675-20544	1/2" MIP, 5 Port	B	10	10	\$62.23



### 1/2" MIP Branch, Manifold

#### 1" MSWT × 1" FSWT Trunk

- Do not recirculate back through any manifold branch. Do not modify manifold. Doing so will void warranty

Item Number	Item Description	Pkg Type	Min Qty	Case Qty	Price
675-20442	1/2" MIP, 4 Port	B	10	10	\$60.13



Supply

Drainage

Support

Specialties

Appendix



### 1/2" MIP/FSWT Ball Valve Branch, Manifold 1" MSWT × 1" MSWT Trunk

· Do not recirculate back through any manifold branch. Do not modify manifold. Doing so will void warranty

Item Number	Item Description	Pkg Type	Min Qty	Case Qty	Price
<b>LEADED</b>					
675-V20244	1/2" MIP/FSWT Ball Valve, 2 Port	BI	1	10	\$63.13
675-V20344	1/2" MIP/FSWT Ball Valve, 3 Port	BI	1	10	\$91.13
675-V20544	1/2" MIP/FSWT Ball Valve, 5 Port	BI	1	10	\$146.48



### 1/2" MIP/FSWT Ball Valve Branch, Manifold 1" MSWT × 1" FSWT Trunk

· Do not recirculate back through any manifold branch. Do not modify manifold. Doing so will void warranty

Item Number	Item Description	Pkg Type	Min Qty	Case Qty	Price
<b>LEADED</b>					
675-V20442	1/2" MIP/FSWT Ball Valve, 4 Port	BI	1	10	\$120.44

### Sweat Shower-Up™ Kit

· For individual product details, see product pages

**Related Products**

Shower WallNut™ p 640

Item Number	Item Description	Pkg Type	Min Qty	Case Qty	Price
693-13155301	(1) 608-L2508, (1) 613-87, (2) 632X263, (1) 523-2434, (1) 525-16WLB	BI	12	12	\$70.78
<b>693-13755301</b>	(1) 608-L2508, (1) 613-87, (2) 632WG263, (1) 523-2434, (1) 525-16WLB	BI	1	12	\$82.20



### Sweat Water Heater Connector Kit

· DO NOT use pipe dope on FIP swivel threads  
 · For individual product details, see product pages

Item Number	Item Description	Pkg Type	Min Qty	Case Qty	Price
<b>694-G21012091</b>	(1) 633-312, (1) 633-G3TM15, (1) 631-G305FP	BI	1	10	\$108.83



Supply

Drainage

Support

Specialties

Appendix





# PDQ™ Push Fit System

PDQ™ Push - Fittings, Adapters & Connectors

PDQ™ Push Preformed Copper & Valves

PDQ™ Push Fit Manifolds

PDQ™ helps contractors get *Plumbing Done Quickly*.

Sioux Chief's PDQ push fit system offers a fast, reliable, tool-free connection solution for CTS copper and CPVC, or SDR9 PEX tubing. PDQ Fittings are made to the ASSE 1061 *Performance Requirements for Push-Fit Fittings*, and can be used in potable water or hydronic heating applications.

**Important Notes About Sioux Chief PDQ Fittings:**

PDQ fittings are not compatible with chrome or nickel-plated stub outs and stub out elbows.

A tube stiffener must be used when installing PEX tube into a PDQ fitting.

Do Not apply heat to PDQ fittings



See complete installation instructions at [www.siouxchief.com](http://www.siouxchief.com)

				
<b>642QG2</b> Page 123	<b>641QG333</b> Page 123	<b>645QG4</b> Page 124	<b>600QG406</b> Page 124	<b>605QG3</b> Page 125
				
<b>646QG3</b> Page 125	<b>633Q03</b> Page 125	<b>647QG2</b> Page 126	<b>632QG222M</b> Page 126	<b>647QG2E3</b> Page 126
				
<b>632QG222F</b> Page 126	<b>603Q2</b> Page 127	<b>305Q2</b> Page 127	<b>630Q248</b> Page 128	<b>630Q248E</b> Page 128
				
<b>632Q263X</b> Page 128	<b>633Q06FP</b> Page 128	<b>634Q418</b> Page 129	<b>634Q418FP</b> Page 129	<b>601Q30V</b> Page 129
				
<b>648QG3</b> Page 129	<b>117Q22</b> Page 129	<b>119Q210</b> Page 130	<b>694Q312620</b> Page 130	<b>672Q0490</b> Page 131

## Male Sweat Fittings

### PRESS-FIT

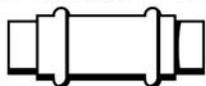

### COMPATIBLE

All Sioux Chief male sweat, preformed copper fittings are compatible with press-fit systems and all push fit systems. Do not use push fittings with nickel-plated stub outs.

## Lead-Free Compliant



Products made from 'Copper' or 'NL/DZR' material comply with NSF-61 & 372 and with the California No Lead Plumbing Law.

**Push Fit Elbow**

Item Number	Item Description	Pkg Type	Min Qty	Case Qty	Price
<b>NL/DZR BRASS</b>					
642QG2	1/2" × 1/2"	Cl	12	12	\$14.97
642QG3	3/4" × 3/4"	Cl	12	12	\$19.86
642QG32	3/4" × 1/2"	Cl	6	6	\$19.28
642QG4	1" × 1"	Cl	6	6	\$37.00
642QG43	1" × 3/4"	Cl	6	6	\$34.07
642QG5	1-1/4" × 1-1/4"	Cl	3	3	\$91.77
642QG6	1-1/2" × 1-1/2"	Cl	3	3	\$126.55
642QG7	2" × 2"	Cl	3	3	\$170.94



642QG2



642QG32

**Push Fit Tee**

Item Number	Item Description	Pkg Type	Min Qty	Case Qty	Price
<b>STANDARD TEE - NL/DZR BRASS</b>					
641QG222	1/2" × 1/2" × 1/2"	Cl	12	12	\$18.92
641QG222F	1/2" Push Fit × 1/2" Push Fit × 1/2" FIP	Cl	6	6	\$24.37
641QG222M	1/2" Push Fit × 1/2" Push Fit × 1/2" MIP	Cl	6	6	\$24.04
641QG333	3/4" × 3/4" × 3/4"	Cl	12	12	\$26.49
641QG333F	3/4" Push Fit × 3/4" Push Fit × 3/4" FIP	Cl	6	6	\$31.57
641QG333M	3/4" Push Fit × 3/4" Push Fit × 3/4" MIP	Cl	6	6	\$30.85
641QG444	1" × 1" × 1"	Cl	6	6	\$44.79
641QG555	1-1/4" × 1-1/4" × 1-1/4"	Cl	3	3	\$133.90
641QG666	1-1/2" × 1-1/2" × 1-1/2"	Cl	3	3	\$192.28
641QG777	2" × 2" × 2"	Cl	3	3	\$249.87
<b>REDUCING TEE - NL/DZR BRASS</b>					
641QG322	3/4" × 1/2" × 1/2"	Cl	12	12	\$25.37
641QG323	3/4" × 1/2" × 3/4"	Cl	6	6	\$26.57
641QG332	3/4" × 3/4" × 1/2"	Cl	6	6	\$25.40
641QG424	1" × 1/2" × 1"	Cl	6	6	\$43.34
641QG443	1" × 1" × 3/4"	Cl	6	6	\$45.75
<b>BULLHEAD TEE - NL/DZR BRASS</b>					
641QG223	1/2" × 1/2" × 3/4"	Cl	6	6	\$25.10
641QG224	1/2" × 1/2" × 1"	Cl	6	6	\$28.74
641QG334	3/4" × 3/4" × 1"	Cl	6	6	\$37.39



641QG222



641QG323



641QG223

Supply

Drainage

Support

Specialties

Appendix



641Q3-3Q2

### Push Fit Transition Tee

- For mechanical connection only - Do Not Solder
- Applying heat or cutting this fitting voids warranty

Item Number	Item Description	Pkg Type	Min Qty	Case Qty	Price
<b>COPPER</b>					
641Q3-3Q2	3/4" Push Fit × 3/4" CTS × 1/2" Push Fit	CI	1	6	\$37.05



645Q2-3

### Push Fit Transition Adapter

- For mechanical connection only - Do Not Solder
- Applying heat or cutting this fitting voids warranty

Item Number	Item Description	Pkg Type	Min Qty	Case Qty	Price
<b>COPPER</b>					
645Q2-3	1/2" Push Fit × 3/4" CTS, 1/Bag	CI	10	10	\$16.15
645Q3-2	3/4" Push Fit × 1/2" CTS, 1/Bag	CI	10	10	\$18.79

### Push Fit Coupling



645QG2



645QG32

Item Number	Item Description	Pkg Type	Min Qty	Case Qty	Price
<b>NL/DZR BRASS</b>					
645QG2	1/2" × 1/2"	CI	12	12	\$13.57
645QG3	3/4" × 3/4"	CI	12	12	\$17.17
645QG32	3/4" × 1/2"	CI	6	6	\$16.78
645QG4	1" × 1"	CI	6	6	\$36.25
645QG43	1" × 3/4"	CI	6	6	\$41.79
645QG5	1-1/4" × 3/4"	CI	3	3	\$94.86
645QG54	1-1/4" × 1"	CI	3	3	\$87.59
645QG6	1-1/2" × 1-1/2"	CI	3	3	\$131.82
645QG65	1-1/2" × 1-1/4"	CI	3	3	\$121.63
645QG7	2" × 2"	CI	3	3	\$192.60
645QG76	2" × 1-1/2"	CI	3	3	\$182.41

### Push Fit Slip Coupling



600QG406

Item Number	Item Description	Pkg Type	Min Qty	Case Qty	Price
<b>COPPER</b>					
600Q206	1/2" Slip Coupling, Copper	BI	6	6	\$20.44
600Q306	3/4" Slip Coupling, Copper	BI	6	6	\$25.07
<b>NL/DZR BRASS</b>					
600QG406	1" Slip Coupling, No-Lead Brass	BI	6	6	\$53.52

### Push Fit Cap

Item Number	Item Description	Pkg Type	Min Qty	Case Qty	Price
<b>NL/DZR BRASS</b>					
605QG2	1/2" Push Fit	Cl	12	12	\$10.38
605QG3	3/4" Push Fit	Cl	6	6	\$12.99
605QG4	1" Push Fit	Cl	6	6	\$28.29
605QG5	1-1/4" Push Fit	Cl	3	3	\$60.27
605QG6	1-1/2" Push Fit	Cl	3	3	\$72.54
605QG7	2" Push Fit	Cl	3	3	\$90.09



605QG3

### Push Fit Straight Adapter

#### MIP

Item Number	Item Description	Pkg Type	Min Qty	Case Qty	Price
<b>NL/DZR BRASS</b>					
646QG2	1/2" Push Fit × 1/2" MIP	Cl	12	12	\$11.14
646QG3	3/4" Push Fit × 3/4" MIP	Cl	12	12	\$13.64
646QG32	1/2" Push Fit × 3/4" MIP	Cl	6	6	\$13.54
646QG34	1" Push Fit × 3/4" MIP	Cl	6	6	\$23.85
646QG4	1" Push Fit × 1" MIP	Cl	6	6	\$27.92
646QG5	1-1/4" Push Fit × 1-1/4" MIP	Cl	3	3	\$76.82
646QG6	1-1/2" Push Fit × 1-1/2" MIP	Cl	3	3	\$110.20
646QG7	2" Push Fit × 2" MIP	Cl	3	3	\$132.68



646QG2

### Push Fit Straight Adapter

#### FIP Swivel Adapter

· DO NOT use pipe dope on FIP swivel threads

Item Number	Item Description	Pkg Type	Min Qty	Case Qty	Price
<b>NL/DZR</b>					
633Q03	3/4" Push Fit × 3/4" FIP Swivel, 2"	Bl	12	12	\$17.42
637Q2	1/2" Push Fit × 1/2" FIP Swivel	Bl	12	12	\$10.10



633Q03

Supply

Drainage

Support

Specialties

Appendix



647QG2

### Push Fit Straight Adapter

#### FIP

Item Number	Item Description	Pkg Type	Min Qty	Case Qty	Price
<b>NL/DZR BRASS</b>					
647QG2	1/2" Push Fit × 1/2" FIP	CI	12	12	\$11.80
647QG3	3/4" Push Fit × 3/4" FIP	CI	12	12	\$15.06
647QG32	1/2" Push Fit × 3/4" FIP	CI	6	6	\$14.97
647QG34	1" Push Fit × 3/4" FIP	CI	6	6	\$25.46
647QG4	1" Push Fit × 1" FIP	CI	12	12	\$28.88
647QG43	3/4" Push Fit × 1" FIP	CI	6	6	\$27.29
647QG5	1-1/4" Push Fit × 1-1/4" FIP	CI	3	3	\$83.20
647QG6	1-1/2" Push Fit × 1-1/2" FIP	CI	3	3	\$122.24
647QG7	2" Push Fit × 2" FIP	CI	3	3	\$146.75

### Push Fit Elbow Adapter

#### MIP



632QG222M

Item Number	Item Description	Pkg Type	Min Qty	Case Qty	Price
<b>NL/DZR BRASS</b>					
632QG222M	1/2" Push Fit × 1/2" MIP	BI	6	6	\$15.09

### Push Fit Elbow Adapter

#### FIP



632QG222F

Item Number	Item Description	Pkg Type	Min Qty	Case Qty	Price
<b>NL/DZR BRASS</b>					
632QG222F	1/2" Push Fit × 1/2" FIP	BI	6	6	\$15.31
647QG2E3	1/2" Push Fit × 1/2" FIP Drop-Ear	CI	6	6	\$16.10

**Poly Tube Stiffener**

Item Number	Item Description	Pkg Type	Min Qty	Case Qty	Price
603Q2	1/2", 6/Bag	Cl	15	15	\$4.40
603Q3	3/4", 6/Bag	Cl	15	15	\$7.26
603Q4	1", 6/Bag	Cl	15	15	\$9.72



603Q2

**Stainless Steel Tube Stiffener**

Item Number	Item Description	Pkg Type	Min Qty	Case Qty	Price
280-A266537	1/2"	B	10	2500	\$2.35
280-A266607	3/4"	B	50	1000	\$8.85
280-A266617	1"	B	50	1000	\$10.06
280-A266627	1-1/4"	B	25	25	\$13.73



280-A266537

**Push Fit Disconnect Tools**

Item Number	Item Description	Pkg Type	Min Qty	Case Qty	Price
305Q2	1/2", 1/Bag	Cl	24	24	\$2.41
305Q23PK1	1/2" & 3/4", 1 Pair/Bag	Bl	12	12	\$4.80
305Q3	3/4", 1/Bag	Cl	24	24	\$2.41
305Q4	1", 1/Bag	Cl	12	12	\$2.70
305Q4PK1	1", 1/Bag	Bl	5	400	\$2.95
305Q5	1-1/4", 1/Bag	Bl	5	5	\$26.60
305Q6	1-1/2", 1/Bag	Bl	1	1	\$28.33
305Q7	2", 1/Bag	Bl	1	1	\$28.33



305Q2

Supply

Drainage

Support

Specialties

Appendix

Supply



630Q248

### Push Fit Stub Out Elbow

· Do not allow PDQ portion of fitting to be heated

Item Number	Item Description	Pkg Type	Min Qty	Case Qty	Price
630Q248	1/2" Push Fit, 4" × 8"	BI	20	20	\$16.79
630Q368	3/4" Push Fit, 6" × 8"	BI	10	10	\$19.27

Drainage



630Q248E

### Push Fit Stub Out Elbow

#### Stub out With Square O Strap

· Do not allow PDQ portion of fitting to be heated

Item Number	Item Description	Pkg Type	Min Qty	Case Qty	Price
630Q248E	1/2" Push Fit, 4" × 8", w/ Strap	BI	10	10	\$17.82
630Q4910E	1" Push Fit, 9" × 10", w/ Strap	BI	10	10	\$37.19

Support

Specialties



632Q263Y

### Push Fit Tub/Shower Connector

· DO NOT use pipe dope on FIP swivel threads

Item Number	Item Description	Pkg Type	Min Qty	Case Qty	Price
632Q263	1/2" Push Fit, 6" × 3"	BI	20	20	\$15.08
632Q263X	1/2" Push Fit × 1/2" MIP Swivel, 6" × 3"	BI	20	20	\$21.97
632Q263Y	1/2" Push Fit × 1/2" FIP Swivel, 6" × 3"	BI	20	20	\$21.28

Appendix



633Q18

### Push-Fit Water Heater Connector

#### FIP Swivel Straight

· DO NOT use pipe dope on FIP swivel threads

Item Number	Item Description	Pkg Type	Min Qty	Case Qty	Price
<b>STANDARD</b>					
633Q18	3/4" Push Fit × 3/4" FIP Swivel, 18"	BI	10	10	\$32.78
<b>VALVED, FULL PORT</b>					
633Q06FP	3/4" Push Fit × 3/4" FIP Swivel, 6"	BI	10	10	\$56.26
633Q18FP	3/4" Push Fit × 3/4" FIP Swivel, 18"	BI	10	10	\$67.78



633Q06FP



## Push-Fit Water Heater Connector

### Straight Flexible Copper FIP Swivel

- DO NOT use pipe dope on FIP swivel threads
- Do not twist or kink flexible connector

Item Number	Item Description	Pkg Type	Min Qty	Case Qty	Price
<b>STANDARD</b>					
634Q418	3/4" Push Fit × 3/4" FIP Swivel, 18"	B	12	12	\$27.19
<b>VALVED, FULL PORT</b>					
634Q418FP	3/4" Push Fit × 3/4" FIP Swivel, 18"	B	10	10	\$62.19



## Add-A-Line™

### Push-Fit Tee

- Applying heat or cutting this fitting voids warranty
- For mechanical connection only - Do Not Solder
- DO NOT use pipe dope on comp. threads

Item Number	Item Description	Pkg Type	Min Qty	Case Qty	Price
601Q20V	1/2" Push Fit × 1/4" OD Comp	BI	6	6	\$40.25
601Q30V	3/4" Push Fit × 1/4" OD Comp	BI	6	6	\$52.21



## Push Fit Brass Ball Valve

Item Number	Item Description	Pkg Type	Min Qty	Case Qty	Price
<b>FULL PORT</b>					
648QG2	1/2" Push Fit	CI	12	12	\$33.43
648QG3	3/4" Push Fit	CI	12	12	\$41.28
648QG4	1" Push Fit	CI	6	6	\$60.63



## Push Fit Sillcock

Item Number	Item Description	Pkg Type	Min Qty	Case Qty	Price
<b>LEADED</b>					
117Q22	1/2" Push Fit	BI	6	6	\$23.72



Supply

Drainage

Support

Specialties

Appendix

Supply



119Q208

### Push Fit Frost-Proof Sillcock

**Related Products**

Frost-Proof Sillcock Replacement Parts p 114

Item Number	Item Description	Pkg Type	Min Qty	Case Qty	Price
<b>1/4 TURN - LEADED</b>					
119Q208	1/2" Push Fit, 8"	B	5	5	\$80.57
119Q210	1/2" Push Fit, 10"	B	5	5	\$84.72

Drainage

Support



694Q312620

### Push Fit Water Heater Connector Kit

· DO NOT use pipe dope on FIP swivel threads

Item Number	Item Description	Pkg Type	Min Qty	Case Qty	Price
694Q312620	(1) 633Q03, (1) 633Q06FP	BI	10	10	\$75.68
694Q464120	(1) 634Q418, (1) 634Q418FP	BI	10	10	\$91.38

Specialties

Appendix

## 1/2" Push Fit Branch, Manifold

### 3/4" Push Fit × Spun Closed Trunk

· Do not recirculate back through any manifold branch. Do not modify manifold. Doing so will void warranty



Item Number	Item Description	Pkg Type	Min Qty	Case Qty	Price
672Q0490	1/2" Push Fit, 4 Port	BI	10	10	\$75.45
672Q0590	1/2" Push Fit, 5 Port	BI	10	10	\$92.20
672Q0690	1/2" Push Fit, 6 Port	BI	10	10	\$108.95

## 1/2" Push Fit Branch, Manifold

### 3/4" Push Fit × 3/4" Push Fit Trunk

· Do not recirculate back through any manifold branch. Do not modify manifold. Doing so will void warranty



Item Number	Item Description	Pkg Type	Min Qty	Case Qty	Price
672Q0499	1/2" Push Fit, 4 Port	BI	10	10	\$91.20
672Q0599	1/2" Push Fit, 5 Port	BI	10	10	\$107.95
672Q0699	1/2" Push Fit, 6 Port	BI	10	10	\$124.70

Supply

Drainage

Support

Specialties

Appendix



# Pipe Insulation

## Foam Pipe/Tube Insulation

Using foam pipe/tube insulation reduces noise, condensation, and conserves energy by reducing heat-loss. Sioux Chief's closed-cell foam insulation is made in the USA and provides the ideal combination of flexibility and rigidity for easier installation.





## Foam Pipe/Tube Insulation

### Self-Seal Seam - Black

Item Number	Item Description	Pkg Type	Min Qty	Case Qty	Price
<b>3/8" WALL</b>					
663-05838SS	5/8" ID, 1/2" CTS, 408 Ft/Box	B	1	1	\$199.82
663-07838SS	7/8" ID, 3/4" CTS, 300 Ft/Box	B	1	1	\$155.61
663-11838SS	1-1/8" ID, 1" CTS, 240 Ft/Box	B	1	1	\$148.62
663-13838SS	1-3/8" ID, 1-1/4" CTS, 192 Ft/Box	B	1	1	\$166.08
663-15838SS	1-5/8" ID, 1-1/2" CTS, 132 Ft/Box	B	1	1	\$156.15
663-21838SS	2-1/8" ID, 2" CTS, 90 Ft/Box	B	1	1	\$139.24
663-25838SS	2-5/8" ID, 2-1/2" CTS, 72 Ft/Box	B	1	1	\$142.62
<b>1/2" WALL</b>					
663-05812SS	5/8" ID, 1/2" CTS, 306 Ft/Box	B	1	1	\$198.86
663-07812SS	7/8" ID, 3/4" CTS, 240 Ft/Box	B	1	1	\$174.80
663-11812SS	1-1/8" ID, 1" CTS, 180 Ft/Box	B	1	1	\$179.87
663-13812SS	1-3/8" ID, 1-1/4" CTS, 150 Ft/Box	B	1	1	\$163.38
663-15812SS	1-5/8" ID, 1-1/2" CTS, 120 Ft/Box	B	1	1	\$153.28
663-21812SS	2-1/8" ID, 2" CTS, 84 Ft/Box	B	1	1	\$140.59
663-23812SS	2-3/8" ID, 2" IPS, 66 Ft/Box	B	1	1	\$133.02
663-25812SS	2-5/8" ID, 2-1/2" CTS, 60 Ft/Box	B	1	1	\$133.02
663-31212SS	3-1/2" ID, 3" IPS, 42 Ft/Box	B	1	1	\$192.70
<b>3/4" WALL</b>					
663-05834SS	5/8" ID, 1/2" CTS, 180 Ft/Box	B	1	1	\$228.64
663-07834SS	7/8" ID, 3/4" CTS, 156 Ft/Box	B	1	1	\$228.71
663-11834SS	1-1/8" ID, 1" CTS, 102 Ft/Box	B	1	1	\$221.73
663-13834SS	1-3/8" ID, 1-1/4" CTS, 90 Ft/Box	B	1	1	\$205.18
663-15834SS	1-5/8" ID, 1-1/2" CTS, 84 Ft/Box	B	1	1	\$240.19
663-21834SS	2-1/8" ID, 2" CTS, 54 Ft/Box	B	1	1	\$198.38
663-23834SS	2-3/8" ID, 2" IPS, 54 Ft/Box	B	1	1	\$228.55
<b>1" WALL</b>					
663-05810SS	5/8" ID, 1/2" CTS, 108 Ft/Box	B	1	1	\$181.87
663-07810SS	7/8" ID, 3/4" CTS, 90 Ft/Box	B	1	1	\$191.26
663-11810SS	1-1/8" ID, 1" CTS, 90 Ft/Box	B	1	1	\$196.33
663-13810SS	1-3/8" ID, 1-1/4" CTS, 72 Ft/Box	B	1	1	\$222.42
663-15810SS	1-5/8" ID, 1-1/2" CTS, 60 Ft/Box	B	1	1	\$156.93
663-21810SS	2-1/8" ID, 2" CTS, 48 Ft/Box	B	1	1	\$241.54
663-23810SS	2-3/8" ID, 2" IPS, 42 Ft/Box	B	1	1	\$277.04
663-25810SS	2-5/8" ID, 2-1/2" CTS, 36 Ft/Box	B	1	1	\$268.31



663-05838SS

## Foam Pipe/Tube Insulation

### Half-Slit - Black

Item Number	Item Description	Pkg Type	Min Qty	Case Qty	Price
<b>3/8" WALL</b>					
663-05838HS	5/8" ID, 1/2" CTS, 408 Ft/Box	B	1	1	\$159.98
663-07838HS	7/8" ID, 3/4" CTS, 300 Ft/Box	B	1	1	\$126.92
663-11838HS	1-1/8" ID, 1" CTS, 240 Ft/Box	B	1	1	\$116.33
663-13838HS	1-3/8" ID, 1-1/4" CTS, 192 Ft/Box	B	1	1	\$115.46



663-07838HS

Supply  
Drainage  
Support  
Specialties  
Appendix

### Foam Pipe/Tube Insulation (Cont)

#### Half-Slit - Black



663-05812HS



663-07810HS

Item Number	Item Description	Pkg Type	Min Qty	Case Qty	Price
<b>1/2" WALL</b>					
663-05812HS	5/8" ID, 1/2" CTS, 306 Ft/Box	B	1	1	\$136.82
663-07812HS	7/8" ID, 3/4" CTS, 240 Ft/Box	B	1	1	\$123.97
<b>1" WALL</b>					
663-05810HS	5/8" ID, 1/2" CTS, 108 Ft/Box	B	1	1	\$165.93
663-07810HS	7/8" ID, 3/4" CTS, 90 Ft/Box	B	1	1	\$172.65
663-11810HS	1-1/8" ID, 1" CTS, 90 Ft/Box	B	1	1	\$151.98

Supply

Drainage

Support

Specialties

Appendix



# **Arresters & Trap Primers**

**Water Hammer Arresters**

**Trap Primers**

# Arresters & Trap Primers

## Water Hammer Arresters

Sioux Chief water hammer arresters are ASSE certified to the *ANSI/ASSE 1010 Performance Requirements for Water Hammer Arresters*. AA size arrester models are IAPMO listed to cUPC and Canadian codes and standards.

Sioux Chief arresters may be installed at any angle, are approved for installation with no access panels required, and are compatible with Press-Fitting and Push-Fitting systems.



The resin used in all CPVC connections has been tested, and is monitored on an ongoing basis, to assure its chemical compatibility with FlowGuard Gold®, BlazeMaster® and Corzan® piping systems and products made with TempRite® Technology.

The FBC System Compatible Logo, FBC™, FlowGuard Gold®, BlazeMaster®, Corzan®, and TempRite® are trademarks of Lubrizol Advanced Materials, Inc. or its affiliates.

## Trap Primers

Sioux Chief mechanical trap primer valves are IAPMO listed to cUPC and ASSE certified to the *ANSI/ASSE 1018 Performance Requirements for Trap Seal Primer Valves – Potable Water Supplied*.

Gravity and Electronic trap primers are IAPMO listed to cUPC and ASSE certified to the *ANSI/ASSE 1044 Performance Requirements for Trap Seal Primer – Drainage Types and Electric Design Types*.

# Water Hammer Arresters

Sioux Chief has been an industry leader in water hammer arrester science and solutions for decades. Our arresters are continuously and rigorously tested. The simple but durable piston design provides the longest performance life of any arrester on the market

All arresters are made in the USA from copper, brass, and stainless steel materials.





**660-WG2B**  
Page 141



**660-X2B**  
Page 141



**660-HB**  
Page 141



**660-TS**  
Page 141



**660-TSWG8**  
Page 141



**660-GTX2B**  
Page 142



**660-GTC1B**  
Page 142



**660-GTR1B**  
Page 142



**652-A**  
Page 143



**652-AS**  
Page 143



**653-BC**  
Page 143



**652-AX**  
Page 144



**652-AWG**  
Page 144



**658-2004**  
Page 144



**658S2002**  
Page 144



**652-AD**  
Page 145



**695-01**  
Page 149



**695-Y52**  
Page 149



**695-D432**  
Page 149



**200-092**  
Page 150



**695-ES05**  
Page 150



**695-ER10**  
Page 151



**695-ES01**  
Page 151

## Male Sweat Fittings

**PRESS-FIT  
COMPATIBLE**

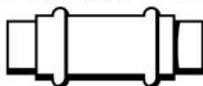

All Sioux Chief male sweat, preformed copper fittings are compatible with press-fit systems and all push fit systems. Do not use push fittings with nickel-plated stub outs.

## Lead-Free Compliant



Products made from 'Copper' or 'NL/DZR' material comply with NSF-61 & 372 and with the California No Lead Plumbing Law.

**MiniRester™**

**Straight**

· For any residential single-fixture application

Item Number	Item Description	Pkg Type	Min Qty	Case Qty	Price
660-G2	1/2" MIP, Clamshell	Cl	6	6	\$18.02
660-G2B	1/2" MIP	B	50	50	\$16.16
660-GVPX2B	1/2" F3347 PEX Press	B	50	50	\$20.88
660-S	1/2" MSWT, Clamshell	Cl	6	6	\$17.60
660-SB	1/2" MSWT	B	50	50	\$15.74
660-V82B	1/2" CPVC Male	B	50	50	\$15.44
660-WG2B	1/2" F1960 PEX	B	50	50	\$19.44
660-X2B	1/2" F1807 PEX	B	50	50	\$16.69



660-G2B



660-SB

**MiniRester™**

**Laundry Hose Tee/Toilet Fill Valve Tee**

· DO NOT use pipe dope on FIP swivel threads

Item Number	Item Description	Pkg Type	Min Qty	Case Qty	Price
660-H	3/4" Female Swivel Hose Thread × 3/4" Male Hose Thread, Clamshell	Bl	6	6	\$25.45
660-HB	3/4" Female Swivel Hose Thread × 3/4" Male Hose Thread	B	25	25	\$23.46
660-HPK2	3/4" Female Swivel Hose Thread × 3/4" Male Hose Thread, 2/Bag	Bl	20	20	\$50.90
660-TK	Female Swivel Ballcock Nut × Male Ballcock Thread, Clamshell	Cl	6	6	\$32.43
660-TKB	Female Swivel Ballcock Nut × Male Ballcock Thread	B	25	25	\$29.53



660-HB

**MiniRester™**

**Tub Shower / Stub Out Tee**

**Related Products**

3-Valve Kitchen Supply Box p 179

Item Number	Item Description	Pkg Type	Min Qty	Case Qty	Price
<b>TUB SHOWER VALVE TEE</b>					
660-TS	1/2" FSWT × 1/2" MSWT	B	25	25	\$23.77
660-TSWG	1/2" F1960 PEX × 1/2" MSWT	B	25	25	\$30.93
660-TSX	1/2" F1807 PEX × 1/2" MSWT	B	25	25	\$29.64
<b>STUB OUT TEE</b>					
660-TS8	1/2" FSWT × 1/2" × 8" Stub Out	B	25	25	\$28.72
660-TS88	1/2" FSWT × Double 1/2" × 8" Stub Out	B	25	25	\$34.27
660-TSWG8	1/2" F1960 w/ 1/2" CTS Stub Out, 8"	B	25	25	\$38.62
660-TSX88	1/2" F1807 PEX × Double 1/2" × 8" Stub Out	B	25	25	\$38.28



660-TSWG



660-TSWG8

Supply

Drainage

Support

Specialties

Appendix



660-GTX2B



660-GTW2B



660-GTC0



660-GTR1B

### MiniRester™

#### PEX Tee

- For any residential single-fixture application with PEX tube

Item Number	Item Description	Pkg Type	Min Qty	Case Qty	Price
<b>F1807 PEX</b>					
660-GTX2	1/2" F1807, Clamshell	CI	6	6	\$26.87
660-GTX2B	1/2" F1807	B	25	25	\$25.00
<b>F1960 PEX</b>					
660-GTW2B	1/2" F1960	B	25	25	\$27.72

### MiniRester™

#### Compression Tee

- For any residential single-fixture application
- DO NOT use pipe dope on comp. threads

Item Number	Item Description	Pkg Type	Min Qty	Case Qty	Price
660-GTC0	1/4" O.D Comp., Clamshell	CI	6	6	\$31.13
660-GTC0B	1/4" O.D Comp.	B	25	25	\$29.58
660-GTC1	3/8" O.D. Comp., Clamshell	CI	6	6	\$29.58
660-GTC1B	3/8" O.D. Comp.	B	25	25	\$29.58

### MiniRester™

#### Female Compression Tee

- Installs directly to supply stops
- DO NOT use pipe dope on comp. threads

Item Number	Item Description	Pkg Type	Min Qty	Case Qty	Price
660-GTR	5/8" O.D. Female Comp. × 5/8" O.D. Comp., Clamshell	CI	6	6	\$31.72
660-GTR0	1/4" O.D Female Comp. × 1/4" O.D. Comp., Clamshell	CI	6	6	\$31.13
660-GTR0B	1/4" O.D Female Comp. × 1/4" O.D. Comp.	B	25	25	\$29.58
660-GTR1	3/8" O.D. Female Comp. × 3/8" O.D. Comp., Clamshell	CI	6	6	\$31.13
660-GTR1B	3/8" O.D. Female Comp. × 3/8" O.D. Comp.	B	25	25	\$29.58
660-GTRB	5/8" O.D. Female Comp. × 5/8" O.D. Comp.	B	25	25	\$30.20

**HydraRester™**

**MIP**

Item Number	Item Description	Pkg Type	Min Qty	Case Qty	Price
652-A	1/2", Type A, Fixture Units; 1-11	B	1	16	\$22.65
653-B	3/4", Type B, Fixture Units; 12-32	B	1	16	\$26.50
654-C	1", Type C, Fixture Units; 33-60	B	1	16	\$67.07
655-D	1", Type D, Fixture Units; 61-113	B	1	4	\$88.38
656-E	1", Type E, Fixture Units; 114-154	B	1	4	\$116.88
657-F	1", Type F, Fixture Units; 155-330	B	1	4	\$175.47



652-A

**HydraRester™**

**Sweat/Press-Fit**

· Do not overheat. Do not braze.

Item Number	Item Description	Pkg Type	Min Qty	Case Qty	Price
652-AS	1/2", Type A, Fixture Units; 1-11	B	1	16	\$23.30
653-BS	3/4", Type B, Fixture Units; 12-32	B	1	16	\$26.96
654-CS	1", Type C, Fixture Units; 33-60	B	1	16	\$66.55
655-DS	1", Type D, Fixture Units; 61-113	B	1	4	\$88.38
656-ES	1", Type E, Fixture Units; 114-154	B	1	4	\$116.88
657-FS	1", Type F, Fixture Units; 155-330	B	1	4	\$175.47



653-BS

**HydraRester™**

**CPVC**

Item Number	Item Description	Pkg Type	Min Qty	Case Qty	Price
652-AC	1/2", Type A, Fixture Units; 1-11	B	1	16	\$25.64
653-BC	3/4", Type B, Fixture Units; 12-32	B	1	16	\$33.40
654-CC	1", Type C, Fixture Units; 33-60	B	1	16	\$77.58



652-AC

Supply

Drainage

Support

Specialties

Appendix

Supply

Drainage

Support

Specialties

Appendix



652-AX



652-AWG



658-2004



658S2004F2

### HydraRester™

#### PEX

Item Number	Item Description	Pkg Type	Min Qty	Case Qty	Price
<b>F1807 PEX</b>					
652-AX	1/2" F1807, Type A, Fixture Units; 1-11	B	1	16	\$24.87
653-BX	3/4" F1807, Type B, Fixture Units; 12-32	B	1	16	\$28.71
654-CX	1" F1807, Type C, Fixture Units; 33-60	B	1	16	\$67.07
<b>F1960 PEX</b>					
652-AWG	1/2" F1960, Type A, Fixture Units; 1-11	B	1	16	\$27.42
653-BWG	3/4" F1960, Type B, Fixture Units; 12-32	B	1	16	\$36.93
654-CWG	1" F1960, Type C, Fixture Units; 33-60	B	1	16	\$78.79

### MegaRester™

#### Copper

· For industrial Applications. Contact Sioux Chief for custom sizing

Item Number	Item Description	Pkg Type	Min Qty	Case Qty	Price
658-1503	3" MIP, 150 Cu. In.	B	1	1	\$1,559.40
658-2002	2" MIP, 200 Cu. In.	B	1	1	\$1,634.25
658-2004	4" MIP, 200 Cu. In.	B	1	1	\$1,634.25
658-4004	4" MIP, 400 Cu. In.	B	1	1	\$2,107.86
658-4004F2	4" Class 150 Flange, 400 Cu. In.	B	1	1	\$2,195.29

### MegaRester™

#### Stainless Steel

· For industrial Applications. Contact Sioux Chief for custom sizing

Item Number	Item Description	Pkg Type	Min Qty	Case Qty	Price
658S2002	2" MIP, 200 Cu. In.	B	1	1	\$3,679.94
658S2004F2	4" Class 150 Flange, 200 Cu. In.	B	1	1	\$4,353.16
658S4004F2	4" Class 150 Flange, 400 Cu. In.	B	1	1	\$5,300.98



**VacuRester™**

**MIP**

· For use where the piping system is subject to cavitation on the non-pressure side of a quick closing valve

Item Number	Item Description	Pkg Type	Min Qty	Case Qty	Price
652-AD	1/2" MIP	B	1	16	\$26.90
657-FD	1" MIP	B	1	4	\$177.97



652-FD

Supply

Drainage

Support

Specialties

Appendix



# Trap Primers

**Mechanical Primers**

**Splitters**

**Priming Drain Adapters**

**Tailpiece Primers**

**Electronic Primers**



Sioux Chief offers a wide variety of ASSE listed trap primers – mechanical, gravity, and electronic, as well as distributors and other accessories.

All Sioux Chief Trap Primers are ASSE Certified. Mechanical Primers are certified to the ASSE 1018 Standard. Electronic and Tailpiece Primers are Certified to the ASSE 1044 Standard.



---

### Male Sweat Fittings

**PRESS-FIT COMPATIBLE** All Sioux Chief male sweat, preformed copper fittings are compatible with press-fit systems and all push fit systems. Do not use push fittings with nickel-plated stub outs.



### Lead-Free Compliant

**LEAD FREE COMPLIANT** Products made from 'Copper' or 'NL/DZR' material comply with NSF-61 & 372 and with the California No Lead Plumbing Law.

**PrimePerfect™**

**Mechanical Trap Primer Valve**

- DO NOT use thread sealant compound
- For use in accessible locations only

Item Number	Item Description	Pkg Type	Min Qty	Case Qty	Price
695-01	1/2" FIP × 1/2" MIP	BI	1	24	\$87.03



695-01

**Splitter**

**Wye Splitter**

- DO NOT use pipe dope on FIP swivel threads

Item Number	Item Description	Pkg Type	Min Qty	Case Qty	Price
695-Y52	Two 1/2" MIP Branches	BI	1	10	\$49.78



695-Y52

**Splitter**

**Distributor**

- DO NOT use pipe dope on FIP swivel threads

Item Number	Item Description	Pkg Type	Min Qty	Case Qty	Price
695-D20	Two 1/4" MSWT Branches	BI	1	16	\$29.04
695-D30	Three 1/4" MSWT Branches	BI	1	16	\$31.60
695-D40	Four 1/4" MSWT Branches	BI	1	16	\$34.81
695-D432	Two 1/4" MSWT Branches, Two Spun-Closed Branches	BI	1	16	\$34.81
695-D4325	Two 1/2" FSWT Branches, Two Spun-Closed Branches	BI	1	16	\$34.81
695-D432F	Four 1/2" FIP Branches w/ Two Plugs	BI	1	10	\$57.83



695-D432

Supply

Drainage

Support

Specialties

Appendix



695-3A



695-3P



861-TA23



200-092



695-ES05

### Trap Primer Adapter

#### 1/2" FIP Port

Item Number	Item Description	Pkg Type	Min Qty	Case Qty	Price
<b>ABS - SCH. 40 HUB</b>					
695-2A	2" ABS Hub Adapter w/ 1/2" FIP Port	BI	1	10	\$18.80
695-3A	3" ABS Hub Adapter w/ 1/2" FIP Port	B	1	10	\$21.32
695-4A	4" ABS Hub Adapter w/ 1/2" FIP Port	B	1	10	\$25.07
<b>PVC - SCH. 40 HUB</b>					
695-2P	2" PVC Hub Adapter w/ 1/2" FIP Port	BI	1	10	\$18.80
695-3P	3" PVC Hub Adapter w/ 1/2" FIP Port	BI	1	10	\$21.32
695-4P	4" PVC Hub Adapter w/ 1/2" FIP Port	BI	1	10	\$25.07
<b>CAST IRON NO-HUB</b>					
861-TA22	2" No-Hub - 1/2" FIP	B	1	1	\$213.00
861-TA23	3" No-Hub - 1/2" FIP	B	1	1	\$213.00
861-TA24	4" No-Hub - 1/2" FIP	B	1	1	\$213.00

### TrapEase™

#### Trap Primer Tailpiece

Item Number	Item Description	Pkg Type	Min Qty	Case Qty	Price
200-090	1-1/2" × 8" Direct Connect, Unfinished	B	25	25	\$21.54
200-092	1-1/2" × 8" Direct Connect, Chrome	B	25	25	\$25.20
206-096	1-1/2" × 6" Slip-Joint Connect, Chrome	B	25	25	\$31.21
213-090	1-1/4" × 6" Fine Thread, Unfinished	B	25	25	\$22.63
213-092	1-1/4" × 6" Fine Thread, Chrome	B	25	25	\$26.68

### Electronic Trap Primer

#### Surface Mount Box & Panel

- DO NOT use thread sealant compound
- Do NOT disassemble or remove components. Doing so voids the warranty

Item Number	Item Description	Pkg Type	Min Qty	Case Qty	Price
695-ES05	5 Port	BI	1	1	\$1,317.01
695-ES10	10 Port	BI	1	1	\$1,433.57
695-ES15	15 Port	BI	1	1	\$1,550.12
695-ES20	20 Port	BI	1	1	\$1,666.68
695-ES30	30 Port	BI	1	1	\$1,719.09

## Electronic Trap Primer

### Recessed Box

- DO NOT use thread sealant compound
- Do NOT disassemble or remove components. Doing so voids the warranty

Item Number	Item Description	Pkg Type	Min Qty	Case Qty	Price
695-ER05	5 Port	Bl	1	1	\$1,369.46
695-ER10	10 Port	Bl	1	1	\$1,486.00
695-ER15	15 Port	Bl	1	1	\$1,602.54
695-ER20	20 Port	Bl	1	1	\$1,748.25
695-ER30	30 Port	Bl	1	1	\$1,783.17
<b>PANEL</b>					
971-1414	Outside - 15-1/4" x 15-1/4", Inside - 14" x 14", Painted Steel	B	1	1	\$134.87
971-1430	Outside - 15-1/4" x 31-1/4", Inside - 14" x 30", Painted Steel	B	1	1	\$172.46



695-ER10 w/ 971-1414



971-1414

## Electronic Trap Primer

### Single Outlet Primer

- Do NOT disassemble or remove components. Doing so voids the warranty

Item Number	Item Description	Pkg Type	Min Qty	Case Qty	Price
695-ES01	Electronic Trap Primer Surface Mount	Bl	1	1	\$294.88



695-ES01

## TrapShield™

### Trap Seal Protection Device

Item Number	Item Description	Pkg Type	Min Qty	Case Qty	Price
835-2	Trapshield™ For 2" Drain Outlet	Bl	1	50	\$56.31
835-3	Trapshield™ For 3" Drain Outlet	Bl	1	25	\$63.36
835-35	Trapshield™ For 3-1/2" Drain Head	Bl	1	25	\$63.36
835-4	Trapshield™ For 4" Drain Outlet	Bl	1	20	\$74.98



835-2





# **Access**

**Laundry, Appliance,**

**Ice Maker, Kitchen Sink,**

**Water Service Valve - Single/Dual,**

**Pressure-Reducing Valve,**

**Water Heater, Termination Outlet,**

**Water Softener, Gas Service**

**Air Admittance Valve Box**

**Outlet Box Accessories**

**Access Panels**

# Access

## Outlet Boxes, Plates & Panels

Sioux Chief outlet boxes are listed by IAPMO to cUPC and are designed with inlet connections conforming to all appropriate ASTM standards. Water supply valves for potable water service meet ASME A112.18.1 and comply with NSF-61 and *California No Lead Plumbing Law*. Leaded brass options are available for non-potable water applications only.

Water hammer arresters included with applicable models are ASSE certified to the *ANSI/ASSE 1010 Performance Requirements for Water Hammer Arresters*.



Fire-rated models are listed by Warnock Hersey to meet ASTM E-814, CAN/ULC S115  
See product spec sheets for individual product ratings



The resin used in all CPVC connections has been tested, and is monitored on an ongoing basis, to assure its chemical compatibility with FlowGuard Gold®, BlazeMaster® and Corzan® piping systems and products made with TempRite® Technology.

The FBC System Compatible Logo, FBC™, FlowGuard Gold®, BlazeMaster®, Corzan®, and TempRite® are trademarks of Lubrizol Advanced Materials, Inc. or its affiliates.

## Custom Product Available

Sioux Chief offers OxBox™ outlet box options that are NOT listed in this catalog.  
To build your custom product number, use the guide below.

Note: Custom item must be ordered with a minimum qty of 30. Custom items are non-returnable.

### 696 A B C D E F G H

E.g. 696-2313XF = OxBox supply and drain box with two, leaded, 3/4" male hose thread outlet valves with arresters, 1/2" F1807 PEX connection and frame included.

#### **A Special Standards**

- (dash) Standard product<sup>1</sup>
- R Fire-Rated product
- G No-Lead compliant valves<sup>2</sup>
- RG Fire-Rated product with No-Lead compliant valves

#### **B Supply Box Options**

- 1 One-valve box
- 2 Two-valve box
- 3 Three-valve box
- 4 Four-valve box

#### **C Drain Box Options**

- 0 (zero) No drain box
- 3 Drain box included
- 4 Supply box with drain

#### **D Valve & Arrester Options**

- 0 (zero) No Arresters on valves
  - 1 Arresters on valves
  - 2 Integral, secondary stop
- #### **E Outlet Options**
- 0 (zero) 1/4" Compression outlet
  - 1 3/8" Compression outlet
  - 3 3/4" Male hose thread outlet

#### **F Inlet Options**

- C 1/2" Male CPVC
- M 1/2" MIP/FSWT
- P 1/2" MSWT/Press/Push
- V 1/2" F3347 PEX
- W 1/2" F1960 PEX
- X 1/2" F1807 PEX

#### **G Frame Options**

- F Frames included
- R Rough-in Pack - frames not included

#### **H Additional Options** if applicable

- PK4 Display box package

- <sup>1</sup> Leaded brass valves: C37700 or C36000
- <sup>2</sup> No-Lead valves: C69300 dezincification and SCC resistant material. Compliant with NSF-61 Annex G and California No-Lead Plumbing Law

# **3/4" Hose Outlet for Laundry**

**OxBox™**

**OxBox ONE™**

**OmniPanel™**

**ClassicBox™**

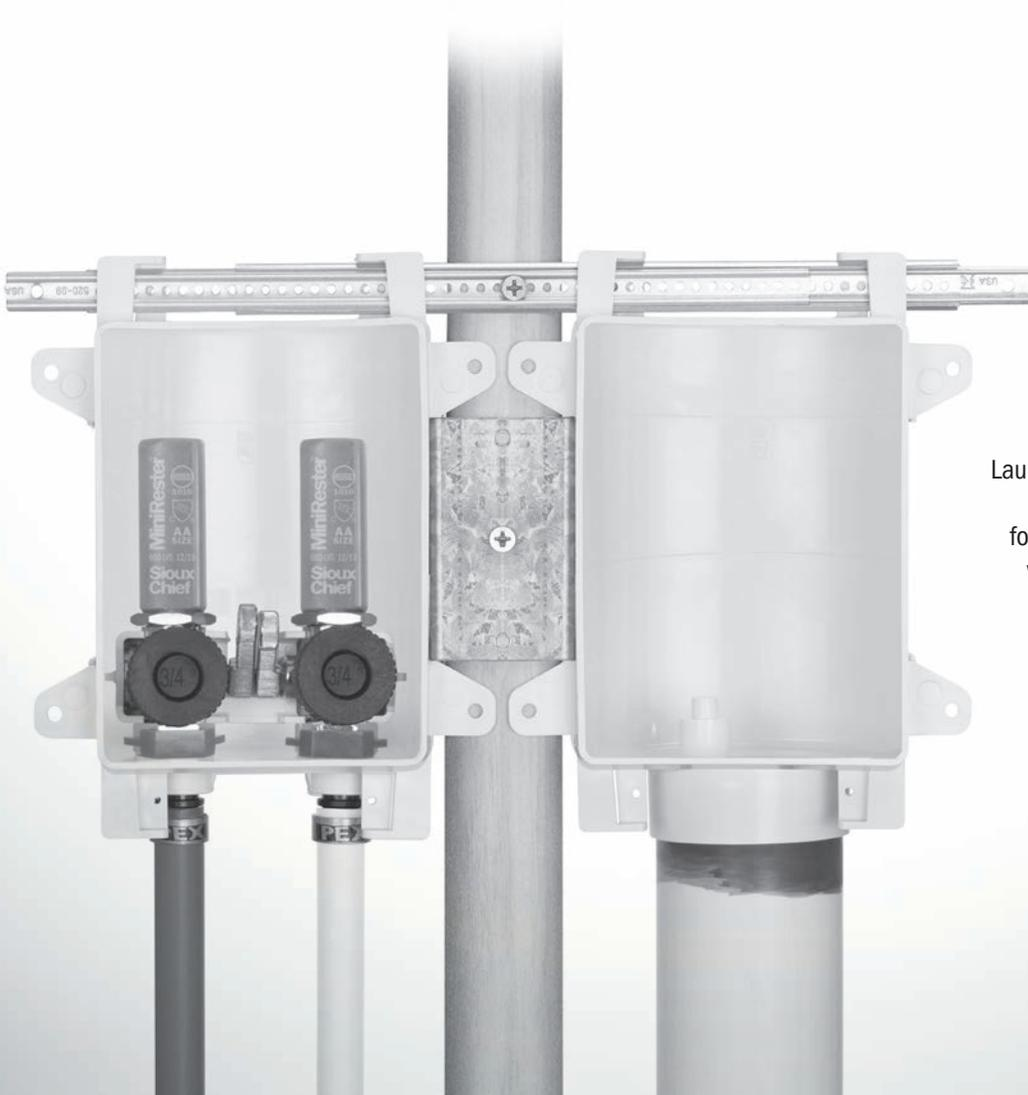

Laundry outlet boxes provide easy access to water supply valves for the washing machine. A wide variety of inlet connections are available for easy hook-up in most supply systems.



**696-G2313MF**  
Page 157



**696-G2303CR**  
Page 158



**696-G2413WF**  
Page 159



**696-G2403MR**  
Page



**698-A33ACR**  
Page 160



**698-A33-CR**  
Page 160



**688-G11WR**  
Page 161



**699-A3-XR**  
Page



**696-G1010WR**  
Page 165



**696RG1000XF**  
Page 166



**699RA0-XR**  
Page



**696-G1001MR**  
Page 169



**699-A1EMR**  
Page 170



**696-G2011XF**  
Page 173



**696-G2001MR**  
Page 173



**698-A11APR**  
Page 174



**698-A11-MR**  
Page 174



**696-G3021WR**  
Page 179



**696-1020GF**  
Page 207



**250-696122P**  
Page 211



**688-G1CE**  
Page 215



**696-3**  
Page 215



**696-2F**  
Page 216



**305-RT**  
Page 217



**970-112**  
Page 221

**OxBox™ 3/4" Outlet**

**Arrester**

Item Number	Item Description	Pkg Type	Min Qty	Case Qty	Price
<b>WITH FRAME</b>					
696-G2313CF	1/2" CPVC Male	BI	10	10	\$73.66
696-G2313MF	1/2" MIP/FSWT	BI	10	10	\$73.66
696-G2313PF	1/2" MSWT/Press/Push	BI	10	10	\$73.66
696-G2313VF	1/2" F3347 PEX	BI	10	10	\$73.66
696-G2313WF	1/2" F1960 PEX	BI	10	10	\$76.66
696-G2313XF	1/2" F1807 PEX	BI	10	10	\$73.66
<b>WITH FRAME - LEADED VALVE</b>					
696-2313CF	1/2" CPVC Male	BI	10	10	\$72.92
696-2313MF	1/2" MIP/FSWT	BI	10	10	\$72.92
696-2313VF	1/2" F3347 PEX Press	BI	10	10	\$72.92
696-2313WF	1/2" F1960 PEX	BI	10	10	\$75.92
696-2313XF	1/2" F1807 PEX	BI	10	10	\$72.92
<b>ROUGH-IN</b>					
696-G2313CR	1/2" CPVC Male	BI	10	10	\$70.26
696-G2313ER	1/2" Everloc+	BI	10	10	\$75.76
696-G2313MR	1/2" MIP/FSWT	BI	10	10	\$70.26
696-G2313PR	1/2" MSWT/Press/Push	BI	10	10	\$70.26
696-G2313VR	1/2" F3347 PEX	BI	10	10	\$70.26
696-G2313WR	1/2" F1960 PEX	BI	10	10	\$73.26
696-G2313XR	1/2" F1807 PEX	BI	10	10	\$70.26
<b>ROUGH-IN - LEADED VALVE</b>					
696-2313CR	1/2" CPVC Male	BI	10	10	\$70.12
696-2313ER	1/2" Everloc+	BI	10	10	\$75.62
696-2313MR	1/2" MIP/FSWT	BI	10	10	\$70.12
696-2313WR	1/2" F1960 PEX	BI	10	10	\$73.12
696-2313XR	1/2" F1807 PEX	BI	10	10	\$70.12
<b>INDIVIDUALLY BAR-CODED IN DISPLAY BOX - LEADED VALVE</b>					
696-2313MFPK4	1/2" MIP/FSWT	BI	4	4	\$79.67



696-G2313MF



696-2313CR

**OxBox™ 3/4" Outlet**

**Non-Arrester**

Item Number	Item Description	Pkg Type	Min Qty	Case Qty	Price
<b>WITH FRAME</b>					
696-G2303CF	1/2" CPVC Male	BI	10	10	\$46.16
696-G2303MF	1/2" MIP/FSWT	BI	10	10	\$46.16
696-G2303PF	1/2" MSWT/Press/Push	BI	10	10	\$46.16
696-G2303VF	1/2" F3347 PEX	BI	10	10	\$46.16
696-G2303WF	1/2" F1960 PEX	BI	10	10	\$49.16
696-G2303XF	1/2" F1807 PEX	BI	10	10	\$46.16



696-G2303MF

Supply

Drainage

Support

Specialties

Appendix



696-G2303CR

### OxBox™ 3/4" Outlet (Cont)

#### Non-Arrester

Item Number	Item Description	Pkg Type	Min Qty	Case Qty	Price
<b>ROUGH-IN</b>					
696-G2303CR	1/2" CPVC Male	BI	10	10	\$42.76
696-G2303ER	1/2" Everloc+	BI	10	10	\$48.26
696-G2303MR	1/2" MIP/FSWT	BI	10	10	\$42.76
696-G2303PR	1/2" MSWT/Press/Push	BI	1	10	\$42.76
696-G2303VR	1/2" F3347 PEX	BI	10	10	\$42.76
696-G2303WR	1/2" F1960 PEX	BI	10	10	\$45.76
696-G2303XR	1/2" F1807 PEX	BI	10	10	\$42.76

### OxBox™ 3/4" Outlet, Fire-Rated

#### Arrester



696RG2313WF

Item Number	Item Description	Pkg Type	Min Qty	Case Qty	Price
<b>WITH FRAME</b>					
696RG2313CF	1/2" CPVC Male	BI	10	10	\$117.88
696RG2313MF	1/2" MIP/FSWT	BI	10	10	\$117.88
<b>696RG2313PF</b>	1/2" MSWT/Press/Push	BI	10	30	\$117.88
696RG2313VF	1/2" F3347 PEX Press	BI	10	10	\$117.88
696RG2313WF	1/2" F1960 PEX	BI	10	10	\$120.88
696RG2313XF	1/2" F1807 PEX	BI	10	10	\$117.88
<b>WITH FRAME - LEADED</b>					
696R2313CF	1/2" CPVC Male	BI	10	10	\$117.14
696R2313MF	1/2" MIP/FSWT	BI	10	10	\$117.14
696R2313VF	1/2" F3347 PEX Press	BI	10	10	\$117.14
696R2313WF	1/2" F1960 PEX	BI	10	10	\$120.14
696R2313XF	1/2" F1807 PEX	BI	10	10	\$117.14

### OxBox™ 3/4" Outlet, Fire-Rated

#### Non-Arrester



696RG2303MF

Item Number	Item Description	Pkg Type	Min Qty	Case Qty	Price
<b>WITH FRAME</b>					
696RG2303CF	1/2" CPVC Male	BI	10	10	\$90.38
696RG2303MF	1/2" MIP/FSWT	BI	10	10	\$90.38
<b>696RG2303VF</b>	1/2" F3347 PEX Press	BI	10	10	\$90.38
696RG2303WF	1/2" F1960 PEX	BI	10	10	\$93.38
696RG2303XF	1/2" F1807 PEX	BI	10	10	\$90.38

**OxBox ONE™ 3/4" Outlet**

**Arrester**

Item Number	Item Description	Pkg Type	Min Qty	Case Qty	Price
<b>WITH FRAME</b>					
696-G2413CF	1/2" CPVC Male	BI	10	30	\$69.16
696-G2413MF	1/2" MIP/FSWT	BI	10	10	\$55.41
696-G2413VF	1/2" F3347	BI	10	10	\$69.16
696-G2413WF	1/2" F1960 PEX	BI	10	10	\$72.16
696-G2413XF	1/2" F1807 PEX	BI	10	10	\$69.16
<b>WITH FRAME - LEADED</b>					
696-2413CF	1/2" CPVC Male	BI	10	10	\$68.42
696-2413MF	1/2" MIP/FSWT	BI	10	10	\$68.42
696-2413WF	1/2" F1960 PEX	BI	10	10	\$71.42
696-2413XF	1/2" F1807 PEX	BI	10	10	\$68.42



696-G2413WF

**OxBox ONE™ 3/4" Outlet**

**Non-Arrester**

Item Number	Item Description	Pkg Type	Min Qty	Case Qty	Price
<b>WITH FRAME</b>					
696-G2403CF	1/2" CPVC Male	BI	10	10	\$41.66
696-G2403MF	1/2" MIP/FSWT	BI	10	10	\$41.66
696-G2403WF	1/2" F1960 PEX	BI	10	10	\$44.66
696-G2403XF	1/2" F1807 PEX	BI	10	10	\$41.66



696-G2403XF

**OxBox ONE™ 3/4" Outlet, Fire-Rated**

**Arrester With Frame**

Item Number	Item Description	Pkg Type	Min Qty	Case Qty	Price
696RG2413WF	1/2" F1960 PEX	BI	10	10	\$116.38



696RG2413WF

**OxBox ONE™ 3/4" Outlet, Fire-Rated**

**Non-Arrester With Frame**

Item Number	Item Description	Pkg Type	Min Qty	Case Qty	Price
696RG2403CF	1/2" CPVC Male	BI	10	10	\$85.88
696RG2403WF	1/2" F1960 PEX	BI	10	10	\$88.88



696RG2403WF

Supply

Drainage

Support

Specialties

Appendix



698-A33ACR

### OmniPanel™ 3/4" Outlet

#### Arrester

Item Number	Item Description	Pkg Type	Min Qty	Case Qty	Price
<b>ROUGH-IN</b>					
698-A33ACR	1/2" CPVC	BI	10	10	\$68.58
698-A33AMR	1/2" MIP/FSWT	BI	10	10	\$68.58
698-A33APR	1/2" MSWT/Press/Push	BI	10	10	\$68.58
698-A33AWR	1/2" F1960 PEX	BI	10	10	\$71.58
698-A33AXR	1/2" F1807 PEX	BI	10	10	\$68.58

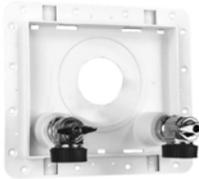

698-A33-CR

### OmniPanel™ 3/4" Outlet

#### Non-Arrester

Item Number	Item Description	Pkg Type	Min Qty	Case Qty	Price
<b>ROUGH-IN</b>					
698-A33-CR	1/2" CPVC	BI	10	10	\$41.08
698-A33-MR	1/2" MIP/FSWT	BI	10	10	\$41.08
698-A33-PR	1/2" MSWT/Press/Push	BI	10	10	\$41.08
698-A33-WR	1/2" F1960 PEX	BI	10	10	\$44.08
698-A33-XR	1/2" F1807 PEX	BI	10	10	\$41.08



698RA33APR

### OmniPanel™ 3/4" Outlet, Fire-Rated

#### Arrester

Item Number	Item Description	Pkg Type	Min Qty	Case Qty	Price
<b>ROUGH-IN</b>					
698RA33ACR	1/2" CPVC	BI	10	10	\$88.26
698RA33AMR	1/2" MIP/FSWT	BI	10	10	\$88.08
698RA33APR	1/2" MSWT/Press/Push	BI	10	10	\$88.08
698RA33AWR	1/2" F1960 PEX	BI	10	10	\$91.08
698RA33AXR	1/2" F1807 PEX	BI	10	10	\$88.08

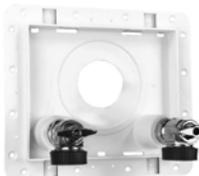

698RA33-XR

### OmniPanel™ 3/4" Outlet, Fire-Rated

#### Non-Arrester

Item Number	Item Description	Pkg Type	Min Qty	Case Qty	Price
<b>ROUGH-IN</b>					
698RA33-CR	1/2" CPVC	BI	10	10	\$60.58
698RA33-MR	1/2" MIP/FSWT	BI	10	10	\$60.58
698RA33-PR	1/2" MSWT/Press/Push	BI	10	10	\$60.58
698RA33-WR	1/2" F1960 PEX	BI	10	10	\$63.58
698RA33-XR	1/2" F1807 PEX	BI	10	10	\$60.58



**ClassicBox™ 3/4" Outlet**

**Rough-In Outlet**

Item Number	Item Description	Pkg Type	Min Qty	Case Qty	Price
<b>ARRESTER</b>					
688-G11CR	1/2" CPVC Male	BI	10	10	\$61.86
688-G11MR	1/2" MIP/FSWT	BI	10	10	\$61.86
688-G11PR	1/2" MSWT/Press/Push	BI	10	10	\$61.86
688-G11VR	1/2" F3347 PEX Press	BI	10	10	\$61.86
688-G11WR	1/2" F1960 PEX	BI	10	10	\$64.86
688-G11XR	1/2" F1807 PEX	BI	10	10	\$61.86
<b>NON-ARRESTER</b>					
688-G10CR	1/2" CPVC Male	BI	10	10	\$36.61
688-G10MR	1/2" MIP/FSWT	BI	10	10	\$36.61
688-G10PR	1/2" MSWT/Press/Push	BI	10	10	\$36.61
688-G10VR	1/2" F3347 PEX Press	BI	10	10	\$36.61
688-G10WR	1/2" F1960 PEX	BI	10	10	\$39.61
688-G10XR	1/2" F1807 PEX	BI	10	10	\$36.61



688-G11WR



688-G10XR

Supply

Drainage

Support

Specialties

Appendix



# 1/4" Outlet for Ice Maker

OxBox™

ProPlate™

Ice maker outlet boxes and plates provide easy access to water supply valves.

Available with water hammer arrester protection and a wide variety of inlet connections are available for easy hook-up in most supply systems.





---

## Male Sweat Fittings

**PRESS-FIT COMPATIBLE** All Sioux Chief male sweat, preformed copper fittings are compatible with press-fit systems and all push fit systems. Do not use push fittings with nickel-plated stub outs.



## Lead-Free Compliant

**LEAD FREE COMPLIANT**

Products made from 'Copper' or 'NL/DZR' material comply with NSF-61 & 372 and with the California No Lead Plumbing Law.

**OxBox™ 1/4" Outlet**

**Arrester**

Item Number	Item Description	Pkg Type	Min Qty	Case Qty	Price
<b>WITH FRAME</b>					
696-G1010CF	1/2" CPVC Male	BI	10	10	\$49.72
696-G1010MF	1/2" MIP/FSWT	BI	10	10	\$49.72
<b>696-G1010PF</b>	1/2" MSWT/Press/Push	BI	10	30	\$49.72
696-G1010VF	1/2" F3347 PEX Press	BI	10	10	\$49.72
696-G1010WF	1/2" F1960 PEX	BI	10	10	\$52.72
696-G1010XF	1/2" F1807 PEX	BI	10	10	\$49.72
<b>ROUGH IN</b>					
696-G1010CR	1/2" CPVC Male	BI	10	10	\$46.92
696-G1010MR	1/2" MIP/FSWT	BI	10	10	\$46.92
696-G1010PR	1/2" MSWT/Press/Push	BI	10	10	\$46.92
696-G1010VR	1/2" F3347 PEX Press	BI	10	10	\$46.92
696-G1010WR	1/2" F1960 PEX	BI	10	10	\$49.92
696-G1010XR	1/2" F1807 PEX	BI	10	10	\$46.92
<b>WITH FRAME &amp; 72" STAINLESS STEEL HOSE</b>					
696-G1010XFS	1/2" F1807 PEX	BI	10	10	\$57.72



696-G1010CF



696-G1010WR



696-G1010XFS

**OxBox™ 1/4" Outlet**

**Non-Arrester**

Item Number	Item Description	Pkg Type	Min Qty	Case Qty	Price
<b>WITH FRAME</b>					
696-G1000CF	1/2" CPVC Male	BI	10	10	\$35.97
696-G1000MF	1/2" MIP/FSWT	BI	10	10	\$35.97
696-G1000PF	1/2" MSWT/Press/Push	BI	10	10	\$35.97
696-G1000VF	1/2" F3347 PEX Press	BI	10	10	\$35.97
696-G1000WF	1/2" F1960 PEX	BI	10	10	\$38.97
696-G1000XF	1/2" F1807 PEX	BI	10	10	\$35.97
<b>ROUGH-IN</b>					
696-G1000CR	1/2" CPVC Male	BI	10	10	\$33.17
696-G1000MR	1/2" MIP/FSWT	BI	10	10	\$33.17
696-G1000WR	1/2" F1960 PEX	BI	10	10	\$36.17
696-G1000XR	1/2" F1807 PEX	BI	10	10	\$33.17
<b>INDIVIDUALLY BAR-CODED IN DISPLAY BOX</b>					
696-G1000MFPK4	1/2" MIP/FSWT	BI	5	5	\$42.72
<b>WITH FRAME &amp; 72" STAINLESS STEEL HOSE</b>					
696-G1000XFS	1/2" F1807 PEX	BI	10	10	\$43.97



696-G1000XF



696-G1000MFPK4

Supply

Drainage

Support

Specialties

Appendix

Supply

Drainage

Support

Specialties

Appendix



696RG1010VF

### OxBox™ 1/4" Outlet, Fire-Rated

#### Arrester

Item Number	Item Description	Pkg Type	Min Qty	Case Qty	Price
<b>WITH FRAME</b>					
696RG1010CF	1/2" CPVC Male	BI	10	10	\$93.94
696RG1010MF	1/2" MIP/FSWT	BI	10	10	\$93.94
696RG1010PF	1/2" MSWT/Press/Push	BI	10	30	\$93.94
696RG1010VF	1/2" F3347 PEX Press	BI	10	10	\$93.94
696RG1010WF	1/2" F1960 PEX	BI	10	10	\$96.94
696RG1010XF	1/2" F1807 PEX	BI	10	10	\$93.94



696RG1000XF

### OxBox™ 1/4" Outlet, Fire-Rated

#### Non-Arrester

Item Number	Item Description	Pkg Type	Min Qty	Case Qty	Price
<b>WITH FRAME</b>					
696RG1000CF	1/2" CPVC Male	BI	10	10	\$80.19
696RG1000MF	1/2" MIP/FSWT	BI	10	10	\$80.19
696RG1000VF	1/2" F3347 PEX Press	BI	10	10	\$80.19
696RG1000WF	1/2" F1960 PEX	BI	10	10	\$83.19
696RG1000XF	1/2" F1807 PEX	BI	10	10	\$80.19



699-A0-XR

### ProPlate™ 1/4" Outlet

#### Rough-In Outlet

Item Number	Item Description	Pkg Type	Min Qty	Case Qty	Price
699-A0-CR	1/2" CPVC	BI	10	10	\$19.54
699-A0-MR	1/2" MIP/FSWT	BI	10	10	\$19.54
699-A0-PR	1/2" MSWT/Press/Push	BI	10	10	\$19.54
<b>699-A0-VR</b>	1/2" F3347 PEX Press	BI	10	30	\$19.54
699-A0-WR	1/2" F1960 PEX	BI	10	10	\$21.04
699-A0-XR	1/2" F1807 PEX	BI	10	10	\$19.54

# Single $\frac{3}{8}$ " Outlet for Lav, Toilet or Dishwasher

**OxBox™**

**ProPlate™**

Outlet boxes and plates provide easy access to  $\frac{3}{8}$ " water supply valves for toilet or dishwasher.

Available with water hammer arrester protection and a wide variety of inlet connections are available for easy hook-up in most supply systems.





---

### Male Sweat Fittings

**PRESS-FIT COMPATIBLE** All Sioux Chief male sweat, preformed copper fittings are compatible with press-fit systems and all push fit systems. Do not use push fittings with nickel-plated stub outs.



### Lead-Free Compliant



Products made from 'Copper' or 'NL/DZR' material comply with NSF-61 & 372 and with the California No Lead Plumbing Law.



**OxBox™ 3/8" Outlet-Single valve**

**Arrester**

Item Number	Item Description	Pkg Type	Min Qty	Case Qty	Price
<b>WITH FRAME</b>					
696-G1011CF	1/2" CPVC Male	BI	10	10	\$49.72
696-G1011MF	1/2" MIP/FSWT	BI	10	10	\$49.72
<b>696-G1011PF</b>	1/2" MSWT/Press/Push	BI	10	30	\$49.72
696-G1011VF	1/2" F3347 PEX Press	BI	10	10	\$49.72
696-G1011WF	1/2" F1960 PEX	BI	10	10	\$52.72
696-G1011XF	1/2" F1807 PEX	BI	10	10	\$49.72



696-G1011XF

**OxBox™ 3/8" Outlet-Single valve**

**Non-Arrester**

Item Number	Item Description	Pkg Type	Min Qty	Case Qty	Price
<b>WITH FRAME</b>					
696-G1001CF	1/2" CPVC Male	BI	10	10	\$35.97
696-G1001MF	1/2" MIP/FSWT	BI	10	10	\$35.97
696-G1001PF	1/2" MSWT/Press/Push	BI	10	10	\$35.97
696-G1001VF	1/2" F3347 PEX Press	BI	10	10	\$35.97
696-G1001WF	1/2" F1960 PEX	BI	10	10	\$38.97
696-G1001XF	1/2" F1807 PEX	BI	10	10	\$35.97
<b>ROUGH-IN</b>					
696-G1001CR	1/2" CPVC Male	BI	10	10	\$33.17
696-G1001MR	1/2" MIP/FSWT	BI	10	10	\$33.17
696-G1001WR	1/2" F1960 PEX	BI	10	10	\$36.17
696-G1001XR	1/2" F1807 PEX	BI	10	10	\$33.17



696-G1001CF



696-G1001MR

**OxBox™ 3/8" Outlet, Fire-Rated - Single Valve**

**Arrester**

Item Number	Item Description	Pkg Type	Min Qty	Case Qty	Price
<b>WITH FRAME</b>					
<b>696RG1011CF</b>	1/2" CPVC Male	BI	10	30	\$93.94
<b>696RG1011MF</b>	1/2" MIP/FSWT	BI	10	30	\$93.94
<b>696RG1011XF</b>	1/2" F1807 PEX	BI	10	30	\$93.94



696RG1011XF

Supply

Drainage

Support

Specialties

Appendix



696RG1001WF

**OxBox™ 3/8" Outlet, Fire-Rated - Single Valve  
Non-Arrester**

Item Number	Item Description	Pkg Type	Min Qty	Case Qty	Price
<b>WITH FRAME</b>					
696RG1001CF	1/2" CPVC Male	BI	10	10	\$80.19
696RG1001MF	1/2" MIP/FSWT	BI	10	10	\$80.19
<b>696RG1001VF</b>	1/2" F3347 PEX Press	BI	10	30	\$80.19
696RG1001WF	1/2" F1960 PEX	BI	10	10	\$83.19
696RG1001XF	1/2" F1807 PEX	BI	10	10	\$80.19



699-A1-XR



699-A1EMR

**ProPlate™ 3/8" Outlet  
Rough-In Outlet**

Item Number	Item Description	Pkg Type	Min Qty	Case Qty	Price
699-A1-CR	1/2" CPVC	BI	10	10	\$19.54
699-A1-MR	1/2" MIP/FSWT	BI	10	10	\$19.54
699-A1-PR	1/2" MSWT/Press/Push	BI	10	10	\$19.54
699-A1-VR	1/2" F3347 PEX Press	BI	10	30	\$19.54
699-A1-WR	1/2" F1960 PEX	BI	10	10	\$21.04
699-A1-XR	1/2" F1807 PEX	BI	10	10	\$19.54
<b>EXTENDED VALVE</b>					
699-A1ECR	1/2" CPVC	BI	10	10	\$24.54
699-A1EMR	1/2" MIP/FSWT	BI	10	10	\$24.54
699-A1EPR	1/2" MSWT/Press/Push	BI	10	10	\$24.54
699-A1EVR	1/2" F3347 PEX Press	BI	10	10	\$24.54
699-A1EWR	1/2" F1960 PEX	BI	10	10	\$26.04
699-A1EXR	1/2" F1807 PEX	BI	10	10	\$24.54

**ProPlate™ 3/8" Outlet  
Fire-Rated Rough-In Outlet**

Item Number	Item Description	Pkg Type	Min Qty	Case Qty	Price
<b>699RA1-MR</b>	1/2" MIP/FSWT	BI	10	30	\$32.74
<b>699RA1-PR</b>	1/2" MSWT/Press/Push	BI	10	30	\$32.74
699RA1-WR	1/2" F1960 PEX	BI	10	10	\$34.24
699RA1-XR	1/2" F1807 PEX	BI	10	10	\$32.74
<b>EXTENDED VALVE</b>					
<b>699RA1EMR</b>	1/2" MIP/FSWT	BI	10	30	\$37.74
<b>699RA1EPR</b>	1/2" MSWT/Press/Push	BI	10	30	\$37.74
699RA1EWR	1/2" F1960 PEX	BI	10	10	\$39.24
699RA1EXR	1/2" F1807 PEX	BI	10	10	\$37.74



699RA1-XR



699RA1EMR

# Dual 3/8" Outlets for Lavatory

OxBox™

OmniPanel™

The OxBox™ outlet box and unique OmniPanel™ valved access plate provide quality, dual 3/8" water supply valves for lavatory applications.

Available with water hammer arrester protection and a wide variety of inlet connections are available for easy hook-up in most supply systems.





### Male Sweat Fittings

**PRESS-FIT  
COMPATIBLE** All Sioux Chief male sweat, preformed copper fittings are compatible with press-fit systems and all push fit systems. Do not use push fittings with nickel-plated stub outs.

### Lead-Free Compliant

**LEAD  
FREE  
COMPLIANT** Products made from 'Copper' or 'NL/DZR' material comply with NSF-61 & 372 and with the California No Lead Plumbing Law.

**OxBox™ 3/8" Outlets - Dual valve**

**Arrester**

Item Number	Item Description	Pkg Type	Min Qty	Case Qty	Price
<b>WITH FRAME</b>					
696-G2011CF	1/2" CPVC Male	BI	10	10	\$72.88
696-G2011MF	1/2" MIP/FSWT	BI	10	10	\$72.88
696-G2011VF	1/2" Viega PEX Press	BI	10	10	\$72.88
696-G2011WF	1/2" F1960 PEX	BI	10	10	\$75.88
696-G2011XF	1/2" F1807 PEX	BI	10	10	\$72.88



696-G2011XF

**OxBox™ 3/8" Outlets - Dual valve**

**Non-Arrester**

Item Number	Item Description	Pkg Type	Min Qty	Case Qty	Price
<b>WITH FRAME</b>					
696-G2001CF	1/2" CPVC Male	BI	10	10	\$45.38
696-G2001MF	1/2" MIP/FSWT	BI	10	10	\$45.38
696-G2001PF	1/2" MSWT/Press/Push	BI	10	10	\$45.38
696-G2001VF	1/2" F3347 PEX Press	BI	10	10	\$45.38
696-G2001WF	1/2" F1960 PEX	BI	10	10	\$48.38
696-G2001XF	1/2" F1807 PEX	BI	10	10	\$45.38
<b>ROUGH-IN</b>					
696-G2001CR	1/2" CPVC Male	BI	10	10	\$41.98
696-G2001MR	1/2" MIP/FSWT	BI	10	10	\$41.98
696-G2001PR	1/2" MSWT/Press/Push	BI	10	10	\$41.98
696-G2001WR	1/2" F1960 PEX	BI	10	10	\$44.98
696-G2001XR	1/2" F1807 PEX	BI	10	10	\$41.98



696-G2001MF



696-G2001MR

**OxBox™ 3/8" Outlets, Fire-Rated - Dual Valve**

**Arrester**

Item Number	Item Description	Pkg Type	Min Qty	Case Qty	Price
<b>WITH FRAME</b>					
696RG2011CF	1/2" CPVC Male	BI	10	30	\$117.10
696RG2011MF	1/2" MIP	BI	10	30	\$117.10
696RG2011VF	1/2" F3347 PEX Press	BI	10	30	\$117.10
696RG2011XF	1/2" F1807 PEX	BI	10	30	\$117.10

Supply

Drainage

Support

Specialties

Appendix



696RG2001XF

### OxBox™ 3/8" Outlets, Fire-Rated - Dual Valve Non-Arrester

Item Number	Item Description	Pkg Type	Min Qty	Case Qty	Price
<b>WITH FRAME</b>					
696RG2001CF	1/2" CPVC Male	BI	10	10	\$89.60
696RG2001MF	1/2" MIP/FSWT	BI	10	10	\$89.60
696RG2001PF	1/2" MSWT/Press/Push	BI	10	10	\$89.60
696RG2001VF	1/2" F3347 PEX Press	BI	10	10	\$89.60
696RG2001WF	1/2" F1960 PEX	BI	10	10	\$92.60
696RG2001XF	1/2" F1807 PEX	BI	10	10	\$89.60



696-T2001XR

### OxBox™ 3/8" Outlets, TMV, Dual Outlet

Item Number	Item Description	Pkg Type	Min Qty	Case Qty	Price
<b>ROUGH-IN</b>					
696-T2001CR	1/2" CPVC Male	BI	1	10	\$156.00
696-T2001PR	1/2" MSWT/Press/Push	BI	1	10	\$156.00
696-T2001WR	1/2" F1960 PEX	BI	1	10	\$156.00
696-T2001XR	1/2" F1807 PEX	BI	1	10	\$156.00
<b>REPAIR KITS</b>					
<b>120-TM3F-1</b>	THERMOSTATIC MIX VLV SCREEN KIT, 2/BG	BI	1	500	\$0.87
120-TM3F-2	THERMOSTATIC MIX VLV PISTON REPAIR KIT, 2/BG	BI	1	300	\$14.65
120-TM3F-3	THERMOSTATIC MIX VLV CHECK VALVE REPAIR KIT, 2/BG	BI	1	500	\$4.39

### OmniPanel™ 3/8" Outlets

#### Arrester



698-A11APR

Item Number	Item Description	Pkg Type	Min Qty	Case Qty	Price
<b>ROUGH-IN</b>					
698-A11APR	1/2" MSWT/Press/Push	BI	10	10	\$68.58
698-A11AWR	1/2" F1960 PEX	BI	10	10	\$71.58
698-A11AXR	1/2" F1807 PEX	BI	10	10	\$68.58

### OmniPanel™ 3/8" Outlets

#### Non-Arrester



698-A11-MR

Item Number	Item Description	Pkg Type	Min Qty	Case Qty	Price
<b>ROUGH-IN</b>					
698-A11-MR	1/2" MIP/FSWT	BI	10	10	\$41.08
698-A11-PR	1/2" MSWT/Press/Push	BI	10	10	\$41.08
<b>698-A11-VR</b>	1/2" F3347 PEX Press	BI	10	10	\$41.08
698-A11-WR	1/2" F1960 PEX	BI	10	10	\$44.08
698-A11-XR	1/2" F1807 PEX	BI	10	10	\$41.08

### OmniPanel™ 3/8" Outlets, Fire-Rated

#### Arrester

Item Number	Item Description	Pkg Type	Min Qty	Case Qty	Price
<b>ROUGH-IN</b>					
698RA11APR	1/2" MSWT/Press/Push	BI	10	10	\$88.08
698RA11AWR	1/2" F1960 PEX	BI	10	10	\$91.08
698RA11AXR	1/2" F1807 PEX	BI	10	10	\$88.08



698RA11AWR

### OmniPanel™ 3/8" Outlets, Fire-Rated

#### Non-Arrester

Item Number	Item Description	Pkg Type	Min Qty	Case Qty	Price
<b>ROUGH-IN</b>					
698RA11-CR	1/2" CPVC	BI	10	10	\$60.58
698RA11-MR	1/2" MIP/FSWT	BI	10	10	\$60.58
698RA11-PR	1/2" MSWT/Press/Push	BI	10	10	\$60.58
698RA11-VR	1/2" F3347 PEX Press	BI	10	10	\$60.58
698RA11-WR	1/2" F1960 PEX	BI	10	10	\$63.58
698RA11-XR	1/2" F1807 PEX	BI	10	10	\$60.58



698RA11-PR

Supply

Drainage

Support

Specialties

Appendix





# Multiple Outlets for Kitchen Sink

OxBox™

The OxBox™ outlet box provides multiple combinations of 3/8" (sink/dishwasher) and 1/4" (ice maker) water supply valves for almost any kitchen water supply application.

Available with water hammer arrester protection and a wide variety of inlet connections are available for easy hook-up in most supply systems.

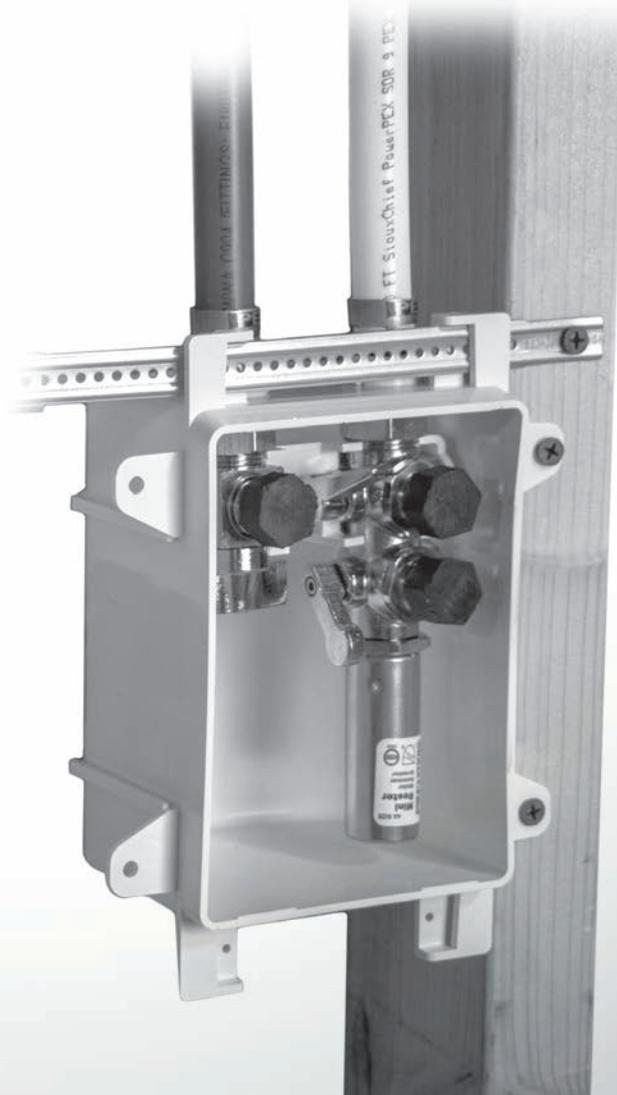



### Male Sweat Fittings

**PRESS-FIT COMPATIBLE** All Sioux Chief male sweat, preformed copper fittings are compatible with press-fit systems and all push fit systems. Do not use push fittings with nickel-plated stub outs.



### Lead-Free Compliant

**LEAD FREE COMPLIANT** Products made from 'Copper' or 'NL/DZR' material comply with NSF-61 & 372 and with the California No Lead Plumbing Law.

**OxBox™ 3/8" Outlets, Multi-Valve**

**3 Valve Rough-In Outlet**

Item Number	Item Description	Pkg Type	Min Qty	Case Qty	Price
<b>THREE 3/8" OUTLETS WITH HOT-SIDE ARRESTER</b>					
696-G3011CR	1/2" CPVC Male - 2 × Hot, 1 × Cold	BI	10	10	\$73.33
696-G3011MR	1/2" FSWT / MIP - 2 × Hot, 1 × Cold	BI	10	10	\$73.33
696-G3011PR	1/2" MSWT / Press / Push - 2 × Hot, 1 × Cold	BI	10	30	\$73.33
696-G3011VR	1/2" F3347 PEX Press - 2 × Hot, 1 × Cold	BI	10	30	\$73.33
696-G3011WR	1/2" F1960 PEX - 2 × Hot, 1 × Cold	BI	10	10	\$76.33
696-G3011XR	1/2" F1807 PEX - 2 × Hot, 1 × Cold	BI	10	10	\$73.33
<b>TWO 3/8" &amp; ONE 1/4" OUTLET WITH COLD-SIDE ARRESTER</b>					
696-G3014CR	1/2" Male CPVC - 1 X 3/8 Hot, 1 X 3/8 Cold, 1 X 1/4 Cold	BI	10	30	\$73.33
696-G3014MR	1/2" FSWT / MIP - 1 X 3/8 Hot, 1 X 3/8 Cold, 1 X 1/4 Cold	BI	10	30	\$73.33
696-G3014PR	1/2" MSWT / Press / Push - 1 X 3/8 Hot, 1 X 3/8 Cold, 1 X 1/4 Cold	BI	10	30	\$73.33
696-G3014WR	1/2" F1960 PEX - 1 X 3/8 Hot, 1 X 3/8 Cold, 1 X 1/4 Cold	BI	10	30	\$76.33
696-G3014XR	1/2" F1807 PEX - 1 X 3/8 Hot, 1 X 3/8 Cold, 1 X 1/4 Cold	BI	10	30	\$73.33
<b>THREE 3/8" OUTLETS WITH DUAL ARRESTERS</b>					
696-G3021CR	1/2" Male CPVC - 2 X Hot, 1 X Cold	BI	10	30	\$87.08
696-G3021MR	1/2" FSWT / MIP - 2 X Hot, 1 X Cold	BI	10	30	\$87.08
696-G3021WR	1/2" F1960 PEX - 2 × Hot, 1 × Cold	BI	10	10	\$90.08
696-G3021XR	1/2" F1807 PEX - 2 × Hot, 1 × Cold	BI	10	30	\$87.08
<b>TWO 3/8" &amp; ONE 1/4" OUTLET WITH DUAL ARRESTERS</b>					
696-G3024CR	1/2" Male CPVC - 1 × 3/8 Hot, 1 × 3/8 Cold, 1/4 Cold	BI	10	30	\$87.08
696-G3024MR	1/2" FSWT / MIP - 1 × 3/8 Hot, 1 × 3/8 Cold, 1/4 Cold	BI	10	30	\$87.08
696-G3024WR	1/2" F1960 PEX - 1 × 3/8 Hot, 1 × 3/8 Cold, 1/4 Cold	BI	10	30	\$90.08
696-G3024XR	1/2" F1807 PEX - 1 × 3/8 Hot, 1 × 3/8 Cold, 1/4 Cold	BI	10	30	\$87.08



696-G3011WR



696-G3021WR



696-G3024WR

**OxBox™ 3/8" Outlets, Multi-Valve**

**4 Valve Rough-In Outlet**

Item Number	Item Description	Pkg Type	Min Qty	Case Qty	Price
<b>FOUR 3/8" OUTLETS WITH DUAL ARRESTERS</b>					
696-G4021CR	1/2" Male CPVC - 2 × Hot, 2 × Cold	BI	10	10	\$104.08
696-G4021MR	1/2" FSWT / MIP - 2 × Hot, 2 × Cold	BI	10	30	\$104.08
696-G4021PR	1/2" MSWT / Press / Push - 2 × Hot, 2 × Cold	BI	10	30	\$104.08
696-G4021WR	1/2" F1960 PEX - 2 × Hot, 2 × Cold	BI	10	30	\$107.08
696-G4021XR	1/2" F1807 PEX - 2 × Hot, 2 × Cold	BI	10	30	\$104.08



696-G4021WR

Supply

Drainage

Support

Specialties

Appendix



### OxBox™ 3/8" Outlets, Multi-Valve (Cont)

#### 4 Valve Rough-In Outlet

Item Number	Item Description	Pkg Type	Min Qty	Case Qty	Price
<b>THREE 3/8" &amp; ONE 1/4" OUTLET WITH DUAL ARRESTERS</b>					
696-G4024CR	1/2" Male CPVC - 2 × 3/8 Hot, 1 × 3/8 Cold, 1 × 1/4 Cold	BI	10	10	\$104.08
696-G4024MR	1/2" FSWT / MIP - 2 × 3/8 Hot, 1 × 3/8 Cold, 1 × 1/4 Cold	BI	10	30	\$104.08
696-G4024PR	1/2" MSWT / Press / Push - 2 × 3/8 Hot, 1 × 3/8 Cold, 1 × 1/4 Cold	BI	10	30	\$104.08
696-G4024WR	1/2" F1960 PEX - 2 × 3/8 Hot, 1 × 3/8 Cold, 1 × 1/4 Cold	BI	10	30	\$107.08
696-G4024XR	1/2" F1807 PEX - 2 × 3/8 Hot, 1 × 3/8 Cold, 1 × 1/4 Cold	BI	10	30	\$104.08



### OxBox™ 3/8" Outlets, Multi-Valve

#### 3 Valve With Frame Fire-Rated Outlet

Item Number	Item Description	Pkg Type	Min Qty	Case Qty	Price
<b>THREE 3/8" OUTLETS WITH HOT-SIDE ARRESTER</b>					
696RG3011PF	1/2" MSWT / Press / Push - 2 × Hot, 1 × Cold	BI	10	10	\$120.35
696RG3011VF	1/2" F3347 PEX Press - 2 × Hot, 1 × Cold	BI	10	10	\$120.35
696RG3011WF	1/2" F1960 PEX - 2 × Hot, 1 × Cold	BI	10	10	\$123.35
696RG3011XF	1/2" F1807 PEX - 2 × Hot, 1 × Cold	BI	10	10	\$120.35
<b>THREE 3/8" OUTLETS WITH DUAL ARRESTERS</b>					
696RG3021WF	1/2" F1960 PEX - 2 × Hot, 1 × Cold	BI	10	30	\$137.10

### OxBox™ 3/8" Outlets, Multi-Valve

#### 4 Valve With Frame Fire-Rated Outlet

Item Number	Item Description	Pkg Type	Min Qty	Case Qty	Price
<b>FOUR 3/8" OUTLETS WITH DUAL ARRESTERS</b>					
696RG4021MF	1/2" FSWT / MIP - 2 × Hot, 2 × Cold	BI	10	30	\$151.10
696RG4021WF	1/2" F1960 PEX - 2 X Hot, 2 X Cold	BI	10	30	\$154.10
<b>THREE 3/8" &amp; ONE 1/4" OUTLET WITH DUAL ARRESTERS</b>					
696RG4024XF	1/2" F1807 PEX - 2 × 3/8 Hot, 1 × 3/8 Cold, 1 × 1/4 Cold	BI	10	10	\$151.10

# Water Service: Single-Valve

ServiceBox™



The water service single-valve box is perfect for use as a main shut-off for the dwelling, or install it anywhere a single, accessible valve is needed in the system.

Capped outlet port behind handle makes it easy to drain-down the system when valve is shut off.

Every ServiceBox™ is approved for fire-rated applications. They can be installed in shared or rated walls with no need to fire-caulk or box around with drywall

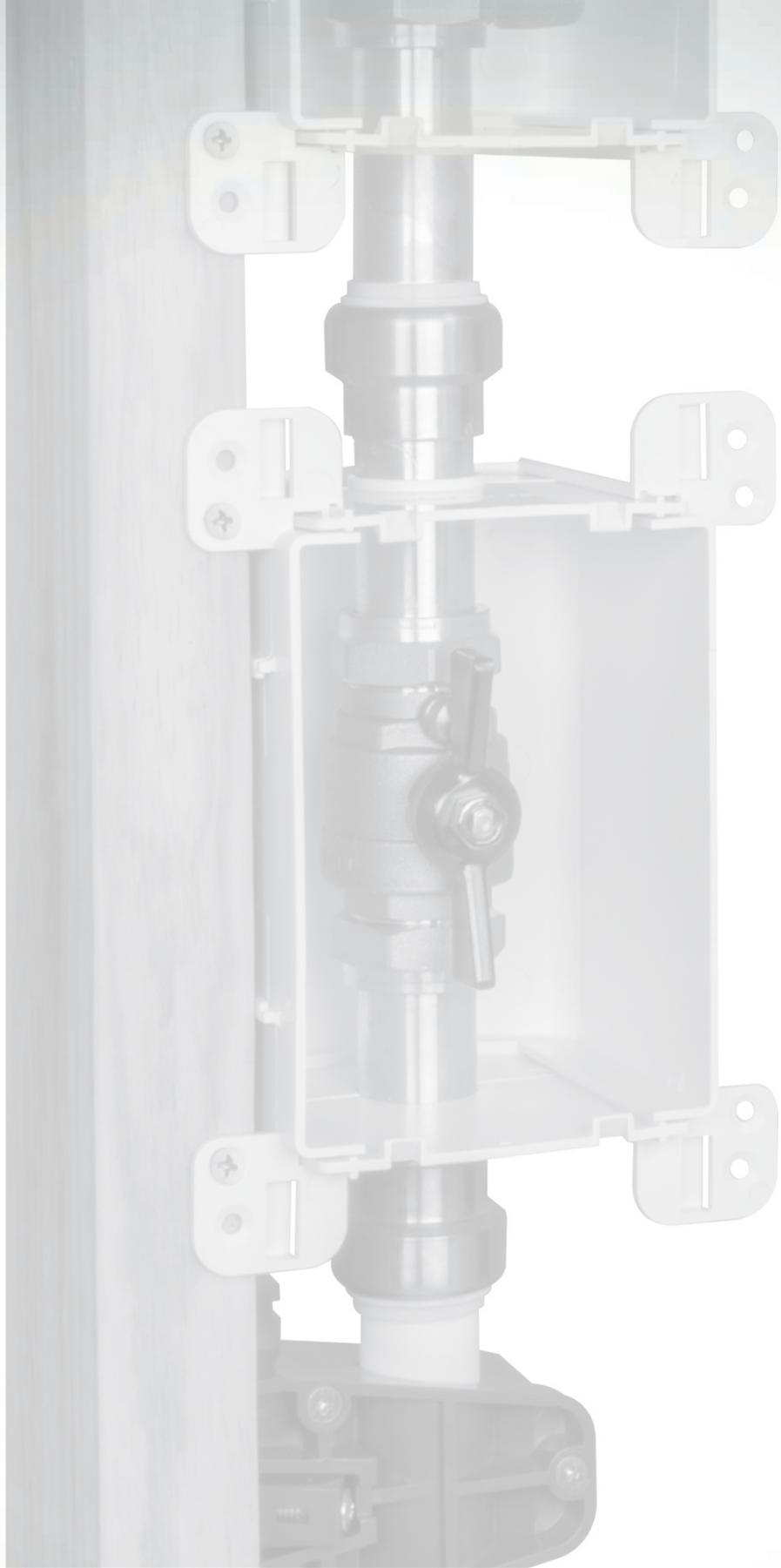

---

### Male Sweat Fittings

**PRESS-FIT  
COMPATIBLE** All Sioux Chief male sweat, preformed copper fittings are compatible with press-fit systems and all push fit systems. Do not use push fittings with nickel-plated stub outs.



### Lead-Free Compliant

**LEAD  
FREE  
COMPLIANT** Products made from 'Copper' or 'NL/DZR' material comply with NSF-61 & 372 and with the California No Lead Plumbing Law.

**ServiceBox™ - Single Valve**

**Full-Port Valve With Drain**

Item Number	Item Description	Pkg Type	Min Qty	Case Qty	Price
<b>CPVC</b>					
687-2CD	1/2" CPVC Socket X 1/2" CPVC Socket	BI	1	9	\$64.30
687-3CD	3/4" CPVC Socket X 3/4" CPVC Socket	BI	1	9	\$82.30
687-4CD	1" CPVC Socket X 1" CPVC Socket	BI	1	9	\$103.30
687-5CD	1-1/4" CPVC Socket X 1-1/4" CPVC Socket	BI	1	9	\$146.30
<b>MALE SWEAT - PUSH / PRESS COMPATIBLE</b>					
687-2PD	1/2" MSWT/Press/Push x 1/2" MSWT/Press/Push	BI	1	9	\$56.30
687-3PD	3/4" MSWT/Press/Push x 3/4" MSWT/Press/Push	BI	1	9	\$74.30
687-4PD	1" MSWT/Press/Push x 1" MSWT/Press/Push	BI	1	9	\$95.30
687-5PD	1-1/4" MSWT/Press/Push x 1-1/4" MSWT/Press/Push	BI	1	9	\$138.30
<b>PDQ™ PUSH FIT</b>					
687-2QD	1/2" Push (CTS) Socket X 1/2" Push (CTS) Socket	BI	1	9	\$76.30
687-3QD	3/4" Push (CTS) Socket X 3/4" Push (CTS) Socket	BI	1	9	\$94.30
687-4QD	1" Push (CTS) Socket x 1" Push (CTS) Socket	BI	1	9	\$115.30
687-5QD	1-1/4" Push (CTS) Socket X 1-1/4" Push (CTS) Socket	BI	1	9	\$158.30
<b>F1960</b>					
687-2WD	1/2" PEX F1960 x 1/2" PEX F1960	BI	1	9	\$56.30
687-3WD	3/4" PEX F1960 X 3/4" PEX F1960	BI	1	9	\$74.30
687-4WD	1" PEX F1960 X 1" PEX F1960	BI	1	9	\$95.30
687-5WD	1-1/4" PEX F1960 X 1-1/4" PEX F1960	BI	1	9	\$138.30
<b>F1807</b>					
687-2XD	1/2" PEX F1807 X 1/2" PEX F1807	BI	1	9	\$56.30
687-3XD	3/4" PEX F1807 X 3/4" PEX F1807	BI	1	9	\$74.30
687-4XD	1" PEX F1807 X 1" PEX F1807	BI	1	9	\$95.30
687-5XD	1-1/4" PEX F1807 X 1-1/4" PEX F1807	BI	1	9	\$138.30
<b>IPS PUSH FITTING x CTS PUSH FITTING</b>					
687-3SQD	3/4" Push (IPS) Socket X 3/4" Push (CTS) Socket	BI	1	9	\$84.30
687-4SQD	1" Push (IPS) Socket X 1" Push (CTS) Socket	BI	1	9	\$105.30
<b>CPVC INLET x F1960 OUTLET</b>					
687-3CWD	3/4" CPVC Socket X 3/4" PEX F1960	BI	1	9	\$78.30
687-4CWD	1" CPVC Socket X 1" PEX F1960	BI	1	9	\$99.30
<b>CPVC INLET x F1807 OUTLET</b>					
687-3CXD	3/4" CPVC Socket X 3/4" PEX F1807	BI	1	9	\$78.30
687-4CXD	1" CPVC Socket X 1" PEX F1807	BI	1	9	\$99.30



687-4QD



687-3XD



687-3CWD

Supply

Drainage

Support

Specialties

Appendix





# Water Service: Dual-Valve

ServiceBox™

The dual-valve ServiceBox™ works well as a secondary shut-off for hot/cold mains, remote bathrooms or for separating lines using a wye splitter.

Anodized aluminum T-handles are easy to operate and corrosion-resistant

Every ServiceBox™ is approved for fire-rated applications. They can be installed in shared or rated walls with no need to fire-caulk or box around with drywall

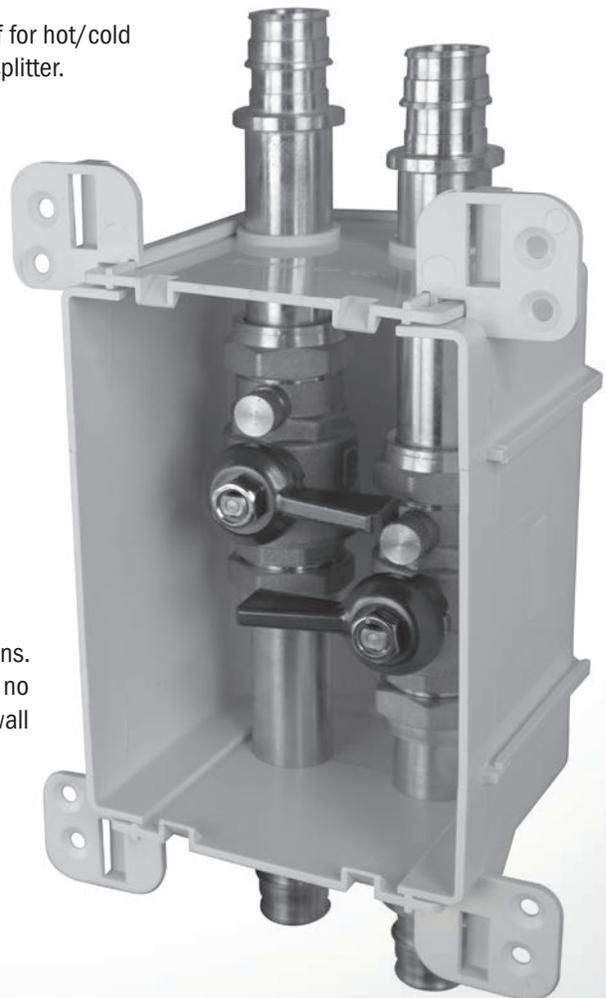

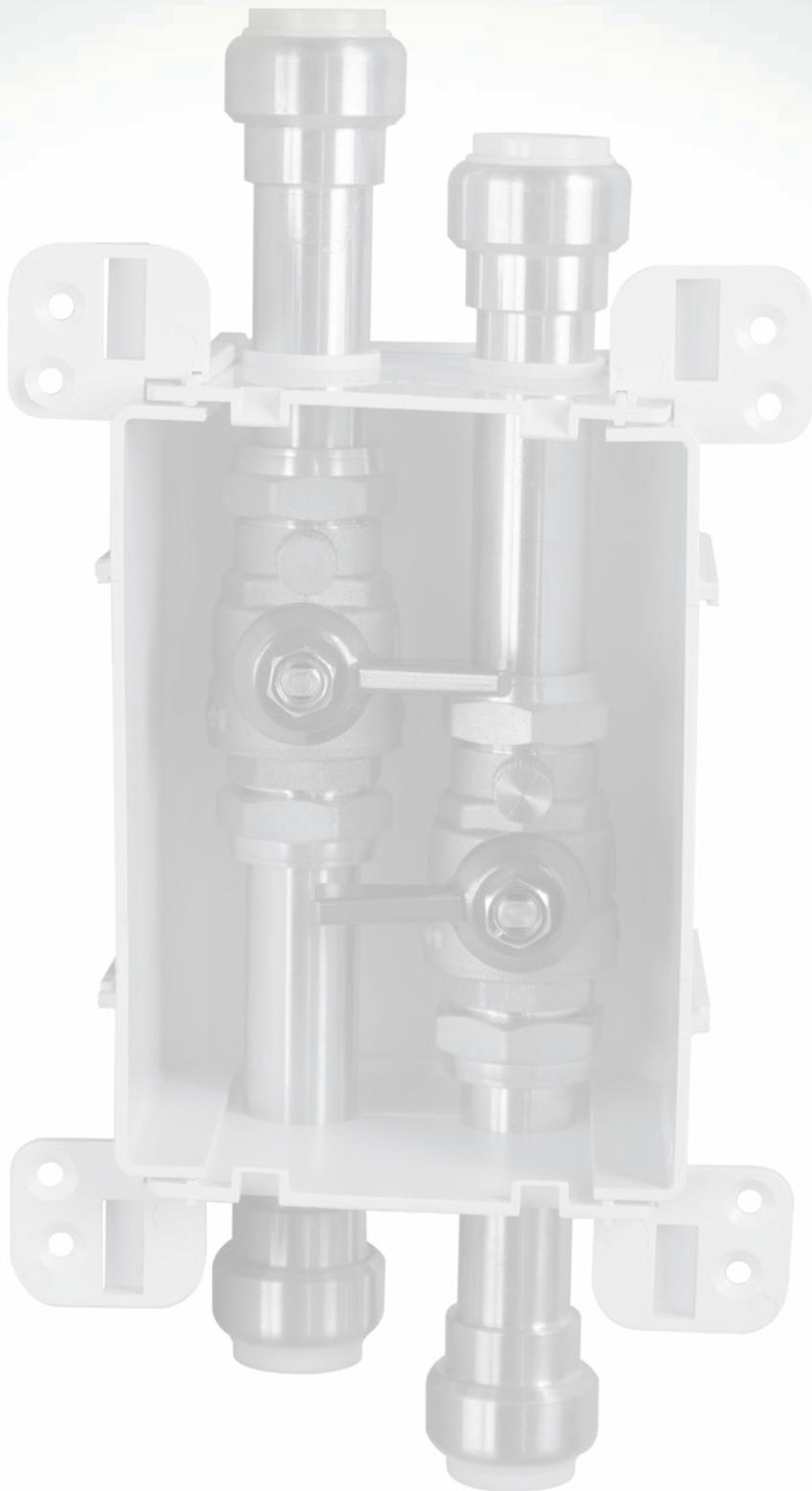

---

### Male Sweat Fittings

**PRESS-FIT  
COMPATIBLE** All Sioux Chief male sweat, preformed copper fittings are compatible with press-fit systems and all push fit systems. Do not use push fittings with nickel-plated stub outs.



### Lead-Free Compliant

**LEAD  
FREE  
COMPLIANT**

Products made from 'Copper' or 'NL/DZR' material comply with NSF-61 & 372 and with the California No Lead Plumbing Law.

**ServiceBox™ - Dual Valve**

**Full-Port Valves With Drain**

Item Number	Item Description	Pkg Type	Min Qty	Case Qty	Price
<b>PDQ™ PUSH FIT</b>					
687-2QDT	1/2" Push (CTS) Socket X 1/2" Push (CTS) Socket	BI	1	9	\$134.30
687-3QDT	3/4" Push (CTS) Socket X 3/4" Push (CTS) Socket	BI	1	9	\$170.30
<b>F1960</b>					
687-2WDT	1/2" PEX F1960 X 1/2" PEX F1960	BI	1	9	\$94.30
687-3WDT	3/4" PEX F1960 X 3/4" PEX F1960	BI	1	9	\$130.30
<b>F1807</b>					
687-2XDT	1/2" PEX F1807 X 1/2" PEX F1807	BI	1	9	\$94.30
687-3XDT	3/4" PEX F1807 X 3/4" PEX F1807	BI	1	9	\$130.30



687-3QDT



687-3XDT

Supply

Drainage

Support

Specialties

Appendix



# Pressure Reducing Valve

**ServiceBox™**



The ServiceBox™ with pressure-reducing valve is typically installed downstream of the main shut-off and helps protect fixtures from excessive pressures coming in from the water service.

Optional capped outlet port is perfect for installing accessories like a ball valve for hose connection, or an adapter for hooking up a pressure gauge.

Every ServiceBox™ is approved for fire-rated applications. They can be installed in shared or rated walls with no need to fire-caulk or box around with drywall



---

### Male Sweat Fittings

**PRESS-FIT COMPATIBLE** All Sioux Chief male sweat, preformed copper fittings are compatible with press-fit systems and all push fit systems. Do not use push fittings with nickel-plated stub outs.



### Lead-Free Compliant

**LEAD FREE COMPLIANT**

Products made from 'Copper' or 'NL/DZR' material comply with NSF-61 & 372 and with the California No Lead Plumbing Law.

## ServiceBox™ - Pressure Reducing Valve

### with Drain

Item Number	Item Description	Pkg Type	Min Qty	Case Qty	Price
<b>MALE SWEAT - PUSH / PRESS COMPATIBLE × PDQ™ PUSH FIT</b>					
687-3RPQD	3/4" MSWT/Press/Push × 3/4" Push (CTS) Socket - with Port	BI	1	9	\$146.30
687-4RPQD	1" MSWT/Press/Push × 1" Push (CTS) Socket - with Port	BI	1	9	\$179.30
<b>PDQ™ PUSH FIT × PDQ™ PUSH FIT</b>					
687-3RQQD	3/4" Push (CTS) Socket x 3/4" Push (CTS) Socket - with Port	BI	1	9	\$164.30
687-4RQQD	1" Push (CTS) Socket X 1" Push (CTS) Socket - with Port	BI	1	9	\$197.30
<b>F1960 × F1960</b>					
687-3RWWD	3/4" PEX F1960 X 3/4" PEX F1960 - with Port	BI	1	9	\$144.30
687-4RWWD	1" PEX F1960 X 1" PEX F1960 - with Port	BI	1	9	\$177.30
<b>F1807 × F1807</b>					
687-3RXXD	3/4" PEX F1807 X 3/4" PEX F1807 - with Port	BI	1	9	\$144.30
687-4RXXD	1" PEX F1807 X 1" PEX F1807 - with Port	BI	1	9	\$177.30



687-4RPQD



687-3RWWD

## ServiceBox™ - Pressure Reducing Valve

### Less Drain

Item Number	Item Description	Pkg Type	Min Qty	Case Qty	Price
<b>MALE SWEAT/PRESS/PUSH COMPATIBLE × PDQ™ PUSH FIT</b>					
687-3RPQ	3/4" MSWT/Press/Push × 3/4" Push (CTS) Socket	BI	1	9	\$143.30
687-4RPQ	1" MSWT/Press/Push × 1" Push (CTS) Socket	BI	1	9	\$176.30
<b>PDQ™ PUSH FIT × PDQ™ PUSH FIT</b>					
687-3RQQ	3/4" Push (CTS) Socket X 3/4" Push (CTS) Socket	BI	1	9	\$161.30
687-4RQQ	1" Push (CTS) Socket X 1" Push (CTS) Socket	BI	1	9	\$194.30
<b>F1960 × F1960</b>					
687-3RWW	3/4" PEX F1960 X 3/4" PEX F1960	BI	1	9	\$141.30
687-4RWW	1" PEX F1960 X 1" PEX F1960	BI	1	9	\$174.30
<b>F1807 × F1807</b>					
687-3RXX	3/4" PEX F1807 X 3/4" PEX F1807	BI	1	9	\$141.30
687-4RXX	1" PEX F1807 X 1" PEX F1807	BI	1	9	\$174.30



687-4RQQ



687-3RXX

Supply

Drainage

Support

Specialties

Appendix





# Water Heater Outlet

ServiceBox™

Two types of water heater access boxes are available, depending on the application, and preferred installation method. The 'Flow-Through' model includes a bypass on the cold outlet (behind the valve), and the 'Termination' model includes a single, valved, cold-side elbow outlet, and a single hot-side elbow inlet.

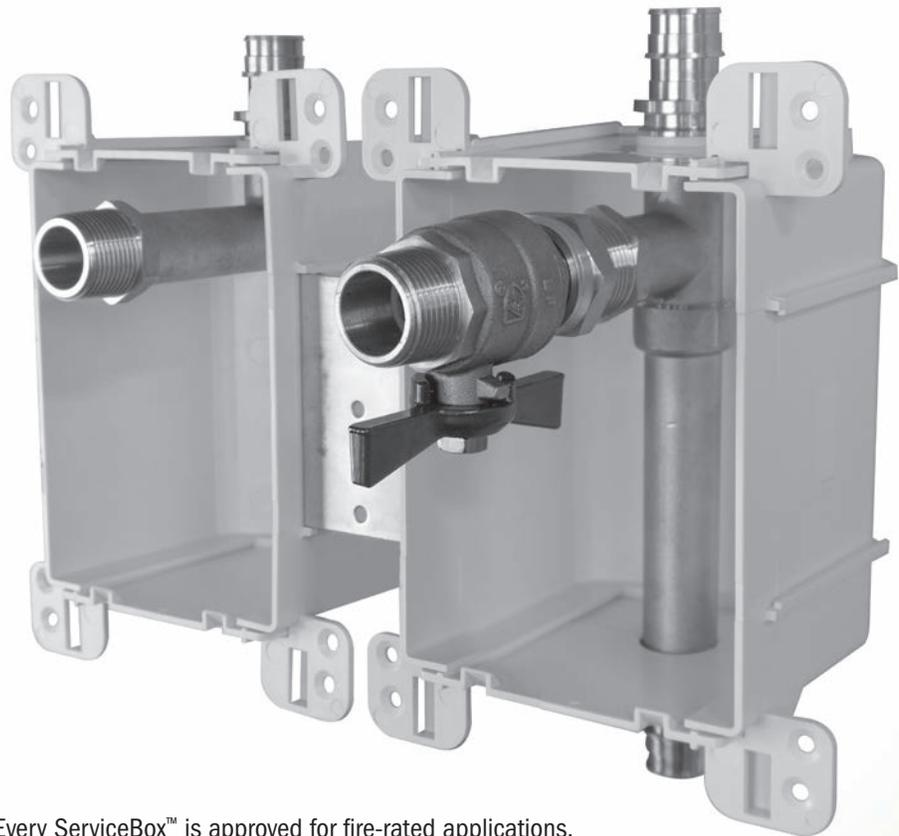

Every ServiceBox™ is approved for fire-rated applications.  
They can be installed in shared or rated walls with no  
need to fire-caulk or box around with drywall



---

### Male Sweat Fittings

**PRESS-FIT COMPATIBLE** All Sioux Chief male sweat, preformed copper fittings are compatible with press-fit systems and all push fit systems. Do not use push fittings with nickel-plated stub outs.



### Lead-Free Compliant



Products made from 'Copper' or 'NL/DZR' material comply with NSF-61 & 372 and with the California No Lead Plumbing Law.

**ServiceBox™ - Water Heater**

**Flow-Thru with Cold-Side valve**

Item Number	Item Description	Pkg Type	Min Qty	Case Qty	Price
<b>MALE SWEAT - PUSH / PRESS COMPATIBLE</b>					
687-3PH	3/4" MSWT/Press/Push	BI	1	6	\$121.30
<b>PDQ™ PUSH FIT</b>					
687-3QH	3/4" Push (CTS) Socket	BI	1	6	\$145.30
<b>F1960</b>					
687-3WH	3/4" PEX F1960	BI	1	6	\$121.30
<b>F1807</b>					
687-3XH	3/4" PEX F1807	BI	1	6	\$121.30
<b>CPVC</b>					
687-3CH	3/4" CPVC Socket	BI	1	6	\$145.30



687-3PH



687-3CH

**ServiceBox™ - Water Heater**

**Termination with Cold-Side valve**

Item Number	Item Description	Pkg Type	Min Qty	Case Qty	Price
<b>MALE SWEAT - PUSH / PRESS COMPATIBLE</b>					
687-3PH2	3/4" MSWT/Press/Push	BI	1	6	\$119.30
<b>PDQ™ PUSH FIT</b>					
687-3QH2	3/4" Push (CTS) Socket	BI	1	6	\$143.30
<b>F1960</b>					
687-3WH2	3/4" PEX F1960	BI	1	6	\$119.30
<b>F1807</b>					
687-3XH2	3/4" PEX F1807	BI	1	6	\$119.30
<b>CPVC</b>					
687-3CH2	3/4" CPVC Socket	BI	1	6	\$143.30



687-3QH2



687-3XH2

Supply

Drainage

Support

Specialties

Appendix



# Termination Outlet

ServiceBox™



The water service termination outlet is perfect for any application where you need valved water service - in the garage/barn/shed, or for connecting an appliance.

Every ServiceBox™ is approved for fire-rated applications. They can be installed in shared or rated walls with no need to fire-caulk or box around with drywall

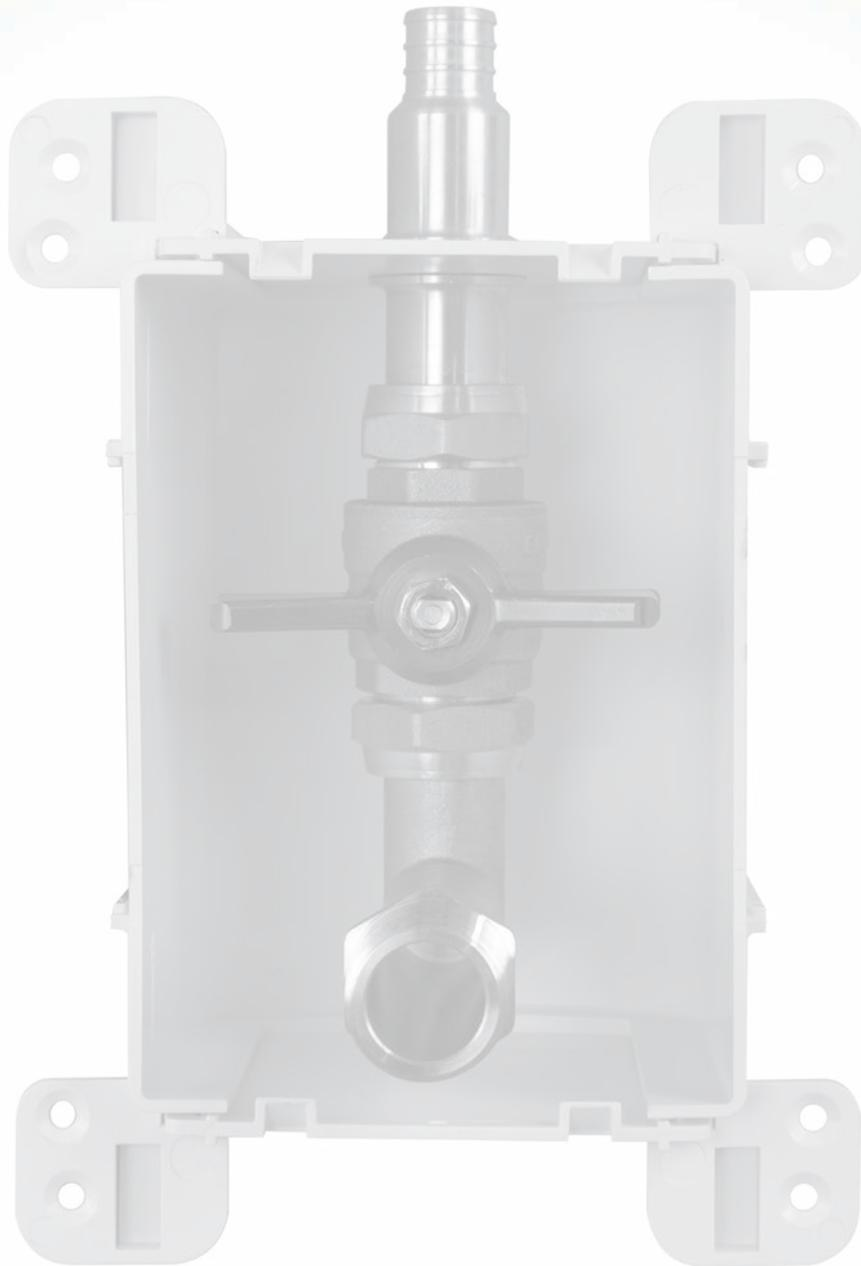

---

### Male Sweat Fittings

**PRESS-FIT COMPATIBLE** All Sioux Chief male sweat, preformed copper fittings are compatible with press-fit systems and all push fit systems. Do not use push fittings with nickel-plated stub outs.



### Lead-Free Compliant



Products made from 'Copper' or 'NL/DZR' material comply with NSF-61 & 372 and with the California No Lead Plumbing Law.

## ServiceBox™ - Single Valve Termination Outlet

### Full-Port Valve with MIP Outlet

Item Number	Item Description	Pkg Type	Min Qty	Case Qty	Price
<b>CPVC</b>					
687-3CV	3/4" CPVC Socket x 3/4" MIP Outlet	BI	8	8	\$74.30
<b>MALE SWEAT - PUSH / PRESS COMPATIBLE</b>					
687-3PV	3/4" MSWT/Press/Push x 3/4" MIP Outlet	BI	8	8	\$70.30
<b>PDQ™ PUSH FIT</b>					
687-3QV	3/4" Push (CTS) x 3/4" MIP Outlet	BI	8	8	\$80.30
<b>F1960</b>					
687-3WV	3/4" PEX F1960 x 3/4" MIP Outlet	BI	8	8	\$70.30
<b>F1807</b>					
687-3XV	3/4" PEX F1807 x 3/4" MIP Outlet	BI	8	8	\$70.30



687-3CV



687-3PV

Supply

Drainage

Support

Specialties

Appendix





# Water Softener Outlet

ServiceBox™

Replace costly, site-fabricated assemblies and loops with a single, easy-to-install product. Provides Hard-Water-In, Soft-Water-Out, and brine discharge connections for water softener hookup in a clean, compact access box.

Optional 3/4" or 1" MIP thread outlets provide ample flow to and from the unit. Outlets are capped and ready for pressure test

Every ServiceBox™ is approved for fire-rated applications. They can be installed in shared or rated walls with no need to fire-caulk or box around with drywall



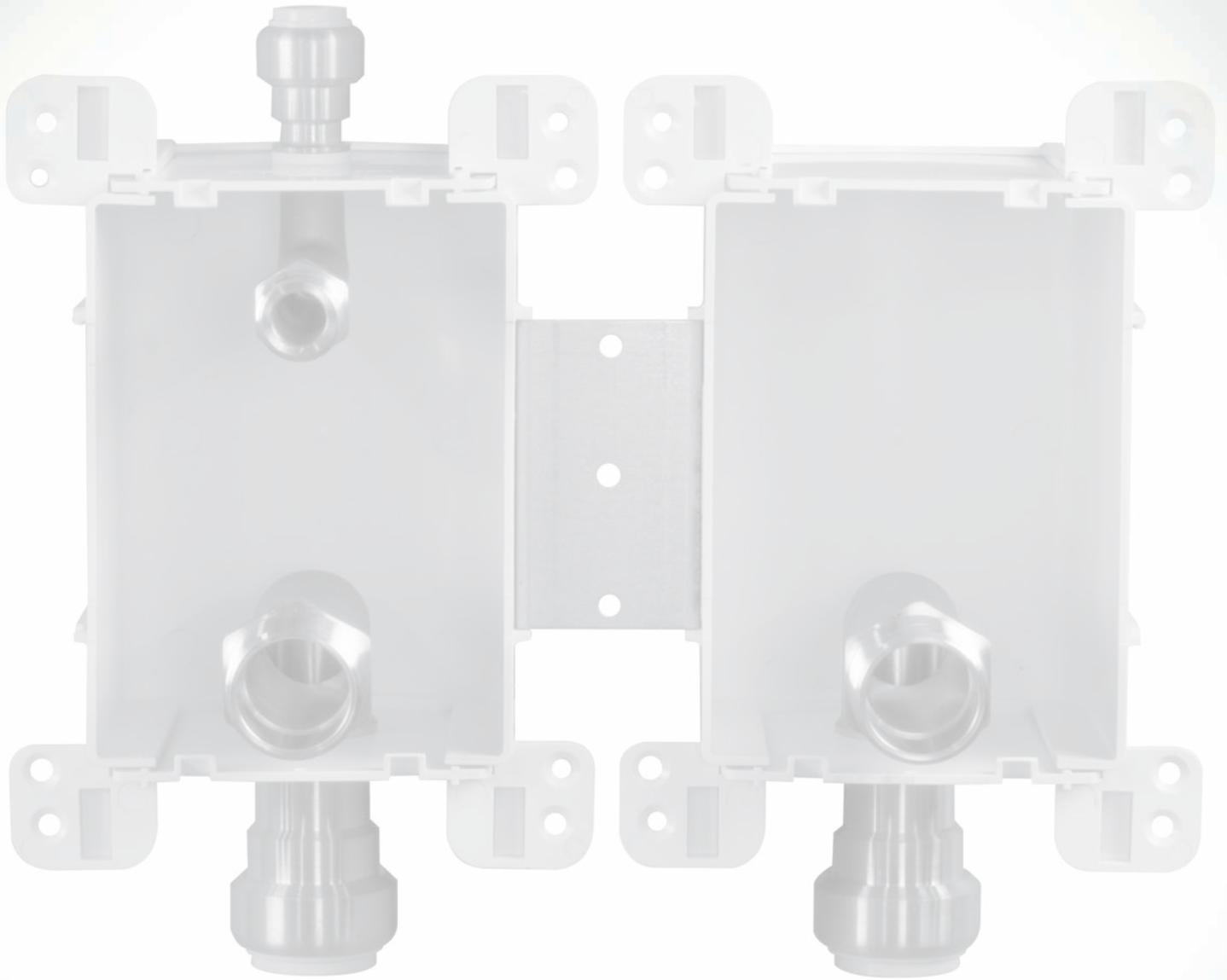

---

### Male Sweat Fittings

**PRESS-FIT  
COMPATIBLE** All Sioux Chief male sweat, preformed copper fittings are compatible with press-fit systems and all push fit systems. Do not use push fittings with nickel-plated stub outs.



### Lead-Free Compliant



Products made from 'Copper' or 'NL/DZR' material comply with NSF-61 & 372 and with the California No Lead Plumbing Law.

## ServiceBox™ - Water Softener Outlet

with MIP Connections

Item Number	Item Description	Pkg Type	Min Qty	Case Qty	Price
<b>CPVC</b>					
687-332CB	3/4" CPVC Socket (2) w/ 1/2" CPVC Socket (1)	BI	8	8	\$102.30
<b>MIP</b>					
687-332MB	3/4" MIP/F.SWT (2) w/ 1/2" MIP/F.SWT (1)	BI	8	8	\$102.30
<b>PDQ™ PUSH FIT</b>					
687-332QB	3/4" Push (CTS) Socket (2) w/ 1/2" Push (CTS) Socket	BI	8	8	\$100.30
687-442QB	1" Push (CTS) Socket (2) w/ 1/2" Push (CTS) Socket (1)	BI	6	6	\$145.30
<b>F1960</b>					
687-332WB	3/4" F1960 (2) w/ 1/2" F1960 (1)	BI	8	8	\$82.30
687-442WB	1" F1960 (2) w/ 1/2" F1960 (1)	BI	6	6	\$127.30
<b>F1807</b>					
687-332XB	3/4" F1807 (2) w/ 1/2" F1807 (1)	BI	8	8	\$84.30
687-442XB	1" F1807 (2) w/ 1/2" F1807 (1)	BI	6	6	\$127.30



687-442QB



687-332XB

Supply

Drainage

Support

Specialties

Appendix



# Gas Service

OxBox™



Gas service outlet boxes provide easy access to shut-off valves for stoves, clothes dryers, or any gas appliance.



**OxBox™ Gas**

**Outlet Box**

· CSST box requires box adapter from CSST manufacturer

Item Number	Item Description	Pkg Type	Min Qty	Case Qty	Price
<b>WITH FRAME - LEADED</b>					
696-1020GF	1/2" FIP Valve For CSST Connection, Bagged	BI	6	6	\$36.50
696-1021GF	1/2" NPT Valve And Adapter For Iron Pipe, Bagged	BI	6	6	\$36.50
696-1031GF	3/4" NPT Valve And Adapter For Iron Pipe, Bagged	BI	6	6	\$37.65



696-1020GF

**OxBox™ Gas**

**Fire-Rated Outlet Box**

· CSST box requires box adapter from CSST manufacturer

Item Number	Item Description	Pkg Type	Min Qty	Case Qty	Price
<b>WITH FRAME - LEADED</b>					
696R1020GF	1/2" FIP Valve For CSST Connection, Bagged	BI	10	10	\$80.72
696R1021GF	1/2" NPT Valve And Adapter For Iron Pipe, Bagged	BI	10	10	\$80.72
696R1031GF	3/4" NPT Valve And Adapter For Iron Pipe, Bagged	BI	10	10	\$80.72



696R1021GF

Supply

Drainage

Support

Specialties

Appendix





# Air Admittance Valve Box

OxBox™

Access boxes are typically required when installing air admittance valves in a stud wall. The OxBox™ provides necessary air flow to the valve and allows for inspection, maintenance or replacement of the valve.

For a less obtrusive look, paintable frames and louvered covers help fixtures blend with wall colors.

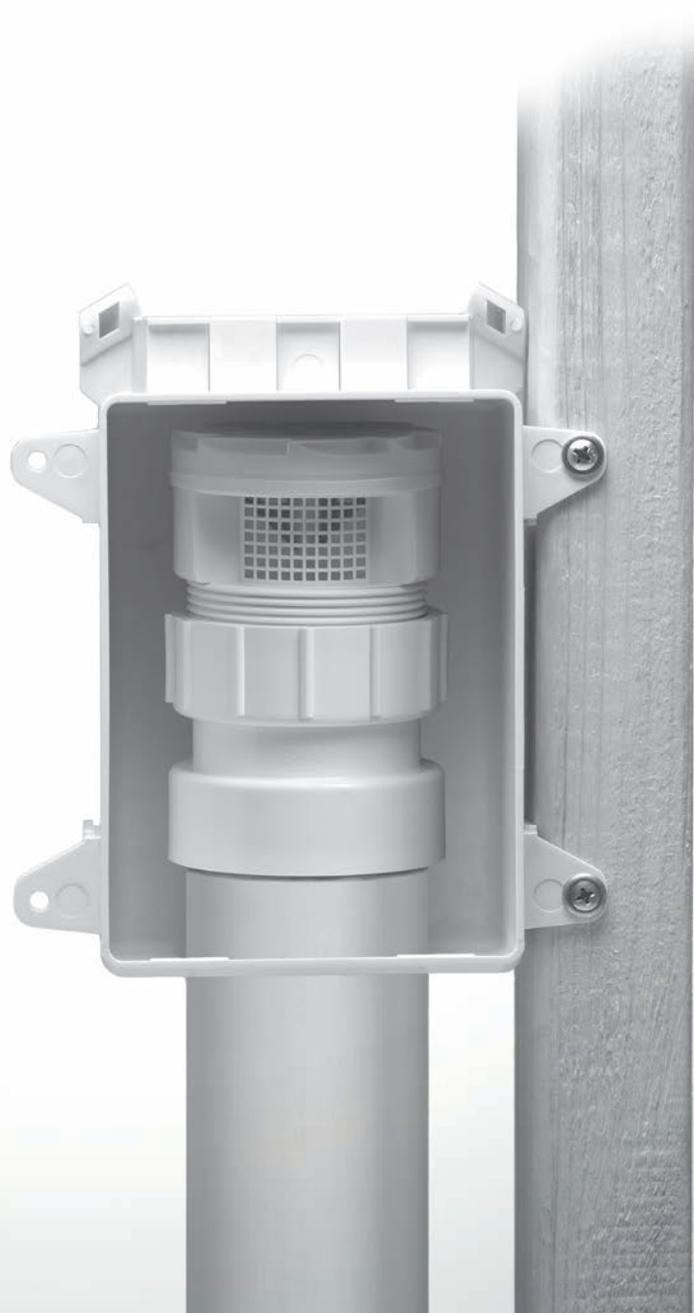



**OxBox™ Turbovent™**

Item Number	Item Description	Pkg Type	Min Qty	Case Qty	Price
<b>PVC CONNECTION - WITH FRAME</b>					
250-696122P	TurboVent™ AAV w/ 1-1/2" - 2" Dual Fit Adapter & OxBox™ Kit	Bl	6	6	\$34.11
696-11P	TurboVent™ AAV w/ 1-1/2" Hub Adapter & OxBox™ Kit	Bl	6	6	\$35.65
696-12P	TurboVent™ AAV w/ 2" Hub Adapter & OxBox™ Kit	Bl	6	6	\$36.65
<b>ABS CONNECTION - WITH FRAME</b>					
250-696122A	TurboVent™ AAV w/ 1-1/2" - 2" Dual Fit Adapter	Bl	6	6	\$34.11
696-11A	TurboVent™ AAV w/ 1-1/2" Hub Adapter & OxBox™ Kit	Bl	1	6	\$35.65
696-12A	TurboVent™ AAV w/ 2" Hub Adapter & OxBox™ Kit	Bl	1	6	\$36.65



250-696122P



696-11A

**OxBox™ Turbovent™**

**Fire-Rated Outlet**

Item Number	Item Description	Pkg Type	Min Qty	Case Qty	Price
<b>PVC CONNECTION - WITH FRAME</b>					
250-696R122P	TurboVent™ AAV w/ 1-1/2" - 2" Dual Fit Adapter & Fire Rated OxBox™ Kit	Bl	1	6	\$86.74
<b>ABS CONNECTION - WITH FRAME</b>					
250-696R122A	TurboVent™ AAV w/ 1-1/2" - 2" Dual Fit Adapter	Bl	1	6	\$86.74



250-696R122P



250-696R122A

Supply

Drainage

Support

Specialties

Appendix



# Outlet Box Accessories

**Valves**

**Boxes**

**Debris Covers**

**Frames & Extensions**

**Box Clips, Brackets & Supports**

**Secondary Drainage Funnel**

**Clips, Nuts & Caps**





Valves

Extension Valves

Item Number	Item Description	Pkg Type	Min Qty	Case Qty	Price
<b>NL/DZR BRASS</b>					
688-G1CE	Extended Replacement Valve - 5/8" OD Comp. Thread x 3/8" OD Comp. Outlet	BI	10	10	\$9.87



688-G1CE

Boxes

Item Number	Item Description	Pkg Type	Min Qty	Case Qty	Price
<b>OXBOX™</b>					
696-1	One-Hole Supply Box	B	10	10	\$5.91
696-2	Two-Hole Supply Box	B	10	10	\$5.91
696-3	Drain Box	B	10	10	\$5.91
696-3F	Drain Box w/ Single Frame	B	10	10	\$8.21
696-4	One-Hole Supply Box/Gas	B	10	10	\$5.91
696-5	1-5/16" One-Hole Supply Box For Large Shank Valves	B	10	10	\$5.91
696-6	1-1/2" One-Hole Box For DWV Pipe	B	10	10	\$5.91
696-7	OxBox – Single Box w/ Hole For 2" Sch. 40 Pipe	B	10	10	\$5.91
696R3	Drain Box w/ Fire Pad And Frame	BI	10	10	\$50.13
<b>CLASSICBOX™</b>					
688-1	ClassicBox™ Box Only	B	10	10	\$9.36



696-3



688-1

Debris Covers

Item Number	Item Description	Pkg Type	Min Qty	Case Qty	Price
<b>PROPLATE™</b>					
699-DC	Debris Cover For ProPlate™	B	10	10	\$1.42
<b>OMNIPANEL™</b>					
698-DC	Debris Cover For OmniPanel™	B	24	24	\$2.90



699-DC



698-DC

Supply

Drainage

Support

Specialties

Appendix

Supply

Drainage

Support

Specialties

Appendix



696-2F

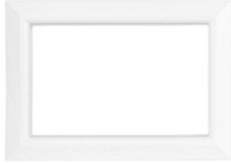

688-F



699-FC



696-C3



696-BC



520-09



696-CF

## Frames, Inserts, & Extensions

Item Number	Item Description	Pkg Type	Min Qty	Case Qty	Price
<b>OXBOX™</b>					
696-1F	Single Frame For OxBox™	B	10	10	\$2.30
696-2F	Double Frame For OxBox™	B	10	10	\$2.90
696-EX	Frame Extension	B	10	10	\$3.84
696-LC	Louvered Frame Insert	B	10	10	\$4.73
696-SC	Solid Frame Insert	B	10	10	\$4.73
696-SC1	Solid Frame Insert w/ Valve Cutout	B	10	10	\$4.73
697-1FL	Ss Locking Door w/ Frame	B	10	10	\$20.30
<b>SERVICEBOX™</b>					
687-1F	Single Frame For ServiceBox™ - Fire Rated	B	10	10	\$5.00
<b>CLASSICBOX™</b>					
688-F	ClassicBox™ Plastic Box Frame	B	10	10	\$2.30
<b>PROPLATE™</b>					
699-FC	Chrome-Plated Escutcheon For ProPlate™ - Fire-Rated ABS, 1/Bag	BI	10	200	\$7.28
699RF	White Escutcheon For ProPlate™ - Paintable, Fire-Rated ABS	B	10	10	\$2.07
<b>OMNIPANEL™</b>					
698-EX	OmniPanel™ Frame Extension	B	10	10	\$3.44
698-F	OmniPanel™ Frame	B	10	10	\$2.90
698RF	Finish Kit - Includes Fire-Rated Frame, Hole-Insert Strips, And Frame Extension	BI	10	10	\$12.05

## Box Clips, Brackets & Supports

Item Number	Item Description	Pkg Type	Min Qty	Case Qty	Price
<b>NYLON CAPS</b>					
688-C0B	1/4" Nylon Comp. Thread Cap, 10/Bag	BI	1	10	\$5.56
688-C1B	3/8" Nylon Comp. Thread Cap, 25/Bag	BI	1	4	\$6.67
<b>CAPS - LEADED</b>					
696-C3	3/4" Brass Hose Thread Cap, 2/Bag	BI	10	10	\$4.96
<b>NUTS</b>					
696-PN	1/2" Plastic Shank Nut	B	50	50	\$0.36
<b>CLIPS</b>					
696-BC	Box Clip	B	10	10	\$2.96
698-VC	Valve Clip Blue/Red, 1/Bag	B	50	50	\$1.04
<b>SUPPORT BRACKET</b>					
520-09	Sliding Support Bracket	B	250	250	\$2.22

## Secondary Drainage Funnel

Item Number	Item Description	Pkg Type	Min Qty	Case Qty	Price
696-CF	Secondary Drainage Funnel	BI	10	10	\$7.69



Access Tools

Item Number	Item Description	Pkg Type	Min Qty	Case Qty	Price
305-RT	Valve Grommet Removal Tool For Access Products	Bl	1	10	\$6.54



305-RT

Supply

Drainage

Support

Specialties

Appendix



# Panels

**Plastic - One-Piece**

**Plastic - Two-Piece**

**OverUnder™**

**Metal - Two-Piece**

One and two piece panels provide inconspicuous access to valves and other plumbing fixtures inside wall cavities.

The unique OverUnder™ panel can be installed during rough-in, or retrofit anytime after drywall installation.

Plastic panels can be painted or wall-papered to match wall finish.

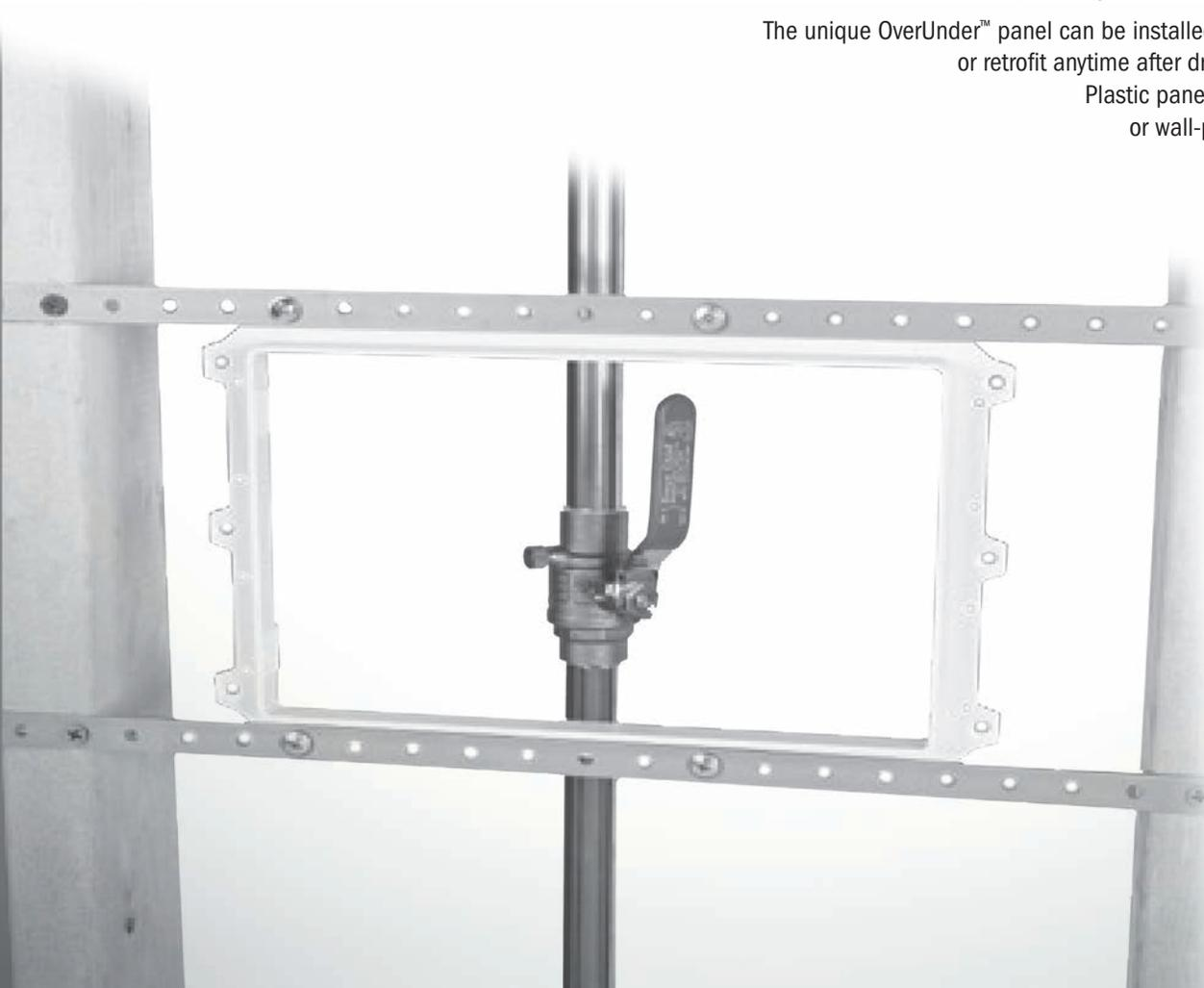



**Plastic Access Panel****One-Piece**

Item Number	Item Description	Pkg Type	Min Qty	Case Qty	Price
970-112	12" × 12", White ABS	BI	20	20	\$9.24
970-117	17" × 17", Polystyrene	BI	12	12	\$17.95



970-112

**Plastic Access Panel****Two-Piece**

Item Number	Item Description	Pkg Type	Min Qty	Case Qty	Price
970-208	Outside - 10-1/4" × 10-1/4", Inside - 8" × 8", White ABS	BI	1	12	\$34.29
970-214	Outside - 17" × 17", Inside - 14" × 14", White ABS	BI	1	12	\$40.81

**OverUnder™ Access Panel****Two-Piece**

Item Number	Item Description	Pkg Type	Min Qty	Case Qty	Price
970-214S	Outside - 16-1/2" × 16-1/2", Inside - 14" × 14", Polystyrene	BI	1	6	\$36.65
970-269S	Outside - 8-1/2" × 11-1/2", Inside - 6" × 9", Polystyrene	BI	1	6	\$30.14



970-214S

**Metal Access Panel****Two-Piece**

Item Number	Item Description	Pkg Type	Min Qty	Case Qty	Price
<b>HINGED</b>					
971-1414	Outside - 15-1/4" × 15-1/4", Inside - 14" × 14", Painted Steel	B	1	1	\$134.87
971-1430	Outside - 15-1/4" × 31-1/4", Inside - 14" × 30", Painted Steel	B	1	1	\$172.46
<b>NON-HINGED</b>					
<b>971-77</b>	7" × 7", Metal	B	1	8	\$800.00
971-99	9" × 9", Metal	B	1	8	\$1,200.00



971-1414



971-99

Supply

Drainage

Support

Specialties

Appendix



# **RoughUp<sup>TM</sup> Kits**

**ShowerUp<sup>TM</sup> Kits**

**HeatUp<sup>TM</sup> Kits**

# RoughUp™ Kits - Featuring Preformed Copper

## Features & Benefits

**Reduces Cost.** Preformed fittings combine multiple products into one solution. These products reduce labor and material investments to save the plumber money and time.

**Expedites Bidding.** Preformed copper items transition a contractor's variable costs into a fixed cost. Estimating jobs is easier due to better materials management and controlled waste.

**Simplifies Stocking.** Preformed copper combines multiple items into single products. Kits are treated as single SKUs for more efficient inventory management. Grab one SKU and go.

**Reduces Noise.** Increased radius bends on preformed products improve the flow characteristics of the application over traditional products. Preformed copper tub drops eliminate 'water stacking' in showers. The larger radius also reduces the noise produced by typical installations.

**Quality Engineering.** Sioux Chief preformed copper fitting ends are engineered and made in the USA, using precision manufacturing techniques. All fitting bends and ends are made to appropriate ASTM standards, compliant to nationally recognized plumbing codes and guaranteed with one of the industry's leading limited lifetime warranties.

**Standardized Layouts.** Reduce the guesswork. Each job, each unit has consistent, repeatable looks, time, materials, and quality.

**Quality Materials.** Sioux Chief utilizes only the best partners, who deliver the highest grades of material to manufacture preformed copper components. Copper is naturally lead-free, dezincification resistant, cost effective, and antimicrobial. It provides the perfect code-compliant solution for any plumbing transition, fitting, or wall termination..

**Variety.** Sioux Chief has countless preformed copper and fitting capabilities. These capabilities offer endless options and solutions.

**Reduces Risk.** Preformed copper reduces fittings for fewer joints. Fewer joints reduce the chances for leaks and reduces liability. Eliminating solder joints can mean removing the torch from the job site. Cheapest insurance there is. Peace-of-Mind

**Professional-Looking.** Preformed product can be used to improve the look of a job and become a "calling card" to help plumbers win bids.

### Male Sweat Fittings



All Sioux Chief male sweat fittings are compatible with press-fit systems and all push fit systems. Do not use push fittings with nickel-plated stub outs.

### Lead-Free Compliant



Products indicated as Lead-Free comply with NSF-61 & 372 and with the California No Lead Plumbing Law.

### FGG/BM/CZ Compatible



All CPVC connections have been tested to assure chemical compatibility with FlowGuard Gold®, BlazeMaster®, and Corzan® pipe and fittings.

\*Are registered trademarks of Lubrizol Corporation.



# Custom ShowerUp™ Kits

Build-Your-Own Kit

Use the following steps to build a kit, using the codes from the following pages

## 1. Start with the ShowerUp™ kit prefix:

Kit Prefix: 693

## 2. Choose a kit code for each component:

- A Tub Spout Elbow
- B Supply Connectors
- C Shower Riser
- D Brackets

## 3. Use this format to build your kit:

Kit Prefix	A Tub Spout Elbow	B Supply Connectors	C Shower Riser	D Bracket Option
693-	00	00	00	00

## 4. Example Item Creation:

Kit Components	Kit Prefix	A Tub Spout Elbow	B Supply Connectors	C Shower Riser	D Bracket Option
Kit Code	693-	13	03	23	03
Description		1/2" MSWT 8" x 7"	6" x 2-1/4" MSWT x CPVC (2 connectors)	1/2" FSWT x 1/2" FIP drop-ear 90	2 Power Bars, 3 TD clamps, 10 screws

Custom Kit Number: **693-13032303**

Custom Kit Price is the total for each component, added up. Kits are individually bagged, 12 kits/box. Minimum qty. = 12 kits.

## The Shower WallNut™



The ShowerUp™ system allows the use of a copper stub out elbow riser in conjunction with a Shower WallNut™ shower arm adapter. The Shower WallNut makes the shower arm connection outside the finished wall, so there are no hidden leaks. When a copper stub out elbow shower riser is used, Sioux Chief requires the use of the Shower WallNut system, including a StrongArm bracket with Shower WallNut LockBlock, and the Shower WallNut adapter. A properly installed Shower WallNut system carries a Limited Lifetime Warranty.

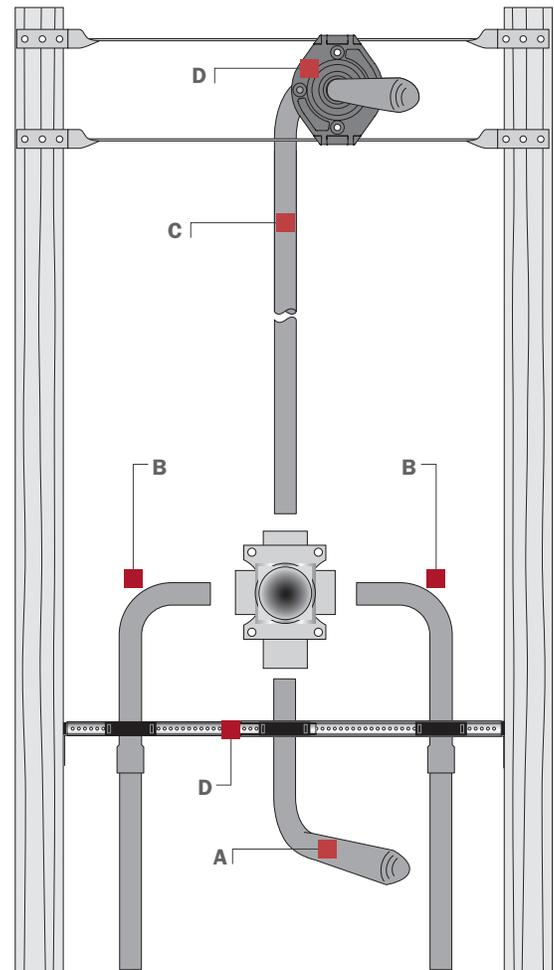

Supply

Drainage

Support

Specialties

Appendix

Supply

Drainage

Support

Specialties

Appendix



Kit Code: 16  
613-107

## A Tub Spout Elbow

### 1/2" Male Sweat Connection

Kit Code	Item No	Description	Lead Free
01	-	None (for shower only)	x
11	613-57	5" x 7"	x
12	613-67	6" x 7"	x
13	613-87	8" x 7"	x
14	613-137	13" x 7"	x
15	613-139	13" x 9"	x
16	613-107	10" x 7"	x
17	622-L03	1/2" x 3" Straight Stub Out	x



Kit Code: 02  
613-57X

### 1/2" MIP Connection

Kit Code	Item No	Description	Lead Free
02	613-57X	5" x 7", Swivel	
03	613-67X	6" x 7", Swivel	
04	613-87X	8" x 7", Swivel	
05	613-57M	5" x 7", Fixed	x
06	613-67M	6" x 7", Fixed	x
07	613-87M	8" x 7", Fixed	x



Kit Code: 31  
613-57Y

### 1/2" FIP Connection

Kit Code	Item No	Description	Lead Free
31	613-57Y	5" x 7", Swivel	x
32	613-67Y	6" x 7", Swivel	x
33	613-87Y	8" x 7", Swivel	x

DO NOT use pipe dope on FIP threads

## B Supply Connectors

### F1807 PEX Connection

Kit Code	Item No	Description	Lead Free
<b>SWEAT × F1807 PEX</b>			
14	632X243	4" × 2-1/4" MSWT × F1807 PEX	x
15	632X263	6" × 2-1/4" MSWT × F1807 PEX	x
16	632X222	1-5/8" × 1-1/2" MSWT × F1807 PEX	x
18	632X283	8" × 2-1/4" MSWT × F1807 PEX	x
63	660-TSX	MiniRester 1/2" MSWT Branch × 1/2" F1807 PEX	x
<b>MIP × F1807 PEX</b>			
11	646XG2	1/2" MIP × 1/2" F1807 PEX	x
12	632X263X	6" × 3" MIP Swivel × F1807 PEX	
<b>FIP × F1807 PEX</b>			
51	647XG2	1/2" FIP × 1/2" F1807 PEX	x
52	632X263Y	6" × 3" FIP Swivel × F1807 PEX	x

DO NOT use pipe dope on FIP swivel threads



Kit Code: 52  
632X263Y

Kit Code: 15  
632X263



Kit Code: 12  
632X263X

### F1960 PEX Connection

Kit Code	Item No	Description	Lead Free
<b>SWEAT × F1960 PEX</b>			
75	632WG263	6" × 2-1/4" MSWT × 1/2" F1960 PEX	x
<b>MIP × F1960 PEX</b>			
72	632W273X	7" × 3" MIP Swivel × F1960 PEX	
<b>FIP × F1960 PEX</b>			
76	632WG263Y	6" × 3" FIP Swivel × 1/2" F1960 PEX	x

DO NOT use pipe dope on FIP swivel threads

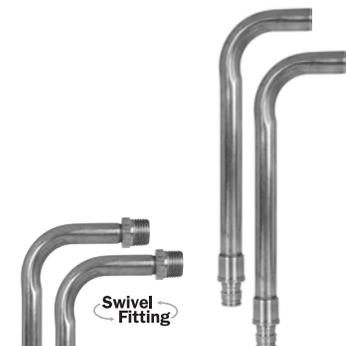

Kit Code: 72  
632W273X

Kit Code: 75  
632WG263



Kit Code: 76  
632WG263Y

## B Supply Connectors

Supply

Drainage

Support

Specialties

Appendix



Kit Code 81  
632V273



Kit Code 03  
632-C263

Kit Code 41  
637-C20



Kit Code 21  
609-L263A

### F3347 PEX Connection

Kit Code	Item No	Description	Lead Free
<b>SWEAT × F3347 PEX</b>			
81	632V273	7" × 2-1/4" MSWT × 1/2" F3347 PEX	x

### CPVC Connection

Kit Code	Item No	Description	Lead Free
<b>SWEAT × CPVC</b>			
03	632-C263	6" × 2-1/4" MSWT × CPVC	x
04	632-C283	8" × 2-1/4" MSWT × CPVC	x
<b>MIP × CPVC</b>			
01	646-CG2	1/2" MIP × 1/2" CPVC	x
02	632-C263X	6" × 3" MIP Swivel × CPVC	
<b>FIP × CPVC</b>			
41	637-C20	1/2" FIP Swivel × 1/2" CPVC	x
42	647-CG2	1/2" FIP × 1/2" CPVC	x

**DO NOT** use pipe dope on FIP swivel threads

### Sweat Connection

Kit Code	Item No	Description	Lead Free
<b>SWEAT × SWEAT</b>			
26	608-L263A	2-1/4" × 6" MSWT × 1/2" MSWT	x
61	660-TS	MiniRester 1/2" MSWT Branch × 1/2" FSWT	x
21	609-L263A	6" × 2-1/4" MSWT × FSWT	x

# C Shower Riser

## F1807 PEX Connection

Kit Code	Item No	Description	Lead Free
<b>SWEAT × F1807 PEX</b>			
17	643X2 630X248	1/2" MSWT × 1/2" F1807 PEX Adapter 4" × 8" F1807 PEX Stub Out Elbow	x
18	643X2 630X248E	1/2" MSWT × 1/2" F1807 PEX Adapter 4" × 8" F1807 PEX Stub Out Elbow with Ear Strap	x
19	643X2 647XG2E3	1/2" MSWT × 1/2" F1807 PEX Adapter 1/2" F1807 PEX × 1/2" FIP Drop-Ear 90	x
<b>MIP × F1807 PEX</b>			
11	646XG2 647X2E	1/2" MIP × 1/2" F1807 PEX Adapter 1/2" PEX × 1/2" FSWT Drop-Ear 90	x
12	646XG2 630X248	1/2" MIP × 1/2" PEX F1807 Adapter 4" × 8" F1807 PEX Stub Out Elbow	x
13	646XG2 630X248E	1/2" MIP × 1/2" PEX F1807 Adapter 4" × 8" F1807 PEX Stub Out Elbow with Ear Strap	x
<b>FIP × F1807 PEX</b>			
14	647XG2 647XG2E3	1/2" FIP × 1/2" F1807 PEX Adapter 1/2" F1807 PEX × 1/2" FSWT Drop-Ear 90	x
15	647XG2 630X248	1/2" FIP × 1/2" F1807 PEX Adapter 4" × 8" F1807 PEX Stub Out Elbow	x
16	647XG2 630X248E	1/2" FIP × 1/2" F1807 PEX Adapter 4" × 8" F1807 PEX Stub Out Elbow with Ear Strap	x

## F1960 PEX Connection

Kit Code	Item No	Description	Lead Free
<b>SWEAT × F1960 PEX</b>			
82	630WG248 643WG2	4" × 8" F1960 PEX Stub Out Elbow 1/2" MSWT × 1/2" F1960 PEX Adapter	x
91	647WG2E3 643WG2	1/2" F1960 PEX × 1/2" FIP Drop-Ear 90 1/2" MSWT × 1/2" F1960 PEX Adapter	x
<b>MIP × F1960 PEX</b>			
81	630WG248 646WG2	4" × 8" F1960 PEX Stub Out Elbow 1/2" MIP × 1/2" F1960 PEX Adapter	x
92	647WG2E3 646WG2	1/2" F1960 PEX × 1/2" FIP Drop-Ear 90 1/2" MIP × 1/2" F1960 PEX Adapter	x
<b>FIP × F1960 PEX</b>			
83	630WG248 647WG2	4" × 8" F1960 PEX Stub Out Elbow 1/2" FIP × 1/2" F1960 PEX Adapter	x
84	647WG2E3 647WG2	1/2" F1960 PEX × 1/2" FIP Drop-Ear 90 1/2" FIP × 1/2" F1960 PEX Adapter	x



Supply

Drainage

Support

Specialties

Appendix

# C Shower Riser

## CPVC Connection

Kit Code	Item No	Description	Lead Free
<b>MIP × CPVC</b>			
02	646-CG2 630-C248	1/2" MIP × 1/2" CPVC 4" × 8" CPVC Stub Out Elbow	x
03	646-CG2 630-C248E	1/2" MIP × 1/2" CPVC 4" × 8" CPVC Stub Out Elbow with Ear Strap	x
04	646-CG2 647-CG2E3	1/2" MIP × 1/2" CPVC 1/2" CPVC Drop-Ear 90	x
<b>FIP × CPVC</b>			
05	637-C20 647-CG2E3	1/2" FIP Swivel × 1/2" CPVC 1/2" CPVC Drop-Ear 90	x
06	637-C20 630-C248	1/2" FIP Swivel × 1/2" CPVC 4" × 8" CPVC Stub Out Elbow	x
07	637-C20 630-C248E	1/2" FIP Swivel × 1/2" CPVC 4" × 8" CPVC Stub Out Elbow with Ear Strap	x
08	647-CG2 647-CG2E3	1/2" FIP × 1/2" CPVC 1/2" CPVC Drop-Ear 90	x

**DO NOT** use pipe dope on FIP swivel threads

## Full-Length Copper

Kit Code	Item No	Description	Lead Free
<b>SWEAT</b>			
31	616-630	1/2" MSWT × Drop-Ear 90, 30"	
32	616-650	1/2" MSWT × Drop-Ear 90, 50"	
51	608-L2308	1/2" MSWT × Closed, 30" × 8" Stub Out Elbow	x
53	608-L2508	1/2" MSWT × Closed, 50" × 8" Stub Out Elbow	x
54	608-L2508E	1/2" MSWT × Closed, 50" × 8" Stub Out Elbow with Ear Strap	x
<b>MIP</b>			
41	616-630X	1/2" MIP swivel × Drop-Ear 90, 30"	
42	616-650X	1/2" MIP swivel × Drop-Ear 90, 50"	
<b>FIP</b>			
43	616-630Y	1/2" FIP swivel × Drop-Ear 90, 30"	
44	616-650Y	1/2" FIP swivel × Drop-Ear 90, 50"	

**DO NOT** use pipe dope on FIP swivel threads

Supply

Drainage

Support

Specialties

Appendix



Kit Code 43  
616-630Y

# C Shower Riser

## Sweat Connection

Kit Code	Item No	Description	Lead Free
<b>SWEAT</b>			
21	609-L248	1/2" FSWT x Closed, 4" x 8" Stub Out Elbow	x
22	609-L248E	1/2" FSWT x Closed 4" x 8" Stub Out Elbow with Ear Strap	x
23	616-2E3	1/2" FSWT x 1/2" FIP Drop-Ear 90	



Kit Code 22  
609-L248E

Kit Code 23  
616-2E3

# D Brackets

**Note:** When a copper stub out elbow shower riser is used, Sioux Chief requires the use of the Shower WallNut system, including a StrongArm bracket with Shower WallNut LockBlock, and the Shower WallNut adapter.

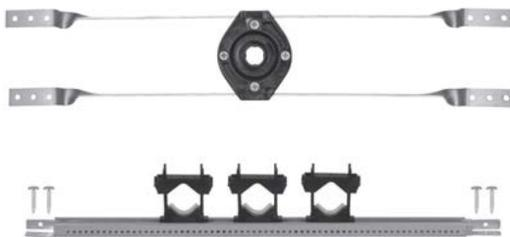

Kit Code 01  
525-16WLB  
523-2434



Kit Code 03  
523-2404  
523-2434

Kit Code	Item No	Description
01	525-16WLB 523-2434	StrongArm, 16", with 1 Shower WallNut LockBlock, 4 Screws PowerBar, 3 TouchDown Clamps, 4 Screws
02	523-2404 523-2424	PowerBar, 6 Screws PowerBar, 2 TouchDown Clamps, 4 Screws
03	523-2404 523-2434	PowerBar, 6 Screws PowerBar, 3 TouchDown Clamps, 4 screws
04	525-16WLB 523-2424	StrongArm, 16", with 1 Shower WallNut LockBlock, 4 Screws PowerBar, 2 TouchDown Clamps, 4 Screws

# Custom HeatUp™ Kits

Build-Your-Own Kit

Use the following steps to build a kit, using the codes from the following pages

### 1. Start with the HeatUp™ kit prefix:

Kit Prefix: 694

### 2. Choose a kit code for each component:

- A Hot-Side Connector
- B Cold-Side Connector
- C Expansion Tank Option

### 3. Use this format to build your kit:

Kit Prefix	A Hot-Side Connector	B Cold-Side Connector	C Expansion Tank Option
694	00	00	00

### 4. Example Item Creation:

Kit Components	Kit Prefix	A Hot-Side Connector	B Cold-Side Connector	C Expansion Tank Option
Kit Code	694	CG33	0120	91
Description		¾" FIP Swivel x ¾" CPVC Socket	¾" FIP Swivel x ¾" CPVC Socket, with Ball Valve	¾" x ¾" FIP Swivel with ¾" MIP Branch

New Custom Kit Number: **694CG33012091**

Custom Kit Price is the total for each component, added up. Kits are individually bagged, 10 kits/box. Minimum qty. = 10 kits.  
Note: Please include a \$2.00 kitting charge for all custom HeatUp™ kits.

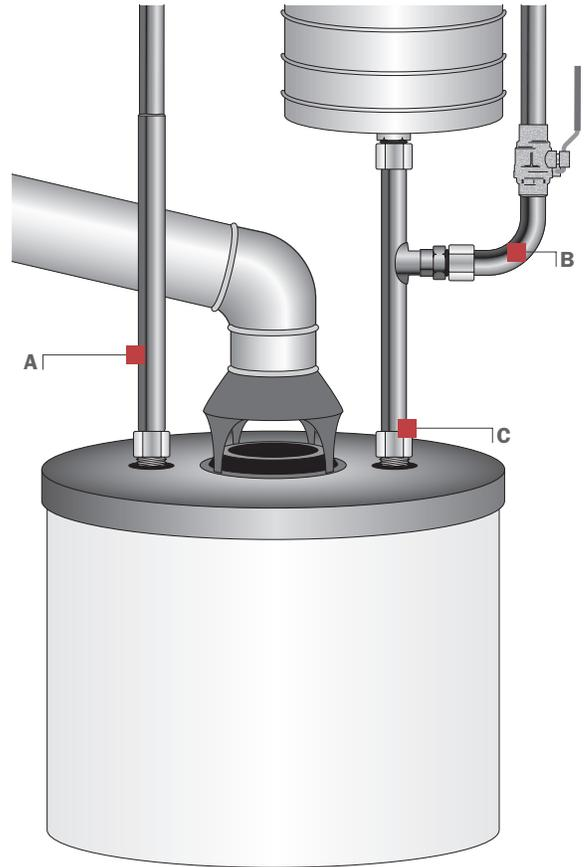

### Male Sweat Fittings



All Sioux Chief male sweat, preformed copper fittings are compatible with press-fit systems and all push fit systems. Do not use push fittings with nickel-plated stub outs.

### Lead-Free Compliant



Products indicated as Lead-Free comply with NSF-61 & 372 and with the California No Lead Plumbing Law.

### FGG/BM/CZ Compatible



All CPVC connections have been tested to assure chemical compatibility with FlowGuard Gold®, BlazeMaster®, and Corzan® pipe and fittings.  
\*Are registered trademarks of Lubrizol Corporation.



# A Hot Side Connection

## F1807 PEX Connection

Kit Code	Item No	Description	Length	Lead Free
XG06	631X02	3/4" F1807 PEX x 3/4" FIP Swivel Elbow	3" x 4 1/2"	x
XG31	633X02	3/4" F1807 PEX x 3/4" FIP Swivel	2"	x
XG32	633X18	3/4" F1807 PEX x 3/4" FIP Swivel	18"	x
XG46	634X418	3/4" F1807 PEX x 3/4" FIP Swivel Flexible	18"	x
XG61	646XG3	3/4" F1807 PEX x 3/4" MIP	-	x

**DO NOT** use pipe dope on FIP swivel threads  
**DO NOT** twist, kink, or loop flexible connectors



## F1960 PEX Connection

Kit Code	Item No	Description	Length	Lead Free
WG71	633WG18	3/4" F1960 PEX x 3/4" FIP Swivel	18"	x
WG49	634WG418	3/4" F1960 PEX x 3/4" FIP Swivel Flexible	18"	x
WG61	631WG02	3/4" F1960 PEX x 3/4" FIP Swivel Elbow	3" x 4"	x

**DO NOT** use pipe dope on FIP swivel threads  
**DO NOT** twist, kink, or loop flexible connectors



## F3347 PEX Connection

Kit Code	Item No	Description	Length	Lead Free
VG72	633VG18	3/4" F3347 PEX x 3/4" FIP Swivel	18"	x

**DO NOT** use pipe dope on FIP swivel threads



## A Hot Side Connection

### CPVC Connection



Kit Code	Item No	Description	Length	Lead Free
CG06	631-C307	3/4" FIP Swivel x 3/4" CPVC Socket Elbow	3" x 7"	x
CG31	633-C02	3/4" FIP Swivel x 3/4" CPVC Socket	3"	x
CG32	633-C09	3/4" FIP Swivel x 3/4" CPVC Socket	9"	x
CG33	633-C18	3/4" FIP Swivel x 3/4" CPVC Socket	18"	x
CG35	633-C24	3/4" FIP Swivel x 3/4" CPVC Socket	24"	x
CG36	633-C418	1" FIP Swivel x 3/4" CPVC Socket	18"	x
CG56	634-C118	3/4" FIP Swivel x 3/4" CPVC Socket Flexible	18"	x
CG71	646-CG3	3/4" MIP x 3/4" CPVC Socket	1-1/2"	x
CG72	646-CG318	3/4" MIP x 3/4" CPVC Socket	18"	x

**DO NOT** use pipe dope on FIP swivel threads  
**DO NOT** twist, kink, or loop flexible connectors

### Sweat Connection



Kit Code	Item No	Description	Length	Lead Free
-G21	633-312	3/4" FIP Swivel x 3/4" Full-Slip FSWT	12"	x
-G41	631-33F	3/4" FIP Swivel x 3/4" FSWT elbow	—	x
-G31	633-318	3/4" FIP Swivel x 3/4" MSWT	18"	x

**DO NOT** use pipe dope on FIP swivel threads

### PDQ™ Push Connection



Kit Code	Item No	Description	Length	Lead Free
Q31	633Q03	3/4" FIP Swivel x 3/4" Push Fit	2"	x
Q32	633Q18	3/4" FIP Swivel x 3/4" Push Fit	18"	x
Q46	634Q418	3/4" FIP Swivel x 3/4" Push Fit Flexible	18"	x

**DO NOT** use pipe dope on FIP swivel threads

## B Cold Side Connection

### F1807 PEX Connection

Kit Code	Item No	Description	Ball Valve	Length	Lead Free
0120	631XG02FP	3/4" F1807 PEX x 3/4" FIP Swivel Elbow	x	2-1/2" x 6"	x
2120	633XG18FP	3/4" F1807 PEX x 3/4" FIP Swivel	x	18"	x
2520	633XG18FPT	3/4" F1807 PEX x 3/4" FIP Swivel, with 3/4" FIP Branch	x	18"	x
4120	634XG418FP	3/4" F1807 PEX x 3/4" FIP Swivel Flexible	x	18"	x
2220	633XG18FRV	3/4" F1807 PEX x 3/4" FIP Swivel, with TERV 3/8" O.D. Compression	x	18"	x
2320	633XG18HRV	3/4" F1807 PEX x 3/4" FIP Swivel, with TERV 3/8" Hose Barb	x	18"	x
2420	633XG18XRV	3/4" F1807 PEX x 3/4" FIP Swivel, with TERV 1/2" F1807	x	18"	x

**DO NOT** use pipe dope on FIP swivel threads  
**DO NOT** twist, kink, or loop flexible connectors



### F1960 PEX Connections

Kit Code	Item No	Description	Ball Valve	Length	Lead Free
7520	633WG306FP	3/4" F1960 PEX x 3/4" FIP Swivel	x	6"	x
7620	633WG18FPT	3/4" F1960 PEX x 3/4" FIP Swivel, with 3/4" FIP Branch	x	18"	x
4520	634WG418FP	3/4" F1960 PEX x 3/4" FIP Swivel Flexible	x	18"	x
0220	631WG02FP	3/4" F1960 PEX x 3/4" FIP Swivel Elbow	x	7"	x
7720	633WG18FP	3/4" F1960 PEX x 3/4" FIP Swivel	x	18"	x
1720	633WG18FRV	3/4" F1960 PEX x 3/4" FIP Swivel, with TERV 3/8" O.D. Compression	x	18"	x
1820	633WG18HRV	3/4" F1960 PEX x 3/4" FIP Swivel, with TERV 3/8" Hose Barb	x	18"	x
1920	633WG18WRV	3/4" F1960 PEX x 3/4" FIP Swivel, with TERV 1/2" F1960	x	18"	x

**DO NOT** use pipe dope on FIP swivel threads  
**DO NOT** twist, kink, or loop flexible connectors



Supply

Drainage

Support

Specialties

Appendix

## B Cold Side Connection



Kit Code 4320  
634VG18FP

### F3347 PEX Connections

Kit Code	Item No	Description	Ball Valve	Length	Lead Free
4320	634VG18FP	3/4" F3347 PEX x 3/4" FIP Swivel Flexible	x	18"	x
7820	633VG18FP	3/4" F3347 PEX x 3/4" FIP Swivel	x	18"	x

**DO NOT** use pipe dope on FIP swivel threads  
**DO NOT** twist, kink, or loop flexible connectors



Kit Code 1720  
633-CG18FRV



Kit Code 5120  
634-CG118FP

### CPVC Connection

Kit Code	Item No	Description	Ball Valve	Length	Lead Free
0120	631-CG307FP	3/4" FIP Swivel x 3/4" CPVC Socket elbow	x	3" x 7"	x
1220	633-CG18FP	3/4" FIP Swivel x 3/4" CPVC Socket	x	18"	x
1420	633-CG24FP	3/4" FIP Swivel x 3/4" CPVC Socket	x	24"	x
1520	633-CG418FP	1" FIP Swivel x 3/4" CPVC Socket	x	18"	x
1720	633-CG18FRV	3/4" FIP Swivel x 3/4" CPVC Socket, with TERV 3/8" O.D. Compression	x	18"	x
1820	633-CG18HRV	3/4" FIP Swivel x 3/4" CPVC Socket, with TERV 3/8" Hose Barb	x	18"	x
2120	633-CG18FPT	3/4" FIP Swivel x 3/4" CPVC Socket, with 3/4" FIP Branch	x	18"	x
5120	634-CG118FP	3/4" FIP Swivel x 3/4" CPVC Socket Flexible	x	18"	x
6120	646-CG318FP	3/4" MIP x 3/4" CPVC Socket	x	18"	x

**DO NOT** use pipe dope on FIP swivel threads  
**DO NOT** twist, kink, or loop flexible connectors



Kit Code 2120  
633-CG18FPT



Kit Code 0120  
631-CG307FP

## B Cold Side Connection

### Sweat Connection

Kit Code	Item No	Description	Ball Valve	Length	Lead Free
1120	633-G312FP	3/4" FIP Swivel x 3/4" Full-Slip FSWT	x	12"	x
0120	631-G305FP	3/4" FIP Swivel x 3/4" FSWT Elbow	x	-	x
3520	633-G318FP	3/4" FIP Swivel x 3/4" MSWT	x	18"	x

**DO NOT** use pipe dope on FIP swivel threads



Kit Code 0120  
631-G305FP

Kit Code 1120  
633-G312FP

### PDQ™ Push Connection

Kit Code	Item No	Description	Length	Lead Free
26	633Q06FP	3/4" FIP Swivel x 3/4" Push Fit	6"	x
12	633Q18FP	3/4" FIP Swivel x 3/4" Push Fit	18"	x
41	634Q418FP	3/4" FIP Swivel x 3/4" Push Fit Flexible	18"	x

**DO NOT** use pipe dope on FIP swivel threads



Kit Code 26  
633Q06FP

Kit Code 41  
634Q418FP

## C Expansion Tank Option

Kit Code	Item No	Description	Length	Lead Free
-	-	No expansion tank	-	x
91	633-G3TM15	3/4" x 3/4" FIP Swivel with 3/4" MIP Branch	15"	x
92	633-G4TM15	1" x 3/4" FIP Swivel with 3/4" MIP Branch	15"	x
93	633-G3TM11	3/4" x 3/4" FIP Swivel with 3/4" MIP Branch	11"	x
94	633-G4TM11	1" x 3/4" FIP Swivel with 3/4" MIP Branch	11"	x

**DO NOT** use pipe dope on FIP swivel threads



Kit Code 91  
633-G3TM15

Kit Code 93  
633-G3TM11

## In-Stock Kits

Check out our other convenient kits - in stock and ready to ship



PowerPEX F1807  
Stub Out Kit

### • PowerPEX F1807 PEX Kits

- . . . in the PowerPEX Systems section
  - ShowerUp Kits
  - Stub Out Kits
  - Water Heater Connector Kits



PowerPEX F1807  
Water Heater Connector Kit

### • PowerPEX F1960 PEX Kits

- . . . in the PowerPEX Systems section
  - ShowerUp Kits
  - Stub Out Kits
  - Water Heater Connector Kits



PowerPEX F1960  
ShowerUp Kit

### • PowerPEX F3347 PEX Kits

- . . . in the PowerPEX Systems section
  - Stub Out Kits

### • CPVC Kits

- . . . in the Specialized Supply section
  - ShowerUp Kits
  - Stub Out Kits
  - Water Heater Connector Kits

### • Sweat Kits

- . . . in the Specialized Supply section
  - ShowerUp Kits
  - Water Heater Connector Kits

# **Drainage**

**Specification Drainage**

**Commercial Drainage**

**Trench Drains**

**Residential Drainage**

**Testing**





# **Specification Drainage**

**Floor Drains**

**Floor Sinks**

**Roof Drains**

**Cleanouts**

**Fixture Carriers**

# Specification Drainage

## Floor Drains

Adjustable and non-adjustable floor drains for on-grade and above-grade applications.  
Designed in accordance with *ASME A112.6.3 Standard for Floor and Trench Drains*.

**Note:** All floor drains installed in above-grade applications must be leak tested for watertightness according to local codes and standards. Failure to do so will void the warranty.

## Floor Sinks

Enamel-coated cast iron floor sinks designed for direct or indirect waste applications.  
Designed in accordance with *ASME A112.6.7 Standard for Sanitary Floor Sinks*.

**Note:** All floor sinks installed in above-grade applications must be leak tested for watertightness according to local codes and standards. Failure to do so will void the warranty.

## Roof Drains

Roof drain, overflow, scupper and accessory fixtures available with cast iron connections.  
Designed in accordance with *ASME A112.6.4 Standard for Roof, Deck, and Balcony Drains*.

**Note:** All roof drains must be leak tested for watertightness according to local codes and standards. Failure to do so will void the warranty.

## Cleanouts

Adjustable and non-adjustable cleanout fixtures provide access to drain lines.  
Designed in accordance with *ASME A112.36.2M Standard for Cleanouts*.

**Note:** All floor cleanouts installed in above-grade applications must be leak tested for watertightness according to local codes and standards. Failure to do so will void the warranty.

## Fixture Carriers

Floor-mounted Carriers and supports for commercial water closet and lavatory fixtures.

Designed in accordance with *ASME A112.6.1M Standard for Floor-Affixed Supports for Off-The-Floor Plumbing Fixtures for Public Use*.

# Specification Floor Drains

**FinishLine™ Floor Drains**

**FatMax™ Floor Drains**

**Above-Grade Floor Drains**

**Halo™ Floor Drains**

Sioux Chief's FinishLine™ Floor drain system is adjustable both before and AFTER the concrete pour.

The FinishLine™ virtually eliminates drains set too low or not level. Installations that are faster, easier, and more professional-looking.

**Floor Drain  
Accessories**





**832-4DNR**  
Page 245



**832-25DNR**  
Page 246



**832-6DNR**  
Page 247



**832-63DSQ**  
Page 248



**832-3SSR**  
Page 249



**833-22DNQ**  
Page 250



**833-225DSR**  
Page 251



**833-62DNQ**  
Page 253



**862-235NR**  
Page 255



**862-245SQ**  
Page 256



**862-249I**  
Page 257



**862-625NQ**  
Page 258



**862-627NRE**  
Page 259



**862-625SR**  
Page 259



**862-629I**  
Page 260



**822-2DNR**  
Page 261



**822-F3DNR**  
Page 262



**860-22I**  
Page 263



**860-Q222I**  
Page 264



**860-3SS**  
Page 265



**862-47LNRE**  
Page 266



**862-47LIN**  
Page 267



**835-3CQ**  
Page 245



**836-2**  
Page 268



**863-FACQ**  
Page 245

Cast Iron - No-Hub Connection

6-1/2" Tops

Options: Add suffix to item no. Add price to list

V = Vandal-Resistant Strainer: \$23.00; H = Hinged Strainer (1): \$54.00;

E = Extended Ring (2): \$267.00; B = Complies with Buy American Act (2): \$211.00;

M = Medium-duty strainer (3,000 lbs. safe-load) (3): \$134.00;

1: Not available for iron strainers 2: For round nickel bronze ring/strainer only 3: For round 304 SS ring/strainer only

Item Number	Item Description	Pkg Type	Min Qty	Case Qty	Price
<b>ROUGH-IN FIXTURE</b>					
832-3DF	3" No-Hub	Bl	1	5	\$270.00
832-4DF	4" No-Hub	Bl	1	5	\$270.00
<b>FINISH FIXTURE</b>					
832-4DHIR	6-1/2" Rnd Ductile Iron Ring & Strainer	Bl	1	10	\$290.00
832-4DHNQ	7" Sqr Nikl-Brnz Ring & Strainer	Bl	1	10	\$475.00
832-4DHNR	6-1/2" Rnd Nikl-Brnz Ring & Strainer	Bl	1	10	\$340.00
832-4DHSQ	7" Sqr Stnls Steel Ring & Strainer	Bl	1	10	\$475.00
832-4DHSR	6-1/2" Rnd Stnls Steel Ring & Strainer	Bl	1	10	\$340.00
<b>COMPLETE ASSEMBLY</b>					
832-3DIR	3" No-Hub - 6-1/2" Rnd Ductile Iron Ring & Strainer	Bl	1	1	\$560.00
832-3DNQ	3" No-Hub - 7" Sqr Nikl-Brnz Ring & Strainer	Bl	1	1	\$745.00
832-3DNR	3" No-Hub - 6-1/2" Rnd Nikl-Brnz Ring & Strainer	Bl	1	1	\$610.00
832-3DSQ	3" No-Hub - 7" Sqr Stnls Steel Ring & Strainer	Bl	1	1	\$745.00
832-3DSR	3" No-Hub - 6-1/2" Rnd Stnls Steel Ring & Strainer	Bl	1	1	\$610.00
832-4DIR	4" No-Hub - 6-1/2" Rnd Ductile Iron Ring & Strainer	Bl	1	1	\$560.00
832-4DNQ	4" No-Hub - 7" Sqr Nikl-Brnz Ring & Strainer	Bl	1	1	\$745.00
832-4DNR	4" No-Hub - 6-1/2" Rnd Nikl-Brnz Ring & Strainer	Bl	1	1	\$610.00
832-4DSQ	4" No-Hub - 7" Sqr Stnls Steel Ring & Strainer	Bl	1	1	\$745.00
832-4DSR	4" No-Hub - 6-1/2" Rnd Stnls Steel Ring & Strainer	Bl	1	1	\$610.00
<b>ACCESSORIES</b>					
832-EX4CQ	Ductile Iron Extension Adapter - 2" Min - 4" Max	Bl	1	1	\$120.00
832-PCQ	Coring Plug Wrench	Bl	1	1	\$87.00
832-S4CQ	Two Adjustment Shims, Two 3/4" Screws	Bl	1	10	\$22.00
832-UMCQ	4-1/4" Stainless Steel Debris Basket	Bl	1	15	\$75.00
832-WCQ	Flexible Red Locating Bristles w/ Screw	Bl	1	10	\$26.00
835-3CQ	Trapshield™ For 3" Drain Outlet	Bl	1	25	\$224.00
835-4CQ	Trapshield™ For 4" Drain Outlet	Bl	1	20	\$265.00
863-FACQ	Round Aluminum Condensate Funnel w/ Screws	Bl	1	12	\$168.00
863-FNCQ	Round Nikl-Brnz Condensate Funnel w/ Screws	Bl	1	12	\$370.00
863-FNOCQ	Oval Nikl-Brnz Condensate Funnel w/ Screws	Bl	1	12	\$815.00



832-3DF



Finish Fixture



832-4DNR



832-EX4CQ

Supply

Drainage

Support

Specialties

Appendix

Supply

Drainage

Support

Specialties

Appendix



832-25DF



832-3DHNQ



832-25DNR



832-PCQ

## Cast Iron - No-Hub Connection

### 5-1/2" Tops

**Options:** Add suffix to item no. Add price to list

**V** = Vandal-Resistant Strainer: \$23.00; **B** = Complies with Buy American Act (1): \$211.00;

**E** = Extended Ring (1): \$267.00;

1: For round nickel bronze ring/strainer only

Item Number	Item Description	Pkg Type	Min Qty	Case Qty	Price
<b>ROUGH-IN FIXTURE</b>					
832-25DF	2" No-Hub	BI	1	1	\$270.00
832-35DF	3" No-Hub	BI	1	1	\$270.00
<b>FINISH FIXTURE</b>					
832-3DHNQ	5-7/8" Sqr Nikl-Brnz Ring & Strainer	BI	1	1	\$360.00
832-3DHNR	5-1/2" Rnd Nikl-Brnz Ring & Strainer	BI	1	10	\$270.00
832-3DHSQ	5-7/8" Sqr Stnls Steel Ring & Strainer	BI	1	1	\$360.00
832-3DHSR	5-1/2" Rnd Stnls Steel Ring & Strainer	BI	1	1	\$270.00
<b>COMPLETE ASSEMBLY</b>					
832-25DNQ	2" No-Hub - 5-7/8" Sqr Nikl-Brnz Ring & Strainer	BI	1	1	\$630.00
832-25DNR	2" No-Hub - 5-1/2" Rnd Nikl-Brnz Ring & Strainer	BI	1	1	\$540.00
832-25DSQ	2" No-Hub - 5-7/8" Sqr Stnls Steel Ring & Strainer	BI	1	1	\$630.00
832-25DSR	2" No-Hub - 5-1/2" Rnd Stnls Steel Ring & Strainer	BI	1	1	\$540.00
832-35DNQ	3" No-Hub - 5-7/8" Sqr Nikl-Brnz Ring & Strainer	BI	1	1	\$630.00
832-35DNR	3" No-Hub - 5-1/2" Rnd Nikl-Brnz Ring & Strainer	BI	1	1	\$540.00
832-35DSQ	3" No-Hub - 5-7/8" Sqr Stnls Steel Ring & Strainer	BI	1	1	\$630.00
832-35DSR	3" No-Hub - 5-1/2" Rnd Stnls Steel Ring & Strainer	BI	1	1	\$540.00
<b>ACCESSORIES</b>					
832-EX3CQ	Ductile Iron Extension Adapter - 2" Min - 3-3/8" Max	BI	1	1	\$120.00
832-PCQ	Coring Plug Wrench	BI	1	1	\$87.00
832-S3CQ	Two Adjustment Shims, Two 3/4" Screws	BI	1	10	\$22.00
832-WCQ	Flexible Red Locating Bristles w/ Screw	BI	1	10	\$26.00
835-2CQ	Trapshield™ For 2" Drain Outlet	BI	1	50	\$199.00
835-3CQ	Trapshield™ For 3" Drain Outlet	BI	1	25	\$224.00
863-FACQ	Round Aluminum Condensate Funnel w/ Screws	BI	1	12	\$168.00
863-FNCQ	Round Nikl-Brnz Condensate Funnel w/ Screws	BI	1	12	\$370.00
863-FNOCQ	Oval Nikl-Brnz Condensate Funnel w/ Screws	BI	1	12	\$815.00

## Cast Iron - No-Hub Connection

### 9" Tops

**Options:** Add suffix to item no. Add price to list  
**V** = Vandal-Resistant Strainer: \$23.00; **C** = Clamping Collar: \$149.00;

Item Number	Item Description	Pkg Type	Min Qty	Case Qty	Price
<b>ROUGH-IN FIXTURE</b>					
832-49DF	4" No-Hub	BI	1	1	\$530.00
832-6DF	6" No-Hub	BI	1	1	\$530.00
<b>FINISH FIXTURE</b>					
832-6DHNR	9" Rnd Nikl-Brnz Ring & Strainer	BI	1	1	\$700.00
832-6DHSR	9" Rnd Stnls Steel Ring & Strainer	BI	1	1	\$700.00
<b>COMPLETE ASSEMBLY</b>					
832-49DNR	4" No-Hub - 9" Rnd Nikl-Brnz Ring & Strainer	BI	1	1	\$1,230.00
832-49DSR	4" No-Hub - 9" Rnd Stnls Steel Ring & Strainer	BI	1	1	\$1,230.00
832-6DNR	6" No-Hub - 9" Rnd Nikl-Brnz Ring & Strainer	BI	1	1	\$1,230.00
832-6DSR	6" No-Hub - 9" Rnd Stnls Steel Ring & Strainer	BI	1	1	\$1,230.00
<b>ACCESSORIES</b>					
832-PCQ	Coring Plug Wrench	BI	1	1	\$87.00
832-SD9	Ductile iron strainer - sets inside Coring Sleeve. Use in place of Finish Fixture	BI	1	1	\$306.00
832-WCQ	Flexible Red Locating Bristles w/ Screw	BI	1	10	\$26.00
835-4CQ	Trapshield™ For 4" Drain Outlet	BI	1	20	\$265.00
863-FACQ	Round Aluminum Condensate Funnel w/ Screws	BI	1	12	\$168.00
863-FNCQ	Round Nikl-Brnz Condensate Funnel w/ Screws	BI	1	12	\$370.00
863-FNOCQ	Oval Nikl-Brnz Condensate Funnel w/ Screws	BI	1	12	\$815.00



832-6DF



832-6DHNR



832-49DSR



832-WCQ

## Cast Iron - Push-Joint Connection

### 6-1/2" Tops

**Options:** Add suffix to item no. Add price to list  
**V** = Vandal-Resistant Strainer: \$23.00; **H** = Hinged Strainer (1): \$54.00;  
**E** = Extended Ring (2): \$267.00; **B** = Complies with Buy American Act (2): \$211.00;  
**M** = Medium-duty strainer (3,000 lbs. safe-load) (3): \$134.00; **P** = Push-joint gasket to fit Sch. 40 ABS/PVC pipe: \$25.00;

1: Not available for iron strainers 2: For round nickel bronze ring/strainer only 3: For round 304 SS ring/strainer only

Item Number	Item Description	Pkg Type	Min Qty	Case Qty	Price
<b>ROUGH-IN FIXTURE</b>					
832-63DF	3" PJ Conn.	BI	1	1	\$270.00
832-64DF	4" PJ Conn.	BI	1	1	\$270.00



832-63DF

Supply

Drainage

Support

Specialties

Appendix

Cast Iron - Push-Joint Connection (Cont)

6-1/2" Tops



832-4DHNQ



832-63DSQ



832-S4CQ

Item Number	Item Description	Pkg Type	Min Qty	Case Qty	Price
<b>FINISH FIXTURE</b>					
832-4DHIR	6-1/2" Rnd Ductile Iron Ring & Strainer	BI	1	10	\$290.00
832-4DHNQ	7" Sqr Nikl-Brnz Ring & Strainer	BI	1	10	\$475.00
832-4DHNR	6-1/2" Rnd Nikl-Brnz Ring & Strainer	BI	1	10	\$340.00
832-4DHSQ	7" Sqr Stnls Steel Ring & Strainer	BI	1	10	\$475.00
832-4DHSR	6-1/2" Rnd Stnls Steel Ring & Strainer	BI	1	10	\$340.00
<b>COMPLETE ASSEMBLY</b>					
832-63DIR	3" PJ Conn. - 6-1/2" Rnd Ductile Iron Ring & Strainer	BI	1	1	\$560.00
832-63DNQ	3" PJ Conn. - 7" Sqr Nikl-Brnz Ring & Strainer	BI	1	1	\$745.00
832-63DNR	3" PJ Conn. - 6-1/2" Rnd Nikl-Brnz Ring & Strainer	BI	1	1	\$610.00
832-63DSQ	3" PJ Conn. - 7" Sqr Stnls Steel Ring & Strainer	BI	1	1	\$745.00
832-63DSR	3" PJ Conn. - 6-1/2" Rnd Stnls Steel Ring & Strainer	BI	1	1	\$610.00
832-64DIR	4" PJ Conn. - 6-1/2" Rnd Ductile Iron Ring & Strainer	BI	1	1	\$560.00
832-64DNQ	4" PJ Conn. - 7" Sqr Nikl-Brnz Ring & Strainer	BI	1	1	\$745.00
832-64DNR	4" PJ Conn. - 6-1/2" Rnd Nikl-Brnz Ring & Strainer	BI	1	1	\$610.00
832-64DSQ	4" PJ Conn. - 7" Sqr Stnls Steel Ring & Strainer	BI	1	1	\$745.00
832-64DSR	4" PJ Conn. - 6-1/2" Rnd Stnls Steel Ring & Strainer	BI	1	1	\$610.00
<b>ACCESSORIES</b>					
832-EX4CQ	Ductile Iron Extension Adapter - 2" Min - 4" Max	BI	1	1	\$120.00
832-PCQ	Coring Plug Wrench	BI	1	1	\$87.00
832-S4CQ	Two Adjustment Shims, Two 3/4" Screws	BI	1	10	\$22.00
832-UMCQ	4-1/4" Stainless Steel Debris Basket	BI	1	15	\$75.00
832-WCQ	Flexible Red Locating Bristles w/ Screw	BI	1	10	\$26.00
835-3CQ	Trapshield™ For 3" Drain Outlet	BI	1	25	\$224.00
835-4CQ	Trapshield™ For 4" Drain Outlet	BI	1	20	\$265.00
858-PG3CQ	Push-Joint Gasket For 3" Sch. 40 Pipe	BI	1	20	\$60.00
858-PG4CQ	Push-Joint Gasket For 4" Sch. 40 Pipe	BI	1	20	\$60.00
863-FACQ	Round Aluminum Condensate Funnel w/ Screws	BI	1	12	\$168.00
863-FNCQ	Round Nikl-Brnz Condensate Funnel w/ Screws	BI	1	12	\$370.00
863-FNOCQ	Oval Nikl-Brnz Condensate Funnel w/ Screws	BI	1	12	\$815.00

Supply

Drainage

Support

Specialties

Appendix



**Stainless Steel - No-Hub Connection**

**6-1/2" Tops**

**Options:** Add suffix to item no. Add price to list  
**V** = Vandal-Resistant Strainer: \$23.00; **H** = Hinged Strainer: \$54.00;  
**M** = Medium-duty strainer (3,000 lbs. safe-load) (1): \$134.00;

1: Not available for square ring/strainer

Item Number	Item Description	Pkg Type	Min Qty	Case Qty	Price
<b>ROUGH-IN FIXTURE</b>					
832-3SF	3" No-Hub	Bl	1	1	\$1,500.00
832-4SF	4" No-Hub	Bl	1	1	\$1,500.00
<b>FINISH FIXTURE</b>					
832-4SHSQ	7" Sqr Stnls Steel Ring & Strainer	Bl	1	1	\$900.00
832-4SHSR	6-1/2" Rnd Stnls Steel Ring & Strainer	Bl	1	1	\$800.00
<b>COMPLETE ASSEMBLY</b>					
832-3SSQ	3" No-Hub - 7" Sqr Stnls Steel Ring & Strainer	Bl	1	1	\$2,400.00
832-3SSR	3" No-Hub - 6-1/2" Rnd Stnls Steel Ring & Strainer	Bl	1	1	\$2,300.00
832-4SSQ	4" No-Hub - 7" Sqr Stnls Steel Ring & Strainer	Bl	1	1	\$2,400.00
832-4SSR	4" No-Hub - 6-1/2" Rnd Stnls Steel Ring & Strainer	Bl	1	1	\$2,300.00
<b>ACCESSORIES</b>					
832-PCQ	Coring Plug Wrench	Bl	1	1	\$87.00
832-S4CQ	Two Adjustment Shims, Two 3/4" Screws	Bl	1	10	\$22.00
832-UMCQ	4-1/4" Stainless Steel Debris Basket	Bl	1	15	\$75.00
832-WCQ	Flexible Red Locating Bristles w/ Screw	Bl	1	10	\$26.00
835-3CQ	Trapshield™ For 3" Drain Outlet	Bl	1	25	\$224.00
835-4CQ	Trapshield™ For 4" Drain Outlet	Bl	1	20	\$265.00
863-FACQ	Round Aluminum Condensate Funnel w/ Screws	Bl	1	12	\$168.00
863-FNCQ	Round Nikl-Brnz Condensate Funnel w/ Screws	Bl	1	12	\$370.00
863-FNOCQ	Oval Nikl-Brnz Condensate Funnel w/ Screws	Bl	1	12	\$815.00



832-4SF



832-4SHSR



832-3SSR



835-3CQ

Supply

Drainage

Support

Specialties

Appendix

Cast Iron - No-Hub Connection

6-1/2" Tops

Options: Add suffix to item no. Add price to list

V = Vandal-Resistant Strainer: \$23.00; H = Hinged Strainer (1): \$54.00;

E = Extended Ring (2): \$267.00; B = Complies with Buy American Act (2): \$211.00;

M = Medium-duty strainer (3,000 lbs safe-load) (3): \$134.00;

1: Not available for iron strainers 2: For round nickel bronze ring/strainer only 3: For round 304 SS ring/strainer only



833-22DF



832-4DHIR



833-22DNQ

Item Number	Item Description	Pkg Type	Min Qty	Case Qty	Price
<b>ROUGH-IN FIXTURE</b>					
833-22DF	2" No-Hub	BI	1	1	\$370.00
833-23DF	3" No-Hub	BI	1	1	\$370.00
833-24DF	4" No-Hub	BI	1	1	\$370.00
<b>FINISH FIXTURE</b>					
832-4DHIR	6-1/2" Rnd Ductile Iron Ring & Strainer	BI	1	10	\$290.00
832-4DHNQ	7" Sqr Nikl-Brmz Ring & Strainer	BI	1	10	\$475.00
832-4DHNH	6-1/2" Rnd Nikl-Brmz Ring & Strainer	BI	1	10	\$340.00
832-4DHSQ	7" Sqr Stnls Steel Ring & Strainer	BI	1	10	\$475.00
832-4DHSR	6-1/2" Rnd Stnls Steel Ring & Strainer	BI	1	10	\$340.00
<b>COMPLETE ASSEMBLY</b>					
833-22DIR	2" No-Hub - 6-1/2" Rnd Ductile Iron Ring & Strainer	BI	1	1	\$660.00
833-22DNQ	2" No-Hub - 7" Sqr Nikl-Brmz Ring & Strainer	BI	1	1	\$845.00
833-22DNR	2" No-Hub - 6-1/2" Rnd Nikl-Brmz Ring & Strainer	BI	1	1	\$710.00
<b>833-22DSQ</b>	2" No-Hub - 7" Sqr Stnls Steel Ring & Strainer	BI	1	1	\$845.00
<b>833-22DSR</b>	2" No-Hub - 6-1/2" Rnd Stnls Steel Ring & Strainer	BI	1	1	\$710.00
<b>833-23DIR</b>	3" No-Hub - 6-1/2" Rnd Ductile Iron Ring & Strainer	BI	1	1	\$660.00
833-23DNQ	3" No-Hub - 7" Sqr Nikl-Brmz Ring & Strainer	BI	1	1	\$845.00
833-23DNR	3" No-Hub - 6-1/2" Rnd Nikl-Brmz Ring & Strainer	BI	1	1	\$710.00
<b>833-23DSQ</b>	3" No-Hub - 7" Sqr Stnls Steel Ring & Strainer	BI	1	1	\$845.00
<b>833-23DSR</b>	3" No-Hub - 6-1/2" Rnd Stnls Steel Ring & Strainer	BI	1	1	\$710.00
<b>833-24DIR</b>	4" No-Hub - 6-1/2" Rnd Ductile Iron Ring & Strainer	BI	1	1	\$660.00
<b>833-24DNQ</b>	4" No-Hub - 7" Sqr Nikl-Brmz Ring & Strainer	BI	1	1	\$845.00
833-24DNR	4" No-Hub - 6-1/2" Rnd Nikl-Brmz Ring & Strainer	BI	1	1	\$710.00
<b>833-24DSQ</b>	4" No-Hub - 7" Sqr Stnls Steel Ring & Strainer	BI	1	1	\$845.00
<b>833-24DSR</b>	4" No-Hub - 6-1/2" Rnd Stnls Steel Ring & Strainer	BI	1	1	\$710.00

Supply

Drainage

Support

Specialties

Appendix

**Cast Iron - No-Hub Connection (Cont)**

**6-1/2" Tops**

Item Number	Item Description	Pkg Type	Min Qty	Case Qty	Price
<b>ACCESSORIES</b>					
832-EX4CQ	Ductile Iron Extension Adapter - 2" Min - 4" Max	BI	1	1	\$120.00
832-PCQ	Coring Plug Wrench	BI	1	1	\$87.00
832-S4CQ	Two Adjustment Shims, Two 3/4" Screws	BI	1	10	\$22.00
832-UMCQ	4-1/4" Stainless Steel Debris Basket	BI	1	15	\$75.00
832-WCQ	Flexible Red Locating Bristles w/ Screw	BI	1	10	\$26.00
835-2CQ	Trapshield™ For 2" Drain Outlet	BI	1	50	\$199.00
835-3CQ	Trapshield™ For 3" Drain Outlet	BI	1	25	\$224.00
835-4CQ	Trapshield™ For 4" Drain Outlet	BI	1	20	\$265.00
863-FACQ	Round Aluminum Condensate Funnel w/ Screws	BI	1	12	\$168.00
863-FNCQ	Round Nikl-Brnz Condensate Funnel w/ Screws	BI	1	12	\$370.00
863-FNOCQ	Oval Nikl-Brnz Condensate Funnel w/ Screws	BI	1	12	\$815.00



832-EX4CQ

**Cast Iron - No-Hub Connection**

**5-1/2" Tops**

**Options:** Add suffix to item no. Add price to list  
**V** = Vandal-Resistant Strainer: \$23.00; **B** = Complies with Buy American Act (1): \$211.00;  
**E** = Extended ring (1): \$267.00;

1: For round nickel bronze ring/strainer only

Item Number	Item Description	Pkg Type	Min Qty	Case Qty	Price
<b>ROUGH-IN FIXTURE</b>					
833-225DF	2" No-Hub	BI	1	1	\$370.00
833-235DF	3" No-Hub	BI	1	1	\$370.00
<b>FINISH FIXTURE</b>					
832-3DHNQ	5-7/8" Sqr Nikl-Brnz Ring & Strainer	BI	1	1	\$360.00
832-3DHNH	5-1/2" Rnd Nikl-Brnz Ring & Strainer	BI	1	10	\$270.00
832-3DHSQ	5-7/8" Sqr Stnls Steel Ring & Strainer	BI	1	1	\$360.00
832-3DHSR	5-1/2" Rnd Stnls Steel Ring & Strainer	BI	1	1	\$270.00
<b>COMPLETE ASSEMBLY</b>					
833-225DNQ	2" No-Hub - 5-7/8" Sqr Nikl-Brnz Ring & Strainer	BI	1	1	\$730.00
833-225DNR	2" No-Hub - 5-1/2" Rnd Nikl-Brnz Ring & Strainer	BI	1	1	\$640.00
833-225DSQ	2" No-Hub - 5-7/8" Sqr Stnls Steel Ring & Strainer	BI	1	1	\$730.00
833-225DSR	2" No-Hub - 5-1/2" Rnd Stnls Steel Ring & Strainer	BI	1	1	\$640.00
833-235DNQ	3" No-Hub - 5-7/8" Sqr Nikl-Brnz Ring & Strainer	BI	1	1	\$730.00
833-235DNR	3" No-Hub - 5-1/2" Rnd Nikl-Brnz Ring & Strainer	BI	1	1	\$640.00
833-235DSQ	3" No-Hub - 5-7/8" Sqr Stnls Steel Ring & Strainer	BI	1	1	\$730.00
833-235DSR	3" No-Hub - 5-1/2" Rnd Stnls Steel Ring & Strainer	BI	1	1	\$640.00



833-225DF



832-3DHNQ



833-225DSR

Supply

Drainage

Support

Specialties

Appendix

Supply

Drainage

Support

Specialties

Appendix



835-3CQ

### Cast Iron - No-Hub Connection (Cont)

#### 5-1/2" Tops

Item Number	Item Description	Pkg Type	Min Qty	Case Qty	Price
<b>ACCESSORIES</b>					
832-EX3CQ	Ductile Iron Extension Adapter - 2" Min - 3-3/8" Max	BI	1	1	\$120.00
832-PCQ	Coring Plug Wrench	BI	1	1	\$87.00
832-S3CQ	Two Adjustment Shims, Two 3/4" Screws	BI	1	10	\$22.00
832-WCQ	Flexible Red Locating Bristles w/ Screw	BI	1	10	\$26.00
835-2CQ	Trapshield™ For 2" Drain Outlet	BI	1	50	\$199.00
835-3CQ	Trapshield™ For 3" Drain Outlet	BI	1	25	\$224.00
863-FACQ	Round Aluminum Condensate Funnel w/ Screws	BI	1	12	\$168.00
863-FNCQ	Round Nikl-Brnz Condensate Funnel w/ Screws	BI	1	12	\$370.00
863-FNOCQ	Oval Nikl-Brnz Condensate Funnel w/ Screws	BI	1	12	\$815.00

### Cast Iron - Push-Joint Connection

#### 6-1/2" Tops



833-62DF



832-4DHIR

**Options:** Add suffix to item no. Add price to list

**V** = Vandal-Resistant Strainer: \$23.00; **H** = Hinged Strainer (1): \$54.00;

**E** = Extended ring (2): \$267.00; **B** = Complies with Buy American Act (2): \$211.00;

**M** = Medium-duty strainer (3,000 lbs. safe-load) (3): \$134.00; **P** = Push-joint gasket to fit Sch. 40 ABS/PVC pipe (4): \$25.00;

1: Not available for iron strainers. 2: For round nickel bronze ring/strainer only 3: For round 304 SS ring/strainer only 4: Not available for 2" drains.

Item Number	Item Description	Pkg Type	Min Qty	Case Qty	Price
<b>ROUGH-IN FIXTURE</b>					
833-62DF	2" PJ Conn.	BI	1	1	\$370.00
833-63DF	3" PJ Conn.	BI	1	1	\$370.00
833-64DF	4" PJ Conn.	BI	1	1	\$370.00
<b>FINISH FIXTURE</b>					
832-4DHIR	6-1/2" Rnd Ductile Iron Ring & Strainer	BI	1	10	\$290.00
832-4DHNQ	7" Sqr Nikl-Brnz Ring & Strainer	BI	1	10	\$475.00
832-4DHNR	6-1/2" Rnd Nikl-Brnz Ring & Strainer	BI	1	10	\$340.00
832-4DHSQ	7" Sqr Stnls Steel Ring & Strainer	BI	1	10	\$475.00
832-4DHSR	6-1/2" Rnd Stnls Steel Ring & Strainer	BI	1	10	\$340.00

Cast Iron - Push-Joint Connection (Cont)

6-1/2" Tops

Item Number	Item Description	Pkg Type	Min Qty	Case Qty	Price
<b>COMPLETE ASSEMBLY</b>					
833-62DIR	2" PJ Conn. - 6-1/2" Rnd Ductile Iron Ring & Strainer	BI	1	1	\$660.00
833-62DNQ	2" PJ Conn. - 7" Sqr Nikl-Brnz Ring & Strainer	BI	1	1	\$845.00
833-62DNR	2" PJ Conn. - 6-1/2" Rnd Nikl-Brnz Ring & Strainer	BI	1	1	\$710.00
833-62DSQ	2" PJ Conn. - 7" Sqr Stnls Steel Ring & Strainer	BI	1	1	\$845.00
833-62DSR	2" PJ Conn. - 6-1/2" Rnd Stnls Steel Ring & Strainer	BI	1	1	\$710.00
833-63DIR	3" PJ Conn. - 6-1/2" Rnd Ductile Iron Ring & Strainer	BI	1	1	\$660.00
833-63DNQ	3" PJ Conn. - 7" Sqr Nikl-Brnz Ring & Strainer	BI	1	1	\$845.00
833-63DNR	3" PJ Conn. - 6-1/2" Rnd Nikl-Brnz Ring & Strainer	BI	1	1	\$710.00
833-63DSQ	3" PJ Conn. - 7" Sqr Stnls Steel Ring & Strainer	BI	1	1	\$845.00
833-63DSR	3" PJ Conn. - 6-1/2" Rnd Stnls Steel Ring & Strainer	BI	1	1	\$710.00
833-64DIR	4" PJ Conn. - 6-1/2" Rnd Ductile Iron Ring & Strainer	BI	1	1	\$660.00
833-64DNQ	4" PJ Conn. - 7" Sqr Nikl-Brnz Ring & Strainer	BI	1	1	\$845.00
833-64DNR	4" PJ Conn. - 6-1/2" Rnd Nikl-Brnz Ring & Strainer	BI	1	1	\$710.00
833-64DSQ	4" PJ Conn. - 7" Sqr Stnls Steel Ring & Strainer	BI	1	1	\$845.00
833-64DSR	4" PJ Conn. - 6-1/2" Rnd Stnls Steel Ring & Strainer	BI	1	1	\$710.00
<b>ACCESSORIES</b>					
832-EX4CQ	Ductile Iron Extension Adapter - 2" Min - 4" Max	BI	1	1	\$120.00
832-PCQ	Coring Plug Wrench	BI	1	1	\$87.00
832-S4CQ	Two Adjustment Shims, Two 3/4" Screws	BI	1	10	\$22.00
832-UMCQ	4-1/4" Stainless Steel Debris Basket	BI	1	15	\$75.00
832-WCQ	Flexible Red Locating Bristles w/ Screw	BI	1	10	\$26.00
835-2CQ	Trapshield™ For 2" Drain Outlet	BI	1	50	\$199.00
835-3CQ	Trapshield™ For 3" Drain Outlet	BI	1	25	\$224.00
835-4CQ	Trapshield™ For 4" Drain Outlet	BI	1	20	\$265.00
858-PG3CQ	Push-Joint Gasket For 3" Sch. 40 Pipe	BI	1	20	\$60.00
858-PG4CQ	Push-Joint Gasket For 4" Sch. 40 Pipe	BI	1	20	\$60.00
863-FACQ	Round Aluminum Condensate Funnel w/ Screws	BI	1	12	\$168.00
863-FNCQ	Round Nikl-Brnz Condensate Funnel w/ Screws	BI	1	12	\$370.00
863-FNOCQ	Oval Nikl-Brnz Condensate Funnel w/ Screws	BI	1	12	\$815.00



833-62DNQ



858-PG3CQ

Supply

Drainage

Support

Specialties

Appendix

**Cast Iron - Push-Joint Connection**  
**5-1/2" Tops**

**Options:** Add suffix to item no. Add price to list  
**V** = Vandal-Resistant Strainer: \$23.00; **B** = Complies with Buy American Act (1): \$211.00;  
**E** = Extended ring (1): \$267.00; **P** = Push-joint gasket to fit Sch. 40 pipe (2): \$25.00;

1: For round nickel bronze ring/strainer only 2: For 3" drains only.



833-635DF



832-3DHSR



833-625DSQ



832-EX3CQ

Item Number	Item Description	Pkg Type	Min Qty	Case Qty	Price
<b>ROUGH-IN FIXTURE</b>					
833-625DF	2" PJ Conn.	BI	1	1	\$370.00
833-635DF	3" PJ Conn.	BI	1	1	\$370.00
<b>FINISH FIXTURE</b>					
832-3DHNQ	5-7/8" Sqr Nikl-Brnz Ring & Strainer	BI	1	1	\$360.00
832-3DHNR	5-1/2" Rnd Nikl-Brnz Ring & Strainer	BI	1	10	\$270.00
832-3DHSQ	5-7/8" Sqr Stnls Steel Ring & Strainer	BI	1	1	\$360.00
832-3DHSR	5-1/2" Rnd Stnls Steel Ring & Strainer	BI	1	1	\$270.00
<b>COMPLETE ASSEMBLY</b>					
833-625DNQ	2" PJ Conn. - 5-7/8" Sqr Nikl-Brnz Ring & Strainer	BI	1	1	\$730.00
833-625DNR	2" PJ Conn. - 5-1/2" Rnd Nikl-Brnz Ring & Strainer	BI	1	1	\$640.00
833-625DSQ	2" PJ Conn. - 5-7/8" Sqr Stnls Steel Ring & Strainer	BI	1	1	\$730.00
833-625DSR	2" PJ Conn. - 5-1/2" Rnd Stnls Steel Ring & Strainer	BI	1	1	\$640.00
833-635DNQ	3" PJ Conn. - 5-7/8" Sqr Nikl-Brnz Ring & Strainer	BI	1	1	\$730.00
833-635DNR	3" PJ Conn. - 5-1/2" Rnd Nikl-Brnz Ring & Strainer	BI	1	1	\$640.00
833-635DSQ	3" PJ Conn. - 5-7/8" Sqr Stnls Steel Ring & Strainer	BI	1	1	\$730.00
833-635DSR	3" PJ Conn. - 5-1/2" Rnd Stnls Steel Ring & Strainer	BI	1	1	\$640.00
<b>ACCESSORIES</b>					
832-EX3CQ	Ductile Iron Extension Adapter - 2" Min - 3-3/8" Max	BI	1	1	\$120.00
832-PCQ	Coring Plug Wrench	BI	1	1	\$87.00
832-S3CQ	Two Adjustment Shims, Two 3/4" Screws	BI	1	10	\$22.00
832-WCQ	Flexible Red Locating Bristles w/ Screw	BI	1	10	\$26.00
835-2CQ	Trapshield™ For 2" Drain Outlet	BI	1	50	\$199.00
835-3CQ	Trapshield™ For 3" Drain Outlet	BI	1	25	\$224.00
858-PG3CQ	Push-Joint Gasket For 3" Sch. 40 Pipe	BI	1	20	\$60.00
863-FACQ	Round Aluminum Condensate Funnel w/ Screws	BI	1	12	\$168.00
863-FNCQ	Round Nikl-Brnz Condensate Funnel w/ Screws	BI	1	12	\$370.00
863-FNOCQ	Oval Nikl-Brnz Condensate Funnel w/ Screws	BI	1	12	\$815.00

Supply

Drainage

Support

Specialties

Appendix

**Cast Iron - No-Hub Connection**

**Nickel-Bronze Ring & Strainer**

Options: Add suffix to item no. Add price to list

A = Acid-Resistant Epoxy Coated Cast Iron: \$275.00; B = Sediment Bucket: \$105.00;

Item Number	Item Description	Pkg Type	Min Qty	Case Qty	Price
<b>5" ROUND STRAINER</b>					
862-225NR	2" No-Hub - 5" Nikl-Brnz Ring & Strainer	B	1	1	\$600.00
862-235NR	3" No-Hub - 5" Nikl-Brnz Ring & Strainer	B	1	1	\$600.00
862-245NR	4" No-Hub - 5" Nikl-Brnz Ring & Strainer	B	1	1	\$600.00
<b>6" ROUND STRAINER</b>					
862-226NR	2" No-Hub - 6" Nikl-Brnz Ring & Strainer	B	1	1	\$700.00
862-236NR	3" No-Hub - 6" Nikl-Brnz Ring & Strainer	B	1	1	\$700.00
862-246NR	4" No-Hub - 6" Nikl-Brnz Ring & Strainer	B	1	1	\$700.00
<b>7" ROUND STRAINER</b>					
862-227NR	2" No-Hub - 7" Nikl-Brnz Ring & Strainer	B	1	1	\$900.00
862-237NR	3" No-Hub - 7" Nikl-Brnz Ring & Strainer	B	1	1	\$900.00
862-247NR	4" No-Hub - 7" Nikl-Brnz Ring & Strainer	B	1	1	\$900.00
<b>8" ROUND STRAINER</b>					
862-228NR	2" No-Hub - 8" Nikl-Brnz Ring & Strainer	B	1	1	\$1,000.00
862-238NR	3" No-Hub - 8" Nikl-Brnz Ring & Strainer	B	1	1	\$1,000.00
862-248NR	4" No-Hub - 8" Nikl-Brnz Ring & Strainer	B	1	1	\$1,000.00
<b>10" ROUND STRAINER</b>					
862-2210NR	2" No-Hub - 10" Nikl-Brnz Ring & Strainer	B	1	1	\$1,300.00
862-2310NR	3" No-Hub - 10" Nikl-Brnz Ring & Strainer	B	1	1	\$1,300.00
862-2410NR	4" No-Hub - 10" Nikl-Brnz Ring & Strainer	B	1	1	\$1,300.00
<b>5" SQUARE STRAINER</b>					
862-225NQ	2" No-Hub - 5" Nikl-Brnz Ring & Strainer	B	1	1	\$720.00
862-235NQ	3" No-Hub - 5" Nikl-Brnz Ring & Strainer	B	1	1	\$720.00
862-245NQ	4" No-Hub - 5" Nikl-Brnz Ring & Strainer	B	1	1	\$720.00
<b>6" SQUARE STRAINER</b>					
862-226NQ	2" No-Hub - 6" Nikl-Brnz Ring & Strainer	B	1	1	\$820.00
862-236NQ	3" No-Hub - 6" Nikl-Brnz Ring & Strainer	B	1	1	\$820.00
862-246NQ	4" No-Hub - 6" Nikl-Brnz Ring & Strainer	B	1	1	\$820.00
<b>7" SQUARE STRAINER</b>					
862-227NQ	2" No-Hub - 7" Nikl-Brnz Ring & Strainer	B	1	1	\$1,000.00
862-237NQ	3" No-Hub - 7" Nikl-Brnz Ring & Strainer	B	1	1	\$1,000.00
862-247NQ	4" No-Hub - 7" Nikl-Brnz Ring & Strainer	B	1	1	\$1,000.00
<b>8" SQUARE STRAINER</b>					
862-228NQ	2" No-Hub - 8" Nikl-Brnz Ring & Strainer	B	1	1	\$1,300.00
862-238NQ	3" No-Hub - 8" Nikl-Brnz Ring & Strainer	B	1	1	\$1,300.00
862-248NQ	4" No-Hub - 8" Nikl-Brnz Ring & Strainer	B	1	1	\$1,300.00
<b>10" SQUARE STRAINER</b>					
862-2210NQ	2" No-Hub - 10" Nikl-Brnz Ring & Strainer	B	1	1	\$1,600.00
862-2310NQ	3" No-Hub - 10" Nikl-Brnz Ring & Strainer	B	1	1	\$1,600.00
862-2410NQ	4" No-Hub - 10" Nikl-Brnz Ring & Strainer	B	1	1	\$1,600.00
<b>ACCESSORIES</b>					
862-EX4	4" Threaded Extension Adapter - MIP X FIP	B	1	16	\$120.00
863-FACQ	Round Aluminum Condensate Funnel w/ Screws	BI	1	12	\$168.00
863-FNCQ	Round Nikl-Brnz Condensate Funnel w/ Screws	BI	1	12	\$370.00
863-FNOCQ	Oval Nikl-Brnz Condensate Funnel w/ Screws	BI	1	12	\$815.00



862-235NR



862-235NQ

Supply

Drainage

Support

Specialties

Appendix



862-247NRE

### Cast Iron - No-Hub Connection

#### Nickel-Bronze Ring & Strainer - Extended Rim

Options: Add suffix to item no. Add price to list

A = Acid-Resistant Epoxy Coated Cast Iron: \$275.00; B = Sediment Bucket: \$105.00;

Item Number	Item Description	Pkg Type	Min Qty	Case Qty	Price
<b>7" ROUND STRAINER</b>					
862-227NRE	2" No-Hub - 7" Nikl-Brnz Ring & Strainer	B	1	1	\$1,400.00
862-237NRE	3" No-Hub - 7" Nikl-Brnz Ring & Strainer	B	1	1	\$1,400.00
862-247NRE	4" No-Hub - 7" Nikl-Brnz Ring & Strainer	B	1	1	\$1,400.00
<b>10" ROUND STRAINER</b>					
862-2210NRE	2" No-Hub - 10" Nikl-Brnz Ring & Strainer	B	1	1	\$1,600.00
862-2310NRE	3" No-Hub - 10" Nikl-Brnz Ring & Strainer	B	1	1	\$1,600.00
862-2410NRE	4" No-Hub - 10" Nikl-Brnz Ring & Strainer	B	1	1	\$1,600.00
<b>ACCESSORIES</b>					
862-EX4	4" Threaded Extension Adapter - MIP X FIP	B	1	16	\$120.00



862-245SR



862-245SQ

### Cast Iron - No-Hub Connection

#### Stainless Steel Ring & Strainer

Options: Add suffix to item no. Add price to list

A = Acid-Resistant Epoxy Coated Cast Iron: \$275.00; B = Sediment Bucket: \$105.00;

Item Number	Item Description	Pkg Type	Min Qty	Case Qty	Price
<b>5" ROUND STRAINER</b>					
862-225SR	2" No-Hub - 5" Stnls Steel Ring & Strainer	B	1	1	\$1,100.00
862-235SR	3" No-Hub - 5" Stnls Steel Ring & Strainer	B	1	1	\$1,100.00
862-245SR	4" No-Hub - 5" Stnls Steel Ring & Strainer	B	1	1	\$1,100.00
<b>6" ROUND STRAINER</b>					
862-226SR	2" No-Hub - 6" Stnls Steel Ring & Strainer	B	1	1	\$1,350.00
862-236SR	3" No-Hub - 6" Stnls Steel Ring & Strainer	B	1	1	\$1,350.00
862-246SR	4" No-Hub - 6" Stnls Steel Ring & Strainer	B	1	1	\$1,350.00
<b>5" SQUARE STRAINER</b>					
862-225SQ	2" No-Hub - 5" Stnls Steel Ring & Strainer	B	1	1	\$1,200.00
862-235SQ	3" No-Hub - 5" Stnls Steel Ring & Strainer	B	1	1	\$1,200.00
862-245SQ	4" No-Hub - 5" Stnls Steel Ring & Strainer	B	1	1	\$1,200.00
<b>6" SQUARE STRAINER</b>					
862-226SQ	2" No-Hub - 6" Stnls Steel Ring & Strainer	B	1	1	\$1,440.00
862-236SQ	3" No-Hub - 6" Stnls Steel Ring & Strainer	B	1	1	\$1,440.00
862-246SQ	4" No-Hub - 6" Stnls Steel Ring & Strainer	B	1	1	\$1,440.00
<b>ACCESSORIES</b>					
862-EX4	4" Threaded Extension Adapter - MIP X FIP	B	1	16	\$120.00



## Cast Iron - No-Hub Connection

### Cast Iron Strainer

**Options:** Add suffix to item no. Add price to list

**A** = Acid-Resistant Epoxy Coated Cast Iron: \$275.00; **B** = Sediment Bucket: \$105.00;

Item Number	Item Description	Pkg Type	Min Qty	Case Qty	Price
<b>7" ROUND STRAINER</b>					
862-227I	2" No-Hub - 7" Ductile Iron Ring & Strainer	B	1	1	\$700.00
862-227IN	2" No-Hub - 7-1/4" Ductile Iron w/ NB Veneer Ring & Strainer	B	1	1	\$900.00
862-237I	3" No-Hub - 7" Ductile Iron Ring & Strainer	B	1	1	\$700.00
862-237IN	3" No-Hub - 7-1/4" Ductile Iron w/ NB Veneer Ring & Strainer	B	1	1	\$900.00
862-247I	4" No-Hub - 7" Ductile Iron Ring & Strainer	B	1	1	\$700.00
862-247IN	4" No-Hub - 7-1/4" Ductile Iron w/ NB Veneer Ring & Strainer	B	1	1	\$900.00
<b>9" ROUND STRAINER</b>					
862-229I	2" No-Hub - 9" Ductile Iron Ring & Strainer	B	1	1	\$900.00
862-229IN	2" No-Hub - 9-3/8" Ductile Iron w/ NB Veneer Ring & Strainer	B	1	1	\$1,250.00
862-239I	3" No-Hub - 9" Ductile Iron Ring & Strainer	B	1	1	\$900.00
862-239IN	3" No-Hub - 9-3/8" Ductile Iron w/ NB Veneer Ring & Strainer	B	1	1	\$1,250.00
862-249I	4" No-Hub - 9" Ductile Iron Ring & Strainer	B	1	1	\$900.00
862-249IN	4" No-Hub - 9-3/8" Ductile Iron w/ NB Veneer Ring & Strainer	B	1	1	\$1,250.00
<b>9" SQUARE STRAINER</b>					
862-229INQ	2" No-Hub - 9-3/8" Ductile Iron w/ NB Veneer Ring & Strainer	B	1	1	\$1,450.00
862-229IQ	2" No-Hub - 9" Ductile Iron Ring & Strainer	B	1	1	\$1,100.00
862-239INQ	3" No-Hub - 9-3/8" Ductile Iron w/ NB Veneer Ring & Strainer	B	1	1	\$1,450.00
862-239IQ	3" No-Hub - 9" Ductile Iron Ring & Strainer	B	1	1	\$1,100.00
862-249INQ	4" No-Hub - 9-3/8" Ductile Iron w/ NB Veneer Ring & Strainer	B	1	1	\$1,450.00
862-249IQ	4" No-Hub - 9" Ductile Iron Ring & Strainer	B	1	1	\$1,100.00
<b>ACCESSORIES</b>					
862-EX4	4" Threaded Extension Adapter - MIP X FIP	B	1	16	\$120.00

## Cast Iron - Push-Joint Connection

### Nickel-Bronze Ring & Strainer

**Options:** Add suffix to item no. Add price to list

**A** = Acid-Resistant Epoxy Coated Cast Iron: \$275.00; **B** = Sediment Bucket: \$105.00;

Item Number	Item Description	Pkg Type	Min Qty	Case Qty	Price
<b>5" ROUND STRAINER</b>					
862-625NR	2" PJ Conn. - 5" Nikl-Brnz Ring & Strainer	B	1	1	\$600.00
862-635NR	3" PJ Conn. - 5" Nikl-Brnz Ring & Strainer	B	1	1	\$600.00
862-645NR	4" PJ Conn. - 5" Nikl-Brnz Ring & Strainer	B	1	1	\$600.00



862-237I



862-237IN



862-239I



862-239INQ



862-625NR

Supply

Drainage

Support

Specialties

Appendix



862-625NQ

### Cast Iron - Push-Joint Connection (Cont)

#### Nickel-Bronze Ring & Strainer

Item Number	Item Description	Pkg Type	Min Qty	Case Qty	Price
<b>6" ROUND STRAINER</b>					
862-626NR	2" PJ Conn. - 6" Nikl-Brnz Ring & Strainer	B	1	1	\$700.00
862-636NR	3" PJ Conn. - 6" Nikl-Brnz Ring & Strainer	B	1	1	\$700.00
862-646NR	4" PJ Conn. - 6" Nikl-Brnz Ring & Strainer	B	1	1	\$700.00
<b>7" ROUND STRAINER</b>					
862-627NR	2" PJ Conn. - 7" Nikl-Brnz Ring & Strainer	B	1	1	\$900.00
862-637NR	3" PJ Conn. - 7" Nikl-Brnz Ring & Strainer	B	1	1	\$900.00
862-647NR	4" PJ Conn. - 7" Nikl-Brnz Ring & Strainer	B	1	1	\$845.00
<b>8" ROUND STRAINER</b>					
862-628NR	2" PJ Conn. - 8" Nikl-Brnz Ring & Strainer	B	1	1	\$1,000.00
862-638NR	3" PJ Conn. - 8" Nikl-Brnz Ring & Strainer	B	1	1	\$1,000.00
862-648NR	4" PJ Conn. - 8" Nikl-Brnz Ring & Strainer	B	1	1	\$1,000.00
<b>10" ROUND STRAINER</b>					
862-6210NR	2" PJ Conn. - 10" Nikl-Brnz Ring & Strainer	B	1	1	\$1,300.00
862-6310NR	3" PJ Conn. - 10" Nikl-Brnz Ring & Strainer	B	1	1	\$1,300.00
862-6410NR	4" PJ Conn. - 10" Nikl-Brnz Ring & Strainer	B	1	1	\$1,300.00
<b>5" SQUARE STRAINER</b>					
862-625NQ	2" PJ Conn. - 5" Nikl-Brnz Ring & Strainer	B	1	1	\$720.00
862-635NQ	3" PJ Conn. - 5" Nikl-Brnz Ring & Strainer	B	1	1	\$720.00
862-645NQ	4" PJ Conn. - 5" Nikl-Brnz Ring & Strainer	B	1	1	\$720.00
<b>6" SQUARE STRAINER</b>					
862-626NQ	2" PJ Conn. - 6" Nikl-Brnz Ring & Strainer	B	1	1	\$820.00
862-636NQ	3" PJ Conn. - 6" Nikl-Brnz Ring & Strainer	B	1	1	\$820.00
862-646NQ	4" PJ Conn. - 6" Nikl-Brnz Ring & Strainer	B	1	1	\$820.00
<b>7" SQUARE STRAINER</b>					
862-627NQ	2" PJ Conn. - 7" Nikl-Brnz Ring & Strainer	B	1	1	\$1,000.00
862-637NQ	3" PJ Conn. - 7" Nikl-Brnz Ring & Strainer	B	1	1	\$1,000.00
862-647NQ	4" PJ Conn. - 7" Nikl-Brnz Ring & Strainer	B	1	1	\$1,000.00
<b>8" SQUARE STRAINER</b>					
862-628NQ	2" PJ Conn. - 8" Nikl-Brnz Ring & Strainer	B	1	1	\$1,300.00
862-638NQ	3" PJ Conn. - 8" Nikl-Brnz Ring & Strainer	B	1	1	\$1,300.00
862-648NQ	4" PJ Conn. - 8" Nikl-Brnz Ring & Strainer	B	1	1	\$1,300.00
<b>10" SQUARE STRAINER</b>					
862-6210NQ	2" PJ Conn. - 10" Nikl-Brnz Ring & Strainer	B	1	1	\$1,600.00
862-6310NQ	3" PJ Conn. - 10" Nikl-Brnz Ring & Strainer	B	1	1	\$1,600.00
862-6410NQ	4" PJ Conn. - 10" Nikl-Brnz Ring & Strainer	B	1	1	\$1,600.00
<b>ACCESSORIES</b>					
862-EX4	4" Threaded Extension Adapter - MIP X FIP	B	1	16	\$120.00
863-FACQ	Round Aluminum Condensate Funnel w/ Screws	BI	1	12	\$168.00
863-FNCQ	Round Nikl-Brnz Condensate Funnel w/ Screws	BI	1	12	\$370.00
863-FNOCQ	Oval Nikl-Brnz Condensate Funnel w/ Screws	BI	1	12	\$815.00

## Cast Iron - Push-Joint Connection

### Nickel-Bronze Ring & Strainer - Extended Rim

Options: Add suffix to item no. Add price to list

A = Acid-Resistant Epoxy Coated Cast Iron: \$275.00; B = Sediment Bucket: \$105.00;

Item Number	Item Description	Pkg Type	Min Qty	Case Qty	Price
<b>7" ROUND STRAINER</b>					
862-627NRE	2" PJ Conn. - 7" Nikl-Brnz Ring & Strainer	B	1	1	\$1,400.00
862-637NRE	3" PJ Conn. - 7" Nikl-Brnz Ring & Strainer	B	1	1	\$1,400.00
862-647NRE	4" PJ Conn. - 7" Nikl-Brnz Ring & Strainer	B	1	1	\$1,400.00
<b>10" ROUND STRAINER</b>					
862-6210NRE	2" PJ Conn. - 10" Nikl-Brnz Ring & Strainer	B	1	1	\$1,600.00
862-6310NRE	3" PJ Conn. - 10" Nikl-Brnz Ring & Strainer	B	1	1	\$1,600.00
862-6410NRE	4" PJ Conn. - 10" Nikl-Brnz Ring & Strainer	B	1	1	\$1,600.00
<b>ACCESSORIES</b>					
862-EX4	4" Threaded Extension Adapter - MIP X FIP	B	1	16	\$120.00



862-627NRE

## Cast Iron - Push-Joint Connection

### Stainless Steel Ring & Strainer

Options: Add suffix to item no. Add price to list

A = Acid-Resistant Epoxy Coated Cast Iron: \$275.00; B = Sediment Bucket: \$105.00;

Item Number	Item Description	Pkg Type	Min Qty	Case Qty	Price
<b>5" ROUND STRAINER</b>					
862-625SR	2" PJ Conn. - 5" Stnls Steel Ring & Strainer	B	1	1	\$1,100.00
862-635SR	3" PJ Conn. - 5" Stnls Steel Ring & Strainer	B	1	1	\$1,100.00
862-645SR	4" PJ Conn. - 5" Stnls Steel Ring & Strainer	B	1	1	\$1,100.00
<b>6" ROUND STRAINER</b>					
862-626SR	2" PJ Conn. - 6" Stnls Steel Ring & Strainer	B	1	1	\$1,350.00
862-636SR	3" PJ Conn. - 6" Stnls Steel Ring & Strainer	B	1	1	\$1,350.00
862-646SR	4" PJ Conn. - 6" Stnls Steel Ring & Strainer	B	1	1	\$1,350.00
<b>5" SQUARE STRAINER</b>					
862-625SQ	2" PJ Conn. - 5" Stnls Steel Ring & Strainer	B	1	1	\$1,200.00
862-635SQ	3" PJ Conn. - 5" Stnls Steel Ring & Strainer	B	1	1	\$1,200.00
862-645SQ	4" PJ Conn. - 5" Stnls Steel Ring & Strainer	B	1	1	\$1,200.00
<b>6" SQUARE STRAINER</b>					
862-626SQ	2" PJ Conn. - 6" Stnls Steel Ring & Strainer	B	1	1	\$1,440.00
862-636SQ	3" PJ Conn. - 6" Stnls Steel Ring & Strainer	B	1	1	\$1,440.00
862-646SQ	4" PJ Conn. - 6" Stnls Steel Ring & Strainer	B	1	1	\$1,440.00
<b>ACCESSORIES</b>					
862-EX4	4" Threaded Extension Adapter - MIP X FIP	B	1	16	\$120.00



862-625SR



862-625SQ

**Cast Iron - Push-Joint Connection**

**Cast Iron Strainer**

**Options:** Add suffix to item no. Add price to list  
**A** = Acid-Resistant Epoxy Coated Cast Iron: \$275.00; **B** = Sediment Bucket: \$105.00;



862-627I



862-627IN



862-629I



862-639IQ

Item Number	Item Description	Pkg Type	Min Qty	Case Qty	Price
<b>7" ROUND STRAINER</b>					
862-627I	2" PJ Conn. - 7" Ductile Iron Ring & Strainer	B	1	1	\$700.00
862-627IN	2" PJ Conn. - 7-1/4" Ductile Iron w/ NB Veneer Ring & Strainer	B	1	1	\$900.00
862-637I	3" PJ Conn. - 7" Ductile Iron Ring & Strainer	B	1	1	\$700.00
862-637IN	3" PJ Conn. - 7-1/4" Ductile Iron w/ NB Veneer Ring & Strainer	B	1	1	\$900.00
862-647I	4" PJ Conn. - 7" Ductile Iron Ring & Strainer	B	1	1	\$700.00
862-647IN	4" PJ Conn. - 7-1/4" Ductile Iron w/ NB Veneer Ring & Strainer	B	1	1	\$900.00
<b>9" ROUND STRAINER</b>					
862-629I	2" PJ Conn. - 9" Ductile Iron Ring & Strainer	B	1	1	\$900.00
862-629IN	2" PJ Conn. - 9-3/8" Ductile Iron w/ NB Veneer Ring & Strainer	B	1	1	\$1,250.00
862-639I	3" PJ Conn. - 9" Ductile Iron Ring & Strainer	B	1	1	\$900.00
862-639IN	3" PJ Conn. - 9-3/8" Ductile Iron w/ NB Veneer Ring & Strainer	B	1	1	\$1,250.00
862-649I	4" PJ Conn. - 9" Ductile Iron Ring & Strainer	B	1	1	\$900.00
862-649IN	4" PJ Conn. - 9-3/8" Ductile Iron w/ NB Veneer Ring & Strainer	B	1	1	\$1,250.00
<b>9" SQUARE STRAINER</b>					
862-629IQ	2" PJ Conn. - 9-3/8" Ductile Iron w/ NB Veneer Ring & Strainer	B	1	1	\$1,450.00
862-629IQ	2" PJ Conn. - 9" Ductile Iron Ring & Strainer	B	1	1	\$1,100.00
862-639IQ	3" PJ Conn. - 9-3/8" Ductile Iron w/ NB Veneer Ring & Strainer	B	1	1	\$1,450.00
862-639IQ	3" PJ Conn. - 9" Ductile Iron Ring & Strainer	B	1	1	\$1,100.00
862-649IQ	4" PJ Conn. - 9-3/8" Ductile Iron w/ NB Veneer Ring & Strainer	B	1	1	\$1,450.00
862-649IQ	4" PJ Conn. - 9" Ductile Iron Ring & Strainer	B	1	1	\$1,100.00
<b>ACCESSORIES</b>					
862-EX4	4" Threaded Extension Adapter - MIP X FIP	B	1	16	\$120.00

Supply

Drainage

Support

Specialties

Appendix

Halo™ Floor Drains

Cast Iron - No-Hub Connection

Options: Add suffix to item no. Add price to list

M = Clamping collar kit (1): \$70.00; V = Vandal-Resistant Strainer: \$23.00;

B = Complies with Buy American Act (2): \$211.00; E = Extended Ring (2): \$267.00;

9 = 90-deg. Side Outlet Connection: \$86.00;

1: Add 'M' code after dash - other options to end of item no. 2: For round nickel bronze ring/strainer only

Item Number	Item Description	Pkg Type	Min Qty	Case Qty	Price
<b>NICKEL-BRONZE RING &amp; STRAINER</b>					
822-2DNQ	2" No-Hub - 5-7/8" Sqr Ring & Strainer	BI	1	4	\$620.00
822-2DNR	2" No-Hub - 5-1/2" Rnd Ring & Strainer	BI	1	4	\$525.00
822-3DNQ	3" No-Hub - 5-7/8" Sqr Ring & Strainer	BI	1	4	\$620.00
822-3DNR	3" No-Hub - 5-1/2" Rnd Ring & Strainer	BI	1	4	\$525.00
<b>STAINLESS STEEL RING &amp; STRAINER</b>					
822-2DSQ	2" No-Hub - 5-7/8" Sqr Ring & Strainer	BI	1	4	\$620.00
822-2DSR	2" No-Hub - 5-1/2" Rnd Ring & Strainer	BI	1	4	\$525.00
822-3DSQ	3" No-Hub - 5-7/8" Sqr Ring & Strainer	BI	1	1	\$620.00
822-3DSR	3" No-Hub - 5-1/2" Rnd Ring & Strainer	BI	1	1	\$525.00
<b>ACCESSORIES</b>					
822-EX3CQ	Ductile Iron Extension Adapter	BI	1	1	\$125.00
835-2CQ	Trapshield™ For 2" Drain Outlet	BI	1	50	\$199.00
835-35CQ	Trapshield™ For 3-1/2" Drain Outlet	BI	1	25	\$224.00
835-3CQ	Trapshield™ For 3" Drain Outlet	BI	1	25	\$224.00
863-FACQ	Round Aluminum Condensate Funnel w/ Screws	BI	1	12	\$168.00
863-FNCQ	Round Nikl-Brnz Condensate Funnel w/ Screws	BI	1	12	\$370.00



822-2DNR



822-2DSQ

FinishLine Halo™ Floor Drains

Cast Iron - No-Hub Connection

Options: Add suffix to item no. Add price to list

M = Clamping collar kit (1): \$70.00; V = Vandal-Resistant Strainer: \$23.00;

B = Complies with Buy American Act (2): \$211.00; E = Extended Ring (2): \$267.00;

9 = 90-deg. Side Outlet Connection: \$86.00;

1: Add 'M' code after dash - other options to end of item no. 2: For round nickel bronze ring/strainer only

Item Number	Item Description	Pkg Type	Min Qty	Case Qty	Price
<b>ROUGH-IN FIXTURE</b>					
822-2DF	2" No-Hub	BI	1	1	\$330.00
822-3DF	3" No-Hub	BI	1	4	\$330.00
<b>FINISH FIXTURE</b>					
832-3DHNQ	5-7/8" Sqr Nikl-Brnz Ring & Strainer	BI	1	1	\$360.00
832-3DHNR	5-1/2" Rnd Nikl-Brnz Ring & Strainer	BI	1	10	\$270.00
832-3DHSQ	5-7/8" Sqr Stnls Steel Ring & Strainer	BI	1	1	\$360.00
832-3DHSR	5-1/2" Rnd Stnls Steel Ring & Strainer	BI	1	1	\$270.00



822-2DF



832-3DHNQ

Supply

Drainage

Support

Specialties

Appendix



822-F3DSR

## FinishLine Halo™ Floor Drains (Cont)

### Cast Iron - No-Hub Connection

Item Number	Item Description	Pkg Type	Min Qty	Case Qty	Price
<b>COMPLETE ASSEMBLY</b>					
822-F2DNQ	2" No-Hub - 5-7/8" Sqr Nikl-Brnz Ring & Strainer	BI	1	1	\$690.00
822-F2DNR	2" No-Hub - 5-1/2" Rnd Nikl-Brnz Ring & Strainer	BI	1	1	\$600.00
822-F2DSQ	2" No-Hub - 5-7/8" Sqr Stnls Steel Ring & Strainer	BI	1	1	\$690.00
822-F2DSR	2" No-Hub - 5-1/2" Rnd Stnls Steel Ring & Strainer	BI	1	1	\$600.00
822-F3DNQ	3" No-Hub - 5-7/8" Sqr Nikl-Brnz Ring & Strainer	BI	1	1	\$690.00
822-F3DNR	3" No-Hub - 5-1/2" Rnd Nikl-Brnz Ring & Strainer	BI	1	1	\$600.00
822-F3DSQ	3" No-Hub - 5-7/8" Sqr Stnls Steel Ring & Strainer	BI	1	1	\$690.00
822-F3DSR	3" No-Hub - 5-1/2" Rnd Stnls Steel Ring & Strainer	BI	1	1	\$600.00
<b>ACCESSORIES</b>					
822-EX3CQ	Ductile Iron Extension Adapter	BI	1	1	\$125.00
832-EX3CQ	Ductile Iron Extension Adapter - 2" Min - 3-3/8" Max	BI	1	1	\$120.00
832-S3CQ	Two Adjustment Shims, Two 3/4" Screws	BI	1	10	\$22.00
835-2CQ	Trapshield™ For 2" Drain Outlet	BI	1	50	\$199.00
835-3CQ	Trapshield™ For 3" Drain Outlet	BI	1	25	\$224.00
863-FACQ	Round Aluminum Condensate Funnel w/ Screws	BI	1	12	\$168.00
863-FNCQ	Round Nikl-Brnz Condensate Funnel w/ Screws	BI	1	12	\$370.00

9" Diameter

Cast Iron - No-Hub Connection

Options: Add suffix to item no. Add price to list

S = ABS Sand Bucket: \$83.00; U = ABS Debris Bucket: \$83.00;  
 C = Cast Iron Clamping Collar: \$149.00; A = Acid-Resistant Epoxy Coated Cast Iron: \$1,100.00;  
 V = Vandal-Resistant Strainer (1): \$68.00; W = Stainless Steel Debris Basket: \$180.00;  
 F = Round Nickel-Bronze Condensate Funnel: \$370.00; FA = Round Aluminum Condensate Funnel: \$168.00;  
 FO = Oval Nickel-Bronze Condensate Funnel: \$815.00; 6 = ABS Flat Strainer for Drain Outlet (2): \$68.00;

1: Not available for drains with cast iron strainers 2: Not available for 6" drains

Item Number	Item Description	Pkg Type	Min Qty	Case Qty	Price
<b>NICKEL-BRONZE RING &amp; STRAINER</b>					
860-22N	2" No-Hub - 10" Rnd Grate	Bl	1	1	\$1,420.00
860-23N	3" No-Hub - 10" Rnd Grate	Bl	1	1	\$1,420.00
860-24N	4" No-Hub - 10" Rnd Grate	Bl	1	1	\$1,420.00
860-26N	6" No-Hub - 10" Rnd Grate	Bl	1	1	\$1,420.00
<b>STAINLESS STEEL RING &amp; STRAINER</b>					
860-22Z	2" No-Hub - 10" Rnd Grate	Bl	1	1	\$1,420.00
860-23Z	3" No-Hub - 10" Rnd Grate	Bl	1	1	\$1,420.00
860-24Z	4" No-Hub - 10" Rnd Grate	Bl	1	1	\$1,420.00
860-26Z	6" No-Hub - 10" Rnd Grate	Bl	1	1	\$1,420.00
<b>CAST IRON STRAINER</b>					
860-22I	2" No-Hub - 9-1/4" Rnd Grate	Bl	1	1	\$636.00
860-23I	3" No-Hub - 9-1/4" Rnd Grate	Bl	1	1	\$636.00
860-24I	4" No-Hub - 9-1/4" Rnd Grate	Bl	1	1	\$636.00
860-26I	6" No-Hub - 9-1/4" Rnd Grate	Bl	1	1	\$636.00



860-22N



860-23Z



860-22I

9" Diameter

Cast Iron - Push-Joint Connection

Options: Add suffix to item no. Add price to list

S = ABS Sand Bucket: \$83.00; U = ABS Debris Bucket: \$83.00;  
 C = Cast iron Clamping Collar: \$149.00; A = Acid-Resistant Epoxy Coated Cast Iron: \$1,100.00;  
 V = Vandal-Resistant Strainer (1): \$68.00; W = Stainless Steel Debris Basket: \$180.00;  
 F = Round Nickel-Bronze Condensate Funnel: \$370.00; FA = Round Aluminum Condensate Funnel: \$168.00;  
 FO = Oval Nickel-Bronze Condensate Funnel: \$815.00; 6 = ABS Flat Strainer for Drain Outlet: \$68.00;  
 P = Push-Joint Gasket to fit Sch. 40 Pipe (2): \$25.00;

1: Not available for drains with cast iron strainers 2: For drains with 3" and 4" push-joint connections

Item Number	Item Description	Pkg Type	Min Qty	Case Qty	Price
<b>NICKEL-BRONZE RING &amp; STRAINER</b>					
860-62N	2" PJ Conn. - 10" Rnd Grate	Bl	1	1	\$1,420.00
860-63N	3" PJ Conn. - 10" Rnd Grate	Bl	1	1	\$1,420.00
860-64N	4" PJ Conn. - 10" Rnd Grate	Bl	1	1	\$1,420.00



860-62N

Supply

Drainage

Support

Specialties

Appendix

Supply

Drainage

Support

Specialties

Appendix



860-63Z



860-62I



860-R222I



860-Q222I

## 9" Diameter (Cont)

### Cast Iron - Push-Joint Connection

Item Number	Item Description	Pkg Type	Min Qty	Case Qty	Price
<b>STAINLESS STEEL RING &amp; STRAINER</b>					
860-62Z	2" PJ Conn. - 10" Rnd Grate	BI	1	1	\$1,420.00
860-63Z	3" PJ Conn. - 10" Rnd Grate	BI	1	1	\$1,420.00
860-64Z	4" PJ Conn. - 10" Rnd Grate	BI	1	1	\$1,420.00
<b>CAST IRON STRAINER</b>					
860-62I	2" PJ Conn. - 9-1/4" Rnd Grate	BI	1	1	\$636.00
860-63I	3" PJ Conn. - 9-1/4" Rnd Grate	BI	1	1	\$636.00
860-64I	4" PJ Conn. - 9-1/4" Rnd Grate	BI	1	1	\$636.00

## 12" Diameter

### Cast Iron - No-Hub Connection

Options: Add suffix to item no. Add price to list

9 = 90-deg. Side Outlet Connection (1): \$490.00; A = Acid-Resistant Epoxy Coated Cast Iron: \$1,100.00;

B = Sediment Bucket (2): \$220.00; C = Underdeck Clamp: \$230.00;

E = Adjustable Extension: \$690.00; T = Threaded Adjustable Extension: \$830.00;

H = Hinged Square Grate: \$650.00; X = Extra Heavy-duty Grate: \$250.00;

1: For 2" - 4" No-Hub Only 2: Not available for drains with extensions

Item Number	Item Description	Pkg Type	Min Qty	Case Qty	Price
<b>ROUND CAST IRON STRAINER</b>					
860-R222I	2" No-Hub - 12" Ring & Strainer	B	1	1	\$1,600.00
860-R223I	3" No-Hub - 12" Ring & Strainer	B	1	1	\$1,600.00
860-R224I	4" No-Hub - 12" Ring & Strainer	B	1	1	\$1,600.00
860-R226I	6" No-Hub - 12" Ring & Strainer	B	1	1	\$1,600.00
860-R228I	8" No-Hub - 12" Ring & Strainer	B	1	1	\$1,600.00
<b>ROUND CAST IRON STRAINER - NICKEL-BRONZE VENEER</b>					
860-R222IN	2" No-Hub - 12" Ring & Strainer	B	1	1	\$2,200.00
860-R223IN	3" No-Hub - 12" Ring & Strainer	B	1	1	\$2,200.00
860-R224IN	4" No-Hub - 12" Ring & Strainer	B	1	1	\$2,200.00
860-R226IN	6" No-Hub - 12" Ring & Strainer	B	1	1	\$2,200.00
860-R228IN	8" No-Hub - 12" Ring & Strainer	B	1	1	\$2,200.00
<b>SQUARE CAST IRON STRAINER</b>					
860-Q222I	2" No-Hub - 12" Ring & Strainer	B	1	1	\$1,860.00
860-Q223I	3" No-Hub - 12" Ring & Strainer	B	1	1	\$1,860.00
860-Q224I	4" No-Hub - 12" Ring & Strainer	B	1	1	\$1,860.00
860-Q226I	6" No-Hub - 12" Ring & Strainer	B	1	1	\$1,860.00
860-Q228I	8" No-Hub - 12" Ring & Strainer	B	1	1	\$1,860.00
<b>SQUARE CAST IRON STRAINER - NICKEL-BRONZE VENEER</b>					
860-Q222IN	2" No-Hub - 12" Ring & Strainer	B	1	1	\$2,800.00
860-Q223IN	3" No-Hub - 12" Ring & Strainer	B	1	1	\$2,800.00
860-Q224IN	4" No-Hub - 12" Ring & Strainer	B	1	1	\$2,800.00
860-Q226IN	6" No-Hub - 12" Ring & Strainer	B	1	1	\$2,800.00
860-Q228IN	8" No-Hub - 12" Ring & Strainer	B	1	1	\$2,800.00



**12" Diameter**

**Cast Iron - Push-Joint Connection**

**Options:** Add suffix to item no. Add price to list

**9** = 90-deg. Side Outlet Connection (1): \$490.00; **A** = Acid-Resistant Epoxy Coated Cast Iron: \$1,100.00;

**B** = Sediment Bucket (2): \$220.00; **C** = Underdeck Clamp: \$230.00;

**E** = Adjustable Extension: \$690.00; **T** = Threaded Adjustable Extension: \$830.00;

**H** = Hinged Square Grate: \$650.00; **X** = Extra Heavy-duty Grate: \$250.00;

1: For 2" - 4" No-Hub Only 2: Not available for drains with extensions



860-R262I



860-Q262I

Item Number	Item Description	Pkg Type	Min Qty	Case Qty	Price
<b>ROUND CAST IRON STRAINER</b>					
860-R262I	2" PJ Conn. - 12" Ring & Strainer	B	1	1	\$1,575.00
860-R263I	3" PJ Conn. - 12" Ring & Strainer	B	1	1	\$1,600.00
860-R264I	4" PJ Conn. - 12" Ring & Strainer	B	1	1	\$1,600.00
860-R266I	6" PJ Conn. - 12" Ring & Strainer	B	1	1	\$1,600.00
<b>ROUND CAST IRON STRAINER - NICKEL-BRONZE VENEER</b>					
860-R262IN	2" PJ Conn. - 12" Ring & Strainer	B	1	1	\$2,200.00
860-R263IN	3" PJ Conn. - 12" Ring & Strainer	B	1	1	\$2,200.00
860-R264IN	4" PJ Conn. - 12" Ring & Strainer	B	1	1	\$2,200.00
860-R266IN	6" PJ Conn. - 12" Ring & Strainer	B	1	1	\$2,200.00
<b>SQUARE CAST IRON STRAINER</b>					
860-Q262I	2" PJ Conn. - 12" Ring & Strainer	B	1	1	\$1,860.00
860-Q263I	3" PJ Conn. - 12" Ring & Strainer	B	1	1	\$1,860.00
860-Q264I	4" PJ Conn. - 12" Ring & Strainer	B	1	1	\$1,860.00
860-Q266I	6" PJ Conn. - 12" Ring & Strainer	B	1	1	\$1,860.00
<b>SQUARE CAST IRON STRAINER - NICKEL-BRONZE VENEER</b>					
860-Q262IN	2" PJ Conn. - 12" Ring & Strainer	B	1	1	\$2,800.00
860-Q263IN	3" PJ Conn. - 12" Ring & Strainer	B	1	1	\$2,800.00
860-Q264IN	4" PJ Conn. - 12" Ring & Strainer	B	1	1	\$2,800.00
860-Q266IN	6" PJ Conn. - 12" Ring & Strainer	B	1	1	\$2,800.00

**Stainless Steel**

**No-Hub Connection**

Item Number	Item Description	Pkg Type	Min Qty	Case Qty	Price
<b>DRAINS</b>					
860-3SS	3" No-Hub - 6-3/4" Rnd Grate	BI	1	1	\$3,800.00
860-4SS	4" No-Hub - 8-7/8" Rnd Grate	BI	1	1	\$3,800.00
<b>ACCESSORIES</b>					
860-3SSS	6-3/4" Rnd Grate	B	1	1	\$1,000.00
860-4SSS	8-7/8" Rnd Grate	BI	1	1	\$1,000.00
860-4SSU	Debris Bucket For 860-4SS	BI	1	1	\$300.00



860-3SS



860-3SSS

Supply

Drainage

Support

Specialties

Appendix

Supply

Drainage

Support

Specialties

Appendix



862-45LNR



862-45LNQ



862-47LNRE

## Adjustable Floor Drain Head

### Nickel-Bronze - MIP Thread Connection

**Options:** Add suffix to item no. Add price to list  
**B** = Sediment Bucket: \$105.00;

Item Number	Item Description	Pkg Type	Min Qty	Case Qty	Price
<b>ROUND STRAINER</b>					
862-410LNR	4" MIP - 10" Nikl-Brnz Ring & Strainer	BI	1	8	\$1,030.00
862-45LNR	4" MIP - 5" Nikl-Brnz Ring & Strainer	BI	1	20	\$330.00
862-46LNR	4" MIP - 6" Nikl-Brnz Ring & Strainer	BI	1	20	\$430.00
862-47LNR	4" MIP - 7" Nikl-Brnz Ring & Strainer	BI	1	12	\$630.00
862-48LNR	4" MIP - 8" Nikl-Brnz Ring & Strainer	BI	1	8	\$730.00
<b>SQUARE STRAINER</b>					
862-410LNQ	4" MIP - 10" Nikl-Brnz Ring & Strainer	BI	1	4	\$1,330.00
862-45LNQ	4" MIP - 5" Nikl-Brnz Ring & Strainer	BI	1	20	\$450.00
862-46LNQ	4" MIP - 6" Nikl-Brnz Ring & Strainer	BI	1	16	\$550.00
862-47LNQ	4" MIP - 7" Nikl-Brnz Ring & Strainer	BI	1	12	\$730.00
862-48LNQ	4" MIP - 8" Nikl-Brnz Ring & Strainer	BI	1	8	\$1,030.00
<b>ACCESSORIES</b>					
862-EX4	4" Threaded Extension Adapter - MIP X FIP	B	1	16	\$120.00

## Adjustable Floor Drain Head

### Nickel-Bronze Extended Rim - MIP Thread Connection

**Options:** Add suffix to item no. Add price to list  
**B** = Sediment Bucket: \$105.00;

Item Number	Item Description	Pkg Type	Min Qty	Case Qty	Price
<b>ROUND EXTENDED RIM</b>					
862-410LNRE	4" MIP - 10" Nikl-Brnz Ring & Strainer w/ Extended Rim	BI	1	8	\$1,330.00
862-47LNRE	4" MIP - 7" Nikl-Brnz Ring & Strainer w/ Extended Rim	BI	1	8	\$1,130.00
<b>ACCESSORIES</b>					
862-EX4	4" Threaded Extension Adapter - MIP X FIP	B	1	16	\$120.00

## Adjustable Floor Drain Head

### Stainless Steel - MIP Thread Connection

**Options:** Add suffix to item no. Add price to list  
**B** = Sediment Bucket: \$105.00;

Item Number	Item Description	Pkg Type	Min Qty	Case Qty	Price
<b>ROUND STRAINER</b>					
862-45LSR	4" MIP - 5" Stnls Steel Ring & Strainer	BI	1	24	\$830.00
862-46LSR	4" MIP - 6" Stnls Steel Ring & Strainer	BI	1	20	\$1,080.00
<b>SQUARE STRAINER</b>					
862-45LSQ	4" MIP - 5" Stnls Steel Ring & Strainer	BI	1	20	\$900.00
862-46LSQ	4" MIP - 6" Stnls Steel Ring & Strainer	BI	1	16	\$1,170.00
<b>ACCESSORIES</b>					
862-EX4	4" Threaded Extension Adapter - MIP X FIP	B	1	16	\$120.00



862-45LSR



862-45LSQ

## Adjustable Floor Drain Head

### Cast Iron - MIP Thread Connection

**Options:** Add suffix to item no. Add price to list  
**B** = Sediment Bucket: \$105.00;

Item Number	Item Description	Pkg Type	Min Qty	Case Qty	Price
<b>ROUND CAST IRON RING &amp; STRAINER</b>					
862-47LI	4" MIP - 7" Ductile Iron Ring & Strainer	BI	1	1	\$430.00
862-49LI	4" MIP - 9" Ductile Iron Ring & Strainer	BI	1	1	\$630.00
<b>ROUND CAST IRON RING &amp; STRAINER - NICKEL-BRONZE VENEER</b>					
862-47LIN	4" MIP - 7" Ductile Iron Ring & Strainer w/ NB Veneer	BI	1	4	\$630.00
862-49LIN	4" MIP - 9" Ductile Iron Ring & Strainer w/ NB Veneer	BI	1	1	\$980.00
<b>SQUARE CAST IRON RING &amp; STRAINER</b>					
862-49LIQ	4" MIP - 9" Ductile Iron Ring & Strainer	BI	1	1	\$830.00
<b>SQUARE CAST IRON RING &amp; STRAINER - NICKEL-BRONZE VENEER</b>					
862-49LINQ		BI	1	1	\$1,180.00
<b>ACCESSORIES</b>					
862-EX4	4" Threaded Extension Adapter - MIP X FIP	B	1	16	\$120.00



862-47LI



862-47LIN

## TrapShield™

### Trap Protection Device

Item Number	Item Description	Pkg Type	Min Qty	Case Qty	Price
835-2CQ	Trapshield™ For 2" Drain Outlet	BI	1	50	\$199.00
835-35CQ	Trapshield™ For 3-1/2" Drain Outlet	BI	1	25	\$224.00
835-3CQ	Trapshield™ For 3" Drain Outlet	BI	1	25	\$224.00
835-4CQ	Trapshield™ For 4" Drain Outlet	BI	1	20	\$265.00



835-3CQ

Supply

Drainage

Support

Specialties

Appendix



836-2



862-B23



862-B63



842-221



858-64L

## DeckAnchor™ Fixture Mounting Fitting

### Cast Iron - No-Hub Connection

Item Number	Item Description	Pkg Type	Min Qty	Case Qty	Price
836-2	DeckAnchor™ 2" No-Hub	BI	1	1	\$394.00
836-3	DeckAnchor™ 3" No-Hub	BI	1	1	\$424.00
836-4	DeckAnchor™ 4" No-Hub	BI	1	1	\$453.00
836-6	DeckAnchor™ 6" No-Hub	BI	1	1	\$485.00

## Floor Drain Adapters

### Flashing Drain Adapters - 4" FIP Thread

Item Number	Item Description	Pkg Type	Min Qty	Case Qty	Price
<b>CAST IRON - NO-HUB CONNECTION</b>					
862-B22	4" FIP x 2" No-Hub	B	1	1	\$270.00
862-B23	4" FIP x 3" No-Hub	B	1	1	\$270.00
862-B24	4" FIP x 4" No-Hub	B	1	1	\$270.00
<b>CAST IRON - PUSH-JOINT CONNECTION</b>					
862-B62	4" FIP x 2" PJ Conn.	B	1	1	\$270.00
862-B63	4" FIP x 3" PJ Conn.	B	1	1	\$270.00
862-B64	4" FIP x 4" PJ Conn.	B	1	1	\$270.00

## Floor Drain Adapters

### No-Hub Adapters

Item Number	Item Description	Pkg Type	Min Qty	Case Qty	Price
<b>CAST IRON - FIP X NO-HUB ADAPTER</b>					
842-241	4" Cast Iron No-Hub w/ 4" FIP Thread	BI	1	2	\$57.00

## Floor Drain Adapters

### Push-Joint Adapters

**Options:** Add suffix to item no. Add price to list  
 P = Push-joint gasket to fit Sc. 40 ABS/PVC pipe: \$7.50;

Item Number	Item Description	Pkg Type	Min Qty	Case Qty	Price
<b>CAST IRON - FIP X PUSH-JOINT ADAPTER</b>					
858-63L	3" PJ Conn. w/ 3" FIP Thread	BI	1	4	\$45.12
858-64L	4" PJ Conn. w/ 4" FIP Thread	BI	1	4	\$158.00

**Floor Drain Adapters**

**Extension Adapter**

Item Number	Item Description	Pkg Type	Min Qty	Case Qty	Price
<b>CAST IRON - MIP X FIP HEAD EXTENSION</b>					
862-EX4	4" Threaded Extension Adapter - MIP X FIP	B	1	16	\$120.00



862-EX4

**Condensate Funnels**

Item Number	Item Description	Pkg Type	Min Qty	Case Qty	Price
<b>ROUND 4"</b>					
863-FACQ	Round Aluminum Condensate Funnel w/ Screws	BI	1	12	\$168.00
863-FNCQ	Round Nikl-Brnz Condensate Funnel w/ Screws	BI	1	12	\$370.00
<b>OVAL 4" X 9"</b>					
863-FNOCQ	Oval Nikl-Brnz Condensate Funnel w/ Screws	BI	1	12	\$815.00



863-FACQ

Supply

Drainage

Support

Specialties

Appendix



# Specification Floor Sinks

**Cast Iron Square Floor Sinks**

**Cast Iron Round Floor Sinks**

**Stainless Steel Square Floor Sinks**

**Stainless Steel Round Floor Sinks**



Cast iron floor sinks are enamel coated for resistance to abrasion, acids and corrosion.



**861-Q2226**  
Page 273



**861-QF2226**  
Page 273



**861-Q2328**  
Page 274



**861-QF2328**  
Page 274



**861-Q2221**  
Page 275



**861-QF2221**  
Page 275



**861-Q2286**  
Page 276



**861-QF2286**  
Page 276



**861-R2286**  
Page 278



**861-RF2286**  
Page 278



**861-R2228**  
Page 277



**861-RF2228**  
Page 277



**861-SQ2428**  
Page 279



**860-4SS**  
Page 280



12" x 12" x 6"

Cast Iron - No-Hub Connection

Options: Add suffix to item no. Add price to list

2 = Open-Half Grate (1): N/C; 3 = Open-Quarter Grate (1): N/C;  
 B = Aluminum Bucket: \$348.00; C = Clamping Collar (2): \$300.00;  
 T = 1/2" Trap Primer Connection: \$213.00;

1: For sinks with grates only 2: For sinks with anchor flange



861-Q2226



861-QF2226



861-GNQ2T



861-TA22

Item Number	Item Description	Pkg Type	Min Qty	Case Qty	Price
<b>FLOOR SINKS WITH AL DOME BOTTOM STRAINER</b>					
861-Q2226	2" No-Hub - No Grate	B	1	1	\$1,100.00
<b>861-Q2226A</b>	2" No-Hub - ARE Grate	B	1	1	\$1,318.00
<b>861-Q2226N</b>	2" No-Hub - Nikl-Brnz Hinged Grate	B	1	1	\$2,600.00
861-Q2326	3" No-Hub - No Grate	B	1	1	\$1,100.00
<b>861-Q2326A</b>	3" No-Hub - ARE Grate	B	1	1	\$1,318.00
<b>861-Q2326N</b>	3" No-Hub - Nikl-Brnz Hinged Grate	B	1	1	\$2,600.00
861-Q2426	4" No-Hub - No Grate	B	1	1	\$1,100.00
<b>861-Q2426A</b>	4" No-Hub - ARE Grate	B	1	1	\$1,318.00
<b>861-Q2426N</b>	4" No-Hub - Nikl-Brnz Hinged Grate	B	1	1	\$2,600.00
861-QF2226	2" No-Hub - No Grate, w/ Flange	B	1	1	\$1,200.00
<b>861-QF2226A</b>	2" No-Hub - ARE Grate, w/ Flange	B	1	1	\$1,418.00
<b>861-QF2226N</b>	2" No-Hub - Nikl-Brnz Hinged Grate, w/ Flange	B	1	1	\$2,700.00
861-QF2326	3" No-Hub - No Grate, w/ Flange	B	1	1	\$1,200.00
<b>861-QF2326A</b>	3" No-Hub - ARE Grate, w/ Flange	B	1	1	\$1,418.00
<b>861-QF2326N</b>	3" No-Hub - Nikl-Brnz Hinged Grate, w/ Flange	B	1	1	\$2,700.00
861-QF2426	4" No-Hub - No Grate, w/ Flange	B	1	1	\$1,200.00
<b>861-QF2426A</b>	4" No-Hub - ARE Grate, w/ Flange	B	1	1	\$1,418.00
<b>861-QF2426N</b>	4" No-Hub - Nikl-Brnz Hinged Grate, w/ Flange	B	1	1	\$2,700.00
<b>ACCESSORIES</b>					
<b>861-BQ2</b>	Aluminum Bucket	B	1	1	\$348.00
<b>861-CQ2</b>	Clamping Collar	B	1	1	\$300.00
861-GAQ2F	A.R.E. Full Grate	B	1	6	\$218.00
861-GAQ2H	A.R.E. Open-Half Grate	B	1	6	\$218.00
861-GAQ2T	A.R.E. Open-Quarter Grate	B	1	6	\$218.00
861-GNQ2F	Nickl-Brnz Full Grate - Hinged	B	1	1	\$1,500.00
861-GNQ2H	Nickl-Brnz Open-Half Grate - Hinged	B	1	1	\$1,500.00
861-GNQ2T	Nickl-Brnz Open-Quarter Grate	B	1	1	\$1,500.00
<b>863-FACQ</b>	Round Aluminum Condensate Funnel w/ Screws	Bl	1	12	\$168.00
<b>863-FNCQ</b>	Round Nikl-Brnz Condensate Funnel w/ Screws	Bl	1	12	\$370.00
<b>863-FNOCQ</b>	Oval Nikl-Brnz Condensate Funnel w/ Screws	Bl	1	12	\$815.00
<b>TRAP PRIMER ADAPTER</b>					
861-TA22	2" No-Hub - 1/2" FIP	B	1	1	\$213.00
861-TA23	3" No-Hub - 1/2" FIP	B	1	1	\$213.00
861-TA24	4" No-Hub - 1/2" FIP	B	1	1	\$213.00

Supply

Drainage

Support

Specialties

Appendix

**12" x 12" x 8"**

**Cast Iron - No-Hub Connection**

**Options:** Add suffix to item no. Add price to list  
**2** = Open-Half Grate (1): N/C; **3** = Open-Quarter Grate (1): N/C;  
**B** = Aluminum Bucket: \$348.00; **C** = Clamping Collar (2): \$300.00;  
**T** = 1/2" Trap Primer Connection: \$213.00;

1: For sinks with grates only 2: For sinks with anchor flange

Item Number	Item Description	Pkg Type	Min Qty	Case Qty	Price
<b>FLOOR SINKS WITH AL DOME BOTTOM STRAINER</b>					
861-Q2228	2" No-Hub - No Grate	B	1	1	\$1,200.00
<b>861-Q2228A</b>	2" No-Hub - ARE Grate	B	1	1	\$1,418.00
<b>861-Q2228N</b>	2" No-Hub - Nikl-Brnz Hinged Grate	B	1	1	\$2,700.00
861-Q2328	3" No-Hub - No Grate	B	1	1	\$1,200.00
<b>861-Q2328A</b>	3" No-Hub - ARE Grate	B	1	1	\$1,418.00
<b>861-Q2328N</b>	3" No-Hub - Nikl-Brnz Hinged Grate	B	1	1	\$2,700.00
861-Q2428	4" No-Hub - No Grate	B	1	1	\$1,200.00
<b>861-Q2428A</b>	4" No-Hub - ARE Grate	B	1	1	\$1,418.00
<b>861-Q2428N</b>	4" No-Hub - Nikl-Brnz Hinged Grate	B	1	1	\$2,700.00
861-QF2228	2" No-Hub - No Grate, w/ Flange	B	1	1	\$1,300.00
<b>861-QF2228A</b>	2" No-Hub - ARE Grate, w/ Flange	B	1	1	\$1,518.00
<b>861-QF2228N</b>	2" No-Hub - Nikl-Brnz Grate, w/ Flange	B	1	1	\$2,800.00
861-QF2328	3" No-Hub - No Grate, w/ Flange	B	1	1	\$1,300.00
<b>861-QF2328A</b>	3" No-Hub - ARE Grate, w/ Flange	B	1	1	\$1,518.00
<b>861-QF2328N</b>	3" No-Hub - Nikl-Brnz Hinged Grate, w/ Flange	B	1	1	\$2,800.00
861-QF2428	4" No-Hub - No Grate, w/ Flange	B	1	1	\$1,300.00
<b>861-QF2428A</b>	4" No-Hub - ARE Grate, w/ Flange	B	1	1	\$1,518.00
<b>861-QF2428N</b>	4" No-Hub - Nikl-Brnz Hinged Grate, w/ Flange	B	1	1	\$2,800.00
<b>ACCESSORIES</b>					
<b>861-BQ2</b>	Aluminum Bucket	B	1	1	\$348.00
<b>861-CQ2</b>	Clamping Collar	B	1	1	\$300.00
861-GAQ2F	A.R.E. Full Grate	B	1	6	\$218.00
861-GAQ2H	A.R.E. Open-Half Grate	B	1	6	\$218.00
861-GAQ2T	A.R.E. Open-Quarter Grate	B	1	6	\$218.00
861-GNQ2F	Nickl-Brnz Full Grate - Hinged	B	1	1	\$1,500.00
861-GNQ2H	Nickl-Brnz Open-Half Grate - Hinged	B	1	1	\$1,500.00
861-GNQ2T	Nickl-Brnz Open-Quarter Grate	B	1	1	\$1,500.00
<b>863-FACQ</b>	Round Aluminum Condensate Funnel w/ Screws	BI	1	12	\$168.00
<b>863-FNCQ</b>	Round Nikl-Brnz Condensate Funnel w/ Screws	BI	1	12	\$370.00
<b>863-FNOCQ</b>	Oval Nikl-Brnz Condensate Funnel w/ Screws	BI	1	12	\$815.00
<b>TRAP PRIMER ADAPTER</b>					
861-TA22	2" No-Hub - 1/2" FIP	B	1	1	\$213.00
861-TA23	3" No-Hub - 1/2" FIP	B	1	1	\$213.00
861-TA24	4" No-Hub - 1/2" FIP	B	1	1	\$213.00



861-Q2328



861-QF2228



861-GNQ2H



861-TA23

Supply

Drainage

Support

Specialties

Appendix

12" x 12" x 10"

Cast Iron - No-Hub Connection

Options: Add suffix to item no. Add price to list

2 = Open-Half Grate (1): N/C; 3 = Open-Quarter Grate (1): N/C;  
 B = Aluminum Bucket: \$348.00; C = Clamping Collar (2): \$300.00;  
 T = 1/2" Trap Primer Connection: \$213.00;

1: For sinks with grates only 2: For sinks with anchor flange

Item Number	Item Description	Pkg Type	Min Qty	Case Qty	Price
<b>FLOOR SINKS WITH AL DOME BOTTOM STRAINER</b>					
861-Q2221	2" No-Hub - No Grate	B	1	1	\$1,300.00
<b>861-Q2221A</b>	2" No-Hub - ARE Grate	B	1	1	\$1,518.00
<b>861-Q2221N</b>	2" No-Hub - Nikl-Brnz Hinged Grate	B	1	1	\$2,800.00
861-Q2321	3" No-Hub - No Grate	B	1	1	\$1,300.00
<b>861-Q2321A</b>	3" No-Hub - ARE Grate	B	1	1	\$1,518.00
<b>861-Q2321N</b>	3" No-Hub - Nikl-Brnz Hinged Grate	B	1	1	\$2,800.00
861-Q2421	4" No-Hub - No Grate	B	1	1	\$1,300.00
<b>861-Q2421A</b>	4" No-Hub - ARE Grate	B	1	1	\$1,518.00
<b>861-Q2421N</b>	4" No-Hub - Nikl-Brnz Hinged Grate	B	1	1	\$2,800.00
861-QF2221	2" No-Hub - No Grate, w/ Flange	B	1	1	\$1,400.00
<b>861-QF2221A</b>	2" No-Hub - ARE Grate, w/ Flange	B	1	1	\$1,618.00
<b>861-QF2221N</b>	2" No-Hub - Nikl-Brnz Hinged Grate, w/ Flange	B	1	1	\$2,900.00
861-QF2321	3" No-Hub - No Grate, w/ Flange	B	1	1	\$1,400.00
<b>861-QF2321A</b>	3" No-Hub - ARE Grate, w/ Flange	B	1	1	\$1,618.00
<b>861-QF2321N</b>	3" No-Hub - Nikl-Brnz Hinged Grate, w/ Flange	B	1	1	\$2,900.00
861-QF2421	4" No-Hub - No Grate, w/ Flange	B	1	1	\$1,400.00
<b>861-QF2421A</b>	4" No-Hub - ARE Grate, w/ Flange	B	1	1	\$1,618.00
<b>861-QF2421N</b>	4" No-Hub - Nikl-Brnz Hinged Grate, w/ Flange	B	1	1	\$2,900.00
<b>ACCESSORIES</b>					
<b>861-BQ2</b>	Aluminum Bucket	B	1	1	\$348.00
<b>861-CQ2</b>	Clamping Collar	B	1	1	\$300.00
861-GAQ2F	A.R.E. Full Grate	B	1	6	\$218.00
861-GAQ2H	A.R.E. Open-Half Grate	B	1	6	\$218.00
861-GAQ2T	A.R.E. Open-Quarter Grate	B	1	6	\$218.00
861-GNQ2F	Nickl-Brnz Full Grate - Hinged	B	1	1	\$1,500.00
861-GNQ2H	Nickl-Brnz Open-Half Grate - Hinged	B	1	1	\$1,500.00
861-GNQ2T	Nickl-Brnz Open-Quarter Grate	B	1	1	\$1,500.00
<b>863-FACQ</b>	Round Aluminum Condensate Funnel w/ Screws	BI	1	12	\$168.00
<b>863-FNCQ</b>	Round Nikl-Brnz Condensate Funnel w/ Screws	BI	1	12	\$370.00
<b>863-FNOQ</b>	Oval Nikl-Brnz Condensate Funnel w/ Screws	BI	1	12	\$815.00
<b>TRAP PRIMER ADAPTER</b>					
861-TA22	2" No-Hub - 1/2" FIP	B	1	1	\$213.00
861-TA23	3" No-Hub - 1/2" FIP	B	1	1	\$213.00
861-TA24	4" No-Hub - 1/2" FIP	B	1	1	\$213.00



861-Q2221



861-QF2221

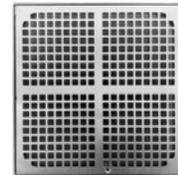

861-GNQ2F



861-TA24

Supply

Drainage

Support

Specialties

Appendix

**8" x 8" x 6"**

**Cast Iron - No-Hub Connection**

**Options:** Add suffix to item no. Add price to list  
**2** = Open-Half Grate (1): N/C; **3** = Open-Quarter Grate (1): N/C;  
**B** = Aluminum Bucket: \$250.00; **C** = Clamping Collar (2): \$202.00;  
**T** = 1/2" Trap Primer Connection: \$213.00;

1: For sinks with grates only 2: For sinks with anchor flange



861-QA286



861-QF2286



861-GAQ8H



861-TA22

Item Number	Item Description	Pkg Type	Min Qty	Case Qty	Price
<b>FLOOR SINKS WITH AL DOME BOTTOM STRAINER</b>					
861-Q2286	2" No-Hub - No Grate	B	1	1	\$1,000.00
<b>861-Q2286A</b>	2" No-Hub - ARE Grate	B	1	1	\$1,218.00
<b>861-Q2286N</b>	2" No-Hub - Nikl-Brnz Grate	B	1	1	\$1,900.00
861-Q2386	3" No-Hub - No Grate	B	1	1	\$1,000.00
<b>861-Q2386A</b>	3" No-Hub - ARE Grate	B	1	1	\$1,218.00
<b>861-Q2386N</b>	3" No-Hub - Nikl-Brnz Grate	B	1	1	\$1,900.00
861-Q2486	4" No-Hub - No Grate	B	1	1	\$1,000.00
<b>861-Q2486A</b>	4" No-Hub - ARE Grate	B	1	1	\$1,218.00
<b>861-Q2486N</b>	4" No-Hub - Nikl-Brnz Grate	B	1	1	\$1,900.00
861-QF2286	2" No-Hub - No Grate, w/ Flange	B	1	1	\$1,100.00
<b>861-QF2286A</b>	2" No-Hub - ARE Grate, w/ Flange	B	1	1	\$1,318.00
<b>861-QF2286N</b>	2" No-Hub - Nikl-Brnz Grate, w/ Flange	B	1	1	\$2,000.00
861-QF2386	3" No-Hub - No Grate, w/ Flange	B	1	1	\$1,100.00
<b>861-QF2386A</b>	3" No-Hub - ARE Grate, w/ Flange	B	1	1	\$1,318.00
<b>861-QF2386N</b>	3" No-Hub - Nikl-Brnz Grate, w/ Flange	B	1	1	\$2,000.00
861-QF2486	4" No-Hub - No Grate, w/ Flange	B	1	1	\$1,100.00
<b>861-QF2486A</b>	4" No-Hub - ARE Grate, w/ Flange	B	1	1	\$1,318.00
<b>861-QF2486N</b>	4" No-Hub - Nikl-Brnz Grate, w/ Flange	B	1	1	\$2,000.00
<b>ACCESSORIES</b>					
<b>861-BQ8</b>	Aluminum Bucket	B	1	1	\$250.00
<b>861-CQ8</b>	Clamping Collar	BI	8	8	\$202.00
861-GAQ8F	A.R.E. Full Grate	B	1	6	\$218.00
861-GAQ8H	A.R.E. Open-Half Grate	B	1	6	\$218.00
861-GAQ8T	A.R.E. Open-Quarter Grate	B	1	6	\$218.00
861-GNQ8F	Nickl-Brnz Full Grate	B	1	1	\$900.00
861-GNQ8H	Nickl-Brnz Open-Half Grate	B	1	1	\$900.00
861-GNQ8T	Nickl-Brnz Open-Quarter Grate	B	1	1	\$900.00
<b>863-FACQ</b>	Round Aluminum Condensate Funnel w/ Screws	BI	1	12	\$168.00
<b>863-FNCQ</b>	Round Nikl-Brnz Condensate Funnel w/ Screws	BI	1	12	\$370.00
<b>863-FNOCQ</b>	Oval Nikl-Brnz Condensate Funnel w/ Screws	BI	1	12	\$815.00
<b>TRAP PRIMER ADAPTER</b>					
861-TA22	2" No-Hub - 1/2" FIP	B	1	1	\$213.00
861-TA23	3" No-Hub - 1/2" FIP	B	1	1	\$213.00
861-TA24	4" No-Hub - 1/2" FIP	B	1	1	\$213.00

Supply

Drainage

Support

Specialties

Appendix

12" x 8"

Cast Iron - No-Hub Connection

Options: Add suffix to item no. Add price to list

2 = Open-Half Grate (1): N/C; 3 = Open-Quarter Grate (1): N/C;

B = Aluminum Bucket: \$348.00; C = Clamping Collar (2): \$250.00;

T = 1/2" Trap Primer Connection: \$213.00;

1: For sinks with grates only 2: For sinks with anchor flange

Item Number	Item Description	Pkg Type	Min Qty	Case Qty	Price
<b>FLOOR SINKS WITH AL DOME BOTTOM STRAINER</b>					
861-R2228	2" No-Hub - No Grate	B	1	1	\$1,200.00
<b>861-R2228A</b>	2" No-Hub - ARE Grate	B	1	1	\$1,500.00
<b>861-R2228N</b>	2" No-Hub - Nikl-Brnz Grate	B	1	1	\$2,700.00
861-R2328	3" No-Hub - No Grate	B	1	1	\$1,200.00
<b>861-R2328A</b>	3" No-Hub - ARE Grate	B	1	1	\$1,500.00
<b>861-R2328N</b>	3" No-Hub - Nikl-Brnz Grate	B	1	1	\$2,700.00
861-R2428	4" No-Hub - No Grate	B	1	1	\$1,200.00
<b>861-R2428A</b>	4" No-Hub - ARE Grate	B	1	1	\$1,500.00
<b>861-R2428N</b>	4" No-Hub - Nikl-Brnz Grate	B	1	1	\$2,700.00
861-RF2228	2" No-Hub - No Grate, w/ Flange	B	1	1	\$1,300.00
<b>861-RF2228A</b>	2" No-Hub - ARE Grate, w/ Flange	B	1	1	\$1,600.00
<b>861-RF2228N</b>	2" No-Hub - Nikl-Brnz Grate, w/ Flange	B	1	1	\$2,800.00
861-RF2328	3" No-Hub - No Grate, w/ Flange	B	1	1	\$1,300.00
<b>861-RF2328A</b>	3" No-Hub - ARE Grate, w/ Flange	B	1	1	\$1,600.00
<b>861-RF2328N</b>	3" No-Hub - Nikl-Brnz Grate, w/ Flange	B	1	1	\$2,800.00
861-RF2428	4" No-Hub - No Grate, w/ Flange	B	1	1	\$1,300.00
<b>861-RF2428A</b>	4" No-Hub - ARE Grate, w/ Flange	B	1	1	\$1,600.00
<b>861-RF2428N</b>	4" No-Hub - Nikl-Brnz Grate, w/ Flange	B	1	1	\$2,800.00
<b>ACCESSORIES</b>					
<b>861-BR2</b>	Aluminum Bucket	B	1	1	\$348.00
<b>861-CR2</b>	Collar Clamp	B	1	1	\$300.00
861-GAR2F	A.R.E. Full Grate	B	1	6	\$218.00
861-GAR2H	A.R.E. Open-Half Grate	B	1	6	\$218.00
861-GNR2F	Nickl-Brnz Full Grate	B	1	1	\$1,500.00
861-GNR2H	Nickl-Brnz Open-Half Grate	B	1	1	\$1,500.00
861-GNR2T	Nickl-Brnz Open-Quarter Grate	B	1	1	\$1,500.00
<b>863-FACQ</b>	Round Aluminum Condensate Funnel w/ Screws	Bl	1	12	\$168.00
<b>863-FNCQ</b>	Round Nikl-Brnz Condensate Funnel w/ Screws	Bl	1	12	\$370.00
<b>863-FNOCQ</b>	Oval Nikl-Brnz Condensate Funnel w/ Screws	Bl	1	12	\$815.00
<b>TRAP PRIMER ADAPTER</b>					
861-TA22	2" No-Hub - 1/2" FIP	B	1	1	\$213.00
861-TA23	3" No-Hub - 1/2" FIP	B	1	1	\$213.00
861-TA24	4" No-Hub - 1/2" FIP	B	1	1	\$213.00



861-R2228



861-RF2228



Nickl-Brnz open-half grate



861-TA24

Supply

Drainage

Support

Specialties

Appendix

8" x 6"

Cast Iron - No-Hub Connection

Options: Add suffix to item no. Add price to list

2 = Open-Half Grate (1): N/C; 3 = Open-Quarter Grate (1): N/C;

B = Aluminum Bucket: \$250.00; C = Clamping Collar with Anchor Flange: \$202.00;

T = 1/2" Trap Primer Connection: \$213.00;

1: For sinks with grates only



861-R2286



861-RF2286



861-GAR8T



861-TA23

Item Number	Item Description	Pkg Type	Min Qty	Case Qty	Price
<b>FLOOR SINKS WITH AL DOME BOTTOM STRAINER</b>					
861-R2286	2" No-Hub - No Grate	B	1	1	\$1,000.00
<b>861-R2286A</b>	2" No-Hub - ARE Grate	B	1	1	\$1,218.00
<b>861-R2286N</b>	2" No-Hub - Nikl-Brnz Grate	B	1	1	\$1,800.00
861-R2386	3" No-Hub - No Grate	B	1	1	\$1,000.00
<b>861-R2386A</b>	3" No-Hub - ARE Grate	B	1	1	\$1,218.00
<b>861-R2386N</b>	3" No-Hub - Nikl-Brnz Grate	B	1	1	\$1,800.00
861-R2486	4" No-Hub - No Grate	B	1	1	\$1,000.00
<b>861-R2486A</b>	4" No-Hub - ARE Grate	B	1	1	\$1,218.00
<b>861-R2486N</b>	4" No-Hub - Nikl-Brnz Grate	B	1	1	\$1,800.00
861-RF2286	2" No-Hub - No Grate, w/ Flange	B	1	1	\$1,100.00
<b>861-RF2286A</b>	2" No-Hub - ARE Grate, w/ Flange	B	1	1	\$1,318.00
<b>861-RF2286N</b>	2" No-Hub - Nikl-Brnz Grate, w/ Flange	B	1	1	\$1,900.00
861-RF2386	3" No-Hub - No Grate, w/ Flange	B	1	1	\$1,100.00
<b>861-RF2386A</b>	3" No-Hub - ARE Grate, w/ Flange	B	1	1	\$1,318.00
<b>861-RF2386N</b>	3" No-Hub - Nikl-Brnz Grate, w/ Flange	B	1	1	\$1,900.00
861-RF2486	4" No-Hub - No Grate, w/ Flange	B	1	1	\$1,100.00
<b>861-RF2486A</b>	4" No-Hub - ARE Grate, w/ Flange	B	1	1	\$1,318.00
<b>861-RF2486N</b>	4" No-Hub - Nikl-Brnz Grate, w/ Flange	B	1	1	\$1,900.00
<b>ACCESSORIES</b>					
<b>861-BR8</b>	Aluminum Bucket	B	1	1	\$250.00
<b>861-CR8</b>	Collar Clamp	B	1	1	\$202.00
861-GAR8F	A.R.E. Full Grate	B	1	6	\$218.00
861-GAR8H	A.R.E. Open-Half Grate	B	1	6	\$218.00
861-GNR8F	Nickl-Brnz Full Grate	B	1	1	\$800.00
861-GNR8H	Nickl-Brnz Open-Half Grate	B	1	1	\$800.00
<b>863-FACQ</b>	Round Aluminum Condensate Funnel w/ Screws	BI	1	12	\$168.00
<b>863-FNCQ</b>	Round Nikl-Brnz Condensate Funnel w/ Screws	BI	1	12	\$370.00
<b>863-FNOCQ</b>	Oval Nikl-Brnz Condensate Funnel w/ Screws	BI	1	12	\$815.00
<b>TRAP PRIMER ADAPTER</b>					
861-TA22	2" No-Hub - 1/2" FIP	B	1	1	\$213.00
861-TA23	3" No-Hub - 1/2" FIP	B	1	1	\$213.00
861-TA24	4" No-Hub - 1/2" FIP	B	1	1	\$213.00

Supply

Drainage

Support

Specialties

Appendix

**12" x 12" x 8"**

**Stainless Steel No-Hub Connection**

Item Number	Item Description	Pkg Type	Min Qty	Case Qty	Price
<b>FLOOR SINKS WITH DOME BOTTOM STRAINER</b>					
861-SQ2428	4" No-Hub - No Grate	BI	1	1	\$4,100.00
<b>ACCESSORIES</b>					
861-BKQ2	Stainless Steel Debris Basket - Fits In Bottom of Sump Area	BI	1	1	\$1,600.00
861-GKQ2F	Stainless Steel Grate - 11ga. Square Perforated Pattern - Full	BI	1	1	\$1,650.00
861-GKQ2FL	Stainless Steel Grate - Heavy-Duty, High-Inflow Ladder Pattern - Full	BI	1	1	\$2,600.00
861-GKQ2FW	Stainless Steel Grate - Heavy-Duty, Heel-Resistant Wire Pattern - Full	BI	1	1	\$4,100.00
861-GKQ2H	Stainless Steel Grate - 11ga. Square Perforated Pattern - Open-Half	BI	1	1	\$1,650.00



861-SQ2428

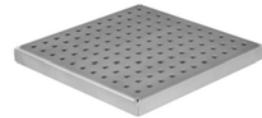

861-GKQ2F

Supply

Drainage

Support

Specialties

Appendix

Supply

Drainage

Support

Specialties

Appendix



860-4SS

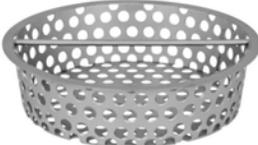

860-4SSU

## Round Floor Sinks

### Stainless Steel No-Hub Connection

Item Number	Item Description	Pkg Type	Min Qty	Case Qty	Price
<b>FLOOR SINKS</b>					
860-3SS	3" No-Hub - 6-3/4" Rnd Grate	BI	1	1	\$3,800.00
860-4SS	4" No-Hub - 8-7/8" Rnd Grate	BI	1	1	\$3,800.00
<b>ACCESSORIES</b>					
860-3SSS	6-3/4" Rnd Grate	B	1	1	\$1,000.00
860-4SSS	8-7/8" Rnd Grate	BI	1	1	\$1,000.00
860-4SSU	Debris Bucket For 860-4SS	BI	1	1	\$300.00



# Specification Roof Drains

**Roof Drains**

**Promenade Drains**

**Scupper Drains**

**Accessories**





**868-1504**  
Page 283



**868-524B**  
Page 284



**868-F524**  
Page 284



**868-I4**  
Page 285



**868-123**  
Page 286



**868-824**  
Page 286



**868-2010**  
Page 287



**868-D1503**  
Page 288



**868-D824**  
Page 290



**868-R623I**  
Page 291



**868-S4A**  
Page 292



**868-N6F**  
Page 293



**868-N4S**  
Page 293



**868-V234**  
Page 293

## 15" Roof Drain - Alpha Series

### Cast Iron - No-Hub Connection

**Options:** Add suffix to item no. Add price to list

**H** = Undermount Hardware Kit: \$119.00; **U** = Underdeck Clamp Kit: \$229.00;  
**S** = Sump Receiver: \$274.00; **E** = Adjustable Extension Assembly Kit: \$830.00;  
**W** = 2" High External Water Dam: \$290.00; **P** = 2" High Internal Water Dam: \$290.00;  
**A** = Aluminum Dome Strainer (1): \$290.00; **V** = Vandal-Resistant Dome: \$150.00;

1: In lieu of cast iron dome (standard)



868-1504

Item Number	Item Description	Pkg Type	Min Qty	Case Qty	Price
<b>ROOF DRAINS</b>					
868-1503	3" No-Hub w/ Cast Iron Dome Strainer	Bl	1	1	\$815.00
868-1504	4" No-Hub w/ Cast Iron Dome Strainer	Bl	1	1	\$815.00
868-1506	6" No-Hub w/ Cast Iron Dome Strainer	Bl	1	1	\$815.00
868-1508	8" No-Hub w/ Cast Iron Dome Strainer	Bl	1	1	\$815.00
<b>ACCESSORIES</b>					
<b>868-15AD</b>	12-1/2" Aluminum Dome Strainer	Bl	1	1	\$290.00
868-15CD	12-1/2" Cast Iron Dome Strainer	Bl	1	1	\$205.00
868-15EXT	Adjustable Extension Assembly Kit	Bl	1	1	\$830.00
868-15S	Sump Receiver - 16ga Galvanized Steel	Bl	1	1	\$274.00
868-15SH	Top Mount Hardware Kit: Angle Brackets, Thread Rod, Nuts, Washers	Bl	1	10	\$119.00
868-15U	Underdeck Clamp Kit: 4 Pieces Thread Rod, Nuts, Washers, Two Clamping Bars	Bl	1	5	\$229.00
868-15WD	External Water Dam - 2" High	Bl	1	5	\$290.00

## 15" Roof Drain - Bravo Series

### Cast Iron - No-Hub Connection

**Options:** Add suffix to item no. Add price to list

**9** = 90-deg. Side Outlet Connection (1): \$486.00; **2** = 2" High SS Perforated Extension: \$750.00;  
**4** = 4" High SS Perforated Extension: \$750.00; **D** = 6" High SS Perforated Dome Cover: \$1,750.00;  
**P** = Top Mount Sump Receiver: \$415.00; **S** = Sump Receiver: \$260.00;  
**C** = Underdeck Clamp: \$230.00; **E** = Adjustable Extension Assembly Kit: \$830.00;  
**G** = 2" High SS Perforated Gravel Guard: \$750.00; **K** = 4" High SS Perforated Gravel Guard: \$750.00;  
**H** = 4" High Internal Water Dam: \$400.00; **W** = 2" High External Water Dam: \$183.00;

1: Not available for 6" or 8" drains



868-522

Item Number	Item Description	Pkg Type	Min Qty	Case Qty	Price
<b>CAST IRON DOME</b>					
868-523	3" No-Hub w/ Cast Iron Dome Strainer	B	1	1	\$925.00
868-524	4" No-Hub w/ Cast Iron Dome Strainer	B	1	1	\$925.00
868-526	6" No-Hub w/ Cast Iron Dome Strainer	B	1	1	\$1,200.00
868-528	8" No-Hub w/ Cast Iron Dome Strainer	B	1	1	\$1,540.00

Supply

Drainage

Support

Specialties

Appendix



868-524B



868-5U

## 15" Roof Drain - Bravo Series (Cont)

### Cast Iron - No-Hub Connection

Item Number	Item Description	Pkg Type	Min Qty	Case Qty	Price
<b>POLY DOME</b>					
868-523B	3" No-Hub w/ Poly Dome Strainer	B	1	1	\$775.00
868-524B	4" No-Hub w/ Poly Dome Strainer	B	1	1	\$775.00
868-526B	6" No-Hub w/ Poly Dome Strainer	B	1	1	\$1,050.00
868-528B	8" No-Hub w/ Poly Dome Strainer	B	1	1	\$1,390.00
<b>ALUMINUM DOME</b>					
868-523A	3" No-Hub w/ Aluminum Dome Strainer	B	1	1	\$975.00
868-524A	4" No-Hub w/ Aluminum Dome Strainer	B	1	1	\$975.00
868-526A	6" No-Hub w/ Aluminum Dome Strainer	B	1	1	\$1,165.00
868-528A	8" No-Hub w/ Aluminum Dome Strainer	B	1	1	\$1,390.00
<b>ACCESSORIES</b>					
868-5AD	Aluminum Dome Strainer	B	1	1	\$250.00
868-5CD	Cast Iron Dome Strainer	BI	1	1	\$250.00
868-5EXT	Adjustable/Threaded Extension Assembly Kit	BI	1	1	\$830.00
868-5PD	ABS Dome Strainer	BI	1	1	\$150.00
868-5S	Sump Receiver - Coated Steel	BI	1	1	\$260.00
868-5S2	Double Sump Receiver Only - Coated Steel	BI	1	1	\$787.00
868-5SH	Top Mount Hardware Kit: Angle Brackets, Screws	BI	1	50	\$155.00
868-5U	Underdeck Clamp Kit: Clamping Ring, Thread Rod, Nuts, Washers	BI	1	1	\$230.00
868-5WD	External Water Dam - 2" High	BI	1	1	\$290.00

## 15" Adjustable Weir Roof Drain

### Cast Iron - No-Hub Connection



868-F524

**Options:** Add suffix to item no. Add price to list

9 = 90-deg. Side Outlet Connection (1): \$486.00; 2 = 2" High SS Perforated Extension: \$750.00;

4 = 4" High SS Perforated Extension: \$750.00; P = Top Mount Sump Receiver: \$415.00;

S = Sump Receiver: \$260.00; C = Underdeck Clamp: \$230.00;

E = Adjustable Extension Assembly Kit: \$695.00; G = 2" High SS Perforated Gravel Guard: \$750.00;

K = 4" High SS Perforated Gravel Guard: \$750.00;

1: Not available for 6" drains

Item Number	Item Description	Pkg Type	Min Qty	Case Qty	Price
<b>CAST IRON DOME</b>					
868-F523	3" No-Hub w/ Cast Iron Dome Strainer	B	1	1	\$1,650.00
868-F524	4" No-Hub w/ Cast Iron Dome Strainer	B	1	1	\$1,650.00
868-F526	6" No-Hub w/ Cast Iron Dome Strainer	B	1	1	\$1,650.00
<b>POLY DOME</b>					
868-F523B	3" No-Hub w/ Poly Dome Strainer	B	1	1	\$1,550.00
868-F524B	4" No-Hub w/ Poly Dome Strainer	B	1	1	\$1,550.00
868-F526B	6" No-Hub w/ Poly Dome Strainer	B	1	1	\$1,550.00

## 15" Adjustable Weir Roof Drain (Cont)

### Cast Iron - No-Hub Connection

Item Number	Item Description	Pkg Type	Min Qty	Case Qty	Price
<b>ALUMINUM DOME</b>					
868-F523A	3" No-Hub w/ Aluminum Dome Strainer	B	1	1	\$1,910.00
868-F524A	4" No-Hub w/ Aluminum Dome Strainer	B	1	1	\$1,910.00
868-F526A	6" No-Hub w/ Aluminum Dome Strainer	B	1	1	\$1,910.00

## 11" Roof Drain

### Cast Iron - No-Hub Connection

**Options:** Add suffix to item no. Add price to list

V = Vandal-Resistant Dome: \$150.00; W = 2-3/16" High External Water Dam: \$210.00;

P = Steel Screen Installed Over Dome Strainer: \$140.00; STP2 = 2" High Internal Water Dam: \$210.00;

U = Underdeck Clamp Kit: \$145.00; S = Sump Receiver: \$125.00;

E = Extension Collar Kit: \$140.00;



868-I3

Item Number	Item Description	Pkg Type	Min Qty	Case Qty	Price
<b>ROOF DRAINS WITH POLY DOME STRAINER</b>					
868-I3	3" No-Hub	BI	1	2	\$920.00
868-I4	4" No-Hub	BI	1	2	\$920.00
868-I6	6" No-Hub	BI	1	2	\$995.00
<b>ROOF DRAINS WITH ALUMINUM DOME STRAINER</b>					
868-I3M	3" No-Hub	BI	1	1	\$1,270.00
868-I4M	4" No-Hub	BI	1	2	\$1,270.00
868-I6M	6" No-Hub	BI	1	1	\$1,345.00
<b>ACCESSORIES</b>					
868-CCQ	Under Deck Clamp Kit: 11" Epoxy-Coated Clamping Plate, Thread Rod, Nuts & Washers	BI	1	5	\$305.00
868-ECQ	Extension Collar Kit: Extension Collar Plate, Thread Rod, Nuts & Washers	BI	1	5	\$290.00
868-MCCQ	Epoxy-Coated Aluminum Replacement Gravel Guard	BI	1	10	\$370.00
868-MDCQ	Dome Strainer - 9-1/4" Diameter, Cast Aluminum	BI	1	5	\$350.00
868-SCQ	Sump Receiver: 11-1/2" Sump Receiver Plate	BI	1	10	\$230.00
868-WDCQ	Epoxy-Coated Aluminum External Water Dam, 2-3/16"	BI	1	1	\$450.00



868-123

### 10" Roof Drain

#### Cast Iron - No-Hub Connection

**Options:** Add suffix to item no. Add price to list  
**P** = Top Mount Sump Receiver: \$380.00; **S** = Sump Receiver: \$245.00;  
**W** = 2" High Internal Water Dam: \$365.00;

Item Number	Item Description	Pkg Type	Min Qty	Case Qty	Price
<b>CAST IRON DOME</b>					
868-123	3" No Hub w/ Cast Iron Dome Strainer	B	1	1	\$990.00
868-124	4" No Hub w/ Cast Iron Dome Strainer	B	1	1	\$990.00



868-F123

### 10" Weir Roof Drain

#### Cast Iron No-Hub Connection

**Options:** Add suffix to item no. Add price to list  
**P** = Top Mount Sump Receiver: \$380.00; **S** = Sump Receiver: \$245.00;

Item Number	Item Description	Pkg Type	Min Qty	Case Qty	Price
<b>ADJUSTABLE WEIR</b>					
868-F123	3" No Hub w/ Cast Iron Dome Strainer	B	1	1	\$1,200.00
868-F124	4" No Hub w/ Cast Iron Dome Strainer	B	1	1	\$1,200.00
<b>FIXED WEIR</b>					
868-M123	3" No Hub w/ Cast Iron Dome Strainer	B	1	1	\$1,200.00
868-M124	4" No Hub w/ Cast Iron Dome Strainer	B	1	1	\$1,200.00



868-824

### 8" Roof Drain

#### Cast Iron - No-Hub Connection

**Options:** Add suffix to item no. Add price to list  
**9** = 90-deg. Side Outlet Connection: \$310.00; **T** = Top Mount Sump Receiver: \$380.00;  
**S** = Sump Receiver: \$245.00; **C** = Underdeck Clamp Kit: \$150.00;  
**W** = 2" High Internal Water Dam: \$185.00; **P** = SS Mesh Dome Cover: \$300.00;

Item Number	Item Description	Pkg Type	Min Qty	Case Qty	Price
<b>ALUMINUM DOME</b>					
868-823	3" No-Hub w/ Aluminum Dome Strainer	B	1	1	\$750.00
868-824	4" No-Hub w/ Aluminum Dome Strainer	B	1	1	\$750.00

## 20" Large-Capacity Roof Drain

### Cast Iron - No-Hub Connection

**Options:** Add suffix to item no. Add price to list

**H** = Undermount Hardware Kit: \$404.00; **U** = Underdeck Clamp Kit: \$444.00;

**S** = Sump Receiver: \$726.00; **W** = 2" High External Water Dam: \$478.00;



868-2010

Item Number	Item Description	Pkg Type	Min Qty	Case Qty	Price
<b>ROOF DRAINS</b>					
<b>868-2010</b>	10" No-Hub - Cast Iron Dome	BI	1	1	\$1,995.00
<b>868-2012</b>	12" No-Hub - Cast Iron Dome	BI	1	1	\$2,200.00
<b>ACCESSORIES</b>					
<b>868-20CD</b>	Cast Iron Dome Strainer	BI	1	1	\$540.00
<b>868-20S</b>	Sump Receiver	BI	1	1	\$800.00
<b>868-20SH</b>	Top Mount Hardware Kit: Angle Brackets, Thread Rod, Nuts, Washers	BI	1	1	\$450.00
<b>868-20U</b>	Underdeck Clamp Kit: 4 Pieces Thread Rod, Nuts, Washers, Two Clamping Bars	BI	1	1	\$460.00
<b>868-20WD</b>	External Water Dam - 2" High	BI	1	1	\$525.00

Supply

Drainage

Support

Specialties

Appendix

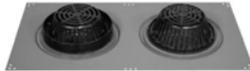

868-D1503

## 15" Roof Drain & Overflow - Alpha Series

### Cast Iron - No-Hub Connection

· 2" High external water dam (for overflow fixture) is standard

**Options:** Add suffix to item no. Add price to list

**A** = Aluminum Dome Strainer (1): \$474.00; **E** = Adjustable Extension Assembly Kit: \$1,660.00;

**H** = Undermount Hardware Kit: \$238.00; **P** = 2" High Internal Water Dam (2): N/C;

**U** = Underdeck Clamp Kit: \$458.00; **V** = Vandal-Resistant Dome: \$300.00;

1: In lieu of cast iron dome (standard) 2: In lieu of external water dam (for overflow fixture)

Item Number	Item Description	Pkg Type	Min Qty	Case Qty	Price
<b>ROOF DRAIN &amp; OVERFLOW</b>					
868-D1503	3" No-Hub Cast Iron Roof Drain & Overflow	BI	1	1	\$2,460.00
<b>868-D1504</b>	4" No-Hub Cast Iron Roof Drain & Overflow	BI	1	1	\$2,460.00
868-D1506	6" No-Hub Cast Iron Roof Drain & Overflow	BI	1	1	\$2,460.00
<b>868-D1508</b>	8" No-Hub Cast Iron Roof Drain & Overflow	BI	1	1	\$2,460.00
<b>ACCESSORIES</b>					
<b>868-15AD</b>	12-1/2" Aluminum Dome Strainer	BI	1	1	\$290.00
868-15CD	12-1/2" Cast Iron Dome Strainer	BI	1	1	\$205.00
868-15EXT	Adjustable Extension Assembly Kit	BI	1	1	\$830.00
868-15S2	Double Sump Receiver Only - 12ga Powder-Coated Steel	BI	1	1	\$787.00
868-15SH	Top Mount Hardware Kit: Angle Brackets, Thread Rod, Nuts, Washers	BI	1	10	\$119.00
868-15U	Underdeck Clamp Kit: 4 Pieces Thread Rod, Nuts, Washers, Two Clamping Bars	BI	1	5	\$229.00

## 15" Roof Drain & Overflow - Bravo Series

### Cast Iron - No-Hub Connection

· 4" High internal water dam (for overflow fixture) is standard. Can be cut/shortened per specifications

**Options:** Add suffix to item no. Add price to list

**2** = 2" High SS Perforated Extension: \$1,500.00; **4** = 4" High SS Perforated Extension: \$1,500.00;

**W** = 2" External Water Dam (1): N/C; **E** = Adjustable Extension Assembly Kit: \$1,660.00;

**G** = 2" High SS Perforated Gravel Guard: \$1,500.00; **K** = 4" High SS Perforated Gravel Guard: \$1,500.00;

**P** = Top Mount Hardware Kit: \$310.00; **C** = Underdeck Clamp: \$460.00;

1: In lieu of internal water dam (for overflow fixture)

Item Number	Item Description	Pkg Type	Min Qty	Case Qty	Price
<b>CAST IRON DOME</b>					
868-D523	3" No-Hub w/ Cast Iron Dome Strainer	B	1	1	\$2,750.00
868-D524	4" No-Hub w/ Cast Iron Dome Strainer	B	1	1	\$2,750.00
868-D526	6" No-Hub w/ Cast Iron Dome Strainer	B	1	1	\$3,400.00
<b>868-D528</b>	8" No-Hub w/ Cast Iron Dome Strainer	B	1	1	\$3,895.00



## 15" Roof Drain & Overflow - Bravo Series (Cont)

### Cast Iron - No-Hub Connection



868-D524B

Item Number	Item Description	Pkg Type	Min Qty	Case Qty	Price
<b>POLY DOME</b>					
868-D523B	3" No-Hub w/ Poly Dome Strainer	B	1	1	\$2,357.00
868-D524B	4" No-Hub w/ Poly Dome Strainer	B	1	1	\$2,357.00
868-D526B	6" No-Hub w/ Poly Dome Strainer	B	1	1	\$2,930.00
868-D528B	8" No-Hub w/ Poly Dome Strainer	B	1	1	\$3,500.00
<b>ALUMINUM DOME</b>					
868-D523A	3" No-Hub w/ Aluminum Dome Strainer	B	1	1	\$3,224.00
868-D524A	4" No-Hub w/ Aluminum Dome Strainer	B	1	1	\$3,224.00
868-D526A	6" No-Hub w/ Aluminum Dome Strainer	B	1	1	\$3,874.00
868-D528A	8" No-Hub w/ Aluminum Dome Strainer	B	1	1	\$4,369.00
<b>ACCESSORIES</b>					
868-5AD	Aluminum Dome Strainer	B	1	1	\$250.00
868-5CD	Cast Iron Dome Strainer	BI	1	1	\$250.00
868-5EXT	Adjustable/Threaded Extension Assembly Kit	BI	1	1	\$830.00
868-5PD	ABS Dome Strainer	BI	1	1	\$150.00
868-5S2	Double Sump Receiver Only - Coated Steel	BI	1	1	\$787.00
868-5SH	Top Mount Hardware Kit: Angle Brackets, Screws	BI	1	50	\$155.00
868-5U	Underdeck Clamp Kit: Clamping Ring, Thread Rod, Nuts, Washers	BI	1	1	\$230.00

## 10" Roof Drain & Overflow

### Cast Iron - No-Hub Connection

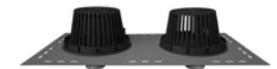

868-D123

· 4" High internal water dam (for overflow fixture). Can be cut/shortened per specifications

**Options:** Add suffix to item no. Add price to list

P = Top Mount Hardware Kit: \$270.00; C = Underdeck Clamp: \$290.00;

Item Number	Item Description	Pkg Type	Min Qty	Case Qty	Price
868-D123	3" No Hub w/ Cast Iron Dome Strainer	B	1	1	\$2,100.00
868-D124	4" No Hub w/ Cast Iron Dome Strainer	B	1	1	\$2,100.00

Supply

Drainage

Support

Specialties

Appendix



868-D824

## 8" Roof Drain & Overflow

### Cast Iron - No-Hub Connection

· 4" High internal water dam (for overflow fixture). Can be cut/shortened per specifications

**Options:** Add suffix to item no. Add price to list

**9** = 90-deg. Side Outlet Connection: \$620.00; **C** = Underdeck Clamp: \$290.00;

**P** = SS Mesh Dome Cover: \$600.00;

Item Number	Item Description	Pkg Type	Min Qty	Case Qty	Price
868-D823	3" No-Hub w/ Aluminum Dome Strainer	B	1	1	\$1,500.00
868-D824	4" No-Hub w/ Aluminum Dome Strainer	B	1	1	\$1,500.00

Promenade Drain

Cast Iron - No-Hub Connection

Options: Add suffix to item no. Add price to list

2 = 2" High SS Perforated Extension: \$750.00; 4 = 4" High SS Perforated Extension: \$750.00;

9 = 90-deg. Side Outlet Connection (1): \$500.00; B = Sediment Bucket (2): \$250.00;

C = Underdeck Clamp: \$250.00; E = Adjustable Extension Assembly Kit: \$830.00;

P = Top Mount Sump Receiver: \$450.00; S = Sump Receiver: \$260.00;

X = Extra Heavy-Duty Grate: \$250.00;

1: Not available for 6" drains 2: Not available for drains with Adjustable Extension



868-R623I



868-R623IN



868-Q624IN

Item Number	Item Description	Pkg Type	Min Qty	Case Qty	Price
<b>ROUND DUCTILE STRAINER</b>					
868-R623I	3" No-Hub - 16" Ductile Iron Ring & Strainer	B	1	1	\$2,450.00
868-R624I	4" No-Hub - 16" Ductile Iron Ring & Strainer	B	1	1	\$2,450.00
868-R626I	6" No-Hub - 16" Ductile Iron Ring & Strainer	B	1	1	\$2,450.00
868-R628I	8" No-Hub - 16" Ductile Iron Ring & Strainer	B	1	1	\$2,450.00
<b>ROUND DUCTILE STRAINER - NICKEL-BRONZE VENEER</b>					
868-R623IN	3" No-Hub - 16-3/8" Ductile Iron w/ NB Veneer Ring & Strainer	B	1	1	\$4,890.00
868-R624IN	4" No-Hub - 16-3/8" Ductile Iron w/ NB Veneer Ring & Strainer	B	1	1	\$4,890.00
868-R626IN	6" No-Hub - 16-3/8" Ductile Iron w/ NB Veneer Ring & Strainer	B	1	1	\$4,890.00
868-R628IN	8" No-Hub - 16-3/8" Ductile Iron w/ NB Veneer Ring & Strainer	B	1	1	\$4,890.00
<b>SQUARE DUCTILE STRAINER</b>					
868-Q623I	3" No-Hub - 16" Ductile Iron Ring & Strainer	B	1	1	\$2,780.00
868-Q624I	4" No-Hub - 16" Ductile Iron Ring & Strainer	B	1	1	\$2,780.00
868-Q626I	6" No-Hub - 16" Ductile Iron Ring & Strainer	B	1	1	\$2,780.00
868-Q628I	8" No-Hub - 16" Ductile Iron Ring & Strainer	B	1	1	\$2,780.00
<b>SQUARE DUCTILE STRAINER - NICKEL-BRONZE VENEER</b>					
868-Q623IN	3" No-Hub - 16-3/8" Ductile Iron w/ NB Veneer Ring & Strainer	B	1	1	\$5,290.00
868-Q624IN	4" No-Hub - 16-3/8" Ductile Iron w/ NB Veneer Ring & Strainer	B	1	1	\$5,290.00
868-Q626IN	6" No-Hub - 16-3/8" Ductile Iron w/ NB Veneer Ring & Strainer	B	1	1	\$5,290.00
868-Q628IN	8" No-Hub - 16-3/8" Ductile Iron w/ NB Veneer Ring & Strainer	B	1	1	\$5,290.00

Supply

Drainage

Support

Specialties

Appendix

Supply

Drainage

Support

Specialties

Appendix



868-S4A



868-S4F

### Cast Iron - FIP Connection

Item Number	Item Description	Pkg Type	Min Qty	Case Qty	Price
<b>ANGLE ALUMINUM STRAINER</b>					
868-S3A	3" FIP Scupper w/ Angled Aluminum Grate	BI	1	1	\$800.00
868-S4A	4" FIP Scupper w/ Angled Aluminum Grate	BI	1	1	\$800.00
868-S6A	6" FIP Scupper w/ Angled Aluminum Grate	BI	1	1	\$1,300.00
<b>FLUSH ALUMINUM STRAINER</b>					
868-S3F	3" FIP Scupper w/ Flush Aluminum Grate	BI	1	1	\$800.00
868-S4F	4" FIP Scupper w/ Flush Aluminum Grate	BI	1	1	\$800.00
868-S6F	6" FIP Scupper w/ Flush Aluminum Grate	BI	1	1	\$1,300.00

### Nickel-Bronze Downspout Nozzles

Item Number	Item Description	Pkg Type	Min Qty	Case Qty	Price
<b>NO-HUB CONNECTION</b>					
868-N3H	Downspout Nozzle 3" w/ Ring No-Hub Connection	BI	1	1	\$1,338.00
868-N4H	Downspout Nozzle 4" w/ Ring No-Hub Connection	BI	1	1	\$1,338.00
868-N6H	Downspout Nozzle 6" w/ Ring No-Hub Connection	BI	1	1	\$2,402.00
868-N8H	Downspout Nozzle 8" w/ Ring No-Hub Connection	BI	1	1	\$3,285.00
<b>FIP THREAD CONNECTION</b>					
868-N3F	Downspout Nozzle 3" w/ Ring FIP Thread Connection	BI	1	1	\$1,338.00
868-N4F	Downspout Nozzle 4" w/ Ring FIP Thread Connection	BI	1	1	\$1,338.00
<b>868-N6F</b>	Downspout Nozzle 6" w/ Ring FIP Thread Connection	BI	1	1	\$2,402.00
<b>868-N8F</b>	Downspout Nozzle 8" w/ Ring FIP Thread Connection	BI	1	1	\$3,285.00
<b>ACCESSORIES</b>					
868-NS3	3" Bird Screen w/ Screws	BI	1	1	\$85.00
868-NS4	4" Bird Screen w/ Screws	BI	1	50	\$100.00
868-NS6	6" Bird Screen w/ Screws	BI	1	50	\$115.00
<b>868-NS8</b>	8" Bird Screen w/ Screws	BI	1	1	\$130.00



868-N3H



868-N6F

### Stainless Steel Downspout Nozzle Cover

Item Number	Item Description	Pkg Type	Min Qty	Case Qty	Price
868-N3S	3", Hinged Cover	BI	1	1	\$3,604.00
868-N4S	4", Hinged Cover	BI	1	1	\$3,604.00
868-N6S	6", Hinged Cover	BI	1	1	\$3,801.00
868-N8S	8", Hinged Cover	BI	1	1	\$3,989.00



### Vent Cap

#### Cast Iron - Set Screw Connection

Item Number	Item Description	Pkg Type	Min Qty	Case Qty	Price
868-V234	Cast Iron Vent Cap For 2", 3", Or 4" Pipe	BI	1	1	\$500.00



868-V234

Supply

Drainage

Support

Specialties

Appendix



# Specification Cleanouts

**FinishLine™ Adjustable Cleanouts**

**Access Cover Cleanouts**

**Halo™ Cleanouts**

**Cleanout Fittings**

**Wall Cleanouts**

**Plugs**



FinishLine™ Cleanouts are adjustable both before and AFTER the concrete pour. The FinishLine virtually eliminates cleanouts set too low or not level. Installations are faster, easier, and more professional looking.



**834-4DNR**  
Page 297



**834-6DNR**  
Page 298



**834-3SSR**  
Page 300



**854-22IQ**  
Page



**854-22IS**  
Page



**851-24I**  
Page 306



**850-9I**  
Page 307



**822-C3DSR**  
Page 308



**853-T24I**  
Page 309



**873-36**  
Page 310



**971-99**  
Page 310



**876-RS30**  
Page 311

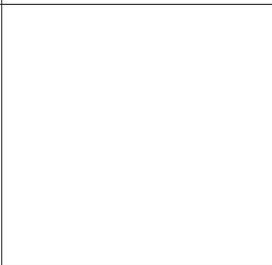
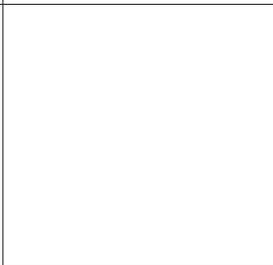
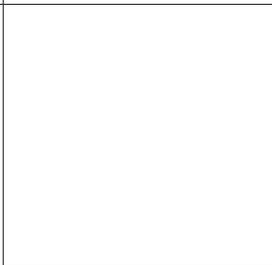
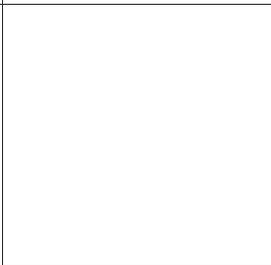
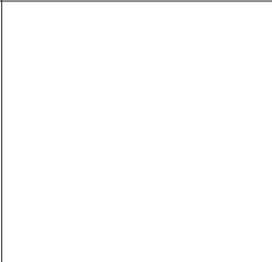
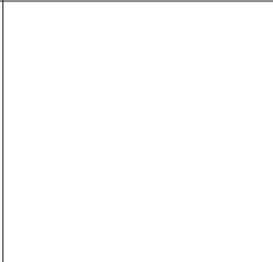
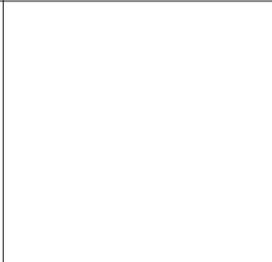
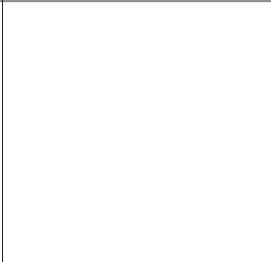
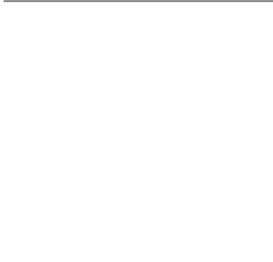



Cast Iron - No-Hub Connection

6-1/2" Tops

Options: Add suffix to item no. Add price to list

V = Vandal-Resistant Cover: \$23.00; S = Stamping: Specify Letters (1): \$75.00;

C = Carpet Marker: \$100.00; B = Brass Cleanout Plug (2): \$85.00;

Z = Complies with Buy American Act (3): \$125.00; H = Special-Duty Cover (15,000 lbs. safe load) (4): \$135.00;

1: Not available for iron covers 2: In lieu of polypro (standard) 3: For round nickel-bronze covers only 4: Not available for stainless steel covers

Item Number	Item Description	Pkg Type	Min Qty	Case Qty	Price
<b>ROUGH-IN FIXTURE</b>					
834-3DF	3" No-Hub	BI	1	5	\$300.00
834-4DF	4" No-Hub	BI	1	5	\$300.00
<b>FINISH FIXTURE</b>					
834-4DHIR	6-1/2" Rnd Ductile Iron Ring & Cover	BI	1	10	\$325.00
834-4DHNQ	6-5/8" Sqr Nikl-Brnz Ring & Cover	BI	1	10	\$600.00
834-4DHNR	6-1/2" Rnd Nikl-Brnz Ring & Cover	BI	1	10	\$500.00
834-4DHSQ	6-5/8" Sqr Stnls Steel Ring & Cover	BI	1	1	\$600.00
834-4DHSR	6-1/2" Rnd Stnls Steel Ring & Cover	BI	1	1	\$500.00
<b>COMPLETE ASSEMBLY</b>					
834-3DIR	3" No-Hub - 6-1/2" Rnd Ductile Iron Ring & Cover	BI	1	1	\$625.00
834-3DNQ	3" No-Hub - 6-5/8" Sqr Nikl-Brnz Ring & Cover	BI	1	1	\$900.00
834-3DNR	3" No-Hub - 6-1/2" Rnd Nikl-Brnz Ring & Cover	BI	1	1	\$800.00
834-3DSQ	3" No-Hub - 6-5/8" Sqr Stnls Steel Ring & Cover	BI	1	1	\$900.00
834-3DSR	3" No-Hub - 6-1/2" Rnd Stnls Steel Ring & Cover	BI	1	1	\$800.00
834-4DIR	4" No-Hub - 6-1/2" Rnd Ductile Iron Ring & Cover	BI	1	1	\$625.00
834-4DNQ	4" No-Hub - 6-5/8" Sqr Nikl-Brnz Ring & Cover	BI	1	1	\$900.00
834-4DNR	4" No-Hub - 6-1/2" Rnd Nikl-Brnz Ring & Cover	BI	1	1	\$800.00
834-4DSQ	4" No-Hub - 6-5/8" Sqr Stnls Steel Ring & Cover	BI	1	1	\$900.00
834-4DSR	4" No-Hub - 6-1/2" Rnd Stnls Steel Ring & Cover	BI	1	1	\$800.00
<b>ACCESSORIES</b>					
832-EX4CQ	Ductile Iron Extension Adapter - 2" Min - 4" Max	BI	1	1	\$120.00
832-PCQ	Coring Plug Wrench	BI	1	1	\$87.00
832-S4CQ	Two Adjustment Shims, Two 3/4" Screws	BI	1	10	\$22.00
832-WCQ	Flexible Red Locating Bristles w/ Screw	BI	1	10	\$26.00



834-3DF



834-4DHIR



834-3DIR



832-WCQ

Supply

Drainage

Support

Specialties

Appendix

Supply

Drainage

Support

Specialties

Appendix



834-49DF



834-6DHR



834-6DIR



832-P



834-63DF

## Cast Iron - No-Hub Connection

### 9" Tops

**Options:** Add suffix to item no. Add price to list

**V** = Vandal-Resistant Cover: \$23.00; **S** = Stamping: specify letters (1): \$75.00;

**C** = Carpet Marker: \$30.00; **B** = Brass Cleanout Plug (2): \$75.00;

**F** = Clamping Collar: \$149.00;

1: Not available for iron covers 2: In lieu of polypro (standard)

Item Number	Item Description	Pkg Type	Min Qty	Case Qty	Price
<b>ROUGH-IN FIXTURE</b>					
834-49DF	4" No-Hub	BI	1	1	\$600.00
834-6DF	6" No-Hub	BI	1	1	\$600.00
<b>FINISH FIXTURE</b>					
834-6DHIR	9" Rnd Iron Ring & Cover	BI	1	1	\$700.00
834-6DHR	9" Rnd Nikl-Brnz Ring & Cover	BI	1	1	\$1,100.00
834-6DHSR	9" Rnd Stnls Steel Ring & Cover	BI	1	1	\$1,100.00
<b>COMPLETE ASSEMBLY</b>					
834-49DIR	4" No-Hub - 9" Rnd Ductile Iron Ring & Cover	BI	1	1	\$1,300.00
834-49DNR	4" No-Hub - 9" Rnd Nikl-Brnz Ring & Cover	BI	1	1	\$1,700.00
834-49DSR	4" No-Hub - 9" Rnd Stnls Steel Ring & Cover	BI	1	1	\$1,700.00
834-6DIR	6" No-Hub - 9" Rnd Ductile Iron Ring & Cover	BI	1	1	\$1,300.00
834-6DNR	6" No-Hub - 9" Rnd Nikl-Brnz Ring & Cover	BI	1	1	\$1,700.00
834-6DSR	6" No-Hub - 9" Rnd Stnls Steel Ring & Cover	BI	1	1	\$1,700.00
<b>ACCESSORIES</b>					
832-PCQ	Coring Plug Wrench	BI	1	1	\$87.00
832-WCQ	Flexible Red Locating Bristles w/ Screw	BI	1	10	\$26.00

## Cast Iron - Push-Joint Connection

### 6-1/2" Tops

**Options:** Add suffix to item no. Add price to list

**V** = Vandal-Resistant Cover: \$23.00; **S** = Stamping: Specify Letters (1): \$75.00;

**C** = Carpet Marker: \$100.00; **B** = Brass Cleanout Plug (2): \$85.00;

**Z** = Complies with Buy American Act (3): \$125.00; **P** = Push-joint Gasket to fit Sch. 40 ABS/PVC Pipe: \$25.00;

**H** = Special-Duty Cover (15,000 lbs. safe load) (4): \$135.00;

1: Not available for iron covers. 2: In lieu of polypro (standard) 3: For round nickel-bronze covers only 4: Not available for stainless steel covers

Item Number	Item Description	Pkg Type	Min Qty	Case Qty	Price
<b>ROUGH-IN FIXTURE</b>					
834-63DF	3" PJ Conn.	BI	1	1	\$300.00
834-64DF	4" PJ Conn.	BI	1	1	\$300.00

**Cast Iron - Push-Joint Connection (Cont)**

**6-1/2" Tops**

Item Number	Item Description	Pkg Type	Min Qty	Case Qty	Price
<b>FINISH FIXTURE</b>					
834-4DHIR	6-1/2" Rnd Ductile Iron Ring & Cover	BI	1	10	\$325.00
834-4DHNQ	6-5/8" Sqr Nikl-Brnz Ring & Cover	BI	1	10	\$600.00
834-4DHNR	6-1/2" Rnd Nikl-Brnz Ring & Cover	BI	1	10	\$500.00
834-4DHSQ	6-5/8" Sqr Stnls Steel Ring & Cover	BI	1	1	\$600.00
834-4DHSR	6-1/2" Rnd Stnls Steel Ring & Cover	BI	1	1	\$500.00
<b>COMPLETE ASSEMBLY</b>					
834-63DIR	3" PJ Conn. - 6-1/2" Rnd Ductile Iron Ring & Cover	BI	1	1	\$625.00
834-63DNQ	3" PJ Conn. - 6-5/8" Sqr Nikl-Brnz Ring & Cover	BI	1	1	\$900.00
834-63DNR	3" PJ Conn. - 6-1/2" Rnd Nikl-Brnz Ring & Cover	BI	1	1	\$800.00
834-63DSQ	3" PJ Conn. - 6-5/8" Sqr Stnls Steel Ring & Cover	BI	1	1	\$900.00
834-63DSR	3" PJ Conn. - 6-1/2" Rnd Stnls Steel Ring & Cover	BI	1	1	\$800.00
834-64DIR	4" PJ Conn. - 6-1/2" Rnd Ductile Iron Ring & Cover	BI	1	1	\$625.00
834-64DNQ	4" PJ Conn. - 6-5/8" Sqr Nikl-Brnz Ring & Cover	BI	1	1	\$900.00
834-64DNR	4" PJ Conn. - 6-1/2" Rnd Nikl-Brnz Ring & Cover	BI	1	1	\$800.00
834-64DSQ	4" PJ Conn. - 6-5/8" Sqr Stnls Steel Ring & Cover	BI	1	1	\$900.00
834-64DSR	4" PJ Conn. - 6-1/2" Rnd Stnls Steel Ring & Cover	BI	1	1	\$800.00
<b>ACCESSORIES</b>					
832-EX4CQ	Ductile Iron Extension Adapter - 2" Min - 4" Max	BI	1	1	\$120.00
832-PCQ	Coring Plug Wrench	BI	1	1	\$87.00
832-S4CQ	Two Adjustment Shims, Two 3/4" Screws	BI	1	10	\$22.00
832-WCQ	Flexible Red Locating Bristles w/ Screw	BI	1	10	\$26.00



834-4DHIR



834-63DNQ

Supply

Drainage

Support

Specialties

Appendix

Supply

Drainage

Support

Specialties

Appendix



834-3SF



834-4SHSR



834-3SSR

## Stainless Steel - No-Hub Connection

### 6-1/2" Tops

**Options:** Add suffix to item no. Add price to list  
 V = Vandal-Resistant Cover: \$23.00;

Item Number	Item Description	Pkg Type	Min Qty	Case Qty	Price
<b>ROUGH-IN FIXTURE</b>					
834-3SF	3" Hub	BI	1	1	\$1,500.00
834-4SF	4" Hub	BI	1	1	\$1,500.00
<b>FINISH FIXTURE</b>					
834-4SHSQ	6-5/8" Sqr Stnls Steel Ring & Cover	BI	1	1	\$1,500.00
834-4SHSR	6-1/2" Rnd Stnls Steel Ring & Cover	BI	1	1	\$1,200.00
<b>COMPLETE ASSEMBLY</b>					
834-3SSQ	3" No-Hub - 6-5/8" Sqr Stnls Steel Ring & Cover	BI	1	1	\$3,000.00
834-3SSR	3" No-Hub - 6-1/2" Rnd Stnls Steel Ring & Cover	BI	1	1	\$2,700.00
834-4SSQ	4" No-Hub - 6-5/8" Sqr Stnls Steel Ring & Cover	BI	1	1	\$3,000.00
834-4SSR	4" No-Hub - 6-1/2" Rnd Stnls Steel Ring & Cover	BI	1	1	\$2,700.00
<b>ACCESSORIES</b>					
832-PCQ	Coring Plug Wrench	BI	1	1	\$87.00
832-S4CQ	Two Adjustment Shims, Two 3/4" Screws	BI	1	10	\$22.00
832-WCQ	Flexible Red Locating Bristles w/ Screw	BI	1	10	\$26.00

## Cast Iron - No-Hub Connection

### Nickel-Bronze Cover

**Options:** Add suffix to item no. Add price to list

**A** = Acid-Resistant Epoxy Coated Cast Iron: \$335.00; **B** = Brass Cleanout Plug (1): \$153.00;  
**F** = Anchor Flange with Clamping Collar: \$125.00; **C** = Nickel-Bronze Carpet Clamp: \$295.00;  
**M** = Carpet Marker: \$75.00;

1: In lieu of ABS (standard)

Item Number	Item Description	Pkg Type	Min Qty	Case Qty	Price
<b>ROUND COVER</b>					
854-23NR	3" No-Hub - 5-1/4" Nickel-Bronze Ring & Cover	B	1	1	\$800.00
854-24NR	4" No-Hub - 5-1/4" Nickel-Bronze Ring & Cover	B	1	1	\$800.00
<b>SQUARE COVER</b>					
854-23NQ	3" No-Hub - 5-1/4" Nickel-Bronze Ring & Cover	B	1	1	\$920.00
854-24NQ	4" No-Hub - 5-1/4" Nickel-Bronze Ring & Cover	B	1	1	\$920.00



854-24NR



854-24NQ

## Cast Iron - No-Hub Connection

### Stainless Steel Cover

**Options:** Add suffix to item no. Add price to list

**A** = Acid-Resistant Epoxy Coated Cast Iron: \$335.00; **B** = Brass Cleanout Plug (1): \$153.00;  
**F** = Anchor Flange with Clamping Collar: \$125.00; **M** = Carpet Marker: \$75.00;

1: In lieu of ABS (standard)

Item Number	Item Description	Pkg Type	Min Qty	Case Qty	Price
<b>ROUND COVER</b>					
854-23SR	3" No-Hub - 5-1/4" Stainless Steel Ring & Cover	B	1	1	\$1,000.00
854-24SR	4" No-Hub - 5-1/4" Stainless Steel Ring & Cover	B	1	1	\$1,000.00



854-24SR

Supply

Drainage

Support

Specialties

Appendix



854-24I



854-24IQ

### Cast Iron - No-Hub Connection

#### Ductile Iron Cover

**Options:** Add suffix to item no. Add price to list

**A** = Acid-Resistant Epoxy Coated Cast Iron: \$335.00; **B** = Brass Cleanout Plug (1): \$153.00;  
**F** = Anchor Flange with Clamping Collar: \$125.00; **C** = Nickel-Bronze Carpet Clamp: \$295.00;  
**M** = Carpet Marker: \$75.00;

1: In lieu of ABS (standard)

Item Number	Item Description	Pkg Type	Min Qty	Case Qty	Price
<b>ROUND COVER</b>					
854-23I	3" No-Hub - 5-1/4" Ductile Iron Ring & Cover	B	1	1	\$700.00
854-24I	4" No-Hub - 5-1/4" Ductile Iron Ring & Cover	B	1	1	\$700.00
854-26I	6" No-Hub - 8-1/4" Ductile Iron Ring & Cover	B	1	1	\$1,500.00
854-28I	8" No-Hub - 9-1/4" Ductile Iron Ring & Cover	B	1	1	\$1,775.00
<b>SQUARE COVER</b>					
854-23IQ	3" No-Hub - 5-1/4" Ductile Iron Ring & Cover	B	1	1	\$800.00
854-24IQ	4" No-Hub - 5-1/4" Ductile Iron Ring & Cover	B	1	1	\$800.00

### Cast Iron - No-Hub Connection

#### Ductile Iron Cover with Nickel-Bronze Veneer

**Options:** Add suffix to item no. Add price to list

**A** = Acid-Resistant Epoxy Coated Cast Iron: \$335.00; **B** = Brass Cleanout Plug (1): \$153.00;  
**F** = Anchor Flange with Clamping Collar: \$125.00; **C** = Nickel-Bronze Carpet Clamp: \$295.00;  
**M** = Carpet Marker: \$75.00;

1: In lieu of ABS (standard)



854-24IN



854-22INQ

Item Number	Item Description	Pkg Type	Min Qty	Case Qty	Price
<b>ROUND COVER</b>					
854-23IN	3" No-Hub - 5-5/8" Ductile Iron w/ NB Veneer Ring & Cover	B	1	1	\$900.00
854-24IN	4" No-Hub - 5-5/8" Ductile Iron w/ NB Veneer Ring & Cover	B	1	1	\$900.00
854-26IN	6" No-Hub - 8-3/4" Ductile Iron w/ NB Veneer Ring & Cover	B	1	1	\$1,700.00
854-28IN	8" No-Hub - 9-3/4" Ductile Iron w/ NB Veneer Ring & Cover	B	1	1	\$1,975.00
<b>SQUARE COVER</b>					
854-23INQ	3" No-Hub - 5-5/8" Ductile Iron w/ NB Veneer Ring & Cover	B	1	1	\$920.00
854-24INQ	4" No-Hub - 5-5/8" Ductile Iron w/ NB Veneer Ring & Cover	B	1	1	\$920.00

## Cast Iron - No-Hub Connection

### Ductile Iron Cover with Stainless Steel Veneer

**Options:** Add suffix to item no. Add price to list

**A** = Acid-Resistant Epoxy Coated Cast Iron: \$335.00; **B** = Brass Cleanout Plug (1): \$153.00;

**F** = Anchor Flange with Clamping Collar: \$125.00; **M** = Carpet Marker: \$75.00;

1: In lieu of ABS (standard)



854-22IS

Item Number	Item Description	Pkg Type	Min Qty	Case Qty	Price
<b>ROUND COVER</b>					
854-23IS	3" No-Hub - 5-5/8" Ductile Iron w/ SS Veneer Ring & Cover	B	1	1	\$1,000.00
854-24IS	4" No-Hub - 5-5/8" Ductile Iron w/ SS Veneer Ring & Cover	B	1	1	\$1,000.00
854-26IS	6" No-Hub - 8-3/4" Ductile Iron w/ SS Veneer Ring & Cover	B	1	1	\$1,900.00
854-28IS	8" No-Hub - 9-3/4" Ductile Iron w/ SS Veneer Ring & Cover	B	1	1	\$2,200.00

## Cast Iron - Push-Joint Connection

### Nickel-Bronze Cover

**Options:** Add suffix to item no. Add price to list

**A** = Acid-Resistant Epoxy Coated Cast Iron: \$335.00; **B** = Brass Cleanout Plug (1): \$153.00;

**F** = Anchor Flange with Clamping Collar: \$125.00; **C** = Nickel-Bronze Carpet Clamp: \$295.00;

**M** = Carpet Marker: \$75.00;

1: In lieu of ABS (standard)



854-64NR



854-64NQ

Item Number	Item Description	Pkg Type	Min Qty	Case Qty	Price
<b>ROUND COVER</b>					
854-63NR	3" PJ Conn. - 5-1/4" Nickel-Bronze Ring & Cover	B	1	1	\$800.00
854-64NR	4" PJ Conn. - 5-1/4" Nickel-Bronze Ring & Cover	B	1	1	\$800.00
<b>SQUARE COVER</b>					
854-63NQ	3" PJ Conn. - 5-1/4" Nickel-Bronze Ring & Cover	B	1	1	\$920.00
854-64NQ	4" PJ Conn. - 5-1/4" Nickel-Bronze Ring & Cover	B	1	1	\$920.00

Supply

Drainage

Support

Specialties

Appendix



854-64SR

### Cast Iron - Push-Joint Connection Stainless Steel Cover

**Options:** Add suffix to item no. Add price to list

**A** = Acid-Resistant Epoxy Coated Cast Iron: \$335.00; **B** = Brass Cleanout Plug (1): \$153.00;

**F** = Anchor Flange with Clamping Collar: \$125.00; **M** = Carpet Marker: \$75.00;

1: In lieu of ABS (standard)

Item Number	Item Description	Pkg Type	Min Qty	Case Qty	Price
<b>ROUND COVER</b>					
854-63SR	3" PJ Conn. - 5-1/4" Stainless Steel Ring & Cover	B	1	1	\$1,000.00
854-64SR	4" PJ Conn. - 5-1/4" Stainless Steel Ring & Cover	B	1	1	\$1,000.00

### Cast Iron - Push-Joint Connection Ductile Iron Cover

**Options:** Add suffix to item no. Add price to list

**A** = Acid-Resistant Epoxy Coated Cast Iron: \$335.00; **B** = Brass Cleanout Plug (1): \$153.00;

**F** = Anchor Flange with Clamping Collar: \$125.00; **C** = Nickel-Bronze Carpet Clamp: \$295.00;

**M** = Carpet Marker: \$75.00;

1: In lieu of ABS (standard)



854-62I



854-62IQ

Item Number	Item Description	Pkg Type	Min Qty	Case Qty	Price
<b>ROUND COVER</b>					
854-63I	3" PJ Conn. - 5-1/4" Ductile Iron Ring & Cover	B	1	1	\$700.00
854-64I	4" PJ Conn. - 5-1/4" Ductile Iron Ring & Cover	B	1	1	\$700.00
854-66I	6" PJ Conn. - 8-1/4" Ductile Iron Ring & Cover	B	1	1	\$1,500.00
854-68I	8" PJ Conn. - 9-1/4" Ductile Iron Ring & Cover	B	1	1	\$1,775.00
<b>SQUARE COVER</b>					
854-63IQ	3" PJ Conn. - 5-1/4" Ductile Iron Ring & Cover	B	1	1	\$800.00
854-64IQ	4" PJ Conn. - 5-1/4" Ductile Iron Ring & Cover	B	1	1	\$800.00



## Cast Iron - Push-Joint Connection

### Ductile Iron Cover with Nickel-Bronze Veneer

**Options:** Add suffix to item no. Add price to list

**A** = Acid-Resistant Epoxy Coated Cast Iron: \$335.00; **B** = Brass Cleanout Plug (1): \$153.00;  
**F** = Anchor Flange with Clamping Collar: \$125.00; **C** = Nickel-Bronze Carpet Clamp: \$295.00;  
**M** = Carpet Marker: \$75.00;

1: In lieu of ABS (standard)

Item Number	Item Description	Pkg Type	Min Qty	Case Qty	Price
<b>ROUND COVER</b>					
854-63IN	3" PJ Conn. - 5-5/8" Ductile Iron w/ NB Veneer Ring & Cover	B	1	1	\$900.00
854-64IN	4" PJ Conn. - 5-5/8" Ductile Iron w/ NB Veneer Ring & Cover	B	1	1	\$900.00
854-66IN	6" PJ Conn. - 8-3/4" Ductile Iron w/ NB Veneer Ring & Cover	B	1	1	\$1,700.00
854-68IN	8" PJ Conn. - 9-3/4" Ductile Iron w/ NB Veneer Ring & Cover	B	1	1	\$1,975.00
<b>SQUARE COVER</b>					
854-63INQ	3" PJ Conn. - 5-5/8" Ductile Iron w/ NB Veneer Ring & Cover	B	1	1	\$920.00
854-64INQ	4" PJ Conn. - 5-5/8" Ductile Iron w/ NB Veneer Ring & Cover	B	1	1	\$800.00



854-62IN



854-62INQ

## Cast Iron - Push-Joint Connection

### Ductile Iron Cover with Stainless Steel Veneer

**Options:** Add suffix to item no. Add price to list

**A** = Acid-Resistant Epoxy Coated Cast Iron: \$335.00; **B** = Brass Cleanout Plug (1): \$153.00;  
**F** = Anchor Flange with Clamping Collar: \$125.00; **M** = Carpet Marker: \$75.00;

1: In lieu of ABS (standard)

Item Number	Item Description	Pkg Type	Min Qty	Case Qty	Price
<b>ROUND COVER</b>					
854-63IS	3" PJ Conn. - 5-5/8" Ductile Iron w/ SS Veneer Ring & Cover	B	1	1	\$1,000.00
854-64IS	4" PJ Conn. - 5-5/8" Ductile Iron w/ SS Veneer Ring & Cover	B	1	1	\$1,000.00
854-66IS	6" PJ Conn. - 8-3/4" Ductile Iron w/ SS Veneer Ring & Cover	B	1	1	\$1,900.00
854-68IS	8" PJ Conn. - 9-3/4" Ductile Iron w/ SS Veneer Ring & Cover	B	1	1	\$2,200.00



854-62IS

Supply

Drainage

Support

Specialties

Appendix

Supply

Drainage

Support

Specialties

Appendix



851-24N



851-24I



851-64N



851-64I

### Cast Iron - No-Hub Connection

**Options:** Add suffix to item no. Add price to list

**V** = Vandal-Resistant Cover: \$23.00; **S** = Stamping: Specify Letters (1): \$75.00;

**C** = Carpet Marker (1): \$75.00;

1: Not available for cast iron covers

Item Number	Item Description	Pkg Type	Min Qty	Case Qty	Price
<b>NICKEL-BRONZE COVER</b>					
851-24N	4" Cast Iron No-Hub - 6" Rnd Ring & Cover	BI	1	2	\$900.00
<b>TENZ-ALLOY COVER</b>					
851-24T	4" Cast Iron No-Hub - 6" Rnd Ring & Cover	BI	1	2	\$550.00
<b>CAST IRON COVER</b>					
851-24I	4" Cast Iron No-Hub - 6" Rnd Ring & Cover	BI	1	2	\$425.00

### Cast Iron - Push-Joint Connection

**Options:** Add suffix to item no. Add price to list

**V** = Vandal-Resistant Cover: \$23.00; **S** = Stamping: Specify Letters (1): \$75.00;

**C** = Carpet Marker (1): \$75.00; **P** = Push-Joint Gasket to fit Sch. 40 ABS/PVC Pipe (2): \$25.00;

1: Not available for cast iron covers 2: For 4" cleanouts only

Item Number	Item Description	Pkg Type	Min Qty	Case Qty	Price
<b>NICKEL-BRONZE COVER</b>					
851-64N	4" Cast Iron PJ Conn. - 6" Rnd Ring & Cover	BI	1	2	\$900.00
851-66N	6" Cast Iron PJ Conn. - 8-3/8" Rnd Ring & Cover	BI	1	2	\$2,300.00
<b>TENZ-ALLOY COVER</b>					
851-64T	4" Cast Iron PJ Conn. - 6" Rnd Ring & Cover	BI	1	2	\$550.00
851-66T	6" Cast Iron PJ Conn. - 8-3/8" Rnd Ring & Cover	BI	1	2	\$1,600.00
<b>CAST IRON COVER</b>					
851-64I	4" Cast Iron PJ Conn. - 6" Rnd Ring & Cover	BI	1	2	\$425.00
851-66I	6" Cast Iron PJ Conn. - 8-3/8" Rnd Ring & Cover	BI	1	2	\$1,600.00

## Heavy-Duty Cleanout Housing

### Double Flanged

Item Number	Item Description	Pkg Type	Min Qty	Case Qty	Price
<b>CAST IRON</b>					
850-9I	8-1/2" Inner Diam, w/ Lifting Device	BI	1	1	\$1,700.00
<b>NB LAMINATED CAST IRON</b>					
850-9IN	8-1/2" Inner Diam, w/ Lifting Device	BI	1	1	\$2,400.00



850-9I



850-9IN

Supply

Drainage

Support

Specialties

Appendix



822-C3DNQ



822-C3DSR

## Halo™ Adjustable Cleanouts

### Cast Iron - No-Hub Connection

· Halo cleanout fixtures include 882-ST302 mechanical sealing plug

**Options:** Add suffix to item no. Add price to list

**V** = Vandal-Resistant Cover: \$23.00; **S** = Stamping: Specify Letters: \$75.00;

**C** = Carpet Marker: \$75.00; **Z** = Complies with Buy American Act (1): \$125.00;

1: For round nickel-bronze covers only

Item Number	Item Description	Pkg Type	Min Qty	Case Qty	Price
<b>NICKEL-BRONZE RING &amp; COVER</b>					
822-C3DNQ	3" No-Hub - 5-7/8" Sqr Ring & Cover	BI	1	1	\$770.00
822-C3DNR	3" No-Hub - 5-1/2" Rnd Ring & Cover	BI	1	4	\$620.00
<b>STAINLESS STEEL RING &amp; COVER</b>					
822-C3DSQ	3" No-Hub - 5-7/8" Sqr Ring & Cover	BI	1	1	\$770.00
822-C3DSR	3" No-Hub - 5-1/2" Rnd Ring & Cover	BI	1	1	\$620.00

## FinishLine Halo™ Adjustable Cleanouts

### Cast Iron - No-Hub Connection

· Halo cleanout fixtures include 882-ST302 mechanical sealing plug

**Options:** Add suffix to item no. Add price to list

**V** = Vandal-Resistant Cover: \$23.00; **S** = Stamping: Specify Letters: \$75.00;

**C** = Carpet Marker: \$75.00; **Z** = Complies with Buy American Act (1): \$125.00;

1: For round nickel-bronze covers only



822-C3DF



834-3DHNR



822-CF3DNQ

Item Number	Item Description	Pkg Type	Min Qty	Case Qty	Price
<b>ROUGH-IN FIXTURE</b>					
822-C3DF	3" No-Hub	BI	1	1	\$360.00
<b>FINISH FIXTURE</b>					
834-3DHNQ	5-7/8" Sqr Nikl-Brnz Ring & Cover	BI	1	1	\$480.00
834-3DHNR	5-1/2" Rnd Nikl-Brnz Ring & Cover	BI	1	1	\$340.00
834-3DHSQ	5-7/8" Sqr Stnls Steel Ring & Cover	BI	1	1	\$480.00
834-3DHSR	5-1/2" Rnd Stnls Steel Ring & Cover	BI	1	1	\$340.00
<b>COMPLETE ASSEMBLY</b>					
822-CF3DNQ	3" No-Hub - 5-7/8" Sqr Nikl-Brnz Ring & Cover	BI	1	1	\$840.00
822-CF3DNR	3" No-Hub - 5-1/2" Rnd Nikl-Brnz Ring & Cover	BI	1	1	\$700.00
822-CF3DSQ	3" No-Hub - 5-7/8" Sqr Stnls Steel Ring & Cover	BI	1	1	\$840.00
822-CF3DSR	3" No-Hub - 5-1/2" Rnd Stnls Steel Ring & Cover	BI	1	1	\$700.00

**Cleanout Tees**

**Cast Iron - No-Hub Connection**

Item Number	Item Description	Pkg Type	Min Qty	Case Qty	Price
853-T23I	3" No-Hub w/ Brass Plug	BI	1	6	\$400.00
853-T24I	4" No-Hub w/ Brass Plug	BI	1	4	\$600.00
853-T26I	6" No-Hub w/ Brass Plug	BI	1	1	\$1,000.00
853-T28I	8" No-Hub w/ Brass Plug	BI	1	1	\$2,000.00



853-T24I

**Cleanout Ferrules**

**Cleanout Ferrules**

Item Number	Item Description	Pkg Type	Min Qty	Case Qty	Price
853-F23I	3" No-Hub w/ Brass Plug	BI	1	27	\$200.00
853-F24I	4" No-Hub w/ Brass Plug	BI	1	16	\$275.00
853-F26I	6" No-Hub w/ Brass Plug	BI	1	4	\$550.00



853-F23I

Supply

Drainage

Support

Specialties

Appendix

Supply

Drainage

Support

Specialties

Appendix



870-93

### Cleanout Covers

#### Heavy-Duty Stainless Steel

**Options:** Add suffix to item no. Add price to list  
**S** = Stamping: Specify Letters (1): \$75.00;

1: Not available for cast iron covers

Item Number	Item Description	Pkg Type	Min Qty	Case Qty	Price
<b>16-GA COVER</b>					
870-93	3" Diameter	BI	10	10	\$25.00
870-94	4" Diameter	BI	10	10	\$35.00
870-95	5" Diameter	BI	10	10	\$45.00
870-96	6" Diameter	BI	10	10	\$65.00
870-98	8" Diameter	BI	10	10	\$75.00

### Cleanout Cover Kits

#### Stainless Steel



873-8



873-36

Item Number	Item Description	Pkg Type	Min Qty	Case Qty	Price
<b>20-GA COVER WITH SCREW</b>					
873-10	10" Cover, 3-1/2" Screw	B	1	1	\$70.00
873-6	6" Cover, 3-1/2" Screw	BI	1	1	\$40.00
873-8	8" Cover, 3-1/2" Screw	BI	1	25	\$60.00
<b>20-GA COVER WITH SCREW AND BRASS PLUG</b>					
873-26	6" Cover, 2" Plug, 3-1/2" Screw	BI	1	1	\$90.00
873-356	6" Cover, 3-1/2" Plug, 3-1/2" Screw	BI	1	1	\$120.00
873-36	6" Cover, 3" Plug, 3-1/2" Screw	BI	1	1	\$100.00
873-48	8" Cover, 4" Plug, 3-1/2" Screw	BI	1	1	\$190.00
873-610	10" Cover, 6" Plug, 3-1/2" Screw	BI	1	1	\$500.00
873-810	10" Cover, 8" Plug, 3-1/2" Screw	BI	1	1	\$800.00

### Square Access Panels



971-99

Item Number	Item Description	Pkg Type	Min Qty	Case Qty	Price
971-77	7" x 7", Metal	B	1	8	\$800.00
971-99	9" x 9", Metal	B	1	8	\$1,200.00

**Brass - Slotted**

· Plugs are tapped 1/4"-20 for cover screw

Item Number	Item Description	Pkg Type	Min Qty	Case Qty	Price
876-SL15	1-1/2"	BI	10	10	\$40.00
876-SL20	2"	BI	10	10	\$50.00
876-SL25	2-1/2"	BI	10	10	\$60.00
876-SL30	3"	BI	10	40	\$100.00
876-SL35	3-1/2"	BI	10	10	\$150.00
876-SL40	4"	BI	10	10	\$200.00
876-SL60	6"	BI	10	10	\$400.00
876-SL80	8"	BI	10	10	\$700.00

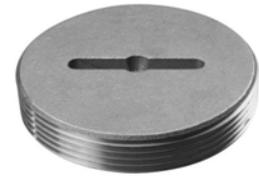

876-SL25

**Brass - Square-Head**

Item Number	Item Description	Pkg Type	Min Qty	Case Qty	Price
<b>RAISED SQUARE</b>					
876-RS15	1-1/2"	BI	10	10	\$25.00
876-RS20	2"	BI	10	10	\$35.00
876-RS25	2-1/2"	BI	10	10	\$40.00
876-RS30	3"	BI	10	10	\$45.00
876-RS35	3-1/2"	BI	10	10	\$60.00
876-RS40	4"	BI	10	10	\$70.00
876-RS50	5"	BI	10	10	\$120.00
876-RS60	6"	BI	10	10	\$225.00
876-RS80	8"	BI	10	10	\$600.00
<b>COUNTERSUNK SQUARE</b>					
876-CS15	1-1/2"	BI	10	10	\$25.00
876-CS20	2"	BI	10	10	\$35.00
876-CS25	2-1/2"	BI	10	10	\$40.00
876-CS30	3"	BI	10	10	\$45.00
876-CS35	3-1/2"	BI	10	10	\$60.00
876-CS40	4"	BI	10	10	\$70.00
876-CS60	6"	BI	10	10	\$225.00
876-CS80	8"	BI	10	10	\$600.00



876-RS30

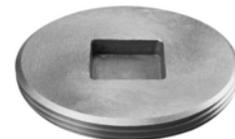

876-CS35

Supply

Drainage

Support

Specialties

Appendix





# Specification Fixture Carriers

**Water Closet Carriers**

**Lavatory Carriers**

**Urinal Carriers**

**Water-Cooler Carriers**

Floor-mounted Carriers and supports for commercial water closet and lavatory fixtures. Water closet carriers available for bariatric applications up to 1,000 lbs.

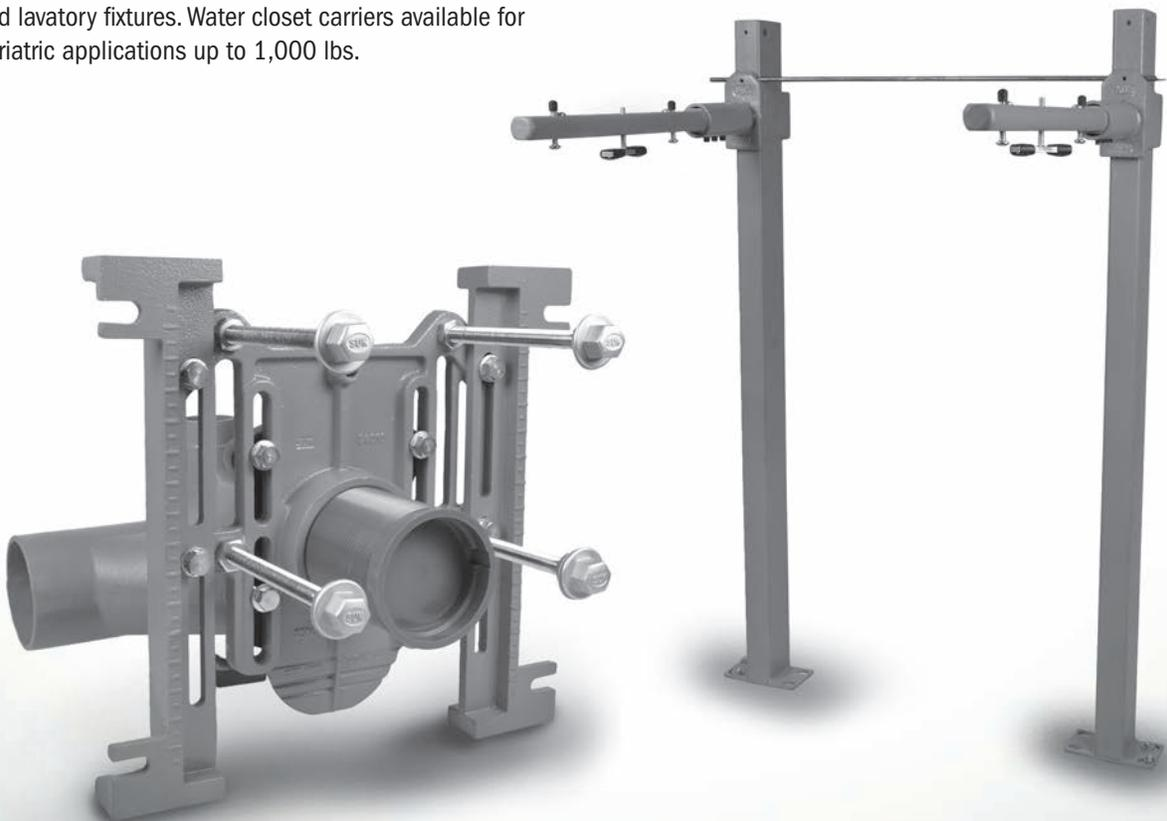



**837-HSR**  
Page 315

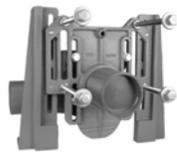

**837-HXR**  
Page 315

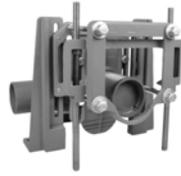

**837-HBR**  
Page 316



**837-VS10**  
Page 316



**837-VX10**  
Page 317



**837-VB10**  
Page 317



**837-7P**  
Page 320



**837-7D2**  
Page 321

 <p><b>837-VB10</b> Page 317</p>	 <p><b>837-7P</b> Page 320</p>	 <p><b>837-7D2</b> Page 321</p>		

**Horizontal**

**Standard (500 Lb)**

**Options:** Add suffix to item no. Add price to list  
 T = 12" ABS Threaded Coupling (1): N/C;

1: In lieu of 6" coupling (standard)

**Related Products**

Carrier Bracket p 537

Item Number	Item Description	Pkg Type	Min Qty	Case Qty	Price
<b>STANDARD</b>					
837-HSD	4" No-Hub, Double	B	1	1	\$3,600.00
837-HSL	4" No-Hub, Left	B	1	1	\$2,000.00
837-HSR	4" No-Hub, Right	B	1	1	\$2,000.00
<b>WIDE CHASE</b>					
837-HSDW	4" No-Hub, Double	B	1	1	\$4,600.00
837-HSLW	4" No-Hub, Left	B	1	1	\$2,400.00
837-HSRW	4" No-Hub, Right	B	1	1	\$2,400.00



837-HSR



837-HSRW

**Horizontal**

**Extra-Heavy (750 Lb)**

**Options:** Add suffix to item no. Add price to list  
 T = 12" ABS Threaded Coupling (1): N/C;

1: In lieu of 6" coupling (standard)

Item Number	Item Description	Pkg Type	Min Qty	Case Qty	Price
837-HXD	4" No-Hub, Double	B	1	1	\$7,100.00
837-HXL	4" No-Hub, Left	B	1	1	\$4,000.00
837-HXR	4" No-Hub, Right	B	1	1	\$4,000.00

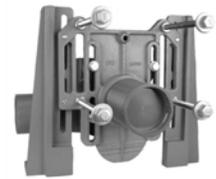

837-HXR

Supply

Drainage

Support

Specialties

Appendix

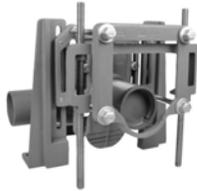

837-HBR

### Horizontal Bariatric (1,000 Lb)

**Options:** Add suffix to item no. Add price to list  
T = 12" ABS Threaded Coupling (1): N/C;

1: In lieu of 6" coupling (standard)

Item Number	Item Description	Pkg Type	Min Qty	Case Qty	Price
837-HBD	4" No-Hub, Double	B	1	1	\$9,550.00
837-HBL	4" No-Hub, Left	B	1	1	\$5,800.00
837-HBR	4" No-Hub, Right	B	1	1	\$5,800.00

### Vertical Standard (500 Lb)

**Options:** Add suffix to item no. Add price to list  
T = 12" ABS Threaded Coupling (1): N/C;

1: In lieu of 6" coupling (standard)



837-VS10



837-VS10W

Item Number	Item Description	Pkg Type	Min Qty	Case Qty	Price
<b>STANDARD</b>					
837-VS10	4" No-Hub, No-Side Inlet	B	1	1	\$2,200.00
837-VS12	4" No-Hub, 2 Side Inlets	B	1	1	\$2,200.00
837-VS1L	4" No-Hub, Left Side Inlet	B	1	1	\$2,200.00
837-VS1R	4" No-Hub, Right Side Inlet	B	1	1	\$2,200.00
837-VS20	4" No-Hub, No-Side Inlet, Double	B	1	1	\$3,900.00
837-VS21	4" No-Hub, 1 Side Inlet, Double	B	1	1	\$3,900.00
837-VS22	4" No-Hub, 2 Side Inlets Double	B	1	1	\$3,900.00
<b>WIDE CHASE</b>					
837-VS10W	4" No-Hub, No-Side Inlet	B	1	1	\$2,500.00
837-VS12W	4" No-Hub, Two Side Inlets	B	1	1	\$2,500.00
837-VS1LW	4" No-Hub, Left Side Inlet	B	1	1	\$2,500.00
837-VS1RW	4" No-Hub, Right Side Inlet	B	1	1	\$2,500.00
837-VS20W	4" No-Hub, No-Side Inlet, Double	B	1	1	\$4,500.00
837-VS21W	4" No-Hub, 1 Side Inlet, Double	B	1	1	\$4,500.00
837-VS22W	4" No-Hub, 2 Side Inlets Double	B	1	1	\$4,500.00

**Vertical**

**Extra-Heavy (750 Lb)**

**Options:** Add suffix to item no. Add price to list

T = 12" ABS Threaded Coupling (1): N/C;

1: In lieu of 6" coupling (standard)



837-VX10

Item Number	Item Description	Pkg Type	Min Qty	Case Qty	Price
<b>SINGLE</b>					
837-VX10	4" No-Hub, No-Side Inlet	B	1	1	\$4,600.00
837-VX12	4" No-Hub, 2 Side Inlets	B	1	1	\$4,600.00
837-VX1L	4" No-Hub, Left Side Inlet	B	1	1	\$4,600.00
837-VX1R	4" No-Hub, Right Side Inlet	B	1	1	\$4,600.00
<b>DOUBLE</b>					
837-VX20	4" No-Hub, No-Side Inlet, Double	B	1	1	\$9,000.00
837-VX21	4" No-Hub, 1 Side Inlet, Double	B	1	1	\$9,000.00
837-VX22	4" No-Hub, 2 Side Inlets Double	B	1	1	\$9,000.00

**Vertical**

**Bariatric (1,000 Lb)**

**Options:** Add suffix to item no. Add price to list

T = 12" ABS Threaded Coupling (1): N/C;

1: In lieu of 6" coupling (standard)



837-VB10

Item Number	Item Description	Pkg Type	Min Qty	Case Qty	Price
<b>SINGLE</b>					
837-VB10	4" No-Hub, No-Side Inlet	B	1	1	\$6,300.00
837-VB12	4" No-Hub, 2 Side Inlets	B	1	1	\$6,300.00
837-VB1L	4" No-Hub, Left Side Inlet	B	1	1	\$6,300.00
837-VB1R	4" No-Hub, Right Side Inlet	B	1	1	\$6,300.00
<b>DOUBLE</b>					
837-VB20	4" No-Hub, No-Side Inlet, Double	B	1	1	\$12,500.00
837-VB21	4" No-Hub, 1 Side Inlet, Double	B	1	1	\$12,500.00
837-VB22	4" No-Hub, 2 Side Inlets Double	B	1	1	\$12,500.00

**Closet Carrier Accessories**

Item Number	Item Description	Pkg Type	Min Qty	Case Qty	Price
<b>WC CARRIER COUPLINGS</b>					
837-06	4" ABS Threaded WC Coupling - 6" Long	BI	1	1	\$60.00
837-12	4" ABS Threaded WC Coupling - 12" Long	BI	1	1	\$60.00

Supply

Drainage

Support

Specialties

Appendix

**Closet Carrier Accessories (Cont)**

Item Number	Item Description	Pkg Type	Min Qty	Case Qty	Price
<b>FACE PLATE ASSEMBLY KIT</b>					
837-FPA	WC Carrier Faceplate Assembly Kit - Standard	BI	1	1	\$1,350.00
837-FPAH	WC Carrier Faceplate Assembly Kit - Heavy-Duty	BI	1	1	\$1,435.00
<b>TILING FRAME</b>					
837-TF	Finish Tiling Frame for Closet Carrier - ABS	BI	1	20	\$120.00
<b>SUPPORT LEGS &amp; ANCHORS</b>					
837-LEG	Standard Leg Support (1) for WC Carrier Faceplate - Reversible	BI	1	1	\$205.00
837-LEGHL	Heavy-Duty Leg Support for WC Carrier Faceplate - Left	BI	1	1	\$235.00
837-LEGHR	Heavy-Duty Leg Support for WC Carrier Faceplate - Right	BI	1	1	\$235.00
837-RA	Rear Anchor Support Kit for WC Carrier - Standard	BI	1	35	\$160.00
<b>HARDWARE PACKS</b>					
837-FH	Finish Hardware Pack for WC Carrier	BI	1	30	\$160.00
837-RH	Rough-in Hardware Pack for WC Carrier	BI	1	35	\$160.00
837-TR	Thread Rod & Sleeve Pack for WC Carrier	BI	1	15	\$80.00



837-FPA



837-TF

Supply

Drainage

Support

Specialties

Appendix

**Concealed Arm**

**Options:** Add suffix to item no. Add price to list

**B** = Back-to-Back Carrier: \$500.00;

Item Number	Item Description	Pkg Type	Min Qty	Case Qty	Price
837-7C15	Lavatory Carrier, 15" Concealed Arm	B	1	1	\$1,230.00
837-7C18	Lavatory Carrier, 18" Concealed Arm	B	1	1	\$1,230.00
837-7C22	Lavatory Carrier, 22" Concealed Arm	B	1	1	\$1,230.00



837-7C15

**Adjustable Concealed Arm**

**Options:** Add suffix to item no. Add price to list

**B** = Back-to-Back Carrier: \$500.00;

Item Number	Item Description	Pkg Type	Min Qty	Case Qty	Price
837-7CA15	Lavatory Carrier, 15" Adjustable Concealed Arm	B	1	1	\$1,538.00
837-7CA18	Lavatory Carrier, 18" Adjustable Concealed Arm	B	1	1	\$1,538.00
837-7CA22	Lavatory Carrier, 22" Adjustable Concealed Arm	B	1	1	\$1,538.00



**Plate Type**

**Options:** Add suffix to item no. Add price to list

**B** = Back-to-Back Carrier: \$500.00;

Item Number	Item Description	Pkg Type	Min Qty	Case Qty	Price
<b>CARRIER</b>					
837-7PL	Fixture Carrier, Single-Plate Type For Lavatory	B	1	1	\$900.00
<b>WALL PLATE</b>					
837-7W	Fixture Carrier, Wall Plate for Lavatory / Urinal / Water Cooler	B	1	1	\$275.00



837-7PL



837-7W

Supply

Drainage

Support

Specialties

Appendix

Supply

Drainage

Support

Specialties

Appendix



837-7D



837-7P

### Plate Type

Item Number	Item Description	Pkg Type	Min Qty	Case Qty	Price
<b>CARRIER</b>					
837-7D	Fixture Carrier, Dual-Plate Type For Urinal	B	1	1	\$1,025.00
837-7P	Fixture Carrier, Single-Plate Type For Urinal	B	1	1	\$925.00
<b>WALL PLATE</b>					
837-7W	Fixture Carrier, Wall Plate for Lavatory / Urinal / Water Cooler	B	1	1	\$275.00



Plate Type

Item Number	Item Description	Pkg Type	Min Qty	Case Qty	Price
<b>SINGLE</b>					
837-7DC	Fixture Carrier, Dual-Plate Type For Water Cooler	B	1	1	\$1,025.00
837-7PC	Fixture Carrier, Single-Plate Type For Water Cooler	B	1	1	\$925.00
<b>SIDE-BY-SIDE</b>					
837-7D2	Fixture Carrier, SxS Dual-Plate Type For Water Cooler	B	1	1	\$1,400.00
837-7P2	Fixture Carrier, SxS Single-Plate Type For Water Cooler	B	1	1	\$1,230.00
<b>WALL PLATE</b>					
837-7W	Fixture Carrier, Wall Plate for Lavatory / Urinal / Water Cooler	B	1	1	\$275.00



837-7DC



837-7PC



837-7D2



837-7P2

Supply

Drainage

Support

Specialties

Appendix



# **Commercial Drainage**

**Floor Drains**

**Floor Sinks**

**Roof Drains**

**Cleanouts**

# Commercial Drainage

## Floor Drains

Adjustable and non-adjustable floor drains for on-grade and above-grade applications. Cast iron, PVC and ABS connections available. Designed in accordance with ASME A112.6.3 Standard for Floor and Trench Drains.

**Note:** All floor drains installed in above-grade applications must be leak tested for watertightness according to local codes and standards. Failure to do so will void the warranty.

## Floor Sinks

PVC floor sinks designed for direct or indirect waste applications.

Designed in accordance with ASME A112.6.7 Standard for Sanitary Floor Sinks.

**Note:** All floor sinks installed in above-grade applications must be leak tested for watertightness according to local codes and standards. Failure to do so will void the warranty.

## Roof Drains

Roof drain, overflow, scupper and accessory fixtures available with PVC and ABS connections.

Designed in accordance with ASME A112.6.4 Standard for Roof, Deck, and Balcony Drains.

**Note:** All roof drains must be leak tested for watertightness according to local codes and standards. Failure to do so will void the warranty.

## Cleanouts

Adjustable and non-adjustable cleanout fixtures provide access to drain lines. PVC and ABS connections available. Designed in accordance with ASME A112.36.2M Standard for Cleanouts.

**Note:** All roof drains must be leak tested for watertightness according to local codes and standards. Failure to do so will void the warranty.

# Commercial Floor Drains

**FinishLine™ On-Grade Floor Drains**

**FatMax™ Floor Drains**

**FinishLine™ Above-Grade Floor Drains**

**Halo™ Floor Drains**

**Floor Drain Accessories**



Sioux Chief's FinishLine™ Floor drain system is adjustable both before and AFTER the concrete pour.

The FinishLine virtually eliminates drains set too low or not level. Installations that are faster, easier, and more professional looking.



**832-2PNQ**  
Page 327



**832-35ASR**  
Page 329



**842-36PI**  
Page 330



**842-36LP**  
Page 331



**843-2PNR**  
Page 332



**860-2AZ**  
Page 333



**864-2P**  
Page 334



**833-2PSR**  
Page 335



**833-35ANR**  
Page 337



**833-22NR**  
Page 338



**833-235SR**  
Page 339



**833-62NR**  
Page 340



**833-625NQ**  
Page 342



**863-42NQ**  
Page 343



**863-325NR**  
Page 344



**863-24NQ**  
Page 345



**863-64NQ**  
Page 346



**822-2PSQ**  
Page 347



**822-F2ANR**  
Page 348



**842-SNQ3**  
Page 350



**842-SP2**  
Page 350



**842-82PT**  
Page 351



**863-HP23**  
Page 351



**850-VW1**  
Page 352

**PVC/ABS - Sch. 40 Hub Connection**

**6-1/2" Tops**

**Options:** Add suffix to item no. Add price to list

**V** = Vandal-Resistant Strainer: \$6.50; **H** = Hinged Strainer: \$16.00;

**E** = Extended Ring (1): \$78.00; **B** = Complies with Buy American Act (1): \$62.00;

1: For round nickel bronze ring/strainer only

Item Number	Item Description	Pkg Type	Min Qty	Case Qty	Price
<b>ROUGH-IN FIXTURE</b>					
832-2AF	2" ABS Hub	Bl	1	10	\$23.95
832-2PF	2" PVC Hub	Bl	1	10	\$23.95
832-36AF	3" ABS Hub	Bl	1	10	\$23.95
832-36PF	3" PVC Hub	Bl	1	10	\$23.95
832-4AF	4" ABS Hub	Bl	1	10	\$23.95
832-4PF	4" PVC Hub	Bl	1	10	\$23.95
<b>FINISH FIXTURE</b>					
832-4HHD	6-1/2" Hub Drain Finish Fixture	Bl	1	10	\$18.91
832-4HNQ	7" Sqr Nikl-Brnz Ring & Strainer	Bl	1	10	\$96.41
832-4HNR	6-1/2" Rnd Nikl-Brnz Ring & Strainer	Bl	1	10	\$64.92
832-4HPR	6-1/2" Rnd Gray ABS Ring & Strainer	Bl	1	10	\$34.63
832-4HSQ	7" Sqr Stnls Steel Ring & Strainer	Bl	1	1	\$96.41
832-4HSR	6-1/2" Rnd Stnls Steel Ring & Strainer	Bl	1	10	\$64.92
<b>COMPLETE ASSEMBLY</b>					
832-2ANQ	2" ABS Hub - 7" Sqr Nikl-Brnz Ring & Strainer	Bl	1	1	\$120.36
832-2ANR	2" ABS Hub - 6-1/2" Rnd Nikl-Brnz Ring & Strainer	Bl	1	1	\$88.87
<b>832-2ASQ</b>	2" ABS Hub - 7" Sqr Stnls Steel Ring & Strainer	Bl	1	1	\$120.36
<b>832-2ASR</b>	2" ABS Hub - 6-1/2" Rnd Stnls Steel Ring & Strainer	Bl	1	1	\$88.87
832-2PNQ	2" PVC Hub - 7" Sqr Nikl-Brnz Ring & Strainer	Bl	1	1	\$120.36
832-2PNR	2" PVC Hub - 6-1/2" Rnd Nikl-Brnz Ring & Strainer	Bl	1	1	\$88.87
832-2PSQ	2" PVC Hub - 7" Sqr Stnls Steel Ring & Strainer	Bl	1	1	\$120.36
<b>832-2PSR</b>	2" PVC Hub - 6-1/2" Rnd Stnls Steel Ring & Strainer	Bl	1	1	\$88.87
<b>832-36ANQ</b>	3" ABS Hub - 7" Sqr Nikl-Brnz Ring & Strainer	Bl	1	1	\$120.36
832-36ANR	3" ABS Hub - 6-1/2" Rnd Nikl-Brnz Ring & Strainer	Bl	1	1	\$88.87
<b>832-36ASQ</b>	3" ABS Hub - 7" Sqr Stnls Steel Ring & Strainer	Bl	1	1	\$120.36
<b>832-36ASR</b>	3" ABS Hub - 6-1/2" Rnd Stnls Steel Ring & Strainer	Bl	1	1	\$88.87
832-36PNQ	3" PVC Hub - 7" Sqr Nikl-Brnz Ring & Strainer	Bl	1	1	\$120.36
832-36PNR	3" PVC Hub - 6-1/2" Rnd Nikl-Brnz Ring & Strainer	Bl	1	1	\$88.87
<b>832-36PSQ</b>	3" PVC Hub - 7" Sqr Stnls Steel Ring & Strainer	Bl	1	1	\$120.36
832-36PSR	3" PVC Hub - 6-1/2" Rnd Stnls Steel Ring & Strainer	Bl	1	1	\$88.87
<b>832-4ANQ</b>	4" ABS Hub - 7" Sqr Nikl-Brnz Ring & Strainer	Bl	1	1	\$120.36
<b>832-4ANR</b>	4" ABS Hub - 6-1/2" Rnd Nikl-Brnz Ring & Strainer	Bl	1	1	\$88.87
<b>832-4ASQ</b>	4" ABS Hub - 7" Sqr Stnls Steel Ring & Strainer	Bl	1	1	\$120.36
<b>832-4ASR</b>	4" ABS Hub - 6-1/2" Rnd Stnls Steel Ring & Strainer	Bl	1	1	\$88.87
832-4PNQ	4" PVC Hub - 7" Sqr Nikl-Brnz Ring & Strainer	Bl	1	1	\$120.36



Supply

Drainage

Support

Specialties

Appendix

Supply

Drainage

Support

Specialties

Appendix



832-2PNQ

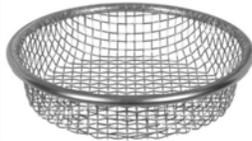

832-UM

### PVC/ABS - Sch. 40 Hub Connection (Cont)

#### 6-1/2" Tops

Item Number	Item Description	Pkg Type	Min Qty	Case Qty	Price
<b>COMPLETE ASSEMBLY</b>					
832-4PNR	4" PVC Hub - 6-1/2" Rnd Nikl-Brnz Ring & Strainer	BI	1	1	\$88.87
<b>832-4PSQ</b>	4" PVC Hub - 7" Sqr Stnls Steel Ring & Strainer	BI	1	1	\$120.36
832-4PSR	4" PVC Hub - 6-1/2" Rnd Stnls Steel Ring & Strainer	BI	1	1	\$88.87
<b>ACCESSORIES</b>					
832-EX4	Ductile Iron Extension Adapter - 2" Min - 4" Max	BI	1	1	\$34.14
832-P	Coring Plug Wrench	BI	1	1	\$24.65
832-S4	Two Adjustment Shims, Two 3/4" Screws	BI	10	10	\$6.10
832-UM	4-1/4" Stainless Steel Debris Basket	BI	1	15	\$21.43
832-W	Flexible Red Locating Bristles w/ Screw	BI	10	10	\$7.26
835-2	Trapshield™ For 2" Drain Outlet	BI	1	50	\$56.31
835-3	Trapshield™ For 3" Drain Outlet	BI	1	25	\$63.36
835-4	Trapshield™ For 4" Drain Outlet	BI	1	20	\$74.98
863-FA	Round Aluminum Condensate Funnel w/ Screws	BI	1	12	\$49.15
863-FN	Round Nikl-Brnz Condensate Funnel w/ Screws	BI	1	12	\$109.99
863-FNO	Oval Nikl-Brnz Condensate Funnel w/ Screws	BI	1	12	\$243.96

### PVC/ABS - Sch. 40 Hub Connection

#### 5-1/2" Tops

**Options:** Add suffix to item no. Add price to list

V = Vandal-Resistant Strainer: \$6.50; B = Complies with Buy American Act (1): \$62.00;

E = Extended Ring (1): \$78.00;

1: For round nickel bronze ring/strainer only



832-25PF



832-3HNQ



832-35ASR

Item Number	Item Description	Pkg Type	Min Qty	Case Qty	Price
<b>ROUGH-IN FIXTURE</b>					
832-25AF	2" ABS Hub	BI	1	10	\$19.55
832-25PF	2" PVC Hub	BI	1	10	\$19.55
832-35AF	3" ABS Hub	BI	1	10	\$19.55
832-35PF	3" PVC Hub	BI	1	10	\$19.55
<b>FINISH FIXTURE</b>					
832-3HHD	5-1/2" Hub Drain Finish Fixture	BI	1	10	\$15.64
832-3HNQ	5-7/8" Sqr Nikl-Brnz Ring & Strainer	BI	1	10	\$68.00
832-3HNR	5-1/2" Rnd Nikl-Brnz Ring & Strainer	BI	1	10	\$48.00
832-3HS	5-1/2" Rnd 18-Ga Stnls Steel Strainer	B	1	20	\$19.80
<b>832-3HSQ</b>	5-7/8" Sqr Stnls Steel Ring & Strainer	BI	1	10	\$68.00
832-3HSR	5-1/2" Rnd Stnls Steel Ring & Strainer	BI	1	10	\$48.00



**PVC/ABS - Sch. 40 Hub Connection (Cont)**

**5-1/2" Tops**



832-EPS3

Item Number	Item Description	Pkg Type	Min Qty	Case Qty	Price
<b>COMPLETE ASSEMBLY</b>					
832-25ANQ	2" ABS Hub - 5-7/8" Sqr Nikl-Brnz Ring & Strainer	Bl	1	1	\$85.11
832-25ANR	2" ABS Hub - 5-1/2" Rnd Nikl-Brnz Ring & Strainer	Bl	1	1	\$66.19
832-25ASQ	2" ABS Hub - 5-7/8" Sqr Stnls Steel Ring & Strainer	Bl	1	1	\$85.11
832-25ASR	2" ABS Hub - 5-1/2" Rnd Stnls Steel Ring & Strainer	Bl	1	1	\$66.19
832-25PNQ	2" PVC Hub - 5-7/8" Sqr Nikl-Brnz Ring & Strainer	Bl	1	1	\$85.11
832-25PNR	2" PVC Hub - 5-1/2" Rnd Nikl-Brnz Ring & Strainer	Bl	1	1	\$66.19
832-25PSQ	2" PVC Hub - 5-7/8" Sqr Stnls Steel Ring & Strainer	Bl	1	1	\$85.11
832-25PSR	2" PVC Hub - 5-1/2" Rnd Stnls Steel Ring & Strainer	Bl	1	1	\$66.19
832-35ANQ	3" ABS Hub - 5-7/8" Sqr Nikl-Brnz Ring & Strainer	Bl	1	1	\$85.11
832-35ANR	3" ABS Hub - 5-1/2" Rnd Nikl-Brnz Ring & Strainer	Bl	1	1	\$66.19
832-35ASQ	3" ABS Hub - 5-7/8" Sqr Stnls Steel Ring & Strainer	Bl	1	1	\$85.11
832-35ASR	3" ABS Hub - 5-1/2" Rnd Stnls Steel Ring & Strainer	Bl	1	1	\$66.19
832-35PNQ	3" PVC Hub - 5-7/8" Sqr Nikl-Brnz Ring & Strainer	Bl	1	1	\$85.11
832-35PNR	3" PVC Hub - 5-1/2" Rnd Nikl-Brnz Ring & Strainer	Bl	1	1	\$66.19
832-35PSQ	3" PVC Hub - 5-7/8" Sqr Stnls Steel Ring & Strainer	Bl	1	1	\$85.11
832-35PSR	3" PVC Hub - 5-1/2" Rnd Stnls Steel Ring & Strainer	Bl	1	1	\$66.19
<b>ACCESSORIES</b>					
822-EX3	Ductile Iron Extension Adapter	B	1	1	\$35.33
832-EPS3	Extended ABS Coring Sleeve & Plug	Bl	1	10	\$15.82
832-EX3	Ductile Iron Extension Adapter - 2" Min - 3-3/8" Max	Bl	1	1	\$34.14
832-P	Coring Plug Wrench	Bl	1	1	\$24.65
832-S3	Two Adjustment Shims, Two 3/4" Screws	Bl	10	10	\$6.10
832-W	Flexible Red Locating Bristles w/ Screw	Bl	10	10	\$7.26
835-2	Trapshield™ For 2" Drain Outlet	Bl	1	50	\$56.31
835-3	Trapshield™ For 3" Drain Outlet	Bl	1	25	\$63.36
863-FA	Round Aluminum Condensate Funnel w/ Screws	Bl	1	12	\$49.15
863-FN	Round Nikl-Brnz Condensate Funnel w/ Screws	Bl	1	12	\$109.99
863-FNO	Oval Nikl-Brnz Condensate Funnel w/ Screws	Bl	1	12	\$243.96

Supply

Drainage

Support

Specialties

Appendix

**Adjustable Floor Drain**

**PVC/ABS - Sch. 40 Hub Connection**

**Options:** Add suffix to item no. Add price to list

**V** = Vandal-Resistant Strainer: \$6.50; **H** = Hinged Strainer (1): \$16.00;

**E** = Extended Ring (2): \$78.00; **B** = Complies with Buy American Act (2): \$65.00;

**Y** = Ductile Iron Head Adapter (3): \$26.00; **M** = Medium-Duty Strainer (3,000 lbs. safe-load) (4): \$39.00;

1: For 6-1/2" and 7" nickel-bronze or SS304 ring/strainer only 2: For round nickel bronze ring/strainer only 3: In lieu of ABS (standard) 4: For 6-1/2" round SS 304 ring/strainer only



842-2ANR



842-36PSQ



842-36PI

Item Number	Item Description	Pkg Type	Min Qty	Case Qty	Price
<b>NICKEL-BRONZE RING &amp; STRAINER</b>					
<b>842-2ANQ</b>	2" ABS Hub - 5-7/8" Sqr Ring & Strainer	BI	1	1	\$90.48
842-2ANR	2" ABS Hub - 5-1/2" Rnd Ring & Strainer	BI	1	10	\$68.76
842-2PNQ	2" PVC Hub - 5-7/8" Sqr Ring & Strainer	BI	1	10	\$90.48
842-2PNR	2" PVC Hub - 5-1/2" Rnd Ring & Strainer	BI	1	10	\$68.76
<b>842-36ANQ</b>	3" ABS Hub - 7" Sqr Ring & Strainer	BI	1	1	\$119.43
<b>842-36ANR</b>	3" PVC Hub - 6-1/2" Rnd Ring & Strainer	BI	1	1	\$83.25
842-36PNQ	3" PVC Hub - 7" Sqr Ring & Strainer	BI	1	10	\$119.43
842-36PNR	3" PVC Hub - 6-1/2" Rnd Ring & Strainer	BI	1	10	\$83.25
<b>842-3ANQ</b>	3" ABS Hub - 5-7/8" Sqr Ring & Strainer	BI	1	1	\$90.48
842-3ANR	3" PVC Hub - 5-1/2" Rnd Ring & Strainer	BI	1	8	\$68.76
842-3PNQ	3" PVC Hub - 5-7/8" Sqr Ring & Strainer	BI	1	10	\$90.48
842-3PNR	3" PVC Hub - 5-1/2" Rnd Ring & Strainer	BI	1	8	\$68.76
<b>842-4ANQ</b>	4" ABS Hub - 7" Sqr Ring & Strainer	BI	1	1	\$119.43
842-4ANR	4" ABS Hub - 6-1/2" Rnd Ring & Strainer	BI	1	10	\$83.25
<b>842-4PNQ</b>	4" PVC Hub - 7" Sqr Ring & Strainer	BI	1	10	\$119.43
842-4PNR	4" PVC Hub - 6-1/2" Rnd Ring & Strainer	BI	1	10	\$83.25
<b>STAINLESS STEEL RING &amp; STRAINER</b>					
<b>842-2ASQ</b>	2" ABS Hub - 5-7/8" Sqr Ring & Strainer	BI	1	1	\$90.48
<b>842-2ASR</b>	2" ABS Hub - 5-1/2" Rnd Ring & Strainer	BI	1	1	\$68.76
842-2PSQ	2" PVC Hub - 5-7/8" Sqr Ring & Strainer	BI	1	10	\$90.48
842-2PSR	2" PVC Hub - 5-1/2" Rnd Ring & Strainer	BI	1	10	\$68.76
<b>842-36ASQ</b>	3" ABS Hub - 7" Sqr Ring & Strainer	BI	1	1	\$119.43
<b>842-36ASR</b>	3" PVC Hub - 6-1/2" Rnd Ring & Strainer	BI	1	1	\$83.25
<b>842-36PSQ</b>	3" PVC Hub - 7" Sqr Ring & Strainer	BI	1	1	\$119.43
842-36PSR	3" PVC Hub - 6-1/2" Rnd Ring & Strainer	BI	1	10	\$83.25
<b>842-3ASQ</b>	3" ABS Hub - 5-7/8" Sqr Ring & Strainer	BI	1	1	\$90.48
<b>842-3ASR</b>	3" PVC Hub - 5-1/2" Rnd Ring & Strainer	BI	1	1	\$68.76
842-3PSQ	3" PVC Hub - 5-7/8" Sqr Ring & Strainer	BI	1	10	\$90.48
842-3PSR	3" PVC Hub - 5-1/2" Rnd Ring & Strainer	BI	1	8	\$68.76
<b>842-4ASQ</b>	4" ABS Hub - 7" Sqr Ring & Strainer	BI	1	1	\$119.43
<b>842-4ASR</b>	4" ABS Hub - 6-1/2" Rnd Ring & Strainer	BI	1	1	\$83.25
842-4PSQ	4" PVC Hub - 7" Sqr Ring & Strainer	BI	1	1	\$119.43
842-4PSR	4" PVC Hub - 6-1/2" Rnd Ring & Strainer	BI	1	10	\$83.25
<b>CAST IRON RING &amp; STRAINER</b>					
<b>842-36PI</b>	3" PVC Hub - 6-5/8" Rnd Ring & Strainer	BI	1	2	\$67.74
842-4PI	4" PVC Hub - 6-5/8" Rnd Ring & Strainer	BI	1	2	\$67.74

Supply

Drainage

Support

Specialties

Appendix

**Adjustable Floor Drain (Cont)**

**PVC/ABS - Sch. 40 Hub Connection**

Item Number	Item Description	Pkg Type	Min Qty	Case Qty	Price
<b>ACCESSORIES</b>					
835-2	Trapshield™ For 2" Drain Outlet	Bl	1	50	\$56.31
835-3	Trapshield™ For 3" Drain Outlet	Bl	1	25	\$63.36
835-35	Trapshield™ For 3-1/2" Drain Head	Bl	1	25	\$63.36
835-4	Trapshield™ For 4" Drain Outlet	Bl	1	20	\$74.98
842-UM	4-5/8" Stainless Steel Debris Basket	Bl	1	10	\$21.67
863-FA	Round Aluminum Condensate Funnel w/ Screws	Bl	1	12	\$49.15
863-FN	Round Nikl-Brnz Condensate Funnel w/ Screws	Bl	1	12	\$109.99
863-FNO	Oval Nikl-Brnz Condensate Funnel w/ Screws	Bl	1	12	\$243.96



863-FA

**Adjustable Floor Drain Head**

**ABS - MIP Thread Connection**

**Options:** Add suffix to item no. Add price to list

**V** = Vandal-Resistant Strainer: \$6.50; **H** = Hinged Strainer (1): \$16.00;

**E** = Extended Ring (2): \$78.00; **M** = Medium-Duty Strainer (3,000 lbs. safe-load) (3): \$39.00;

1: For 6-1/2" and 7" nickel-bronze or SS304 ring/strainer only 2: For 5-1/2" and 6-1/2" round nickel bronze ring/strainer only 3: For 6-1/2" round SS 304 ring/strainer only

Item Number	Item Description	Pkg Type	Min Qty	Case Qty	Price
<b>NICKEL-BRONZE RING &amp; STRAINER</b>					
842-2LNQ	2" MIP - 4-1/2" Sqr Ring & Strainer	Bl	1	5	\$65.15
842-2LNR	2" MIP - 4-1/2" Rnd Ring & Strainer	Bl	1	10	\$50.67
842-36LNQ	3" MIP - 7" Sqr Ring & Strainer	Bl	1	5	\$108.57
842-36LNR	3" MIP - 6-1/2" Rnd Ring & Strainer	Bl	1	10	\$72.38
842-3LNQ	3" MIP - 5-7/8" Sqr Ring & Strainer	Bl	1	5	\$90.48
842-3LNR	3" MIP - 5-1/2" Rnd Ring & Strainer	Bl	1	10	\$68.76
842-3LNRPK	3" MIP - 5-1/2" Rnd Ring & Strainer	Cl	5	5	\$69.76
<b>842-4LNQ</b>	4" MIP - 7" Sqr Ring & Strainer	Bl	1	5	\$119.43
842-4LNR	4" MIP - 6-1/2" Rnd Ring & Strainer	Bl	1	10	\$83.25
<b>STAINLESS STEEL RING &amp; STRAINER</b>					
<b>842-2LSQ</b>	2" MIP - 4-1/2" Sqr Ring & Strainer	Bl	1	1	\$65.15
842-2LSR	2" MIP - 4-1/2" Rnd Ring & Strainer	Bl	1	1	\$50.67
<b>842-36LSQ</b>	3" MIP - 7" Sqr Ring & Strainer	Bl	1	1	\$108.57
842-36LSR	3" MIP - 6-1/2" Rnd Ring & Strainer	Bl	1	10	\$72.38
842-3LSQ	3" MIP - 5-7/8" Sqr Ring & Strainer	Bl	1	5	\$90.48
842-3LSR	3" MIP - 5-1/2" Rnd Ring & Strainer	Bl	1	10	\$68.76
<b>842-4LSQ</b>	4" MIP - 7" Sqr Ring & Strainer	Bl	1	1	\$119.43
842-4LSR	4" MIP - 6-1/2" Rnd Ring & Strainer	Bl	1	10	\$83.25
<b>GRAY ABS STRAINER</b>					
842-2LP	2" MIP - 4-3/8" Rnd Ring & Strainer	Bl	1	10	\$28.96
<b>842-36LP</b>	3" MIP - 6-1/2" Rnd Ring & Strainer	Bl	1	1	\$36.19
842-3LP	3" MIP - 5-1/2" Rnd Ring & Strainer	Bl	1	10	\$39.81
842-4LP	4" MIP - 6-1/2" Rnd Ring & Strainer	Bl	1	10	\$47.05



842-2LNQ



842-36LP

Supply

Drainage

Support

Specialties

Appendix



863-FNO

### Adjustable Floor Drain Head (Cont)

#### ABS - MIP Thread Connection

Item Number	Item Description	Pkg Type	Min Qty	Case Qty	Price
<b>ACCESSORIES</b>					
832-UM	4-1/4" Stainless Steel Debris Basket	BI	1	15	\$21.43
863-FA	Round Aluminum Condensate Funnel w/ Screws	BI	1	12	\$49.15
863-FN	Round Nikl-Brnz Condensate Funnel w/ Screws	BI	1	12	\$109.99
863-FNO	Oval Nikl-Brnz Condensate Funnel w/ Screws	BI	1	12	\$243.96

### Non-Adjustable Floor Drain

#### PVC/ABS - Sch. 40 Hub Connection

**Options:** Add suffix to item no. Add price to list  
 V = Vandal-Resistant Strainer: \$6.50;



843-2PNR



843-2PS



843-2PP

Item Number	Item Description	Pkg Type	Min Qty	Case Qty	Price
<b>NICKEL-BRONZE RING &amp; STRAINER</b>					
<b>843-2ANQ</b>	2" ABS Hub - 4-1/2" Sqr Ring & Strainer	BI	1	1	\$68.76
843-2ANR	2" ABS Hub - 4-1/2" Rnd Ring & Strainer	BI	1	10	\$54.29
843-2PNQ	2" PVC Hub - 4-1/2" Sqr Ring & Strainer	BI	1	5	\$68.76
843-2PNR	2" PVC Hub - 4-1/2" Rnd Ring & Strainer	BI	1	10	\$54.29
843-3ANQ	3" ABS Hub - 5-7/8" Sqr Ring & Strainer	BI	1	10	\$85.04
<b>843-3ANR</b>	3" ABS Hub - 5-1/2" Rnd Ring & Strainer	BI	1	1	\$63.33
843-3PNQ	3" PVC Hub - 5-7/8" Sqr Ring & Strainer	BI	1	10	\$85.04
843-3PNR	3" PVC Hub - 5-1/2" Rnd Ring & Strainer	BI	1	10	\$63.33
<b>843-4ANQ</b>	4" ABS Hub - 7" Sqr Ring & Strainer	BI	1	1	\$114.37
<b>843-4ANR</b>	4" ABS Hub - 6-1/2" Rnd Ring & Strainer	BI	1	4	\$78.17
843-4PNQ	4" PVC Hub - 7" Sqr Ring & Strainer	BI	1	10	\$114.37
843-4PNR	4" PVC Hub - 6-1/2" Rnd Ring & Strainer	BI	1	4	\$78.17
<b>18-GA STAINLESS STEEL STRAINER</b>					
843-2AS	2" ABS Hub - 4-1/2" Rnd Ring & Strainer	BI	1	10	\$26.21
843-2PS	2" PVC Hub - 4-1/2" Rnd Ring & Strainer	BI	1	10	\$26.21
<b>843-3AS</b>	3" ABS Hub - 5-1/2" Rnd Ring & Strainer	BI	1	1	\$28.06
843-3PS	3" PVC Hub - 5-1/2" Rnd Ring & Strainer	BI	1	10	\$28.06
<b>843-4AS</b>	4" ABS Hub - 6-1/2" Rnd Ring & Strainer	BI	1	1	\$35.94
843-4PS	4" PVC Hub - 6-1/2" Rnd Ring & Strainer	BI	1	4	\$35.94
<b>ABS STRAINER</b>					
<b>843-2AP</b>	2" ABS Hub - 4-1/2" Rnd Ring & Strainer	BI	1	1	\$25.34
843-2PP	2" PVC Hub - 4-1/2" Rnd Ring & Strainer	BI	1	1	\$25.34
843-3AP	3" ABS Hub - 5-1/2" Rnd Ring & Strainer	BI	1	10	\$27.13
843-3PP	3" PVC Hub - 5-1/2" Rnd Ring & Strainer	BI	1	10	\$27.13
<b>843-4PP</b>	4" PVC Hub - 6-1/2" Rnd Ring & Strainer	BI	1	1	\$41.98

**PVC/ABS - Sch. 40 Hub Connection**

**Options:** Add suffix to item no. Add price to list

- S** = ABS Sand Bucket: \$14.00; **U** = ABS Debris Bucket: \$14.00;
- C** = ABS Clamping Collar: \$17.00; **V** = Vandal-Resistant Strainer (1): \$12.00;
- T** = Tapped Trap Primer Connection - 1/2" FIP: \$12.00; **2** = Open-Half Strainer (1): N/C;
- W** = Stainless Steel Debris Basket: \$52.00; **F** = Round Nickel-Bronze Condensate Funnel: \$108.00;
- FA** = Round Aluminum Condensate Funnel: \$48.00; **FO** = Oval Nickel-Bronze Condensate Funnel: \$238.00;
- 6** = ABS Flat Strainer for Drain Outlet (2): \$12.00; **D** = ABS Dome Bottom Strainer (2): \$10.00;
- L** = Aluminum Dome Bottom Strainer (2): \$22.00;

1: Not available for cast iron strainers 2: Not available for 6" drains

Item Number	Item Description	Pkg Type	Min Qty	Case Qty	Price
<b>NICKEL-BRONZE RING &amp; STRAINER</b>					
860-2AN	2" ABS Hub - 9-3/4" Rnd Grate	Bl	1	1	\$343.80
860-2PN	2" PVC Hub - 9-3/4" Rnd Grate	Bl	1	1	\$343.80
860-3AN	3" ABS Hub - 9-3/4" Rnd Grate	Bl	1	1	\$343.80
860-3PN	3" PVC Hub - 9-3/4" Rnd Grate	Bl	1	4	\$343.80
860-4AN	4" ABS Hub - 9-3/4" Rnd Grate	Bl	1	1	\$343.80
860-4PN	4" PVC Hub - 9-3/4" Rnd Grate	Bl	1	4	\$343.80
860-6AN	6" ABS Hub - 9-3/4" Rnd Grate	Bl	1	1	\$463.24
860-6PN	6" PVC Hub - 9-3/4" Rnd Grate	Bl	1	1	\$463.24
<b>STAINLESS STEEL RING &amp; STRAINER</b>					
860-2AZ	2" ABS Hub - 9-3/4" Rnd Grate	Bl	1	1	\$343.80
860-2PZ	2" PVC Hub - 9-3/4" Rnd Grate	Bl	1	4	\$343.80
860-3AZ	3" ABS Hub - 9-3/4" Rnd Grate	Bl	1	1	\$343.80
860-3PZ	3" PVC Hub - 9-3/4" Rnd Grate	Bl	1	4	\$343.80
860-4AZ	4" ABS Hub - 9-3/4" Rnd Grate	Bl	1	4	\$343.80
860-4PZ	4" PVC Hub - 9-3/4" Rnd Grate	Bl	1	4	\$343.80
860-6AZ	6" ABS Hub - 9-3/4" Rnd Grate	Bl	1	1	\$463.24
860-6PZ	6" PVC Hub - 9-3/4" Rnd Grate	Bl	1	1	\$463.24
<b>ABS/PVC STRAINER</b>					
860-2A	2" ABS Hub - 9" Rnd Grate	Bl	1	1	\$83.25
860-2P	2" PVC Hub - 9" Rnd Grate	Bl	1	4	\$83.25
860-3A	3" ABS Hub - 9" Rnd Grate	Bl	1	4	\$83.25
860-3P	3" PVC Hub - 9" Rnd Grate	Bl	1	4	\$83.25
860-4A	4" ABS Hub - 9" Rnd Grate	Bl	1	1	\$83.25
860-4P	4" PVC Hub - 9" Rnd Grate	Bl	1	4	\$83.25
860-6A	6" ABS Hub - 9" Rnd Grate	Bl	1	1	\$202.66
860-6P	6" PVC Hub - 9" Rnd Grate	Bl	1	1	\$202.66
<b>CAST IRON RING &amp; STRAINER</b>					
860-2AI	2" ABS Hub - 9-7/8" Rnd Grate	Bl	1	1	\$155.13
860-2PI	2" PVC Hub - 9-7/8" Rnd Grate	Bl	1	1	\$155.13
860-3AI	3" ABS Hub - 9-7/8" Rnd Grate	Bl	1	2	\$155.13
860-3PI	3" PVC Hub - 9-7/8" Rnd Grate	Bl	1	2	\$155.13
860-4AI	4" ABS Hub - 9-7/8" Rnd Grate	Bl	1	1	\$155.13
860-4PI	4" PVC Hub - 9-7/8" Rnd Grate	Bl	1	2	\$155.13
860-6AI	6" ABS Hub - 9-7/8" Rnd Grate	Bl	1	1	\$279.98
860-6PI	6" PVC Hub - 9-7/8" Rnd Grate	Bl	1	2	\$279.98



860-3PN



860-2AZ



860-2P



860-2PI

Supply

Drainage

Support

Specialties

Appendix

Supply

Drainage

Support

Specialties

Appendix



860-GP



860-S



860-D



864-2P



864-GP

**FatMax™ Floor Drain Accessories**

Item Number	Item Description	Pkg Type	Min Qty	Case Qty	Price
<b>STRAINERS</b>					
860-GA	ABS Full Strainer w/ Lift Handle	BI	1	12	\$36.19
<b>860-GA2</b>	ABS Open-Half Strainer	BI	1	1	\$24.38
860-GI	Cast Iron Full Strainer Only	BI	1	5	\$87.22
<b>860-GN2</b>	Nickl-Brnz Open-Half Strainer Only	BI	1	1	\$147.86
860-GP	PVC Full Strainer w/ Lift Handle	BI	1	16	\$36.19
860-GP2	PVC Open-Half Strainer	BI	1	10	\$24.38
<b>860-GPJ</b>	PVC Full Cover	BI	1	16	\$43.43
<b>860-RGN</b>	Nickl-Brnz Ring And Full Strainer	BI	1	1	\$305.00
860-RGN2	Nickl-Brnz Ring And Open-Half Strainer	BI	1	1	\$305.00
860-RGS	304 Stnls Steel Ring And Full Strainer	BI	1	1	\$305.00
860-RGS2	304 Stnls Steel Ring And Open-Half Strainer	BI	1	1	\$305.00
<b>ACCESSORIES</b>					
860-6	Flat Secondary Strainer - Gray ABS	BI	1	10	\$11.58
860-C	Clamping Collar w/ Screws - Gray ABS	BI	1	10	\$14.85
<b>860-CI</b>	Cast Iron Clamping Collar w/ Stainless Steel Screws	BI	1	10	\$26.93
860-D	Dome Bottom Strainer - Gray ABS	BI	1	80	\$9.42
860-S	Sand Bucket For Drain Sump Area - Gray ABS	BI	1	20	\$14.10
860-U	Debris Bucket For Drain Sump Area - Gray ABS	BI	1	20	\$14.10
860-UM	Stainless Steel Debris Basket	BI	1	5	\$53.08

**LittleMax™ General Purpose Floor Drain**

**Options:** Add suffix to item no. Add price to list

**V** = Vandal-Resistant Strainer: \$12.00; **T** = Tapped Trap Primer Connection - 1/2" FIP: \$8.00;

**S** = Sand Bucket: \$12.00; **U** = Stainless Steel Debris Basket for Sump Area: \$41.00;

**2** = Open-Half Strainer: \$20.00; **3** = Open-Quarter Strainer: \$20.00;

**X** = Less Strainer: N/C;

Item Number	Item Description	Pkg Type	Min Qty	Case Qty	Price
<b>DRAINS</b>					
864-2A	2" Hub - 6-5/8" Rnd ABS Grate	BI	1	3	\$55.15
864-2P	2" Hub - 6-5/8" Rnd ABS Grate	BI	1	3	\$55.15
864-3A	3" Hub - 6-5/8" Rnd ABS Grate	BI	1	3	\$55.15
864-3P	3" Hub - 6-5/8" Rnd ABS Grate	BI	1	3	\$55.15
<b>864-4A</b>	4" Hub - 6-5/8" Rnd ABS Grate	BI	1	3	\$55.15
864-4P	4" Hub - 6-5/8" Rnd ABS Grate	BI	1	3	\$55.15
<b>ACCESSORIES</b>					
<b>864-GP</b>	Strainer w/ Lift Handle, Loose Set, Gray ABS	BI	1	1	\$19.99
<b>864-GP2</b>	Open-Half Strainer, Loose Set, Gray ABS	BI	1	1	\$39.99
864-S	PVC Sand Bucket (Fits Inside Sump Area)	BI	1	10	\$12.41
864-UM	Stainless Steel Mesh Debris Basket	BI	1	10	\$41.36

**PVC/ABS - Sch. 40 Hub Connection**

**6-1/2" Tops**

Options: Add suffix to item no. Add price to list

V = Vandal-Resistant Strainer: \$6.50; H = Hinged Strainer: \$16.00;

E = Extended Ring: \$78.00; B = Complies with Buy American Act: \$62.00;



833-3PF

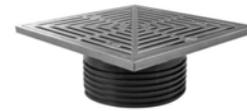

832-4HNQ

Item Number	Item Description	Pkg Type	Min Qty	Case Qty	Price
<b>ROUGH-IN FIXTURE</b>					
833-2AF	2" ABS Hub	Bl	1	10	\$44.93
833-2PF	2" PVC Hub	Bl	1	10	\$44.93
833-3AF	3" ABS Hub	Bl	1	1	\$44.93
833-3PF	3" PVC Hub	Bl	1	10	\$44.93
833-4AF	4" ABS Hub	Bl	1	10	\$44.93
833-4PF	4" PVC Hub	Bl	1	10	\$44.93
<b>FINISH FIXTURE</b>					
832-4HHD	6-1/2" Hub Drain Finish Fixture	Bl	1	10	\$18.91
832-4HNQ	7" Sqr Nikl-Brnz Ring & Strainer	Bl	1	10	\$96.41
832-4HNR	6-1/2" Rnd Nikl-Brnz Ring & Strainer	Bl	1	10	\$64.92
832-4HPR	6-1/2" Rnd Gray ABS Ring & Strainer	Bl	1	10	\$34.63
832-4HSQ	7" Sqr Stnls Steel Ring & Strainer	Bl	1	1	\$96.41
832-4HSR	6-1/2" Rnd Stnls Steel Ring & Strainer	Bl	1	10	\$64.92
<b>COMPLETE ASSEMBLY</b>					
<b>833-2ANQ</b>	2" ABS Hub - 7" Sqr Nikl-Brnz Ring & Strainer	Bl	1	1	\$141.34
833-2ANR	2" ABS Hub - 6-1/2" Rnd Nikl-Brnz Ring & Strainer	Bl	1	1	\$109.85
<b>833-2ASQ</b>	2" ABS Hub - 7" Sqr Stnls Steel Ring & Strainer	Bl	1	1	\$141.34
833-2ASR	2" ABS Hub - 6-1/2" Rnd Stnls Steel Ring & Strainer	Bl	1	1	\$109.85
833-2PNQ	2" PVC Hub - 7" Sqr Nikl-Brnz Ring & Strainer	Bl	1	1	\$141.34
833-2PNR	2" PVC Hub - 6-1/2" Rnd Nikl-Brnz Ring & Strainer	Bl	1	1	\$109.85
<b>833-2PSQ</b>	2" PVC Hub - 7" Sqr Stnls Steel Ring & Strainer	Bl	1	1	\$141.34
<b>833-2PSR</b>	2" PVC Hub - 6-1/2" Rnd Stnls Steel Ring & Strainer	Bl	1	1	\$109.85
<b>833-3ANQ</b>	3" ABS Hub - 7" Sqr Nikl-Brnz Ring & Strainer	Bl	1	1	\$141.34
833-3ANR	3" ABS Hub - 6-1/2" Rnd Nikl-Brnz Ring & Strainer	Bl	1	1	\$109.85
<b>833-3ASQ</b>	3" ABS Hub - 7" Sqr Stnls Steel Ring & Strainer	Bl	1	1	\$141.34
<b>833-3ASR</b>	3" ABS Hub - 6-1/2" Rnd Stnls Steel Ring & Strainer	Bl	1	1	\$109.85
833-3PNQ	3" PVC Hub - 7" Sqr Nikl-Brnz Ring & Strainer	Bl	1	1	\$141.34
833-3PNR	3" PVC Hub - 6-1/2" Rnd Nikl-Brnz Ring & Strainer	Bl	1	1	\$109.85
<b>833-3PSQ</b>	3" PVC Hub - 7" Sqr Stnls Steel Ring & Strainer	Bl	1	1	\$141.34
<b>833-3PSR</b>	3" PVC Hub - 6-1/2" Rnd Stnls Steel Ring & Strainer	Bl	1	1	\$109.85
<b>833-4ANQ</b>	4" ABS Hub - 7" Sqr Nikl-Brnz Ring & Strainer	Bl	1	1	\$141.34
833-4ANR	4" ABS Hub - 6-1/2" Rnd Nikl-Brnz Ring & Strainer	Bl	1	1	\$109.85
<b>833-4ASQ</b>	4" ABS Hub - 7" Sqr Stnls Steel Ring & Strainer	Bl	1	1	\$141.34
<b>833-4ASR</b>	4" ABS Hub - 6-1/2" Rnd Stnls Steel Ring & Strainer	Bl	1	1	\$109.85
833-4PNQ	4" PVC Hub - 7" Sqr Nikl-Brnz Ring & Strainer	Bl	1	1	\$141.34
833-4PNR	4" PVC Hub - 6-1/2" Rnd Nikl-Brnz Ring & Strainer	Bl	1	1	\$109.85

Supply

Drainage

Support

Specialties

Appendix

Supply

Drainage

Support

Specialties

Appendix



833-2PSR



832-P



833-25PF



832-3HNQ

**PVC/ABS - Sch. 40 Hub Connection (Cont)**

**6-1/2" Tops**

Item Number	Item Description	Pkg Type	Min Qty	Case Qty	Price
<b>COMPLETE ASSEMBLY</b>					
833-4PSQ	4" PVC Hub - 7" Sqr Stnls Steel Ring & Strainer	BI	1	1	\$141.34
833-4PSR	4" PVC Hub - 6-1/2" Rnd Stnls Steel Ring & Strainer	BI	1	1	\$109.85
<b>ACCESSORIES</b>					
832-EX4	Ductile Iron Extension Adapter - 2" Min - 4" Max	BI	1	1	\$34.14
832-P	Coring Plug Wrench	BI	1	1	\$24.65
832-S4	Two Adjustment Shims, Two 3/4" Screws	BI	10	10	\$6.10
832-UM	4-1/4" Stainless Steel Debris Basket	BI	1	15	\$21.43
832-W	Flexible Red Locating Bristles w/ Screw	BI	10	10	\$7.26
835-2	Trapshield™ For 2" Drain Outlet	BI	1	50	\$56.31
835-3	Trapshield™ For 3" Drain Outlet	BI	1	25	\$63.36
835-4	Trapshield™ For 4" Drain Outlet	BI	1	20	\$74.98
863-FA	Round Aluminum Condensate Funnel w/ Screws	BI	1	12	\$49.15
863-FN	Round Nikl-Brnz Condensate Funnel w/ Screws	BI	1	12	\$109.99
863-FNO	Oval Nikl-Brnz Condensate Funnel w/ Screws	BI	1	12	\$243.96

**PVC/ABS - Sch. 40 Hub Connection**

**5-1/2" Tops**

· Cast iron base adapter with ABS clamping collar, coring sleeve, and head adapter.

**Options:** Add suffix to item no. Add price to list

V = Vandal-Resistant Strainer: \$6.50; B = Complies with Buy American Act (1): \$62.00;

E = Extended Ring (1): \$78.00;

1: For round nickel bronze ring/strainer only

Item Number	Item Description	Pkg Type	Min Qty	Case Qty	Price
<b>ROUGH-IN FIXTURE</b>					
833-25AF	2" ABS Hub	BI	1	1	\$40.71
833-25PF	2" PVC Hub	BI	1	1	\$40.71
833-35AF	3" ABS Hub	BI	1	1	\$40.71
833-35PF	3" PVC Hub	BI	1	1	\$40.71
<b>FINISH FIXTURE</b>					
832-3HHD	5-1/2" Hub Drain Finish Fixture	BI	1	10	\$15.64
832-3HNQ	5-7/8" Sqr Nikl-Brnz Ring & Strainer	BI	1	10	\$68.00
832-3HNR	5-1/2" Rnd Nikl-Brnz Ring & Strainer	BI	1	10	\$48.00
832-3HS	5-1/2" Rnd 18-Ga Stnls Steel Strainer	B	1	20	\$19.80
832-3HSQ	5-7/8" Sqr Stnls Steel Ring & Strainer	BI	1	10	\$68.00
832-3HSR	5-1/2" Rnd Stnls Steel Ring & Strainer	BI	1	10	\$48.00



**PVC/ABS - Sch. 40 Hub Connection (Cont)**

**5-1/2" Tops**

Item Number	Item Description	Pkg Type	Min Qty	Case Qty	Price
<b>COMPLETE ASSEMBLY</b>					
833-25ANQ	2" ABS Hub - 5-7/8" Sqr Nikl-Brnz Ring & Strainer	BI	1	1	\$106.27
833-25ANR	2" ABS Hub - 5-1/2" Rnd Nikl-Brnz Ring & Strainer	BI	1	1	\$87.35
833-25ASQ	2" ABS Hub - 5-7/8" Sqr Stnls Steel Ring & Strainer	BI	1	1	\$106.27
833-25ASR	2" ABS Hub - 5-1/2" Rnd Stnls Steel Ring & Strainer	BI	1	1	\$87.35
833-25PNQ	2" PVC Hub - 5-7/8" Sqr Nikl-Brnz Ring & Strainer	BI	1	1	\$106.27
833-25PNR	2" PVC Hub - 5-1/2" Rnd Nikl-Brnz Ring & Strainer	BI	1	1	\$87.35
833-25PSQ	2" PVC Hub - 5-7/8" Sqr Stnls Steel Ring & Strainer	BI	1	1	\$106.27
833-25PSR	2" PVC Hub - 5-1/2" Rnd Stnls Steel Ring & Strainer	BI	1	1	\$87.35
833-35ANQ	3" ABS Hub - 5-7/8" Sqr Nikl-Brnz Ring & Strainer	BI	1	1	\$106.27
833-35ANR	3" ABS Hub - 5-1/2" Rnd Nikl-Brnz Ring & Strainer	BI	1	1	\$87.35
833-35ASQ	3" ABS Hub - 5-7/8" Sqr Stnls Steel Ring & Strainer	BI	1	1	\$106.27
833-35ASR	3" ABS Hub - 5-1/2" Rnd Stnls Steel Ring & Strainer	BI	1	1	\$87.35
833-35PNQ	3" PVC Hub - 5-7/8" Sqr Nikl-Brnz Ring & Strainer	BI	1	1	\$106.27
833-35PNR	3" PVC Hub - 5-1/2" Rnd Nikl-Brnz Ring & Strainer	BI	1	1	\$87.35
833-35PSQ	3" PVC Hub - 5-7/8" Sqr Stnls Steel Ring & Strainer	BI	1	1	\$106.27
833-35PSR	3" PVC Hub - 5-1/2" Rnd Stnls Steel Ring & Strainer	BI	1	1	\$87.35
<b>ACCESSORIES</b>					
832-EPS3	Extended ABS Coring Sleeve & Plug	BI	1	10	\$15.82
832-EX3	Ductile Iron Extension Adapter - 2" Min - 3-3/8" Max	BI	1	1	\$34.14
832-P	Coring Plug Wrench	BI	1	1	\$24.65
832-S3	Two Adjustment Shims, Two 3/4" Screws	BI	10	10	\$6.10
832-W	Flexible Red Locating Bristles w/ Screw	BI	10	10	\$7.26
835-2	Trapshield™ For 2" Drain Outlet	BI	1	50	\$56.31
835-3	Trapshield™ For 3" Drain Outlet	BI	1	25	\$63.36
863-FA	Round Aluminum Condensate Funnel w/ Screws	BI	1	12	\$49.15
863-FN	Round Nikl-Brnz Condensate Funnel w/ Screws	BI	1	12	\$109.99
863-FNO	Oval Nikl-Brnz Condensate Funnel w/ Screws	BI	1	12	\$243.96



833-35ANR



832-EPS3

Supply

Drainage

Support

Specialties

Appendix

Supply

Drainage

Support

Specialties

Appendix



833-22F



832-4HNQ



833-22NR



832-4HHD

## ABS on Iron - No-Hub Connection

### 6-1/2" Tops

· Cast iron base adapter with ABS clamping collar, coring sleeve, and head adapter.

**Options:** Add suffix to item no. Add price to list

**V** = Vandal-Resistant Strainer: \$6.50; **H** = Hinged Strainer: \$16.00;

**E** = Extended Ring (1): \$78.00; **B** = Complies with Buy American Act (1): \$62.00;

1: For round nickel-bronze ring/strainer only

Item Number	Item Description	Pkg Type	Min Qty	Case Qty	Price
<b>ROUGH-IN FIXTURE</b>					
833-22F	2" No-Hub	BI	1	1	\$66.18
833-23F	3" No-Hub	BI	1	1	\$66.18
833-24F	4" No-Hub	BI	1	1	\$66.18
<b>FINISH FIXTURE</b>					
832-4HHD	6-1/2" Hub Drain Finish Fixture	BI	1	10	\$18.91
832-4HNQ	7" Sqr Nikl-Brnz Ring & Strainer	BI	1	10	\$96.41
832-4HNR	6-1/2" Rnd Nikl-Brnz Ring & Strainer	BI	1	10	\$64.92
832-4HPR	6-1/2" Rnd Gray ABS Ring & Strainer	BI	1	10	\$34.63
832-4HSQ	7" Sqr Stnls Steel Ring & Strainer	BI	1	1	\$96.41
832-4HSR	6-1/2" Rnd Stnls Steel Ring & Strainer	BI	1	10	\$64.92
<b>COMPLETE ASSEMBLY</b>					
<b>833-22NQ</b>	2" No-Hub - 7" Sqr Nikl-Brnz Ring & Strainer	BI	1	1	\$162.59
833-22NR	2" No-Hub - 6-1/2" Rnd Nikl-Brnz Ring & Strainer	BI	1	1	\$131.10
<b>833-22SQ</b>	2" No-Hub - 7" Sqr Stnls Steel Ring & Strainer	BI	1	1	\$162.59
833-22SR	2" No-Hub - 6-1/2" Rnd Stnls Steel Ring & Strainer	BI	1	1	\$131.10
<b>833-23NQ</b>	3" No-Hub - 7" Sqr Nikl-Brnz Ring & Strainer	BI	1	1	\$162.59
833-23NR	3" No-Hub - 6-1/2" Rnd Nikl-Brnz Ring & Strainer	BI	1	1	\$131.10
<b>833-23SQ</b>	3" No-Hub - 7" Sqr Stnls Steel Ring & Strainer	BI	1	1	\$162.59
833-23SR	3" No-Hub - 6-1/2" Rnd Stnls Steel Ring & Strainer	BI	1	1	\$131.10
<b>833-24NQ</b>	4" No-Hub - 7" Sqr Nikl-Brnz Ring & Strainer	BI	1	1	\$162.59
833-24NR	4" No-Hub - 6-1/2" Rnd Nikl-Brnz Ring & Strainer	BI	1	1	\$131.10
<b>833-24SQ</b>	4" No-Hub - 7" Sqr Stnls Steel Ring & Strainer	BI	1	1	\$162.59
<b>833-24SR</b>	4" No-Hub - 6-1/2" Rnd Stnls Steel Ring & Strainer	BI	1	1	\$131.10
<b>ACCESSORIES</b>					
832-EX4	Ductile Iron Extension Adapter - 2" Min - 4" Max	BI	1	1	\$34.14
832-P	Coring Plug Wrench	BI	1	1	\$24.65
832-S4	Two Adjustment Shims, Two 3/4" Screws	BI	10	10	\$6.10
832-UM	4-1/4" Stainless Steel Debris Basket	BI	1	15	\$21.43
832-W	Flexible Red Locating Bristles w/ Screw	BI	10	10	\$7.26
835-2	Trapshield™ For 2" Drain Outlet	BI	1	50	\$56.31
835-3	Trapshield™ For 3" Drain Outlet	BI	1	25	\$63.36
835-4	Trapshield™ For 4" Drain Outlet	BI	1	20	\$74.98
863-FA	Round Aluminum Condensate Funnel w/ Screws	BI	1	12	\$49.15
863-FN	Round Nikl-Brnz Condensate Funnel w/ Screws	BI	1	12	\$109.99
863-FNO	Oval Nikl-Brnz Condensate Funnel w/ Screws	BI	1	12	\$243.96

**ABS on Iron - No-Hub Connection**

**5-1/2" Tops**

**Options:** Add suffix to item no. Add price to list

**V** = Vandal-Resistant Strainer: \$6.50; **B** = Complies with Buy American Act (1): \$62.00;

**E** = Extended Ring (2): \$78.00;

1: For round nickel-bronzed ring/strainer only 2: For round nickel-bronze ring/strainer only

Item Number	Item Description	Pkg Type	Min Qty	Case Qty	Price
<b>ROUGH-IN FIXTURE</b>					
833-225F	2" No-Hub	BI	1	1	\$62.03
833-235F	3" No-Hub	BI	1	1	\$62.03
<b>FINISH FIXTURE</b>					
832-3HHD	5-1/2" Hub Drain Finish Fixture	BI	1	10	\$15.64
832-3HNQ	5-7/8" Sqr Nikl-Brnz Ring & Strainer	BI	1	10	\$68.00
832-3HNR	5-1/2" Rnd Nikl-Brnz Ring & Strainer	BI	1	10	\$48.00
832-3HS	5-1/2" Rnd 18-Ga Stnls Steel Strainer	B	1	20	\$19.80
832-3HSQ	5-7/8" Sqr Stnls Steel Ring & Strainer	BI	1	10	\$68.00
832-3HSR	5-1/2" Rnd Stnls Steel Ring & Strainer	BI	1	10	\$48.00
<b>COMPLETE ASSEMBLY</b>					
833-225NQ	2" No-Hub - 5-7/8" Sqr Nikl-Brnz Ring & Strainer	BI	1	1	\$127.59
833-225NR	2" No-Hub - 5-1/2" Rnd Nikl-Brnz Ring & Strainer	BI	1	1	\$108.67
833-225SQ	2" No-Hub - 5-7/8" Sqr Stnls Steel Ring & Strainer	BI	1	1	\$127.59
833-225SR	2" No-Hub - 5-1/2" Rnd Stnls Steel Ring & Strainer	BI	1	1	\$108.67
833-235NQ	3" No-Hub - 5-7/8" Sqr Nikl-Brnz Ring & Strainer	BI	1	1	\$127.59
833-235NR	3" No-Hub - 5-1/2" Rnd Nikl-Brnz Ring & Strainer	BI	1	1	\$108.67
833-235SQ	3" No-Hub - 5-7/8" Sqr Stnls Steel Ring & Strainer	BI	1	1	\$127.59
833-235SR	3" No-Hub - 5-1/2" Rnd Stnls Steel Ring & Strainer	BI	1	1	\$108.67
<b>ACCESSORIES</b>					
832-EX3	Ductile Iron Extension Adapter - 2" Min - 3-3/8" Max	BI	1	1	\$34.14
832-P	Coring Plug Wrench	BI	1	1	\$24.65
832-S3	Two Adjustment Shims, Two 3/4" Screws	BI	10	10	\$6.10
832-W	Flexible Red Locating Bristles w/ Screw	BI	10	10	\$7.26
835-2	Trapshield™ For 2" Drain Outlet	BI	1	50	\$56.31
835-3	Trapshield™ For 3" Drain Outlet	BI	1	25	\$63.36
863-FA	Round Aluminum Condensate Funnel w/ Screws	BI	1	12	\$49.15
863-FN	Round Nikl-Brnz Condensate Funnel w/ Screws	BI	1	12	\$109.99
863-FNO	Oval Nikl-Brnz Condensate Funnel w/ Screws	BI	1	12	\$243.96



833-235F



832-3HSR



833-235SR



832-S3

Supply

Drainage

Support

Specialties

Appendix

Supply

Drainage

Support

Specialties

Appendix



833-62F



832-4HNQ



833-62NR

## ABS on Iron - Push-Joint Connection

### 6-1/2" Tops

· Cast iron base adapter with ABS clamping collar, coring sleeve, and head adapter.

**Options:** Add suffix to item no. Add price to list

**V** = Vandal-Resistant Strainer: \$6.50; **H** = Hinged Strainer: \$16.00;

**E** = Extended Ring (1): \$78.00; **B** = Complies with Buy American Act (1): \$62.00;

**P** = Push-Joint Gasket to Fit Sch. 40 ABS/PVC Pipe (2): \$5.00;

1: For round nickel-bronze ring/strainer only 2: For 3" & 4" drains only

Item Number	Item Description	Pkg Type	Min Qty	Case Qty	Price
<b>ROUGH-IN FIXTURE</b>					
833-62F	2" PJ Conn.	BI	1	1	\$66.18
833-63F	3" PJ Conn.	BI	1	1	\$66.18
833-64F	4" PJ Conn.	BI	1	4	\$66.18
<b>FINISH FIXTURE</b>					
832-4HHD	6-1/2" Hub Drain Finish Fixture	BI	1	10	\$18.91
832-4HNQ	7" Sqr Nikl-Brnz Ring & Strainer	BI	1	10	\$96.41
832-4HNR	6-1/2" Rnd Nikl-Brnz Ring & Strainer	BI	1	10	\$64.92
832-4HPR	6-1/2" Rnd Gray ABS Ring & Strainer	BI	1	10	\$34.63
832-4HSQ	7" Sqr Stnls Steel Ring & Strainer	BI	1	1	\$96.41
832-4HSR	6-1/2" Rnd Stnls Steel Ring & Strainer	BI	1	10	\$64.92
<b>COMPLETE ASSEMBLY</b>					
833-62NQ	2" PJ Conn. - 7" Sqr Nikl-Brnz Ring & Strainer	BI	1	1	\$162.59
833-62NR	2" PJ Conn. - 6-1/2" Rnd Nikl-Brnz Ring & Strainer	BI	1	1	\$131.10
833-62SQ	2" PJ Conn. - 7" Sqr Stnls Steel Ring & Strainer	BI	1	1	\$162.59
833-62SR	2" PJ Conn. - 6-1/2" Rnd Stnls Steel Ring & Strainer	BI	1	1	\$131.10
833-63NQ	3" PJ Conn. - 7" Sqr Nikl-Brnz Ring & Strainer	BI	1	1	\$162.59
833-63NR	3" PJ Conn. - 6-1/2" Rnd Nikl-Brnz Ring & Strainer	BI	1	1	\$131.10
833-63SQ	3" PJ Conn. - 7" Sqr Stnls Steel Ring & Strainer	BI	1	1	\$162.59
833-63SR	3" PJ Conn. - 6-1/2" Rnd Stnls Steel Ring & Strainer	BI	1	1	\$131.10
833-64NQ	4" PJ Conn. - 7" Sqr Nikl-Brnz Ring & Strainer	BI	1	1	\$162.59
833-64NR	4" PJ Conn. - 6-1/2" Rnd Nikl-Brnz Ring & Strainer	BI	1	1	\$131.10
833-64SQ	4" PJ Conn. - 7" Sqr Stnls Steel Ring & Strainer	BI	1	1	\$162.59
833-64SR	4" PJ Conn. - 6-1/2" Rnd Stnls Steel Ring & Strainer	BI	1	1	\$131.10

**ABS on Iron - Push-Joint Connection (Cont)**

**6-1/2" Tops**

Item Number	Item Description	Pkg Type	Min Qty	Case Qty	Price
<b>ACCESSORIES</b>					
832-EX4	Ductile Iron Extension Adapter - 2" Min - 4" Max	BI	1	1	\$34.14
832-P	Coring Plug Wrench	BI	1	1	\$24.65
832-S4	Two Adjustment Shims, Two 3/4" Screws	BI	10	10	\$6.10
832-UM	4-1/4" Stainless Steel Debris Basket	BI	1	15	\$21.43
832-W	Flexible Red Locating Bristles w/ Screw	BI	10	10	\$7.26
835-2	Trapshield™ For 2" Drain Outlet	BI	1	50	\$56.31
835-3	Trapshield™ For 3" Drain Outlet	BI	1	25	\$63.36
835-4	Trapshield™ For 4" Drain Outlet	BI	1	20	\$74.98
<b>858-PG3</b>	Push-Joint Gasket For 3" Sch. 40 Pipe	BI	1	20	\$16.17
858-PG4	Push-Joint Gasket For 4" Sch. 40 Pipe	BI	1	20	\$15.48
863-FA	Round Aluminum Condensate Funnel w/ Screws	BI	1	12	\$49.15
863-FN	Round Nikl-Brnz Condensate Funnel w/ Screws	BI	1	12	\$109.99
863-FNO	Oval Nikl-Brnz Condensate Funnel w/ Screws	BI	1	12	\$243.96



832-4HHD

**ABS on Iron - Push-Joint Connection**

**5-1/2" Tops**

· Cast iron base adapter with ABS clamping collar, coring sleeve, and head adapter.

**Options:** Add suffix to item no. Add price to list

**V** = Vandal-Resistant Strainer: \$6.50; **B** = Complies with Buy American Act (1): \$62.00;

**E** = Extended Ring (1): \$78.00; **P** = Push-Joint Gasket to Fit Sch. 40 ABS/PVC Pipe (2): \$5.00;

1: For round nickel-bronze ring/strainer only 2: For 3" drains only

Item Number	Item Description	Pkg Type	Min Qty	Case Qty	Price
<b>ROUGH-IN FIXTURE</b>					
<b>833-625F</b>	2" PJ Conn.	BI	1	1	\$62.03
<b>833-635F</b>	3" PJ Conn.	BI	1	1	\$62.03
<b>FINISH FIXTURE</b>					
832-3HHD	5-1/2" Hub Drain Finish Fixture	BI	1	10	\$15.64
832-3HNP	5-7/8" Sqr Nikl-Brnz Ring & Strainer	BI	1	10	\$68.00
832-3HNR	5-1/2" Rnd Nikl-Brnz Ring & Strainer	BI	1	10	\$48.00
832-3HS	5-1/2" Rnd 18-Ga Stnls Steel Strainer	B	1	20	\$19.80
<b>832-3HSQ</b>	5-7/8" Sqr Stnls Steel Ring & Strainer	BI	1	10	\$68.00
832-3HSR	5-1/2" Rnd Stnls Steel Ring & Strainer	BI	1	10	\$48.00



833-625F



832-3HNR

Supply

Drainage

Support

Specialties

Appendix

Supply

Drainage

Support

Specialties

Appendix



833-625NQ



832-W

**ABS on Iron - Push-Joint Connection (Cont)**  
**5-1/2" Tops**

Item Number	Item Description	Pkg Type	Min Qty	Case Qty	Price
<b>COMPLETE ASSEMBLY</b>					
833-625NQ	2" PJ Conn. - 5-7/8" Sqr Nikl-Brnz Ring & Strainer	BI	1	1	\$127.59
833-625NR	2" PJ Conn. - 5-1/2" Rnd Nikl-Brnz Ring & Strainer	BI	1	1	\$108.67
833-625SQ	2" PJ Conn. - 5-7/8" Sqr Stnls Steel Ring & Strainer	BI	1	1	\$127.59
833-625SR	2" PJ Conn. - 5-1/2" Rnd Stnls Steel Ring & Strainer	BI	1	1	\$108.67
833-635NQ	3" PJ Conn. - 5-7/8" Sqr Nikl-Brnz Ring & Strainer	BI	1	1	\$127.59
833-635NR	3" PJ Conn. - 5-1/2" Rnd Nikl-Brnz Ring & Strainer	BI	1	1	\$108.67
833-635SQ	3" PJ Conn. - 5-7/8" Sqr Stnls Steel Ring & Strainer	BI	1	1	\$127.59
833-635SR	3" PJ Conn. - 5-1/2" Rnd Stnls Steel Ring & Strainer	BI	1	1	\$108.67
<b>ACCESSORIES</b>					
832-EX3	Ductile Iron Extension Adapter - 2" Min - 3-3/8" Max	BI	1	1	\$34.14
832-P	Coring Plug Wrench	BI	1	1	\$24.65
832-S3	Two Adjustment Shims, Two 3/4" Screws	BI	10	10	\$6.10
832-W	Flexible Red Locating Bristles w/ Screw	BI	10	10	\$7.26
835-2	Trapshield™ For 2" Drain Outlet	BI	1	50	\$56.31
835-3	Trapshield™ For 3" Drain Outlet	BI	1	25	\$63.36
<b>858-PG3</b>	Push-Joint Gasket For 3" Sch. 40 Pipe	BI	1	20	\$16.17
863-FA	Round Aluminum Condensate Funnel w/ Screws	BI	1	12	\$49.15
863-FN	Round Nikl-Brnz Condensate Funnel w/ Screws	BI	1	12	\$109.99
863-FNO	Oval Nikl-Brnz Condensate Funnel w/ Screws	BI	1	12	\$243.96

**PVC/ABS - Sch. 40 Hub Connection**

**6-1/2" Tops**

**Options:** Add suffix to item no. Add price to list

**V** = Vandal-Resistant Strainer: \$6.50; **H** = Hinged Strainer: \$16.00;

**Y** = Ductile Iron Head Adapter (1): \$26.00; **D** = Ductile Iron Clamping Collar (1): \$26.00;

**T** = Tapped Trap Primer Connection - 1/2" FIP: \$12.00; **E** = Extended Ring (2): \$78.00;

**B** = Complies with Buy American Act (2): \$62.00; **M** = Medium-Duty Strainer (3,000 lbs. safe-load) (3): \$39.00;

1: In lieu of ABS (standard) 2: For round nickel-bronze ring/strainer only 3: For round 304 SS ring/strainer only



863-42NR



863-42NQ

Item Number	Item Description	Pkg Type	Min Qty	Case Qty	Price
<b>NICKEL-BRONZE RING &amp; STRAINER</b>					
863-32NQ	2" ABS Hub - 7" Sqr Ring & Strainer	Bl	1	2	\$142.95
863-32NR	2" ABS Hub - 6-1/2" Rnd Ring & Strainer	Bl	1	6	\$106.95
863-33NQ	3" ABS Hub - 7" Sqr Ring & Strainer	Bl	1	1	\$142.95
863-33NR	3" ABS Hub - 6-1/2" Rnd Ring & Strainer	Bl	1	6	\$106.95
863-34NQ	4" ABS Hub - 7" Sqr Ring & Strainer	Bl	1	2	\$142.95
863-34NR	4" ABS Hub - 6-1/2" Rnd Ring & Strainer	Bl	1	6	\$106.95
863-42NQ	2" PVC Hub - 7" Sqr Ring & Strainer	Bl	1	2	\$142.95
863-42NR	2" PVC Hub - 6-1/2" Rnd Ring & Strainer	Bl	1	6	\$106.95
863-43NQ	3" PVC Hub - 7" Sqr Ring & Strainer	Bl	1	2	\$142.95
863-43NR	3" PVC Hub - 6-1/2" Rnd Ring & Strainer	Bl	1	6	\$106.95
863-44NQ	4" PVC Hub - 7" Sqr Ring & Strainer	Bl	1	2	\$142.95
863-44NR	4" PVC Hub - 6-1/2" Rnd Ring & Strainer	Bl	1	6	\$106.95
<b>STAINLESS STEEL RING &amp; STRAINER</b>					
863-32SQ	2" ABS Hub - 7" Sqr Ring & Strainer	Bl	1	2	\$142.95
863-32SR	2" ABS Hub - 6-1/2" Rnd Ring & Strainer	Bl	1	6	\$106.95
863-33SQ	3" ABS Hub - 7" Sqr Ring & Strainer	Bl	1	2	\$142.95
863-33SR	3" ABS Hub - 6-1/2" Rnd Ring & Strainer	Bl	1	6	\$106.95
863-34SQ	4" ABS Hub - 7" Sqr Ring & Strainer	Bl	1	2	\$142.95
863-34SR	4" ABS Hub - 6-1/2" Rnd Ring & Strainer	Bl	1	6	\$106.95
863-42SQ	2" PVC Hub - 7" Sqr Ring & Strainer	Bl	1	1	\$142.95
863-42SR	2" PVC Hub - 6-1/2" Rnd Ring & Strainer	Bl	1	6	\$106.95
863-43SQ	3" PVC Hub - 7" Sqr Ring & Strainer	Bl	1	1	\$142.95
863-43SR	3" PVC Hub - 6-1/2" Rnd Ring & Strainer	Bl	1	1	\$106.95
863-44SQ	4" PVC Hub - 7" Sqr Ring & Strainer	Bl	1	1	\$142.95
863-44SR	4" PVC Hub - 6-1/2" Rnd Ring & Strainer	Bl	1	1	\$106.95
<b>ACCESSORIES</b>					
835-2	Trapshield™ For 2" Drain Outlet	Bl	1	50	\$56.31
835-3	Trapshield™ For 3" Drain Outlet	Bl	1	25	\$63.36
835-35	Trapshield™ For 3-1/2" Drain Head	Bl	1	25	\$63.36
835-4	Trapshield™ For 4" Drain Outlet	Bl	1	20	\$74.98
842-UM	4-5/8" Stainless Steel Debris Basket	Bl	1	10	\$21.67
863-FA	Round Aluminum Condensate Funnel w/ Screws	Bl	1	12	\$49.15
863-FN	Round Nikl-Brnz Condensate Funnel w/ Screws	Bl	1	12	\$109.99
863-FNO	Oval Nikl-Brnz Condensate Funnel w/ Screws	Bl	1	12	\$243.96

Supply

Drainage

Support

Specialties

Appendix



863-435NR



863-425SQ

## PVC/ABS - Sch. 40 Hub Connection

### 5-1/2" Tops

**Options:** Add suffix to item no. Add price to list

**V** = Vandal-Resistant Strainer: \$6.50; **Y** = Ductile Iron Head Adapter (1): \$26.00;

**D** = Ductile Iron Clamping Collar (1): \$26.00; **T** = Tapped Trap Primer Connection - 1/2" FIP: \$12.00;

**E** = Extended Ring (2): \$78.00; **B** = Complies with Buy American Act (2): \$62.00;

1: In lieu of ABS (standard) 2: For round nickel-bronze ring/strainer only

Item Number	Item Description	Pkg Type	Min Qty	Case Qty	Price
<b>NICKEL-BRONZE RING &amp; STRAINER</b>					
863-325NQ	2" ABS Hub - 5-7/8" Sqr Ring & Strainer	BI	1	2	\$111.38
863-325NR	2" ABS Hub - 5-1/2" Rnd Ring & Strainer	BI	1	6	\$90.38
<b>863-335NQ</b>	3" ABS Hub - 5-7/8" Sqr Ring & Strainer	BI	1	2	\$111.38
863-335NR	3" ABS Hub - 5-1/2" Rnd Ring & Strainer	BI	1	6	\$90.38
<b>863-345NQ</b>	4" ABS Hub - 5-7/8" Sqr Ring & Strainer	BI	1	2	\$142.95
<b>863-345NR</b>	4" ABS Hub - 5-1/2" Rnd Ring & Strainer	BI	1	6	\$106.95
863-425NQ	2" PVC Hub - 5-7/8" Sqr Ring & Strainer	BI	1	2	\$142.95
863-425NR	2" PVC Hub - 5-1/2" Rnd Ring & Strainer	BI	1	6	\$106.95
863-435NQ	3" PVC Hub - 5-7/8" Sqr Ring & Strainer	BI	1	2	\$111.38
863-435NR	3" PVC Hub - 5-1/2" Rnd Ring & Strainer	BI	1	6	\$90.38
<b>863-445NQ</b>	4" PVC Hub - 5-7/8" Sqr Ring & Strainer	BI	1	1	\$142.95
<b>863-445NR</b>	4" PVC Hub - 5-1/2" Rnd Ring & Strainer	BI	1	6	\$106.95
<b>STAINLESS STEEL RING &amp; STRAINER</b>					
<b>863-325SQ</b>	2" ABS Hub - 5-7/8" Sqr Ring & Strainer	BI	1	2	\$111.38
863-325SR	2" ABS Hub - 5-1/2" Rnd Ring & Strainer	BI	1	6	\$90.38
<b>863-335SQ</b>	3" ABS Hub - 5-7/8" Sqr Ring & Strainer	BI	1	2	\$111.38
<b>863-335SR</b>	3" ABS Hub - 5-1/2" Rnd Ring & Strainer	BI	1	6	\$90.38
<b>863-425SQ</b>	2" PVC Hub - 5-7/8" Sqr Ring & Strainer	BI	1	2	\$142.95
<b>863-425SR</b>	2" PVC Hub - 5-1/2" Rnd Ring & Strainer	BI	1	1	\$106.95
<b>863-435SQ</b>	3" PVC Hub - 5-7/8" Sqr Ring & Strainer	BI	1	2	\$111.38
863-435SR	3" PVC Hub - 5-1/2" Rnd Ring & Strainer	BI	1	6	\$90.38
<b>ACCESSORIES</b>					
822-EX3	Ductile Iron Extension Adapter	B	1	1	\$35.33
835-2	Trapshield™ For 2" Drain Outlet	BI	1	50	\$56.31
835-3	Trapshield™ For 3" Drain Outlet	BI	1	25	\$63.36
835-35	Trapshield™ For 3-1/2" Drain Head	BI	1	25	\$63.36
835-4	Trapshield™ For 4" Drain Outlet	BI	1	20	\$74.98
863-FA	Round Aluminum Condensate Funnel w/ Screws	BI	1	12	\$49.15
863-FN	Round Nikl-Brnz Condensate Funnel w/ Screws	BI	1	12	\$109.99



**ABS on Iron - No-Hub Connection**

· Cast iron base adapter with ABS clamping collar and head adapter.

**Options:** Add suffix to item no. Add price to list

**V** = Vandal-Resistant Strainer: \$6.50; **H** = Hinged Strainer: \$16.00;  
**Y** = Ductile Iron Head Adapter (1): \$26.00; **D** = Ductile Iron Clamping Collar (1): \$26.00;  
**E** = Extended Ring (2): \$78.00; **B** = Complies with Buy American Act (2): \$62.00;  
**M** = Medium-Duty Strainer (3,000 lbs. safe-load) (3): \$39.00;

1: In lieu of ABS (standard) 2: For round nickel-bronze ring/strainer only 3: For round 304 SS ring/strainer only



863-24NQ

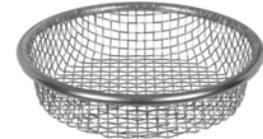

842-UM

Item Number	Item Description	Pkg Type	Min Qty	Case Qty	Price
<b>NICKEL-BRONZE RING &amp; STRAINER</b>					
863-22NQ	2" No-Hub - 7" Sqr Ring & Strainer	Bl	1	2	\$207.40
863-22NR	2" No-Hub - 6-1/2" Rnd Ring & Strainer	Bl	1	3	\$171.40
863-23NQ	3" No-Hub - 7" Sqr Ring & Strainer	Bl	1	2	\$207.40
863-23NR	3" No-Hub - 6-1/2" Rnd Ring & Strainer	Bl	1	2	\$171.40
863-24NQ	4" No-Hub - 7" Sqr Ring & Strainer	Bl	1	1	\$207.40
863-24NR	4" No-Hub - 6-1/2" Rnd Ring & Strainer	Bl	1	1	\$171.40
<b>STAINLESS STEEL RING &amp; STRAINER</b>					
863-22SQ	2" No-Hub - 7" Sqr Ring & Strainer	Bl	1	1	\$207.40
863-22SR	2" No-Hub - 6-1/2" Rnd Ring & Strainer	Bl	1	1	\$171.40
863-23SQ	3" No-Hub - 7" Sqr Ring & Strainer	Bl	1	1	\$207.40
863-23SR	3" No-Hub - 6-1/2" Rnd Ring & Strainer	Bl	1	1	\$171.40
863-24SQ	4" No-Hub - 7" Sqr Ring & Strainer	Bl	1	1	\$207.40
863-24SR	4" No-Hub - 6-1/2" Rnd Ring & Strainer	Bl	1	2	\$171.40
<b>ACCESSORIES</b>					
835-2	Trapshield™ For 2" Drain Outlet	Bl	1	50	\$56.31
835-3	Trapshield™ For 3" Drain Outlet	Bl	1	25	\$63.36
835-35	Trapshield™ For 3-1/2" Drain Head	Bl	1	25	\$63.36
835-4	Trapshield™ For 4" Drain Outlet	Bl	1	20	\$74.98
842-UM	4-5/8" Stainless Steel Debris Basket	Bl	1	10	\$21.67
863-FA	Round Aluminum Condensate Funnel w/ Screws	Bl	1	12	\$49.15
863-FN	Round Nikl-Brnz Condensate Funnel w/ Screws	Bl	1	12	\$109.99
863-FNO	Oval Nikl-Brnz Condensate Funnel w/ Screws	Bl	1	12	\$243.96

Supply

Drainage

Support

Specialties

Appendix



863-64NQ

### ABS on Iron - Push-Joint Connection

- Cast iron base adapter with ABS clamping collar and head adapter.

**Options:** Add suffix to item no. Add price to list

**V** = Vandal-Resistant Strainer: \$6.50; **H** = Hinged Strainer: \$16.00;

**Y** = Ductile Iron Head Adapter (1): \$26.00; **D** = Ductile Iron Clamping Collar (1): \$26.00;

**E** = Extended Ring (2): \$78.00; **B** = Complies with Buy American Act (2): \$62.00;

**P** = Push-Joint Gasket to fit Sch. 40 Pipe (3): \$5.00; **M** = Medium-Duty Strainer (3,000 lbs. safe-load) (4): \$39.00;

1: In lieu of ABS (standard) 2: For round nickel-bronze ring/strainer only 3: Not available for 2" drains 4: For round 304 SS ring/strainer only

Item Number	Item Description	Pkg Type	Min Qty	Case Qty	Price
<b>NICKEL-BRONZE RING &amp; STRAINER</b>					
<b>863-62NQ</b>	2" PJ Conn. - 7" Sqr Ring & Strainer	BI	1	1	\$207.40
863-62NR	2" PJ Conn. - 6-1/2" Rnd Ring & Strainer	BI	1	3	\$171.40
<b>863-63NQ</b>	3" PJ Conn. - 7" Sqr Ring & Strainer	BI	1	1	\$207.40
863-63NR	3" PJ Conn. - 6-1/2" Rnd Ring & Strainer	BI	1	2	\$171.40
<b>863-64NQ</b>	4" PJ Conn. - 7" Sqr Ring & Strainer	BI	1	1	\$207.40
863-64NR	4" PJ Conn. - 6-1/2" Rnd Ring & Strainer	BI	1	2	\$171.40
<b>STAINLESS STEEL RING &amp; STRAINER</b>					
<b>863-62SQ</b>	2" PJ Conn. - 7" Sqr Ring & Strainer	BI	1	1	\$207.40
<b>863-62SR</b>	2" PJ Conn. - 6-1/2" Rnd Ring & Strainer	BI	1	1	\$171.40
<b>863-63SQ</b>	3" PJ Conn. - 7" Sqr Ring & Strainer	BI	1	1	\$207.40
<b>863-63SR</b>	3" PJ Conn. - 6-1/2" Rnd Ring & Strainer	BI	1	1	\$171.40
<b>863-64SQ</b>	4" PJ Conn. - 7" Sqr Ring & Strainer	BI	1	1	\$207.40
<b>863-64SR</b>	4" PJ Conn. - 6-1/2" Rnd Ring & Strainer	BI	1	1	\$171.40
<b>ACCESSORIES</b>					
835-2	Trapshield™ For 2" Drain Outlet	BI	1	50	\$56.31
835-3	Trapshield™ For 3" Drain Outlet	BI	1	25	\$63.36
835-35	Trapshield™ For 3-1/2" Drain Head	BI	1	25	\$63.36
835-4	Trapshield™ For 4" Drain Outlet	BI	1	20	\$74.98
842-UM	4-5/8" Stainless Steel Debris Basket	BI	1	10	\$21.67
863-FA	Round Aluminum Condensate Funnel w/ Screws	BI	1	12	\$49.15
863-FN	Round Nikl-Brnz Condensate Funnel w/ Screws	BI	1	12	\$109.99
863-FNO	Oval Nikl-Brnz Condensate Funnel w/ Screws	BI	1	12	\$243.96

Halo™ Floor Drains

PVC/ABS - Sch. 40 Hub Connection

Options: Add suffix to item no. Add price to list

M = Clamping Collar Kit (1): \$19.50; V = Vandal-Resistant Strainer: \$6.50;

B = Complies with Buy American Act (2): \$62.00; E = Extended Ring (2): \$78.00;

1: Add 'M' after dash - all other options at end of item no. 2: For round nickel bronze ring/strainer only

Item Number	Item Description	Pkg Type	Min Qty	Case Qty	Price
<b>NICKEL-BRONZE RING &amp; STRAINER</b>					
822-2ANQ	2" ABS Hub - 5-7/8" Sqr Ring & Strainer	Bl	1	4	\$95.00
822-2ANR	2" ABS Hub - 5-1/2" Rnd Ring & Strainer	Bl	1	4	\$75.00
822-2PNQ	2" PVC Hub - 5-7/8" Sqr Ring & Strainer	Bl	1	4	\$95.00
822-2PNR	2" PVC Hub - 5-1/2" Rnd Ring & Strainer	Bl	1	4	\$75.00
822-3ANQ	3" ABS Hub - 5-7/8" Sqr Ring & Strainer	Bl	1	4	\$95.00
822-3ANR	3" ABS Hub - 5-1/2" Rnd Ring & Strainer	Bl	1	4	\$75.00
822-3PNQ	3" PVC Hub - 5-7/8" Sqr Ring & Strainer	Bl	1	4	\$95.00
822-3PNR	3" PVC Hub - 5-1/2" Rnd Ring & Strainer	Bl	1	4	\$75.00
<b>STAINLESS STEEL RING &amp; STRAINER</b>					
822-2ASQ	2" ABS Hub - 5-7/8" Sqr Ring & Strainer	Bl	1	4	\$95.00
822-2ASR	2" ABS Hub - 5-1/2" Rnd Ring & Strainer	Bl	1	4	\$75.00
822-2PSQ	2" PVC Hub - 5-7/8" Sqr Ring & Strainer	Bl	1	4	\$95.00
822-2PSR	2" PVC Hub - 5-1/2" Rnd Ring & Strainer	Bl	1	4	\$75.00
822-3ASQ	3" ABS Hub - 5-7/8" Sqr Ring & Strainer	Bl	1	4	\$95.00
822-3ASR	3" ABS Hub - 5-1/2" Rnd Ring & Strainer	Bl	1	1	\$75.00
822-3PSQ	3" PVC Hub - 5-7/8" Sqr Ring & Strainer	Bl	1	4	\$95.00
822-3PSR	3" PVC Hub - 5-1/2" Rnd Ring & Strainer	Bl	1	4	\$75.00
<b>18-GA STAINLESS STEEL STRAINER</b>					
822-2AS	2" ABS Hub - 5-3/8" Rnd Ring & Strainer	Bl	1	4	\$43.45
822-2PS	2" PVC Hub - 5-3/8" Rnd Ring & Strainer	Bl	1	4	\$43.45
822-3AS	3" ABS Hub - 5-3/8" Rnd Ring & Strainer	Bl	1	4	\$43.45
822-3PS	3" PVC Hub - 5-3/8" Rnd Ring & Strainer	Bl	1	4	\$43.45
<b>ACCESSORIES</b>					
822-CKIT	Clamping Collar Kit	Bl	1	10	\$21.79
822-EX3	Ductile Iron Extension Adapter	B	1	1	\$35.33
822-TB	Thread Bushing For Halo Head	Bl	1	10	\$20.45
835-2	Trapshield™ For 2" Drain Outlet	Bl	1	50	\$56.31
835-3	Trapshield™ For 3" Drain Outlet	Bl	1	25	\$63.36
835-35	Trapshield™ For 3-1/2" Drain Head	Bl	1	25	\$63.36
863-FA	Round Aluminum Condensate Funnel w/ Screws	Bl	1	12	\$49.15
863-FN	Round Nikl-Brnz Condensate Funnel w/ Screws	Bl	1	12	\$109.99
863-FNO	Oval Nikl-Brnz Condensate Funnel w/ Screws	Bl	1	12	\$243.96



822-3ANR



822-2PSQ

Supply

Drainage

Support

Specialties

Appendix

**FinishLine Halo™ Floor Drains**

**PVC/ABS - Sch. 40 Hub Connection**

**Options:** Add suffix to item no. Add price to list

**M** = Clamping Collar Kit (1): \$19.50; **V** = Vandal-Resistant Strainer: \$6.50;

**B** = Complies with Buy American Act (2): \$62.00; **E** = Extended Ring (2): \$78.00;

1: Add 'M' after dash - all other options at end of item no. 2: For round nickel bronze ring/strainer only



822-3PF



832-3HSQ



822-F2ANR

Item Number	Item Description	Pkg Type	Min Qty	Case Qty	Price
<b>ROUGH-IN FIXTURE</b>					
822-2AF	2" ABS Hub	BI	1	4	\$52.00
822-2PF	2" PVC Hub	BI	1	4	\$52.00
822-3AF	3" ABS Hub	BI	1	4	\$52.00
822-3PF	3" PVC Hub	BI	1	4	\$52.00
<b>FINISH FIXTURE</b>					
832-3HHD	5-1/2" Hub Drain Finish Fixture	BI	1	10	\$15.64
832-3HNQ	5-7/8" Sqr Nikl-Brnz Ring & Strainer	BI	1	10	\$68.00
832-3HNR	5-1/2" Rnd Nikl-Brnz Ring & Strainer	BI	1	10	\$48.00
832-3HS	5-1/2" Rnd 18-Ga Stnls Steel Strainer	B	1	20	\$19.80
832-3HSQ	5-7/8" Sqr Stnls Steel Ring & Strainer	BI	1	10	\$68.00
832-3HSR	5-1/2" Rnd Stnls Steel Ring & Strainer	BI	1	10	\$48.00
<b>COMPLETE ASSEMBLY</b>					
822-F2ANQ	2" ABS Hub - 5-7/8" Sqr Nikl-Brnz Ring & Strainer	BI	1	1	\$120.00
822-F2ANR	2" ABS Hub - 5-1/2" Rnd Nikl-Brnz Ring & Strainer	BI	1	1	\$100.00
822-F2ASQ	2" ABS Hub - 5-7/8" Sqr Stnls Steel Ring & Strainer	BI	1	1	\$120.00
822-F2ASR	2" ABS Hub - 5-1/2" Rnd Stnls Steel Ring & Strainer	BI	1	1	\$100.00
822-F2PNQ	2" PVC Hub - 5-7/8" Sqr Nikl-Brnz Ring & Strainer	BI	1	1	\$120.00
822-F2PNR	2" PVC Hub - 5-1/2" Rnd Nikl-Brnz Ring & Strainer	BI	1	1	\$100.00
822-F2PSQ	2" PVC Hub - 5-7/8" Sqr Stnls Steel Ring & Strainer	BI	1	1	\$120.00
822-F2PSR	2" PVC Hub - 5-1/2" Rnd Stnls Steel Ring & Strainer	BI	1	1	\$100.00
822-F3ANQ	3" ABS Hub - 5-7/8" Sqr Nikl-Brnz Ring & Strainer	BI	1	1	\$120.00
822-F3ANR	3" ABS Hub - 5-1/2" Rnd Nikl-Brnz Ring & Strainer	BI	1	1	\$100.00
822-F3ASQ	3" ABS Hub - 5-7/8" Sqr Stnls Steel Ring & Strainer	BI	1	1	\$120.00
822-F3ASR	3" ABS Hub - 5-1/2" Rnd Stnls Steel Ring & Strainer	BI	1	1	\$100.00
822-F3PNQ	3" PVC Hub - 5-7/8" Sqr Nikl-Brnz Ring & Strainer	BI	1	1	\$120.00
822-F3PNR	3" PVC Hub - 5-1/2" Rnd Nikl-Brnz Ring & Strainer	BI	1	1	\$100.00
822-F3PSQ	3" PVC Hub - 5-7/8" Sqr Stnls Steel Ring & Strainer	BI	1	1	\$120.00
822-F3PSR	3" PVC Hub - 5-1/2" Rnd Stnls Steel Ring & Strainer	BI	1	1	\$100.00

Supply

Drainage

Support

Specialties

Appendix

**FinishLine Halo™ Floor Drains (Cont)**

**PVC/ABS - Sch. 40 Hub Connection**

Item Number	Item Description	Pkg Type	Min Qty	Case Qty	Price
<b>ACCESSORIES</b>					
822-CKIT	Clamping Collar Kit	BI	1	10	\$21.79
822-EX3	Ductile Iron Extension Adapter	B	1	1	\$35.33
832-EPS3	Extended ABS Coring Sleeve & Plug	BI	1	10	\$15.82
832-EX3	Ductile Iron Extension Adapter - 2" Min - 3-3/8" Max	BI	1	1	\$34.14
832-P	Coring Plug Wrench	BI	1	1	\$24.65
832-S3	Two Adjustment Shims, Two 3/4" Screws	BI	10	10	\$6.10
832-W	Flexible Red Locating Bristles w/ Screw	BI	10	10	\$7.26
835-2	Trapshield™ For 2" Drain Outlet	BI	1	50	\$56.31
835-3	Trapshield™ For 3" Drain Outlet	BI	1	25	\$63.36
863-FA	Round Aluminum Condensate Funnel w/ Screws	BI	1	12	\$49.15
863-FN	Round Nikl-Brnz Condensate Funnel w/ Screws	BI	1	12	\$109.99
863-FNO	Oval Nikl-Brnz Condensate Funnel w/ Screws	BI	1	12	\$243.96



822-EX3

Supply

Drainage

Support

Specialties

Appendix



835-2

**TrapShield™**

**Trap Protection Device**

Item Number	Item Description	Pkg Type	Min Qty	Case Qty	Price
835-2	Trapshield™ For 2" Drain Outlet	BI	1	50	\$56.31
835-3	Trapshield™ For 3" Drain Outlet	BI	1	25	\$63.36
835-35	Trapshield™ For 3-1/2" Drain Head	BI	1	25	\$63.36
835-4	Trapshield™ For 4" Drain Outlet	BI	1	20	\$74.98

**Replacement Strainers**

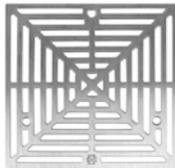

842-SNQ4



842-SCS3



842-SI4



842-SS4



842-SP3

Item Number	Item Description	Pkg Type	Min Qty	Case Qty	Price
<b>NICKEL-BRONZE STRAINERS</b>					
842-SN2	4" Dia. Rnd - 4.25 Sqr. Inch Free Area - 3" Screw Centers	BI	1	20	\$30.00
842-SN3	5-1/16" Dia. Rnd - 7.5 Sqr. Inch Free Area - 3-7/8" Screw Centers	BI	1	10	\$35.00
842-SN4	6-1/16" Dia. Rnd - 11.75 Sqr. Inch Free Area - 4-7/8" Screw Centers	BI	1	20	\$40.00
<b>842-SNQ2</b>	4" Dia. Sqr - 7.6 Sqr. Inch Free Area - 3" Screw Centers	BI	1	1	\$45.00
<b>842-SNQ3</b>	5-3/8" Dia. Sqr - 12.75 Sqr. Inch Free Area - 3-7/8" Screw Centers	BI	1	1	\$60.00
842-SNQ4	6-11/16" Dia. Sqr - 16.4 Sqr. Inch Free Area - 4-7/8" Screw Centers	BI	1	20	\$75.00
<b>CAST STAINLESS STEEL STRAINERS</b>					
<b>842-SCS2</b>	4" Dia. Rnd - 4.25 Sqr. Inch Free Area - 3" Screw Centers	BI	1	1	\$36.68
842-SCS3	5-1/8" Dia. Rnd - 7.5 Sqr. Inch Free Area - 3-7/8" Screw Centers	BI	1	10	\$54.88
<b>842-SCS4</b>	6-1/8" Dia. Rnd - 11.75 Sqr. Inch Free Area - 4-7/8" Screw Centers	BI	1	10	\$62.48
<b>842-SCSQ2</b>	4" Dia. Sqr - 7.6 Sqr. Inch Free Area - 3" Screw Centers	BI	1	1	\$51.85
<b>842-SCSQ3</b>	5-3/8" Dia. Sqr - 12.75 Sqr. Inch Free Area - 3-7/8" Screw Centers	BI	1	1	\$77.63
<b>842-SCSQ4</b>	6-1/2" Dia. Sqr - 16.4 Sqr. Inch Free Area - 4-7/8" Screw Centers	BI	1	1	\$100.38
<b>CAST IRON STRAINERS</b>					
842-SD4	6-1/16" Dia. Rnd - 13.25 Sqr. Inch Free Area - 4-7/8" Screw Centers	BI	1	1	\$16.23
<b>842-SI3</b>	5-5/8" Dia. Rnd - 6.81 Sqr. Inch Free Area	BI	1	10	\$28.50
<b>842-SI4</b>	6-3/16" Dia. Rnd - 9.58 Sqr. Inch Free Area	BI	1	2	\$31.00
<b>STAMPED STAINLESS STEEL STRAINERS</b>					
842-SS2	4" Dia. Rnd - 2.66 Sqr. Inch Free Area - 3" Screw Centers	BI	1	10	\$7.50
842-SS3	5-1/16" Dia. Rnd - 5.09 Sqr. Inch Free Area - 3-7/8" Screw Centers	BI	1	10	\$9.50
842-SS4	6-1/16" Dia. Rnd - 9.25 Sqr. Inch Free Area - 4-7/8" Screw Centers	BI	1	10	\$12.50
<b>GRAY ABS STRAINERS</b>					
<b>842-SP2</b>	4" Dia. Rnd - 4.18 Sqr. Inch Free Area - 3" Screw Centers	BI	1	1	\$8.00
842-SP3	5-1/16" Dia. Rnd - 5.15 Sqr. Inch Free Area - 3-7/8" Screw Centers	BI	1	10	\$10.00
842-SP4	6-1/16" Dia. Rnd - 8.74 Sqr. Inch Free Area - 4-7/8" Screw Centers	BI	1	10	\$13.00

## Floor Drain Adapters

### Trap Primer Adapters

Item Number	Item Description	Pkg Type	Min Qty	Case Qty	Price
<b>PVC/ABS - FIP X SCH. 40 HUB CONNECTION</b>					
842-82AT	2" ABS Hub w/ 1/2" FIP Trap Primer Port	BI	1	10	\$13.39
842-82PT	2" PVC Hub w/ 1/2" FIP Trap Primer Port	BI	1	10	\$13.39
<b>842-83AT</b>	3" ABS Hub w/ 1/2" FIP Trap Primer Port	BI	1	10	\$17.94
842-83PT	3" PVC Hub w/ 1/2" FIP Trap Primer Port	BI	1	10	\$17.94
842-84AT	4" ABS Hub w/ 1/2" FIP Trap Primer Port	BI	1	10	\$20.08
842-84PT	4" PVC Hub w/ 1/2" FIP Trap Primer Port	BI	1	10	\$20.08
<b>PVC/ABS - SCH. 40 HUB X SCH. 40 HUB CONNECTION</b>					
695-2A	2" ABS Hub Adapter w/ 1/2" FIP Port	BI	1	10	\$18.80
695-2P	2" PVC Hub Adapter w/ 1/2" FIP Port	BI	1	10	\$18.80
695-3A	3" ABS Hub Adapter w/ 1/2" FIP Port	B	1	10	\$21.32
695-3P	3" PVC Hub Adapter w/ 1/2" FIP Port	BI	1	10	\$21.32
695-4A	4" ABS Hub Adapter w/ 1/2" FIP Port	B	1	10	\$25.07
695-4P	4" PVC Hub Adapter w/ 1/2" FIP Port	BI	1	10	\$25.07



842-82PT



695-2P

## Floor Drain Adapters

### Flashing Drain Adapters

**Options:** Add suffix to item no. Add price to list  
 T = Tapped/plugged trap primer port for ABS/PVC: \$16.00;

Item Number	Item Description	Pkg Type	Min Qty	Case Qty	Price
<b>PVC/ABS - SCH. 40 HUB CONNECTION</b>					
863-HA23	2" ABS Hub w/ 3" FIP Thread	BI	1	10	\$43.43
<b>863-HA33</b>	3" ABS Hub w/ 3" FIP Thread	BI	1	10	\$43.43
<b>863-HA44</b>	4" ABS Hub w/ 4" FIP Thread	BI	1	10	\$43.43
863-HP23	2" PVC Hub w/ 3" FIP Thread	BI	1	10	\$43.43
<b>863-HP33</b>	3" PVC Hub w/ 3" FIP Thread	BI	1	10	\$43.43
863-HP34	3" PVC Hub w/ 4" FIP Thread	BI	1	10	\$43.43
863-HP44	4" PVC Hub w/ 4" FIP Thread	BI	1	10	\$43.43



863-HP23

## Condensate Funnels

Item Number	Item Description	Pkg Type	Min Qty	Case Qty	Price
<b>ROUND 4"</b>					
863-FA	Round Aluminum Condensate Funnel w/ Screws	BI	1	12	\$49.15
863-FN	Round Nikl-Brnz Condensate Funnel w/ Screws	BI	1	12	\$109.99
<b>OVAL 4" X 9"</b>					
863-FNO	Oval Nikl-Brnz Condensate Funnel w/ Screws	BI	1	12	\$243.96



863-FA

Supply

Drainage

Support

Specialties

Appendix



850-VW1

### Vandal-Resistant Strainer Screws

Item Number	Item Description	Pkg Type	Min Qty	Case Qty	Price
<b>#10-24 SIZE</b>					
850-V105	1/2" Stainless, 12/Bag	BI	1	25	\$17.87
850-V106	5/8" Stainless, 12/Bag	BI	1	25	\$17.87
<b>850-V109</b>	1" Stainless, 12/Bag	BI	1	1	\$17.87
850-VW1	#10 Span Bit For #10-24 Vandal-Resistant Screws	BI	10	100	\$21.05
<b>1/4-20 SIZE</b>					
850-V407	3/4" Stainless	BI	1	1	\$4.50
850-V415	1-1/2" Stainless	BI	1	1	\$4.08
850-V425	2-1/2" Stainless	BI	1	1	\$4.08
<b>850-VW4</b>	#14 Span Bit For 1/4-20 Vandal-Resistant Screws	BI	10	10	\$21.05



# Commercial Floor Sinks

**SquareMax™ Square Floor Sinks**

**FatMax™ Round Floor Sinks**

**LittleMax™ Compact Floor Sinks**

Sioux Chief's PVC floor sinks are made from a tough, impact-modified PVC resin. They are corrosion-resistant and withstand water temperatures up to 180°F without distortion.





**PVC - Sch. 40 Hub Connection**

**Floor Sinks**

**Options:** Add suffix to item no. Add price to list

**D** = ABS Dome Bottom Strainer (1): \$10.00; **U** = Aluminum Dome Bottom Strainer (1): \$22.00;

**C** = PVC Clamping Collar: \$20.00; **W** = Stainless Steel Debris Basket: \$60.00;

**2** = Open-Half Strainer (2): N/C; **3** = Open-Quarter Strainer (2): N/C;

**V** = Vandal-Resistant Strainer (2): \$12.00; **T** = Tapped Trap Primer Connection - 1/2" FIP: \$12.00;

**F** = Round Nickel-Bronze Condensate Funnel: \$108.00; **FA** = Round Aluminum Condensate Funnel: \$48.00;

**FO** = Oval Nickel-Bronze Condensate Funnel: \$238.00; **6** = ABS Flat Strainer for Drain Outlet (1): \$12.00;

1: Not available for 6" sinks 2: Available for sinks with PVC, NB, and SS strainers only



861-2PX



861-2P



861-3PN



861-2PZ

Item Number	Item Description	Pkg Type	Min Qty	Case Qty	Price
<b>SINK ONLY - NO STRAINER</b>					
861-2PX	2" Hub	Bl	1	3	\$65.15
861-2PXR	2" Hub - No Anchor Flange	Bl	1	3	\$65.15
861-3PX	3" Hub	Bl	1	3	\$65.15
861-3PXR	3" Hub - No Anchor Flange	Bl	1	3	\$65.15
861-4PX	4" Hub	Bl	1	3	\$65.15
861-6PX	6" Hub	Bl	1	2	\$166.47
<b>PVC STRAINER</b>					
861-2P	2" Hub - 11-3/16" Sqr Grate	Bl	1	1	\$97.72
861-2PR	2" Hub - 11-3/16" Sqr Grate - No Anchor Flange	Bl	1	1	\$97.72
861-3P	3" Hub - 11-3/16" Sqr Grate	Bl	1	1	\$97.72
861-3PR	3" Hub - 11-3/16" Sqr Grate - No Anchor Flange	Bl	1	1	\$97.72
861-4P	4" Hub - 11-3/16" Sqr Grate	Bl	1	1	\$97.72
861-6P	6" Hub - 11-3/16" Sqr Grate	Bl	1	1	\$199.04
<b>NICKEL-BRONZE RING &amp; STRAINER</b>					
861-2PN	2" Hub - 11-3/4" Sqr Grate	Bl	1	1	\$571.82
861-3PN	3" Hub - 11-3/4" Sqr Grate	Bl	1	1	\$571.82
861-4PN	4" Hub - 11-3/4" Sqr Grate	Bl	1	1	\$571.82
861-6PN	6" Hub - 11-3/4" Sqr Grate	Bl	1	1	\$673.14
<b>STAINLESS STEEL RING &amp; STRAINER</b>					
861-2PZ	2" Hub - 11-3/4" Sqr Grate	Bl	1	1	\$571.82
861-3PZ	3" Hub - 11-3/4" Sqr Grate	Bl	1	1	\$571.82
861-4PZ	4" Hub - 11-3/4" Sqr Grate	Bl	1	1	\$571.82
861-6PZ	6" Hub - 11-3/4" Sqr Grate	Bl	1	1	\$673.14
<b>DUCTILE IRON RING &amp; STRAINER</b>					
861-2PI	2" Hub - 11-3/4" Sqr Grate	Bl	1	1	\$249.72
861-3PI	3" Hub - 11-3/4" Sqr Grate	Bl	1	1	\$249.72
861-4PI	4" Hub - 11-3/4" Sqr Grate	Bl	1	1	\$249.72
861-6PI	6" Hub - 11-3/4" Sqr Grate	Bl	1	1	\$351.04

Supply

Drainage

Support

Specialties

Appendix

SquareMax™ Floor Sink Accessories

Item Number	Item Description	Pkg Type	Min Qty	Case Qty	Price
<b>STRAINERS</b>					
861-5	PVC Full Strainer w/ Lift Handle	BI	1	15	\$32.58
861-51	PVC Open-Half Strainer	BI	1	15	\$24.97
861-51AR	PVC Open-Half Strainer w/ Adjustable Ring	BI	1	10	\$75.00
861-51NR	Nikl-Brnz Ring & Open-Half Strainer	BI	1	3	\$530.00
861-51SR	Stnls Steel Ring & Open-Half Strainer	BI	1	3	\$437.53
861-53	PVC Open-Quarter Strainer	BI	1	15	\$28.96
861-53N	Nikl-Brnz Open-Quarter Strainer Only	BI	1	1	\$279.43
861-53NR	Nikl-Brnz Ring & Open-Quarter Strainer	BI	1	3	\$530.00
861-5AR	PVC Full Strainer w/ Adjustable Ring	BI	1	10	\$75.00
<b>861-5CI</b>	Heel-Proof, Ductile Iron Ring & Full Strainer	BI	1	3	\$189.56
861-5NR	Nikl-Brnz Ring & Full Strainer	BI	1	3	\$530.00
<b>861-5SR</b>	Stnls Steel Ring & Full Strainer	BI	1	1	\$530.80
<b>ACCESSORIES</b>					
861-6	Flat Secondary Strainer - White ABS	BI	1	10	\$11.58
861-C	PVC Clamping Collar w/ Stainless Steel Bolts	BI	1	5	\$18.93
861-D	Dome Bottom Strainer - White ABS	BI	1	80	\$9.42
861-UM	Stainless Steel Debris Basket	BI	1	5	\$60.67
863-FA	Round Aluminum Condensate Funnel w/ Screws	BI	1	12	\$49.15
863-FN	Round Nikl-Brnz Condensate Funnel w/ Screws	BI	1	12	\$109.99
863-FNO	Oval Nikl-Brnz Condensate Funnel w/ Screws	BI	1	12	\$243.96
863-U	Aluminum Dome Bottom Strainer (Not For 6" Conn.)	BI	1	5	\$21.73

Supply

Drainage

Support

Specialties

Appendix

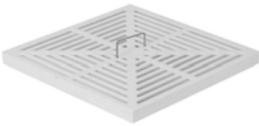

861-5



861-51NR

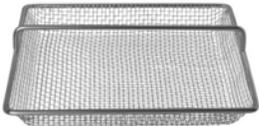

861-UM



863-FNO



863-U

**PVC - Sch. 40 Hub Connection**

**Floor Sinks**

**Options:** Add suffix to item no. Add price to list

**S** = ABS Sand Bucket: \$14.00; **U** = ABS Debris Bucket: \$14.00;

**C** = ABS Clamping Collar: \$17.00; **D** = ABS Dome Bottom Strainer: \$10.00;

**V** = Vandal-Resistant Strainer (1): \$12.00; **T** = Tapped Trap Primer Connection - 1/2" FIP: \$12.00;

**2** = Open-Half Strainer (1): N/C; **3** = Open-Quarter Strainer (2): N/C;

**W** = Stainless Steel Debris Basket: \$52.00; **F** = Round Nickel-Bronze Condensate Funnel: \$108.00;

**FA** = Round Aluminum Condensate Funnel: \$48.00; **FO** = Oval Nickel-Bronze Condensate Funnel: \$238.00;

**J** = Solid (gray) PVC Cover with Lift Handle (3): \$45.00; **6** = ABS Flat Strainer for Drain Outlet: \$12.00;

**L** = Aluminum Dome Bottom Strainer: \$22.00;

1: Not available for iron strainers 2: For PVC Strainers Only 3: For sinks with NO strainer only



860-W2P



860-W2PN

Item Number	Item Description	Pkg Type	Min Qty	Case Qty	Price
<b>SINK ONLY - NO STRAINER</b>					
860-W2PX	2" White PVC Hub - 9" Rnd Grate	Bl	1	4	\$53.20
860-W3PX	3" White PVC Hub - 9" Rnd Grate	Bl	1	4	\$53.20
860-W4PX	4" White PVC Hub - 9" Rnd Grate	Bl	1	4	\$53.20
<b>PVC STRAINER</b>					
860-W2P	2" White PVC Hub - 9" Rnd Grate	Bl	1	4	\$83.25
860-W3P	3" White PVC Hub - 9" Rnd Grate	Bl	1	4	\$83.25
860-W4P	4" White PVC Hub - 9" Rnd Grate	Bl	1	4	\$83.25
<b>NICKEL-BRONZE RING &amp; STRAINER</b>					
860-W2PN	2" White PVC Hub - 9-3/4" Rnd Grate	Bl	1	1	\$343.80
860-W3PN	3" White PVC Hub - 9-3/4" Rnd Grate	Bl	1	4	\$343.80
860-W4PN	4" White PVC Hub - 9-3/4" Rnd Grate	Bl	1	4	\$343.80
<b>STAINLESS STEEL RING &amp; STRAINER</b>					
860-W2PZ	2" White PVC Hub - 9-3/4" Rnd Grate	Bl	1	1	\$343.80
860-W3PZ	3" White PVC Hub - 9-3/4" Rnd Grate	Bl	1	1	\$343.80
<b>DUCTILE IRON RING &amp; STRAINER</b>					
860-W2PI	2" White PVC Hub - 9-7/8" Rnd Grate	Bl	1	1	\$148.39
860-W3PI	3" White PVC Hub - 9-7/8" Rnd Grate	Bl	1	2	\$148.39
860-W4PI	4" White PVC Hub - 9-7/8" Rnd Grate	Bl	1	2	\$148.39

**FatMax™ Floor Sink Accessories**

Item Number	Item Description	Pkg Type	Min Qty	Case Qty	Price
<b>STRAINERS</b>					
860-GI	Cast Iron Full Strainer Only	Bl	1	5	\$87.22
860-GN2	Nikl-Brnz Open-Half Strainer Only	Bl	1	1	\$147.86
860-GN3	Nikl-Brnz Open-Quarter Strainer Only	Bl	1	1	\$173.28
860-RGN	Nckl-Brnz Ring And Full Strainer	Bl	1	1	\$305.00
860-RGN2	Nikl-Brnz Ring And Open-Half Strainer	Bl	1	1	\$305.00
860-RGS	304 Stnls Steel Ring And Full Strainer	Bl	1	1	\$305.00
860-RGS2	304 Stnls Steel Ring And Open-Half Strainer	Bl	1	1	\$305.00
860-WGP	PVC Full Strainer w/ Lift Handle	Bl	1	16	\$36.19
860-WGP2	PVC Open-Half Strainer	Bl	1	10	\$28.96
860-WGP3	PVC Open-Quarter Strainer	Bl	1	10	\$33.29
860-WGPJ	PVC Full Cover	Bl	1	16	\$43.43



860-WGP2



860-RGS

**FatMax™ Floor Sink Accessories (Cont)**

Item Number	Item Description	Pkg Type	Min Qty	Case Qty	Price
<b>ACCESSORIES</b>					
860-C	Clamping Collar w/ Screws - Gray ABS	BI	1	10	\$14.85
860-UM	Stainless Steel Debris Basket	BI	1	5	\$53.08
<b>860-WS</b>	Sand Bucket For Sump Area - White PVC	BI	1	20	\$14.10
<b>860-WU</b>	Debris Bucket For Sump Area - White PVC	BI	1	20	\$14.10
861-6	Flat Secondary Strainer - White ABS	BI	1	10	\$11.58
861-D	Dome Bottom Strainer - White ABS	BI	1	80	\$9.42
863-FA	Round Aluminum Condensate Funnel w/ Screws	BI	1	12	\$49.15
863-FN	Round Nikl-Brnz Condensate Funnel w/ Screws	BI	1	12	\$109.99
863-FNO	Oval Nikl-Brnz Condensate Funnel w/ Screws	BI	1	12	\$243.96
863-U	Aluminum Dome Bottom Strainer (Not For 6" Conn.)	BI	1	5	\$21.73

Supply



860-C

Drainage



860-WS

Support



860-WU

Specialties



861-D

Appendix

**PVC - Sch. 40 Hub Connection**

**Options:** Add suffix to item no. Add price to list

**V** = Vandal-Resistant Strainer: \$12.00; **T** = Tapped Trap Primer Connection - 1/2" FIP: \$8.00;

**S** = Sand Bucket: \$12.00; **U** = Stainless Steel Debris Basket for Sump Area: \$41.00;

**2** = Open-Half Strainer: \$20.00; **3** = Open-Quarter Strainer: \$20.00;

**X** = Less Strainer: N/C;

Item Number	Item Description	Pkg Type	Min Qty	Case Qty	Price
<b>FLOOR SINKS</b>					
864-W2P	2" Hub - 6-5/8" Rnd PVC Grate	BI	1	3	\$55.15
864-W3P	3" Hub - 6-5/8" Rnd PVC Grate	BI	1	3	\$55.15
<b>864-W4P</b>	4" Hub - 6-5/8" Rnd PVC Grate	BI	1	3	\$55.15
<b>ACCESSORIES</b>					
863-FA	Round Aluminum Condensate Funnel w/ Screws	BI	1	12	\$49.15
863-FN	Round Nikl-Brnz Condensate Funnel w/ Screws	BI	1	12	\$109.99
863-FNO	Oval Nikl-Brnz Condensate Funnel w/ Screws	BI	1	12	\$243.96
864-UM	Stainless Steel Mesh Debris Basket	BI	1	10	\$41.36
864-WGP	PVC Strainer w/ Lift Handle, Loose Set	BI	1	1	\$19.99
<b>864-WGP2</b>	Open-Half PVC Strainer, Loose Set	BI	1	1	\$39.99
864-WS	PVC Sand Bucket (Fits Inside Sump Area)	BI	1	10	\$12.41



864-W2P

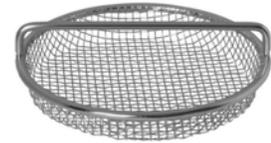

864-UM

Supply

Drainage

Support

Specialties

Appendix





# Commercial Roof Drains

**Roof Drains**

**Planter Area Drains**





## 11" Roof Drain

### PVC/ABS - Sch. 40 Hub Connection

**Options:** Add suffix to item no. Add price to list

**V** = Vandal-Resistant Dome: \$12.00; **W** = 2-3/16" High External Water Dam: \$125.00;  
**P** = Steel Screen Installed over Dome Strainer: \$75.00; **STP2** = 2" High Internal Water Dam: \$150.00;  
**U** = Underdeck Clamp Kit: \$85.00; **S** = Sump Receiver: \$67.00;  
**E** = Extension Collar Kit: \$78.00;



868-P3

Item Number	Item Description	Pkg Type	Min Qty	Case Qty	Price
<b>ROOF DRAINS WITH POLY DOME STRAINER</b>					
868-A3	3" ABS Hub	Bl	1	2	\$129.64
<b>868-A4</b>	4" ABS Hub	Bl	1	2	\$129.64
<b>868-A6</b>	6" ABS Hub	Bl	1	2	\$142.29
868-P3	3" PVC Hub	Bl	1	2	\$129.64
868-P4	4" PVC Hub	Bl	1	2	\$129.64
868-P6	6" PVC Hub	Bl	1	2	\$142.29
<b>ROOF DRAINS WITH ALUMINUM DOME STRAINER</b>					
<b>868-A3M</b>	3" ABS Hub	Bl	1	2	\$189.58
<b>868-A4M</b>	4" ABS Hub	Bl	1	2	\$189.58
<b>868-A6M</b>	6" ABS Hub	Bl	1	2	\$202.24
868-P3M	3" PVC Hub	Bl	1	2	\$189.58
868-P4M	4" PVC Hub	Bl	1	2	\$189.58
868-P6M	6" PVC Hub	Bl	1	2	\$202.24
<b>ACCESSORIES</b>					
868-C	Under Deck Clamp Kit: 11" Epoxy-Coated Clamping Plate, Thread Rod, Nuts & Washers	Bl	1	5	\$86.00
868-E	Extension Collar Kit: Extension Collar Plate, Thread Rod, Nuts & Washers	Bl	1	5	\$78.51
868-HD	Dome Strainer - 9-1/4" Diameter, Polyethylene	Bl	1	5	\$26.04
868-MC	Epoxy-Coated Aluminum Replacement Gravel Guard	Bl	1	10	\$97.10
868-MD	Dome Strainer - 9-1/4" Diameter, Cast Aluminum	Bl	1	5	\$94.61
868-S	Sump Receiver: 11-1/2" Sump Receiver Plate	Bl	1	10	\$67.58
868-WD	Epoxy-Coated Aluminum External Water Dam, 2-3/16"	Bl	1	1	\$132.88

Supply

Drainage

Support

Specialties

Appendix



867-P2

## 10" Roof Drain

### PVC/ABS - Sch. 40 Hub Connection

**Options:** Add suffix to item no. Add price to list

**V** = Vandal-Resistant Dome: \$12.00; **P** = Steel Screen Installed over Dome Strainer: \$75.00;

**C** = Ductile Iron Gravel Guard (1): \$35.00; **STP2** = 2" High Internal Water Dam: \$125.00;

**U** = Underdeck Clamp Kit: \$38.00;

1: In lieu of PVC (standard)

Item Number	Item Description	Pkg Type	Min Qty	Case Qty	Price
<b>ROOF DRAINS WITH POLY DOME STRAINER</b>					
<b>867-A2</b>	2" ABS Hub	BI	2	2	\$60.92
867-A3	3" ABS Hub	BI	2	2	\$60.92
867-A4	4" ABS Hub	BI	2	2	\$60.92
867-P2	2" PVC Hub	BI	2	2	\$60.92
867-P3	3" PVC Hub	BI	2	2	\$60.92
867-P4	4" PVC Hub	BI	2	2	\$60.92
<b>ROOF DRAINS WITH CAST IRON DOME STRAINER</b>					
<b>867-A2M</b>	2" ABS Hub	BI	2	2	\$89.59
<b>867-A3M</b>	3" ABS Hub	BI	2	2	\$89.59
<b>867-A4M</b>	4" ABS Hub	BI	2	2	\$89.59
<b>867-P2M</b>	2" PVC Hub	BI	2	2	\$89.59
867-P3M	3" PVC Hub	BI	2	2	\$89.59
867-P4M	4" PVC Hub	BI	2	2	\$89.59
<b>ACCESSORIES</b>					
867-C	Underdeck Clamp Kit	BI	1	25	\$38.00
867-HC	PVC Replacement Gravel Guard	BI	1	5	\$16.49
867-HD	7-1/2" Diameter, Polypro Dome	BI	1	5	\$15.06
867-MC	Ductile Iron Replacement Gravel Guard	BI	1	1	\$33.72
867-MD	7-1/2" Diameter, Cast Iron Dome	BI	1	5	\$52.46
867-UM	Stainless Steel Dome Screen	BI	1	1	\$75.09

## 8" Roof Drain & Overflow - Cast Iron Dome

### Cast Iron - No-Hub Connection

Item Number	Item Description	Pkg Type	Min Qty	Case Qty	Price
867-DI2	2" No-Hub Roof Drain & Overflow Combo	BI	1	1	\$140.30
867-DI3	3" No-Hub Roof Drain & Overflow Combo	BI	1	1	\$140.30
867-DI4	4" No-Hub Roof Drain & Overflow Combo	BI	1	1	\$140.30



867-DI2

Supply

Drainage

Support

Specialties

Appendix

Supply

Drainage

Support

Specialties

Appendix



867-L3PP



867-C

### PVC/ABS - Sch. 40 Hub Connection

Item Number	Item Description	Pkg Type	Min Qty	Case Qty	Price
<b>PLANTER-AREA DRAINS</b>					
867-L3AP	3" ABS Hub, Poly Dome Strainer w/ SS Screen	BI	1	1	\$164.86
867-L3PP	3" PVC Hub, Poly Dome Strainer w/ SS Screen	BI	1	1	\$164.86
<b>867-L4AP</b>	4" ABS Hub, Poly Dome Strainer w/ SS Screen	BI	1	1	\$164.86
867-L4PP	4" PVC Hub, Poly Dome Strainer w/ SS Screen	BI	1	1	\$164.86
<b>ACCESSORIES</b>					
867-C	Underdeck Clamp Kit	BI	1	25	\$38.00
867-HC	PVC Replacement Gravel Guard	BI	1	5	\$16.49
867-MC	Ductile Iron Replacement Gravel Guard	BI	1	1	\$33.72
867-UM	Stainless Steel Dome Screen	BI	1	1	\$75.09

# Commercial Cleanouts

**FinishLine™ Adjustable Cleanouts**

**Access Cover Cleanouts**

**Halo™ Cleanouts**

**Wall Cleanouts**

**Cleanout Bushing**

**Plugs/Accessories**

FinishLine™ Cleanouts are adjustable both before and AFTER the concrete pour.



The FinishLine virtually eliminates cleanouts set too low or not level. Installations are faster, easier, and more professional looking.



**834-4PNQ**  
Page 369



**852-4PI**  
Page 370



**852-3LNQ**  
Page 370



**822-C3PSR**  
Page 372



**822-CF3PNR**  
Page 373



**851-44N**  
Page 374



**850-3T**  
Page 375



**870-3**  
Page 376



**871-4**  
Page 376



**873-240**  
Page



**875-3P**  
Page 378



**875-84PN**  
Page 378



**878-20**  
Page 379



**878-S30**  
Page 380



**876-30**  
Page



**852-CN3**  
Page 381



**PVC/ABS - Sch. 40 Hub Connection**

**6-1/2" Tops**

**Options:** Add suffix to item no. Add price to list

**V** = Vandal-Resistant Cover: \$6.50; **S** = Stamping: Specify Letters: \$12.50;

**C** = Carpet Marker: \$16.00; **B** = Brass Cleanout Plug (1): \$12.00;

**Z** = Complies with Buy American Act (2): \$62.00;

1: In lieu of polypro (standard) 2: For round nickel-bronze ring/cover only



834-4AF



834-3PNQ

Item Number	Item Description	Pkg Type	Min Qty	Case Qty	Price
<b>ROUGH-IN FIXTURE</b>					
834-3AF	3" ABS Hub	Bl	1	10	\$27.47
834-3PF	3" PVC Hub	Bl	1	10	\$27.47
834-4AF	4" ABS Hub	Bl	1	10	\$27.47
834-4PF	4" PVC Hub	Bl	1	10	\$27.47
<b>FINISH FIXTURE</b>					
834-4HNQ	6-5/8" Sqr Nikl-Brnz Ring & Cover	Bl	1	10	\$106.73
834-4HNR	6-1/2" Rnd Nikl-Brnz Ring & Cover	Bl	1	10	\$81.77
834-4HPR	6-1/2" Rnd Gray ABS Ring & Cover	Bl	1	1	\$81.77
834-4HSQ	6-5/8" Sqr Stnls Steel Ring & Cover	Bl	1	10	\$106.73
834-4HSR	6-1/2" Rnd Stnls Steel Ring & Cover	Bl	1	10	\$81.77
<b>COMPLETE ASSEMBLY</b>					
834-3ANQ	3" Hub - 6-5/8" Sqr Nikl-Brnz Ring & Cover	Bl	1	1	\$134.20
834-3ANR	3" Hub - 6-1/2" Rnd Nikl-Brnz Ring & Cover	Bl	1	1	\$109.24
834-3ASQ	3" Hub - 6-5/8" Sqr Stnls Steel Ring & Cover	Bl	1	1	\$134.20
834-3ASR	3" Hub - 6-1/2" Rnd Stnls Steel Ring & Cover	Bl	1	1	\$109.24
834-3PNQ	3" Hub - 6-5/8" Sqr Nikl-Brnz Ring & Cover	Bl	1	1	\$134.20
834-3PNR	3" Hub - 6-1/2" Rnd Nikl-Brnz Ring & Cover	Bl	1	1	\$109.24
834-3PSQ	3" Hub - 6-5/8" Sqr Stnls Steel Ring & Cover	Bl	1	1	\$134.20
834-3PSR	3" Hub - 6-1/2" Rnd Stnls Steel Ring & Cover	Bl	1	1	\$109.24
834-4ANQ	4" Hub - 6-5/8" Sqr Nikl-Brnz Ring & Cover	Bl	1	1	\$134.20
834-4ANR	4" Hub - 6-1/2" Rnd Nikl-Brnz Ring & Cover	Bl	1	1	\$109.24
834-4ASQ	4" Hub - 6-5/8" Sqr Stnls Steel Ring & Cover	Bl	1	1	\$134.20
834-4ASR	4" Hub - 6-1/2" Rnd Stnls Steel Ring & Cover	Bl	1	1	\$109.24
834-4PNQ	4" Hub - 6-5/8" Sqr Nikl-Brnz Ring & Cover	Bl	1	1	\$134.20
834-4PNR	4" Hub - 6-1/2" Rnd Nikl-Brnz Ring & Cover	Bl	1	1	\$109.24
834-4PSQ	4" Hub - 6-5/8" Sqr Stnls Steel Ring & Cover	Bl	1	1	\$134.20
834-4PSR	4" Hub - 6-1/2" Rnd Stnls Steel Ring & Cover	Bl	1	1	\$109.24
<b>ACCESSORIES</b>					
832-EX4	Ductile Iron Extension Adapter - 2" Min - 4" Max	Bl	1	1	\$34.14
832-S4	Two Adjustment Shims, Two 3/4" Screws	Bl	10	10	\$6.10
832-W	Flexible Red Locating Bristles w/ Screw	Bl	10	10	\$7.26

Supply

Drainage

Support

Specialties

Appendix



852-3ANR



852-3PSQ



852-4PI



852-3LNQ

### PVC/ABS - Sch. 40 Hub Connection

**Options:** Add suffix to item no. Add price to list

**V** = Vandal-Resistant Cover: \$6.50; **S** = Stamping: Specify Letters (1): \$12.50;

**Z** = Complies with Buy American Act (2): \$62.00; **C** = Carpet Marker: \$16.00;

**H** = Special-Duty Cover (15,000 lbs. safe load) (3): \$39.75; **Y** = Ductile Iron Head Adapter (4): \$26.00;

1: Not available for iron covers. 2: For round nickel-bronze ring/cover only 3: Not available for stainless steel covers 4: In lieu of ABS (standard)

Item Number	Item Description	Pkg Type	Min Qty	Case Qty	Price
<b>NICKEL-BRONZE RING &amp; COVER</b>					
852-3ANQ	3" ABS Hub - 6-5/8" Sqr Ring & Cover	BI	1	1	\$140.00
852-3ANR	3" ABS Hub - 6-1/2" Rnd Ring & Cover	BI	1	5	\$110.00
852-3PNQ	3" PVC Hub - 6-5/8" Sqr Ring & Cover	BI	1	2	\$140.00
852-3PNR	3" PVC Hub - 6-1/2" Rnd Ring & Cover	BI	1	5	\$110.00
852-4ANQ	4" ABS Hub - 6-5/8" Sqr Ring & Cover	BI	1	1	\$140.00
852-4ANR	4" ABS Hub - 6-1/2" Rnd Ring & Cover	BI	1	10	\$110.00
852-4PNQ	4" PVC Hub - 6-5/8" Sqr Ring & Cover	BI	1	2	\$140.00
852-4PNR	4" PVC Hub - 6-1/2" Rnd Ring & Cover	BI	1	10	\$110.00
<b>STAINLESS STEEL RING &amp; COVER</b>					
852-3ASQ	3" ABS Hub - 6-5/8" Sqr Ring & Cover	BI	1	1	\$140.00
852-3ASR	3" ABS Hub - 6-1/2" Rnd Ring & Cover	BI	1	5	\$110.00
852-3PSQ	3" PVC Hub - 6-5/8" Sqr Ring & Cover	BI	1	1	\$140.00
852-3PSR	3" PVC Hub - 6-1/2" Rnd Ring & Cover	BI	1	1	\$110.00
852-4ASQ	4" ABS Hub - 6-5/8" Sqr Ring & Cover	BI	1	1	\$140.00
852-4ASR	4" ABS Hub - 6-1/2" Rnd Ring & Cover	BI	1	1	\$110.00
852-4PSQ	4" PVC Hub - 6-5/8" Sqr Ring & Cover	BI	1	2	\$140.00
852-4PSR	4" PVC Hub - 6-1/2" Rnd Ring & Cover	BI	1	10	\$110.00
<b>CAST IRON RING &amp; COVER</b>					
852-3AI	3" ABS Hub - 6-1/2" Rnd Ring & Cover	BI	1	1	\$65.00
852-3PI	3" PVC Hub - 6-1/2" Rnd Ring & Cover	BI	2	2	\$65.00
852-4AI	4" ABS Hub - 6-1/2" Rnd Ring & Cover	BI	1	1	\$65.00
852-4PI	4" PVC Hub - 6-1/2" Rnd Ring & Cover	BI	2	2	\$65.00

### ABS - MIP Thread Connection

**Options:** Add suffix to item no. Add price to list

**V** = Vandal-Resistant Cover: \$6.50; **S** = Stamping: Specify Letters (1): \$12.50;

1: Not available for iron covers.

Item Number	Item Description	Pkg Type	Min Qty	Case Qty	Price
<b>NICKEL-BRONZE RING &amp; COVER</b>					
852-2LNR	2" ABS MIP - 4-1/2" Rnd Ring & Cover	BI	1	10	\$65.00
852-3LNQ	3" ABS MIP - 5-7/8" Sqr Ring & Cover	BI	1	5	\$117.00
852-3LNR	3" ABS MIP - 5-1/2" Rnd Ring & Cover	BI	1	10	\$80.00
852-4LNQ	4" ABS MIP - 6-5/8" Sqr Ring & Cover	BI	1	1	\$144.00
852-4LNR	4" ABS MIP - 6-1/2" Rnd Ring & Cover	BI	1	10	\$114.00
852-4LNRPK	4" ABS MIP - 6-1/2" Rnd Ring & Cover	CI	5	5	\$115.00

**ABS - MIP Thread Connection (Cont)**

Item Number	Item Description	Pkg Type	Min Qty	Case Qty	Price
<b>STAINLESS STEEL RING &amp; COVER</b>					
852-3LSQ	3" ABS MIP - 5-7/8" Sqr Ring & Cover	BI	1	1	\$117.00
852-3LSR	3" ABS MIP - 5-1/2" Rnd Ring & Cover	BI	1	10	\$80.00
852-4LSQ	4" ABS MIP - 6-5/8" Sqr Ring & Cover	BI	1	1	\$144.00
852-4LSR	4" ABS MIP - 6-1/2" Rnd Ring & Cover	BI	1	1	\$114.00
<b>CAST IRON RING &amp; COVER</b>					
852-3LI	3" ABS MIP - 6-1/8" Rnd Ring & Cover	BI	2	2	\$57.00
852-4LI	4" ABS MIP - 6-1/2" Rnd Ring & Cover	BI	2	2	\$60.00
<b>GRAY ABS COVER</b>					
852-3LP	3" ABS MIP - 5-1/2" Rnd Ring & Cover	BI	1	10	\$35.00
852-4LP	4" ABS MIP - 6-1/2" Rnd Ring & Cover	BI	1	1	\$38.00



852-3LSR



852-4LI



852-3LP

Supply

Drainage

Support

Specialties

Appendix



822-C3ANR



822-C3ASR

### Halo™ Adjustable Cleanouts

#### PVC/ABS - Sch. 40 Hub Connection

**Options:** Add suffix to item no. Add price to list

**V** = Vandal-Resistant Cover: \$6.50; **S** = Stamping: Specify Letters: \$12.50;

**C** = Carpet Marker: \$16.00; **Z** = Complies with Buy American Act (1): \$62.00;

1: For round nickel-bronze ring/cover only

Item Number	Item Description	Pkg Type	Min Qty	Case Qty	Price
<b>NICKEL-BRONZE RING &amp; COVER</b>					
822-C3ANQ	3" ABS Hub - 5-7/8" Sqr Ring & Cover	BI	1	1	\$125.00
822-C3ANR	3" ABS Hub - 5-1/2" Rnd Ring & Cover	BI	1	1	\$95.00
822-C3PNQ	3" PVC Hub - 5-7/8" Sqr Ring & Cover	BI	1	1	\$125.00
822-C3PNR	3" PVC Hub - 5-1/2" Rnd Ring & Cover	BI	1	4	\$95.00
822-C4ANQ	Inside 4" ABS - 5-7/8" Sqr Ring & Cover	BI	1	1	\$150.00
822-C4ANR	Inside 4" ABS - 5-1/2" Rnd Ring & Cover	BI	1	1	\$120.00
822-C4PNQ	Inside 4" PVC - 5-7/8" Sqr Ring & Cover	BI	1	1	\$150.00
822-C4PNR	Inside 4" PVC - 5-1/2" Rnd Ring & Cover	BI	1	1	\$120.00
<b>STAINLESS STEEL RING &amp; COVER</b>					
822-C3ASQ	3" ABS Hub - 5-7/8" Sqr Ring & Cover	BI	1	1	\$125.00
822-C3ASR	3" ABS Hub - 5-1/2" Rnd Ring & Cover	BI	1	1	\$95.00
822-C3PSQ	3" PVC Hub - 5-7/8" Sqr Ring & Cover	BI	1	1	\$125.00
822-C3PSR	3" PVC Hub - 5-1/2" Rnd Ring & Cover	BI	1	4	\$95.00
822-C4ASQ	Inside 4" ABS - 5-7/8" Sqr Ring & Cover	BI	1	1	\$150.00
822-C4ASR	Inside 4" ABS - 5-1/2" Rnd Ring & Cover	BI	1	1	\$120.00
822-C4PSQ	Inside 4" PVC - 5-7/8" Sqr Ring & Cover	BI	1	1	\$150.00
822-C4PSR	Inside 4" PVC - 5-1/2" Rnd Ring & Cover	BI	1	4	\$120.00
<b>ACCESSORIES</b>					
822-EX3	Ductile Iron Extension Adapter	B	1	1	\$35.33

### FinishLine Halo™ Adjustable Cleanouts

#### PVC/ABS - Sch. 40 Hub Connection

**Options:** Add suffix to item no. Add price to list

**V** = Vandal-Resistant Cover: \$6.50; **S** = Stamping: Specify Letters: \$12.50;

**C** = Carpet Marker: \$16.00; **Z** = Complies with Buy American Act (1): \$62.00;

1: For round nickel-bronze ring/cover only



822-C3PF



834-3HSQ

Item Number	Item Description	Pkg Type	Min Qty	Case Qty	Price
<b>ROUGH-IN FIXTURE</b>					
822-C3AF	3" ABS Hub	BI	1	1	\$60.00
822-C3PF	3" PVC Hub	BI	1	1	\$60.00
<b>FINISH FIXTURE</b>					
834-3HNQ	5-7/8" Sqr Nikl-Brnz Ring & Cover	BI	1	1	\$90.00
834-3HNR	5-1/2" Rnd Nikl-Brnz Ring & Cover	BI	1	10	\$60.00
834-3HSQ	5-7/8" Sqr Stnls Steel Ring & Cover	BI	1	1	\$90.00
834-3HSR	5-1/2" Rnd Stnls Steel Ring & Cover	BI	1	1	\$60.00

## FinishLine Halo™ Adjustable Cleanouts (Cont)

### PVC/ABS - Sch. 40 Hub Connection

Item Number	Item Description	Pkg Type	Min Qty	Case Qty	Price
<b>COMPLETE ASSEMBLY</b>					
822-CF3ANQ	3" ABS Hub - 5-7/8" Sqr Nikl-Brnz Ring & Cover	Bl	1	1	\$150.00
822-CF3ANR	3" ABS Hub - 5-1/2" Rnd Nikl-Brnz Ring & Cover	Bl	1	1	\$120.00
822-CF3ASQ	3" ABS Hub - 5-7/8" Sqr Stnls Steel Ring & Cover	Bl	1	1	\$150.00
822-CF3ASR	3" ABS Hub - 5-1/2" Rnd Stnls Steel Ring & Cover	Bl	1	1	\$120.00
822-CF3PNQ	3" PVC Hub - 5-7/8" Sqr Nikl-Brnz Ring & Cover	Bl	1	1	\$150.00
822-CF3PNR	3" PVC Hub - 5-1/2" Rnd Nikl-Brnz Ring & Cover	Bl	1	1	\$120.00
822-CF3PSQ	3" PVC Hub - 5-7/8" Sqr Stnls Steel Ring & Cover	Bl	1	1	\$150.00
822-CF3PSR	3" PVC Hub - 5-1/2" Rnd Stnls Steel Ring & Cover	Bl	1	1	\$120.00
<b>ACCESSORIES</b>					
822-EX3	Ductile Iron Extension Adapter	B	1	1	\$35.33
832-EX3	Ductile Iron Extension Adapter - 2" Min - 3-3/8" Max	Bl	1	1	\$34.14
832-S3	Two Adjustment Shims, Two 3/4" Screws	Bl	10	10	\$6.10
832-W	Flexible Red Locating Bristles w/ Screw	Bl	10	10	\$7.26



822-CF3PNR

Supply

Drainage

Support

Specialties

Appendix

Supply

Drainage

Support

Specialties

Appendix



851-44N



851-34I

## PVC/ABS - Sch. 40 Hub Connection

**Options:** Add suffix to item no. Add price to list

**V** = Vandal-Resistant Cover: \$6.50; **S** = Stamping: Specify Letters (1): \$12.50;

**C** = Carpet Marker (1): \$16.00;

1: Not available for iron covers.

Item Number	Item Description	Pkg Type	Min Qty	Case Qty	Price
<b>NICKEL-BRONZE COVER</b>					
<b>851-33N</b>	3" ABS Hub - 4-3/8" Rnd Ring & Cover	BI	1	2	\$140.00
851-34N	4" ABS Hub - 6" Rnd Ring & Cover	BI	1	2	\$140.00
<b>851-36N</b>	6" ABS Hub - 8-3/8" Rnd Ring & Cover	BI	1	2	\$350.00
<b>851-43N</b>	3" PVC Hub - 4-3/8" Rnd Ring & Cover	BI	1	2	\$140.00
851-44N	4" PVC Hub - 6" Rnd Ring & Cover	BI	1	2	\$140.00
851-46N	6" PVC Hub - 8-3/8" Rnd Ring & Cover	BI	1	2	\$350.00
<b>TENZ-ALLOY COVER</b>					
<b>851-33T</b>	3" ABS Hub - 4-3/8" Rnd Ring & Cover	BI	1	2	\$110.00
<b>851-34T</b>	4" ABS Hub - 6" Rnd Ring & Cover	BI	1	2	\$110.00
<b>851-36T</b>	6" ABS Hub - 8-3/8" Rnd Ring & Cover	BI	1	2	\$225.00
851-43T	3" PVC Hub - 4-3/8" Rnd Ring & Cover	BI	1	2	\$110.00
851-44T	4" PVC Hub - 6" Rnd Ring & Cover	BI	1	2	\$110.00
851-46T	6" PVC Hub - 8-3/8" Rnd Ring & Cover	BI	1	2	\$225.00
<b>CAST IRON COVER</b>					
851-34I	4" ABS Hub - 6" Rnd Ring & Cover	BI	1	2	\$90.00
<b>851-36I</b>	6" ABS Hub - 8-1/2" Rnd Ring & Cover	BI	1	2	\$175.00
851-44I	4" PVC Hub - 6" Rnd Ring & Cover	BI	1	2	\$90.00
851-46I	6" PVC Hub - 8-1/2" Rnd Ring & Cover	BI	1	2	\$175.00
<b>NB LAMINATED CAST IRON COVER</b>					
<b>851-36IN</b>	6" ABS Hub - 7-1/8" Rnd Ring & Cover	BI	1	2	\$350.00
<b>851-46IN</b>	6" PVC Hub - 7-1/8" Rnd Ring & Cover	BI	1	2	\$350.00

Set Screw Connection

**Options:** Add suffix to item no. Add price to list  
**V** = Vandal-Resistant Cover: \$6.50; **S** = Stamping: Specify Letters (1): \$12.50;  
 1: Not available for iron covers

Item Number	Item Description	Pkg Type	Min Qty	Case Qty	Price
<b>NICKEL-BRONZE</b>					
850-234N	5-1/2" Cover - For 2-3/8" OD to 4-1/2" OD	BI	1	10	\$101.78
850-2N	6-1/2" Cover - For 2" OD to 5" OD	BI	1	6	\$227.16
850-3N	7-1/8" Cover - For 3-3/8" OD to 6-1/2" OD	BI	1	6	\$336.61
<b>850-4N</b>	9-1/8" Cover - For 5-1/2" OD to 8-1/2" OD	BI	1	6	\$446.02
<b>TENZ-ALLOY</b>					
850-2T	6-1/2" Cover - For 2" OD to 5" OD	BI	1	6	\$90.69
850-3T	7-1/8" Cover - For 3-3/8" OD to 6-1/2" OD	BI	1	6	\$115.31
850-4T	9-1/8" Cover - For 5-1/2" OD to 8-1/2" OD	BI	1	6	\$172.64
<b>CAST IRON</b>					
<b>850-2I</b>	6" Cover - For 2-3/8" OD to 5" OD	BI	1	6	\$77.60
850-3I	7" Cover - For 3-3/8" OD to 6-1/4" OD	BI	1	4	\$90.36
850-4I	8-1/2" Cover - For 5" OD to 7-3/4" OD	BI	1	2	\$121.54
<b>NIKL-BRNZ LAMINATED CAST IRON</b>					
850-4IN	8-3/4" Cover - For 5" OD to 7-3/4" OD	BI	1	2	\$492.96



850-234N



850-2T



850-2I

Supply

Drainage

Support

Specialties

Appendix



870-3

### Cleanout Covers

#### Stainless Steel Covers

**Options:** Add suffix to item no. Add price to list  
**S** = Stamping: Specify Letters: \$12.50;

Item Number	Item Description	Pkg Type	Min Qty	Case Qty	Price
<b>20-GA COVER</b>					
870-3	3" Diameter	BI	25	25	\$6.00
870-4	4" Diameter	BI	25	25	\$7.00
870-5	5" Diameter	BI	25	25	\$10.00
870-6	6" Diameter	BI	25	25	\$11.00
870-8	8" Diameter	BI	10	10	\$13.00
870-810	10" Diameter	BI	5	5	\$23.00
870-812	12" Diameter	BI	5	5	\$33.00

### Cleanout Covers

#### ABS Covers



871-4



871-18

Item Number	Item Description	Pkg Type	Min Qty	Case Qty	Price
<b>FLAT COVER</b>					
871-4	White - 4-1/2" Diameter	BI	25	25	\$3.45
871-6	White - 6-1/2" Diameter	BI	25	25	\$6.27
871-8	White - 8-1/2" Diameter	BI	10	10	\$9.86
872-4	Chrome-Plated - 4-1/4" Diameter	BI	25	25	\$10.10
872-6	Chrome-Plated - 7-1/4" Diameter	BI	25	25	\$14.46
872-8	Chrome-Plated - 9-1/4" Diameter	BI	10	10	\$19.18
<b>RAISED COVER</b>					
871-16	White - 7-1/4" Diameter × 1-1/4" Height	BI	25	25	\$15.80
871-18	White - 9-1/4" Diameter × 1-1/4" Height	BI	10	10	\$21.54
872-16	Chrome-Plated - 7-1/4" Diameter × 1-1/4" Height	BI	25	25	\$20.88
872-18	Chrome-Plated - 9-1/4" Diameter × 1-1/4" Height	BI	10	10	\$27.95



Cleanout Cover Kits

Stainless Steel Covers

Options: Add suffix to item no. Add price to list  
 V = Vandal-Resistant Cover Screw (1): \$6.50;

1: For 873 Series only

Item Number	Item Description	Pkg Type	Min Qty	Case Qty	Price
<b>20-GA COVER WITH SCREW</b>					
870-3PK1	3" Cover, 2-1/2" Screw	Bl	5	120	\$8.00
870-4PK1	4" Cover, 2-1/2" Screw	Bl	5	120	\$10.00
870-6PK1	6" Cover, 2-1/2" Screw	Cl	5	80	\$13.00
870-8PK1	8" Cover, 2-1/2" Screw	Bl	5	80	\$16.00
<b>20-GA COVER WITH SCREW AND POLYPRO PLUG</b>					
873-240P	4" Cover, 2" Plug, 2-1/2" Screw	Bl	1	10	\$13.92
873-350P	5" Cover, 3" Plug, 2-1/2" Screw	Bl	1	10	\$18.87
873-460P	6" Cover, 4" Plug, 2-1/2" Screw	Bl	1	10	\$23.18
<b>20-GA COVER WITH SCREW AND WALL BAR</b>					
870-B3	3" Cover, 6" Screw, 9" Wall Bar	Bl	10	10	\$12.31
870-B4	4" Cover, 6" Screw, 9" Wall Bar	Bl	10	10	\$13.06
870-B5	5" Cover, 6" Screw, 9" Wall Bar	Bl	1	10	\$18.28
870-B6	6" Cover, 6" Screw, 9" Wall Bar	Bl	1	10	\$20.50
870-B8	8" Cover, 6" Screw, 9" Wall Bar	Bl	1	10	\$24.98

Cleanout Cover Accessories

Item Number	Item Description	Pkg Type	Min Qty	Case Qty	Price
<b>THREADED WALL BAR</b>					
870-B	1/4" x 20 Threaded Wall Bar, 9" Length	B	25	100	\$3.97
<b>CARPET MARKER KIT</b>					
870-2CM	Stainless Steel Carpet Marker w/ 1-1/2" Screw	Bl	25	25	\$4.39
<b>CLEANOUT COVER SCREW</b>					
874-1	1/4" x 20 Stainless Steel Screw 1-1/2" Length	B	25	1000	\$1.03
874-1C	1/4" x 20 Chrome Plated Screw 1-1/2" Length	B	25	1000	\$1.96
874-1W	1/4" x 20 White Epoxy-Coated Screw 1-1/2" Length	B	25	100	\$3.08
874-2	1/4" x 20 Stainless Steel Screw 2-1/2" Length	B	25	1000	\$1.59
874-2N	1/4" x 20 Nylon Screw 2" Length	B	50	200	\$0.61
874-3C	1/4" x 20 Chrome Plated Screw 3" Length	B	25	500	\$1.90
874-3W	1/4" x 20 White Epoxy-Coated Screw 3" Length	B	25	1000	\$4.31
874-4	1/4" x 20 Stainless Steel Screw 4" Length	B	25	500	\$3.13
874-4C	1/4" x 20 Chrome Plated Screw 4-1/2" Length	B	25	500	\$2.60
874-4W	1/4" x 20 White Epoxy-Coated Screw 4-1/2" Length	B	25	100	\$5.38
874-6	1/4" x 20 Stainless Steel Screw 6" Length	B	25	1000	\$6.27
874-6C	1/4" x 20 Chrome Plated Screw 6" Length	B	25	100	\$3.27
874-6W	1/4" x 20 White Epoxy-Coated Screw 6" Length	B	25	100	\$6.98



870-6PK1



870-B4



870-B



870-2CM



874-1

Supply

Drainage

Support

Specialties

Appendix

Supply

Drainage

Support

Specialties

Appendix



875-3P



875-8230P



875-84PN

### Inside-Pipe Cleanout Bushing

Item Number	Item Description	Pkg Type	Min Qty	Case Qty	Price
<b>BUSHING</b>					
875-2A	2" Black ABS Bushing with 1-1/2" Plug	BI	20	20	\$6.63
875-2P	2" White ABS Bushing with 1-1/2" Plug	BI	20	20	\$6.63
875-3A	3" Black ABS Bushing with 2-1/2" Plug	BI	20	20	\$7.96
875-3P	3" White ABS Bushing with 2-1/2" Plug	BI	20	20	\$7.96
875-4A	4" Black ABS Bushing with 3-1/2" Plug	BI	20	20	\$9.63
875-4P	4" White ABS Bushing with 3-1/2" Plug	BI	20	20	\$9.63
<b>BUSHING WITH 16-GA COVER</b>					
875-8230P	2" White ABS Bushing with 1-1/2" Plug & Stnls Steel Cover	BI	1	10	\$15.50
875-8340P	3" White ABS Bushing with 2-1/2" Plug & Stnls Steel Cover	BI	1	10	\$19.81
875-8450P	4" White ABS Bushing with 3-1/2" Plug & Stnls Steel Cover	BI	1	10	\$21.77

### Inside-Pipe Cleanout Fitting

#### with Nickel-Bronze Cover

Item Number	Item Description	Pkg Type	Min Qty	Case Qty	Price
<b>INSIDE 3" PIPE</b>					
875-83AN	3" ABS Cleanout with Cover	BI	12	12	\$41.98
875-83PN	3" PVC Cleanout with Cover	BI	12	12	\$41.98
<b>INSIDE 4" PIPE</b>					
875-84AN	4" ABS Cleanout with Cover	BI	12	12	\$56.52
875-84PN	4" PVC Cleanout with Cover	BI	12	12	\$56.52

**Polypropylene - Slotted**

Item Number	Item Description	Pkg Type	Min Qty	Case Qty	Price
<b>WITH THREADED BRASS INSERT</b>					
878-15	1-1/2" White	B	25	25	\$2.29
878-15PK	1-1/2" White	CI	25	25	\$2.54
878-20	2" White	B	25	25	\$2.29
878-20PK	2" White	CI	25	25	\$2.54
878-25	2-1/2" White	B	25	25	\$3.01
878-30	3" White	B	25	25	\$3.50
878-30PK	3" White	CI	25	25	\$3.75
878-35	3-1/2" White	B	25	25	\$4.18
878-35PK	3-1/2" White	CI	25	25	\$4.43
878-40	4" White	B	25	25	\$4.86
878-40PK	4" White	CI	25	25	\$5.11
878-50	5" White	B	25	25	\$12.86
878-60	6" White	B	8	8	\$14.60
879-15	1-1/2" Black	B	25	25	\$2.29
879-15PK	1-1/2" Black	CI	25	25	\$2.54
879-20	2" Black	B	25	25	\$2.29
879-20PK	2" Black	CI	25	25	\$2.54
879-25	2-1/2" Black	B	25	25	\$3.01
879-30	3" Black	B	25	25	\$3.50
879-30PK	3" Black	CI	25	25	\$3.75
879-35	3-1/2" Black	B	25	25	\$4.18
879-35PK	3-1/2" Black	CI	25	25	\$4.43
879-40	4" Black	B	25	25	\$4.86
879-40PK	4" Black	CI	25	25	\$5.11
<b>879-50</b>	5" Black	B	20	20	\$12.86
879-60	6" Black	B	8	8	\$14.60
<b>NO INSERT</b>					
878-015	1-1/2" White	B	25	25	\$1.41
878-015PK	1-1/2" White	CI	25	25	\$1.66
878-020	2" White	B	25	25	\$1.53
878-020PK	2" White	B	25	25	\$1.78
878-025	2-1/2" White	B	25	25	\$1.88
878-025PK	2-1/2" White	CI	25	25	\$2.13
878-030	3" White	B	25	25	\$2.11
878-030PK	3" White	CI	25	25	\$2.36
878-035	3-1/2" White	B	25	25	\$2.63
878-035PK	3-1/2" White	CI	25	25	\$2.88
878-040	4" White	B	25	25	\$3.01
878-040PK	4" White	CI	25	25	\$3.26
879-015	1-1/2" Black	B	25	25	\$1.41
879-015PK	1-1/2" Black	CI	25	25	\$1.66
879-020	2" Black	B	25	25	\$1.53
879-020PK	2" Black	CI	25	25	\$1.78
879-025	2-1/2" Black	B	25	25	\$1.88
<b>879-025PK</b>	2-1/2" Black	CI	25	25	\$2.13
879-030	3" Black	B	25	25	\$2.11
879-030PK	3" Black	CI	25	25	\$2.36
879-035	3-1/2" Black	B	25	25	\$2.63
879-035PK	3-1/2" Black	CI	25	25	\$2.88
879-040	4" Black	B	25	25	\$3.01
879-040PK	4" Black	CI	25	25	\$3.26



878-20



878-025

Supply

Drainage

Support

Specialties

Appendix

Supply

Drainage

Support

Specialties

Appendix



878-S30

### Polypropylene - Square-Head

Item Number	Item Description	Pkg Type	Min Qty	Case Qty	Price
878-S15	1-1/2" White	B	25	25	\$1.41
878-S20	2" White	B	25	25	\$1.60
878-S30	3" White	B	25	25	\$2.28
878-S40	4" White	B	25	25	\$3.22
879-S15	1-1/2" Black	B	25	25	\$1.41
879-S20	2" Black	B	25	25	\$1.60
879-S30	3" Black	B	25	25	\$2.28
879-S40	4" Black	B	25	25	\$3.22



878-920

### PVC - Spanner

Item Number	Item Description	Pkg Type	Min Qty	Case Qty	Price
<b>878-915</b>	1-1/2"	B	10	20	\$18.07
878-920	2"	B	10	10	\$18.07
878-930	3"	B	10	10	\$17.58
<b>878-935</b>	3-1/2"	B	10	20	\$18.88
878-940	4"	B	10	10	\$19.41
878-950	5"	B	10	10	\$22.85
878-960	6"	B	10	10	\$29.45
878-980	8"	B	10	10	\$48.88

## Replacement Cleanout Covers

### Nickel Bronze Covers

**Options:** Add suffix to item no. Add price to list  
**B** = Beveled Edge for Floor Plate (1): \$10.00;

1: For 851 Series covers

Item Number	Item Description	Pkg Type	Min Qty	Case Qty	Price
<b>FOR 834 &amp; 852 SERIES</b>					
852-CN2	4" Rnd Cover	BI	1	10	\$48.94
852-CN3	5-1/16" Rnd Cover	BI	1	10	\$52.68
852-CN4	6-1/8" Rnd Cover	BI	1	10	\$71.49
852-HCN4	6-1/8" Rnd Cover - Special-Duty	BI	1	1	\$100.83
<b>FOR 851 SERIES</b>					
851-CN3	5-1/4" Rnd Cover	BI	1	10	\$84.42
851-CN4	6-1/8" Rnd Cover	BI	1	10	\$121.13
851-CN6	7-3/4" Rnd Cover	BI	1	10	\$135.82
851-CN8	8-3/8" Rnd Cover	BI	1	10	\$172.48
<b>FOR 850 SERIES</b>					
850-CN2	6-1/16" Rnd Cover	BI	1	10	\$83.12
850-CN3	6-3/8" Rnd Cover	BI	1	10	\$114.79
850-CN4	8-3/8" Rnd Cover	BI	1	1	\$197.91



852-CN2

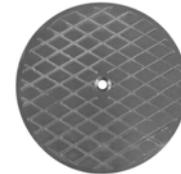

851-CN3



850-CN2

## Replacement Cleanout Covers

### Tenz-Alloy Covers

**Options:** Add suffix to item no. Add price to list  
**B** = Beveled Edge for Floor Plate (1): \$10.00;

1: For 851 Series covers

Item Number	Item Description	Pkg Type	Min Qty	Case Qty	Price
<b>FOR 834 &amp; 852 SERIES</b>					
852-CT4	6-1/8" Rnd Cover	BI	1	2	\$35.37
<b>FOR 851 SERIES</b>					
851-CT3	5-1/4" Rnd Cover	BI	1	10	\$39.42
851-CT4	6-1/8" Rnd Cover	BI	1	10	\$50.18
851-CT6	7-3/4" Rnd Cover	BI	1	10	\$60.94
851-CT8	8-3/8" Rnd Cover	BI	1	10	\$78.88
<b>FOR 850 SERIES</b>					
850-CT2	6-1/16" Rnd Cover	BI	1	10	\$34.81
850-CT3	6-3/8" Rnd Cover	BI	1	10	\$56.89
850-CT4	8-3/8" Rnd Cover	BI	1	10	\$89.83



852-CT4

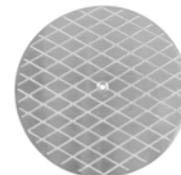

851-CT3

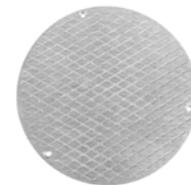

850-CT2

Supply

Drainage

Support

Specialties

Appendix



852-CD4

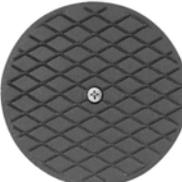

851-CI3



850-CI3



852-CS3

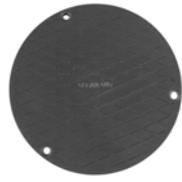

852-CP3

## Replacement Cleanout Covers

### Cast Iron Covers

Item Number	Item Description	Pkg Type	Min Qty	Case Qty	Price
<b>FOR 834 &amp; 852 SERIES</b>					
852-CD4	6-1/8" Rnd Cover	BI	1	10	\$22.03
<b>852-CI3</b>	5-1/16" Rnd Cover	BI	1	1	\$27.54
852-CI4	6-1/16" Rnd Cover	BI	1	5	\$43.28
852-HCD4	6-1/8" Rnd Cover - Special-Duty	BI	1	1	\$28.88
<b>FOR 851 SERIES</b>					
851-CI4	5-1/8" Rnd Cover	BI	1	1	\$26.23
851-CI6	6-1/8" Rnd Cover	BI	1	10	\$37.50
851-CI8	7-3/4" Rnd Cover	BI	1	10	\$44.98
<b>FOR 850 SERIES</b>					
<b>850-CI2</b>	5-1/8" Rnd Cover	BI	1	1	\$27.90
850-CI3	6-3/16" Rnd Cover	BI	1	1	\$44.47
<b>850-CI4</b>	7-3/4" Rnd Cover	BI	1	1	\$52.54

## Replacement Cleanout Covers

### Stainless Steel Covers

Item Number	Item Description	Pkg Type	Min Qty	Case Qty	Price
<b>FOR 834 &amp; 852 SERIES</b>					
<b>852-CS3</b>	5-1/8" Rnd Cover	BI	1	1	\$52.68
<b>852-CS4</b>	6-1/8" Rnd Cover	BI	1	1	\$71.49

## Replacement Cleanout Covers

### Gray ABS Covers

Item Number	Item Description	Pkg Type	Min Qty	Case Qty	Price
<b>FOR 834 &amp; 852 SERIES</b>					
<b>852-CP3</b>	5-1/16" Rnd Cover	BI	1	1	\$15.06
<b>852-CP4</b>	6-1/8" Rnd Cover	BI	1	1	\$17.69

# **Trench Drains**

**FastTrack™ System**

**HydroTec™ System**

**HydroBlock™ System**

**HydroLine™ System**

# Trench Drains

## FastTrack™ System

Sloped and neutral channels made from engineered high-density polyethylene. DIN EN load ratings from A15 to D400. Designed in accordance with ASME A112.6.3 Standard for Floor and Trench Drains.

## HydroTec™ System

Sloped and neutral channels constructed from reinforced concrete with integral edge rails. DIN EN load ratings up to F900. Designed in accordance with ASME A112.6.3 Standard for Floor and Trench Drains.

## HydroBlock™ System

One-piece ductile iron channel and grate system designed for heavy loads and high-traffic areas. DIN EN load rating up to F900.

## HydroLine™ System

Low-profile, one-piece channels made from ductile iron or aluminum lock into concrete slab for heavy-duty traffic. DIN EN load rating up to F900



# FastTrack™ System

**Pre-Sloped System**

**Large-Capacity System**

FastTrack™ channels are tough, lightweight, and chemical-resistant. Channels include integral rebar clips, grate anchors and bottom outlet.

Multiple grate options available for applications from pedestrian traffic to heavy-duty loads.

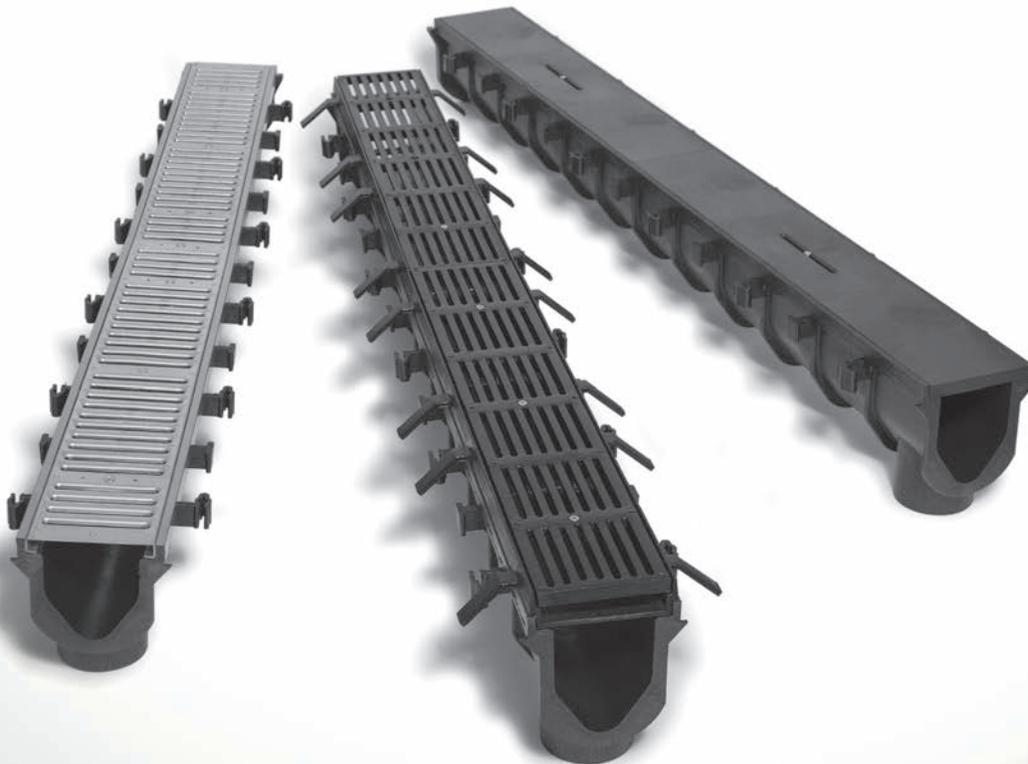



**FastTrack™ Pre-Sloped System**

Item Number	Item Description	Pkg Type	Min Qty	Case Qty	Price
<b>CHANNELS</b>					
865-N3	Neutral Channel w/ Construction Cover - 72" Long	B	1	1	\$260.92
865-N5	Neutral Channel w/ Construction Cover- 72" Long	B	1	1	\$260.92
865-N7	Neutral Channel w/ Construction Cover- 72" Long	B	1	1	\$260.92
865-N9	Neutral Channel w/ Construction Cover- 72" Long	B	1	1	\$260.92
865-S1	Sloped Channel w/ Construction Cover- 72" Long	B	1	1	\$260.92
865-S2	Sloped Channel w/ Construction Cover- 72" Long	B	1	1	\$260.92
865-S3	Sloped Channel w/ Construction Cover- 72" Long	B	1	1	\$260.92
865-S4	Sloped Channel w/ Construction Cover- 72" Long	B	1	1	\$260.92
865-S5	Sloped Channel w/ Construction Cover- 72" Long	B	1	1	\$260.92
865-S6	Sloped Channel w/ Construction Cover- 72" Long	B	1	1	\$260.92
865-S7	Sloped Channel w/ Construction Cover- 72" Long	B	1	1	\$260.92
865-S8	Sloped Channel w/ Construction Cover- 72" Long	B	1	1	\$260.92
865-S9	Sloped Channel w/ Construction Cover- 72" Long	B	1	1	\$260.92
<b>DUCTILE IRON GRATES</b>					
865-GIC	Cross-Slot Ductile Iron Grate w/ Screws - Class C - 36" Long	BI	1	1	\$271.72
865-GID	Diagonal-Slot Ductile Iron Grate w/ Screws - Class C - 36" Long	BI	1	1	\$271.72
865-GIS	Slotted Ductile Iron Grate w/ Screws - Class D - 36" Long	BI	1	1	\$257.02
<b>STAINLESS STEEL GRATES</b>					
865-GSA	Angle-Slot Grate w/ Screws - Class A - 36" Long	BI	1	1	\$220.31
865-GSB	Brick Slot Stainless Steel Grate w/ Screws - Class C - 36" Long	BI	1	2	\$547.51
865-GSBC	Stainless Steel Access Section for Brick Slot Grate - Class C - 12" Long	B	1	1	\$778.00
865-GSD	Perforated Stainless Steel Grate w/ Screws - Class A - 36" Long	BI	1	1	\$227.66
865-GSS	Slotted Stainless Steel Grate w/ Screws - Class A - 36" Long	BI	1	1	\$223.64
865-GSSR	Reinforced Slotted Stainless Steel Grate w/ Screws - Class C - 36" Long	BI	1	1	\$316.16
<b>GALVANIZED STEEL GRATES</b>					
865-GGD	Perforated Galvanized Steel Grate w/ Screws - Class A - 36" Long	BI	1	1	\$198.29
865-GGS	Slotted Galvanized Steel Grate w/ Screws - Class A - 36" Long	BI	1	1	\$175.63
865-GGSR	Reinforced Slotted Galvanized Steel Grate w/ Screws - Class C - 36" Long	BI	1	1	\$259.92
<b>POLYMER GRATES</b>					
865-GHC	Cross-Slot GFPP Grate w/ Screws - Class A - 36" Long	BI	1	1	\$169.98
865-GHS	Slotted HDPE Grate w/ Screws - Class A - 36" Long	BI	1	2	\$146.87



865-S3



865-GIS



865-GSA



865-GGS



865-GHC

Supply

Drainage

Support

Specialties

Appendix



865-F

### FastTrack™ Pre-Sloped System (Cont)

Item Number	Item Description	Pkg Type	Min Qty	Case Qty	Price
<b>ACCESSORIES</b>					
865-A	Grate Anchor - Stainless – Fits All Channels	B	1	20	\$6.54
<b>865-C</b>	Construction Cover - HDPE 36" Long - Fits All FastTrack Channels	B	1	1	\$16.73
865-CB4	4" Outlet Adapter for Catch Basin - Fits 3" & 4" Sch. 40, 4" SDR35 pipe	BI	1	1	\$42.40
865-CB6	6" Outlet Adapter for Catch Basin - Fits 6" SDR35 pipe	BI	1	1	\$42.40
865-D	Dome Bottom Strainer - Stainless Steel – For Bottom Outlet	BI	1	1	\$36.85
865-EC	End Cap - HDPE Flat Cap – Fits All Channels	BI	1	50	\$29.79
865-EG	SS Edge Guards w/Screws, 36" Long, 2/Box	BI	1	1	\$119.07
865-EO	End Outlet - HDPE w/ 4" No-Hub Connection	BI	1	25	\$29.79
865-F	Ductile Iron Grate Frame - 36" Long w/ Screws	BI	1	1	\$168.90
<b>865-FB</b>	Debris Basket - Fits FastTrack Catch Basin	BI	1	1	\$268.18
<b>865-FC</b>	Catch Basin - 36" Long - Fits All FastTrack Channels	BI	1	1	\$283.02
865-FCB	Catch Basin w/Basket - 36" Long - Fits All FastTrack Channels	BI	1	1	\$551.20
865-S15	Screws For FastTrack Grate, 1-1/2", 3/Bag	BI	1	100	\$5.41

### FastTrack™ Large-Capacity System

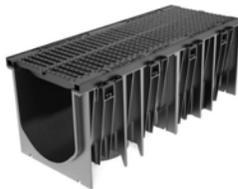

865-TNDS



865-TNCBDS

Item Number	Item Description	Pkg Type	Min Qty	Case Qty	Price
<b>CHANNEL &amp; GRATE UNITS</b>					
865-TNDS	Neutral Channel Section w/ Slotted Class D Grate - One-Meter Long	B	1	1	\$756.00
865-TNFM	Neutral Channel Section w/ Mesh Class F Grate - One-Meter Long	B	1	1	\$1,045.00
<b>ACCESSORIES</b>					
865-TEC	End Cap - PVC flat cap	B	1	1	\$44.45
865-TEO	End Outlet - PVC with 8" Connection	B	1	1	\$110.00
865-TNB	Removable Debris Basket for Catch Basin - Stainless Steel	B	1	1	\$496.00
865-TNCBDS	Catch Basin w/ Slotted Class D Grate - Half-Meter Long	B	1	1	\$1,789.00
865-TNCBFM	Catch Basin w/ Mesh Class F Grate - Half-Meter Long	B	1	1	\$1,937.00

### FastTrack™ Low-Profile System



865-NS1

Item Number	Item Description	Pkg Type	Min Qty	Case Qty	Price
<b>CHANNELS</b>					
865-NS1	Shallow Neutral Channel w/ Construction Cover- 36" Long	BI	1	1	\$87.50
<b>DUCTILE IRON GRATES</b>					
865-GIC	Cross-Slot Ductile Iron Grate w/ Screws - Class C - 36" Long	BI	1	1	\$271.72
865-GID	Diagonal-Slot Ductile Iron Grate w/ Screws - Class C - 36" Long	BI	1	1	\$271.72
865-GIS	Slotted Ductile Iron Grate w/ Screws - Class D - 36" Long	BI	1	1	\$257.02

**FastTrack™ Low-Profile System (Cont)**

Item Number	Item Description	Pkg Type	Min Qty	Case Qty	Price
<b>STAINLESS STEEL GRATES</b>					
865-GSA	Angle-Slot Grate w/ Screws - Class A - 36" Long	BI	1	1	\$220.31
865-GSB	Brick Slot Stainless Steel Grate w/ Screws - Class C - 36" Long	BI	1	2	\$547.51
865-GSBC	Stainless Steel Access Section for Brick Slot Grate - Class C - 12" Long	B	1	1	\$778.00
865-GSD	Perforated Stainless Steel Grate w/ Screws - Class A - 36" Long	BI	1	1	\$227.66
865-GSS	Slotted Stainless Steel Grate w/ Screws - Class A - 36" Long	BI	1	1	\$223.64
865-GSSR	Reinforced Slotted Stainless Steel Grate w/ Screws - Class C - 36" Long	BI	1	1	\$316.16
<b>GALVANIZED STEEL GRATES</b>					
865-GGD	Perforated Galvanized Steel Grate w/ Screws - Class A - 36" Long	BI	1	1	\$198.29
865-GGS	Slotted Galvanized Steel Grate w/ Screws - Class A - 36" Long	BI	1	1	\$175.63
865-GGSR	Reinforced Slotted Galvanized Steel Grate w/ Screws - Class C - 36" Long	BI	1	1	\$259.92
<b>POLYMER GRATES</b>					
865-GHC	Cross-Slot GFPP Grate w/ Screws - Class A - 36" Long	BI	1	1	\$169.98
865-GHS	Slotted HDPE Grate w/ Screws - Class A - 36" Long	BI	1	2	\$146.87
<b>ACCESSORIES</b>					
865-A	Grate Anchor - Stainless – Fits All Channels	B	1	20	\$6.54
<b>865-C</b>	Construction Cover - HDPE 36" Long - Fits All FastTrack Channels	B	1	1	\$16.73
865-EG	SS Edge Guards w/Screws, 36" Long, 2/Box	BI	1	1	\$119.07
865-F	Ductile Iron Grate Frame - 36" Long w/ Screws	BI	1	1	\$168.90
865-NSC		BI	1	50	\$5.25
865-S15	Screws For FastTrack Grate, 1-1/2", 3/Bag	BI	1	100	\$5.41



865-GSA



865-GHC



865-F

Supply

Drainage

Support

Specialties

Appendix



# HydroTec™ System

HydroTec™ Maxi

HydroTec™ Top

HydroTec™ trench drain systems are constructed from fiber-reinforced concrete channels with integral ductile iron (Maxi system) or galvanized steel (Top system) edge rails. Grates are available with bolt-less locking feature or 'F1' locking option.

Highly stable and suitable for a variety of applications, with load ratings up to F900.

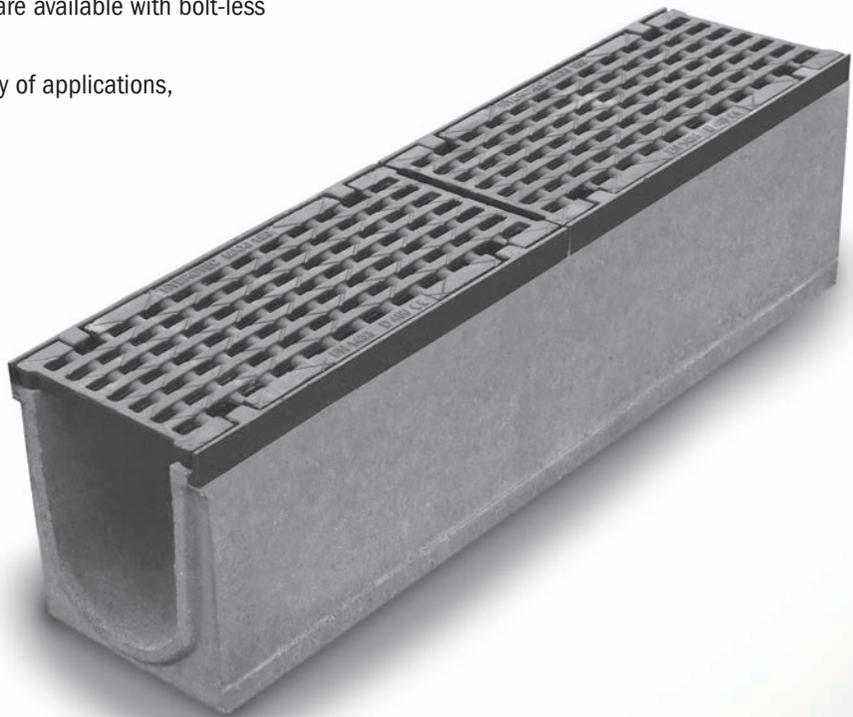



**865-M4N10**  
Page 393



**865-M6S01DA**  
Page 395



**865-M6S01FA**  
Page 396



**865-M8N00DA**  
Page 397



**865-M12PN00EA**  
Page 397



**865-M16PN00EA**  
Page 398



**865-T4N10**  
Page 399

 <b>865-M16PN00EA</b> Page 398	 <b>865-T4N10</b> Page 399			



**HydroTec™ MAXI System**

**Maxi 100 - 4" Wide**



865-M4DICH

Item Number	Item Description	Pkg Type	Min Qty	Case Qty	Price
<b>GRATES</b>					
865-M4DICH	Half-Meter, Class C, Ductile Iron, Heel Proof Slot	B	1	1	\$74.17
865-M4DICT	Half-Meter, Class C, Ductile Iron, Transverse Slot	B	1	1	\$57.61
865-M4DIDL	Half-Meter, Class D, Ductile Iron, Long Slot, ADA	B	1	1	\$77.18
865-M4DIEM	Half-Meter, Class E, Ductile Iron, Mesh	B	1	1	\$104.72
865-M4DIFH	Half-Meter, Class F, Ductile Iron, Heel Proof Slot	B	1	1	\$118.36
865-M4DIFL	Half-Meter, Class F, Ductile Iron, Long Slot, ADA	B	1	1	\$129.98
<b>CHANNELS</b>					
865-M4N10	One-Meter, 4" Wide × 6.30" Height, Neutral	B	1	1	\$188.96
865-M4N105	Half-Meter, 4" Wide × 6.30" Height, Neutral	B	1	1	\$166.17
865-M4N105S	Half-Meter, 4" Wide × 6.30" Height, Neutral, Side Out	B	1	1	\$193.53
865-M4N10B	One-Meter, 4" Wide × 6.30" Height, Neutral, Bottom Out	B	1	1	\$239.35
865-M4N15	One-Meter, 4" Wide × 7.28" Height, Neutral	B	1	1	\$188.96
865-M4N155	Half-Meter, 4" Wide × 7.28" Height, Neutral	B	1	1	\$166.17
865-M4N155S	Half-Meter, 4" Wide × 7.28" Height, Neutral, Side Out	B	1	1	\$193.53
865-M4N15B	One-Meter, 4" Wide × 7.28" Height, Neutral, Bottom Out	B	1	1	\$239.35
865-M4N20	One-Meter, 4" Wide × 8.27" Height, Neutral	B	1	1	\$188.96
865-M4N205	Half-Meter, 4" Wide × 8.27" Height, Neutral	B	1	1	\$166.17
865-M4N205S	Half-Meter, 4" Wide × 8.27" Height, Neutral, Side Out	B	1	1	\$193.53
865-M4N20B	One-Meter, 4" Wide × 8.27" Height, Neutral, Bottom Out	B	1	1	\$239.35
865-M4N25	One-Meter, 4" Wide × 9.25" Height, Neutral	B	1	1	\$188.96
865-M4N255	Half-Meter, 4" Wide × 9.25" Height, Neutral	B	1	1	\$166.17
865-M4N255S	Half-Meter, 4" Wide × 9.25" Height, Neutral, Side Out	B	1	1	\$193.53
865-M4N25B	One-Meter, 4" Wide × 9.25" Height, Neutral, Bottom Out	B	1	1	\$239.35
865-M4N30	One-Meter, 4" Wide × 10.2" Height, Neutral	B	1	1	\$188.96
865-M4N305	Half-Meter, 4" Wide × 10.2" Height, Neutral	B	1	1	\$166.17
865-M4N305S	Half-Meter, 4" Wide × 10.2" Height, Neutral, Side Out	B	1	1	\$193.53
865-M4N30B	One-Meter, 4" Wide × 10.2" Height, Neutral, Bottom Out	B	1	1	\$239.35
865-M4S01	One-Meter, 4" Wide, Slope # 1	B	1	1	\$188.96
865-M4S02	One-Meter, 4" Wide, Slope # 2	B	1	1	\$188.96
865-M4S03	One-Meter, 4" Wide, Slope # 3	B	1	1	\$188.96
865-M4S04	One-Meter, 4" Wide, Slope # 4	B	1	1	\$188.96
865-M4S05	One-Meter, 4" Wide, Slope # 5	B	1	1	\$188.96
865-M4S06	One-Meter, 4" Wide, Slope # 6	B	1	1	\$188.96
865-M4S07	One-Meter, 4" Wide, Slope # 7	B	1	1	\$188.96
865-M4S08	One-Meter, 4" Wide, Slope # 8	B	1	1	\$188.96
865-M4S09	One-Meter, 4" Wide, Slope # 9	B	1	1	\$188.96
865-M4S10	One-Meter, 4" Wide, Slope # 10	B	1	1	\$188.96
865-M4S11	One-Meter, 4" Wide, Slope # 11	B	1	1	\$188.96
865-M4S12	One-Meter, 4" Wide, Slope # 12	B	1	1	\$188.96
865-M4S13	One-Meter, 4" Wide, Slope # 13	B	1	1	\$188.96
865-M4S14	One-Meter, 4" Wide, Slope # 14	B	1	1	\$188.96
865-M4S15	One-Meter, 4" Wide, Slope # 15	B	1	1	\$188.96
865-M4S16	One-Meter, 4" Wide, Slope # 16	B	1	1	\$188.96

Supply

Drainage

Support

Specialties

Appendix

**HydroTec™ MAXI System (Cont)**

**Maxi 100 - 4" Wide**

Item Number	Item Description	Pkg Type	Min Qty	Case Qty	Price
<b>CHANNELS</b>					
865-M4S17	One-Meter, 4" Wide, Slope # 17	B	1	1	\$188.96
865-M4S18	One-Meter, 4" Wide, Slope # 18	B	1	1	\$188.96
865-M4S19	One-Meter, 4" Wide, Slope # 19	B	1	1	\$188.96
865-M4S20	One-Meter, 4" Wide, Slope # 20	B	1	1	\$188.96
865-M4S21	One-Meter, 4" Wide, Slope # 21	B	1	1	\$188.96
865-M4S22	One-Meter, 4" Wide, Slope # 22	B	1	1	\$188.96
865-M4S23	One-Meter, 4" Wide, Slope # 23	B	1	1	\$188.96
865-M4S24	One-Meter, 4" Wide, Slope # 24	B	1	1	\$188.96
865-M4S25	One-Meter, 4" Wide, Slope # 25	B	1	1	\$188.96
865-M4S26	One-Meter, 4" Wide, Slope # 26	B	1	1	\$188.96
865-M4S27	One-Meter, 4" Wide, Slope # 27	B	1	1	\$188.96
865-M4S28	One-Meter, 4" Wide, Slope # 28	B	1	1	\$188.96
865-M4S29	One-Meter, 4" Wide, Slope # 29	B	1	1	\$188.96
865-M4S30	One-Meter, 4" Wide, Slope # 30	B	1	1	\$188.96
<b>LOW-PROFILE CHANNELS</b>					
865-M4LP00	One-Meter, 4" Wide × 3.15" Height, Neutral	B	1	1	\$188.96
865-M4LP005	Half-Meter, 4" Wide × 3.15" Height, Neutral	B	1	1	\$166.17
865-M4LP00B	One-Meter, 4" Wide × 3.15" Height, Neutral, Bottom Out	B	1	1	\$239.35
865-M4N00	One-Meter, 4" Wide × 4.33" Height, Neutral	B	1	1	\$188.96
865-M4N005	Half-Meter, 4" Wide × 4.33" Height, Neutral	B	1	1	\$166.17
865-M4N00B	One-Meter, 4" Wide × 4.33" Height, Neutral, Bottom Out	B	1	1	\$239.35
<b>CATCH BASIN</b>					
865-M4CB	Half-Meter, Catch Basin w/ Galv Steel Debris Basket - 6" Outlet	B	1	1	\$369.54
<b>ACCESSORIES</b>					
865-4BK	Installation Bracket for Maxi/Top 100 Channels	B	1	1	\$44.50
865-4EC	4" Closed End Cap - 2 Piece	B	1	1	\$40.92
865-4LPEC3	4" Closed End Cap For 3.15" Channel	B	1	1	\$29.65
865-4LPEC4	4" Closed End Cap For 4.33" Channel	B	1	1	\$29.65
865-4LR	Grate-Locking Rod For 4" Channels	B	1	1	\$1.73
865-4OC	4" Open End Cap - 2 Piece	B	1	1	\$40.92
865-4PC	4" PVC S&D Pipe Connection	B	1	1	\$14.82
865-4RS	4" Rubber Sleeve / Seal For Bottom Outs	B	1	1	\$54.44
865-SHOVEL	Cleaning Shovel For Mini/Top/Maxi	B	1	1	\$203.49
865-TOOL	Grate-Locking Tool	B	1	1	\$39.14



865-M4N10



865-M4LP00



865-M4CB



865-TOOL

Supply

Drainage

Support

Specialties

Appendix

HydroTec™ MAXI System

Maxi 150 - 6" Wide



865-M6S01DA

Item Number	Item Description	Pkg Type	Min Qty	Case Qty	Price
<b>CHANNELS - CLASS D GRATE</b>					
865-M6CBDA	Half-Meter, Catch Basin w/ Galv Basket And Class D Ductile Iron ADA Grate - 6" Outlet	B	1	1	\$897.22
865-M6N005DA	Half-Meter, 6" Wide x 8.27" Height, Neutral w/ Class D ADA Ductile Iron Grate	B	1	1	\$318.58
865-M6N005SDA	Half-Meter, 6" Wide x 8.27" Height, Neutral, Side Out w/ Class D ADA Ductile Iron Grate	B	1	1	\$371.81
865-M6N00BDA	One-Meter, 6" Wide x 8.27" Height, Neutral, Bottom Out w/ Class D ADA Ductile Iron Grate	B	1	1	\$647.10
865-M6N00DA	One-Meter, 6" Wide x 8.27" Height, Neutral w/ Class D ADA Ductile Iron Grate	B	1	1	\$523.38
865-M6N055DA	Half-Meter, 6" Wide x 10.24" Height, Neutral w/ Class D ADA Ductile Iron Grate	B	1	1	\$318.58
865-M6N055SDA	Half-Meter, 6" Wide x 10.24" Height, Neutral, Side Out w/ Class D ADA Ductile Iron Grate	B	1	1	\$371.81
865-M6N05BDA	One-Meter, 6" Wide x 10.24" Height, Neutral, Bottom Out w/ Class D ADA Ductile Iron Grate	B	1	1	\$647.10
865-M6N05DA	One-Meter, 6" Wide x 10.24" Height, Neutral w/ Class D ADA Ductile Iron Grate	B	1	1	\$523.38
865-M6N105DA	Half-Meter, 6" Wide x 12.20" Height, Neutral w/ Class D ADA Ductile Iron Grate	B	1	1	\$318.58
865-M6N105SDA	Half-Meter, 6" Wide x 12.20" Height, Neutral, Side Out w/ Class D ADA Ductile Iron Grate	B	1	1	\$371.81
865-M6N10BDA	One-Meter, 6" Wide x 12.20" Height, Neutral, Bottom Out w/ Class D ADA Ductile Iron Grate	B	1	1	\$647.10
865-M6N10DA	One-Meter, 6" Wide x 12.20" Height, Neutral w/ Class D ADA Ductile Iron Grate	B	1	1	\$523.38
865-M6S01DA	One-Meter, 6" Wide, Slope # 1 w/ Class D ADA Ductile Iron Grate	B	1	1	\$523.38
865-M6S02DA	One-Meter, 6" Wide, Slope # 2 w/ Class D ADA Ductile Iron Grate	B	1	1	\$523.38
865-M6S03DA	One-Meter, 6" Wide, Slope # 3 w/ Class D ADA Ductile Iron Grate	B	1	1	\$523.38
865-M6S04DA	One-Meter, 6" Wide, Slope # 4 w/ Class D ADA Ductile Iron Grate	B	1	1	\$523.38
865-M6S05DA	One-Meter, 6" Wide, Slope # 5 w/ Class D ADA Ductile Iron Grate	B	1	1	\$523.38
865-M6S06DA	One-Meter, 6" Wide, Slope # 6 w/ Class D ADA Ductile Iron Grate	B	1	1	\$523.38
865-M6S07DA	One-Meter, 6" Wide, Slope # 7 w/ Class D ADA Ductile Iron Grate	B	1	1	\$523.38
865-M6S08DA	One-Meter, 6" Wide, Slope # 8 w/ Class D ADA Ductile Iron Grate	B	1	1	\$523.38
865-M6S09DA	One-Meter, 6" Wide, Slope # 9 w/ Class D ADA Ductile Iron Grate	B	1	1	\$523.38
865-M6S10DA	One-Meter, 6" Wide, Slope # 10 w/ Class D ADA Ductile Iron Grate	B	1	1	\$523.38
<b>CHANNELS - CLASS F GRATE</b>					
865-M6CBFA	Half-Meter, Catch Basin w/ Galv Basket And Class F ADA Ductile Iron Grate - 6" Outlet	B	1	1	\$946.60
865-M6N005FA	Half-Meter, 6" Wide x 8.27" Height, Neutral w/ Class F ADA Ductile Iron Grate	B	1	1	\$367.62
865-M6N005SFA	Half-Meter, 6" Wide x 8.27" Height, Neutral, Side Out w/ Class F ADA Ductile Iron Grate	B	1	1	\$423.19
865-M6N00BFA	One-Meter, 6" Wide x 8.27" Height, Neutral, Bottom Out w/ Class F ADA Ductile Iron Grate	B	1	1	\$725.86
865-M6N00FA	One-Meter, 6" Wide x 8.27" Height, Neutral w/ Class F ADA Ductile Iron Grate	B	1	1	\$589.89
865-M6N055FA	Half-Meter, 6" Wide x 10.24" Height, Neutral w/ Class F ADA Ductile Iron Grate	B	1	1	\$367.62

Supply

Drainage

Support

Specialties

Appendix

## HydroTec™ MAXI System (Cont)

### Maxi 150 - 6" Wide

Item Number	Item Description	Pkg Type	Min Qty	Case Qty	Price
<b>CHANNELS - CLASS F GRATE</b>					
865-M6N055SFA	Half-Meter, 6" Wide × 10.24" Height, Neutral, Side Out w/ Class F ADA Ductile Iron Grate	B	1	1	\$423.19
865-M6N05BFA	One-Meter, 6" Wide × 10.24" Height, Neutral, Bottom Out w/ Class F ADA Ductile Iron Grate	B	1	1	\$712.29
865-M6N05FA	One-Meter, 6" Wide × 10.24" Height, Neutral w/ Class F ADA Ductile Iron Grate	B	1	1	\$589.89
865-M6N105FA	Half-Meter, 6" Wide × 12.20" Height, Neutral w/ Class F ADA Ductile Iron Grate	B	1	1	\$367.62
865-M6N105SFA	Half-Meter, 6" Wide × 12.20" Height, Neutral, Side Out w/ Class F ADA Ductile Iron Grate	B	1	1	\$423.19
865-M6N10BFA	One-Meter, 6" Wide × 12.20" Height, Neutral, Bottom Out w/ Class F ADA Ductile Iron Grate	B	1	1	\$712.29
865-M6N10FA	One-Meter, 6" Wide × 12.20" Height, Neutral w/ Class F ADA Ductile Iron Grate	B	1	1	\$589.89
865-M6S01FA	One-Meter, 6" Wide, Slope # 1 w/ Class F ADA Ductile Iron Grate	B	1	1	\$589.89
865-M6S02FA	One-Meter, 6" Wide, Slope # 2 w/ Class F ADA Ductile Iron Grate	B	1	1	\$589.89
865-M6S03FA	One-Meter, 6" Wide, Slope # 3 w/ Class F ADA Ductile Iron Grate	B	1	1	\$589.89
865-M6S04FA	One-Meter, 6" Wide, Slope # 4 w/ Class F ADA Ductile Iron Grate	B	1	1	\$589.89
865-M6S05FA	One-Meter, 6" Wide, Slope # 5 w/ Class F ADA Ductile Iron Grate	B	1	1	\$589.89
865-M6S06FA	One-Meter, 6" Wide, Slope # 6 w/ Class F ADA Ductile Iron Grate	B	1	1	\$589.89
865-M6S07FA	One-Meter, 6" Wide, Slope # 7 w/ Class F ADA Ductile Iron Grate	B	1	1	\$589.89
865-M6S08FA	One-Meter, 6" Wide, Slope # 8 w/ Class F ADA Ductile Iron Grate	B	1	1	\$589.89
865-M6S09FA	One-Meter, 6" Wide, Slope # 9 w/ Class F ADA Ductile Iron Grate	B	1	1	\$589.89
865-M6S10FA	One-Meter, 6" Wide, Slope # 10 w/ Class F ADA Ductile Iron Grate	B	1	1	\$589.89
<b>CHANNELS - CLASS F GRATE WITH F1-LOCKING FEATURE</b>					
865-M6CBF1A	Half-Meter, Catch Basin w/ Galv Basket And F1 Class F ADA Grate - 6" Outlet	B	1	1	\$978.97
865-M6N005F1A	Half-Meter, 6" Wide × 8.27" Height, Neutral w/ F1 Class F ADA Ductile Iron Grate	B	1	1	\$400.01
865-M6N005SF1A	Half-Meter, 6" Wide × 8.27" Height, Neutral, Side Out w/ F1 Class F ADA Ductile Iron Grate	B	1	1	\$455.52
865-M6N00BF1A	One-Meter, 6" Wide × 8.27" Height, Neutral, Bottom Out w/ F1 Class F ADA Ductile Iron Grate	B	1	1	\$777.01
865-M6N00F1A	One-Meter, 6" Wide × 8.27" Height, Neutral w/ F1 Class F ADA Ductile Iron Grate	B	1	1	\$654.64
<b>ACCESSORIES</b>					
865-6LR	Grate-Locking Rod For 6" Channels	B	1	1	\$2.32
865-6PC	PVC S&D Pipe Connection for 6" Outs	B	1	1	\$27.26
865-6PCE	6" Oval PVC Pipe Connection	B	1	1	\$45.05
865-6RS	Rubber Sleeve/Seal For 6" Bottom Outs	B	1	1	\$65.21
865-6UC	6" Universal End Cap - Open & Closed	BI	1	20	\$49.53
865-SHOVEL	Cleaning Shovel For Mini/Top/Maxi	B	1	1	\$203.49
865-TOOL	Grate-Locking Tool	B	1	1	\$39.14



865-M6S01FA



865-6UC

Supply

Drainage

Support

Specialties

Appendix

**HydroTec™ MAXI System**

**Maxi 200 - 8" Wide**

Item Number	Item Description	Pkg Type	Min Qty	Case Qty	Price
<b>CHANNELS - CLASS D GRATE</b>					
865-M8CBDA	Half-Meter, Catch Basin w/ Galv Basket And Class D ADA Ductile Iron Grate - 6" Outlet	B	1	1	\$883.97
865-M8N005DA	Half-Meter, 8" Wide × 12.20" Height w/ Class D ADA Ductile Iron Grate	B	1	1	\$416.74
865-M8N005SDA	Half-Meter, 8" Wide × 12.20" Height, Side Out w/ Class D ADA Ductile Iron Grate	B	1	1	\$462.67
865-M8N00BDA	One-Meter, 8" Wide × 12.20" Height, Bottom Out w/ Class D ADA Ductile Iron Grate	B	1	1	\$768.42
865-M8N00DA	One-Meter, 8" Wide × 12.20" Height w/ Class D ADA Ductile Iron Grate	B	1	1	\$690.65
<b>CHANNELS - CLASS F GRATE</b>					
865-M8CBFA	Half-Meter, Catch Basin w/ Galv Basket And Class F ADA Ductile Iron Grate - 6" Outlet	B	1	1	\$935.00
865-M8N005FA	Half-Meter, 8" Wide × 12.20" Height w/ Class F ADA Ductile Iron Grate	B	1	1	\$457.10
865-M8N005SFA	Half-Meter, 8" Wide × 12.20" Height, Side Out w/ Class F ADA Ductile Iron Grate	B	1	1	\$512.43
865-M8N00BFA	One-Meter, 8" Wide × 12.20" Height, Bottom Out w/ Class F ADA Ductile Iron Grate	B	1	1	\$837.15
865-M8N00FA	One-Meter, 8" Wide × 12.20" Height w/ Class F ADA Ductile Iron Grate	B	1	1	\$762.09
<b>CHANNELS - CLASS F GRATE WITH F1-LOCKING FEATURE</b>					
865-M8CBF1A	Half-Meter, Catch Basin w/ Galv Basket And F1 Class F ADA Ductile Iron Grate - 6" Outlet	B	1	1	\$970.26
865-M8N005F1A	Half-Meter, 8" Wide × 12.20" Height w/ F1 Class F ADA Ductile Iron Grate	B	1	1	\$465.24
865-M8N005SF1A	Half-Meter, 8" Wide × 12.20" Height, Side Out w/ F1 Class F ADA Ductile Iron Grate	B	1	1	\$547.71
865-M8N00BF1A	One-Meter, 8" Wide × 12.20" Height, Bottom Out w/ F1 Class F ADA Ductile Iron Grate	B	1	1	\$907.68
865-M8N00F1A	One-Meter, 8" Wide × 12.20" Height w/ F1 Class F ADA Ductile Iron Grate	B	1	1	\$776.01
<b>ACCESSORIES</b>					
865-6PC	PVC S&D Pipe Connection for 6" Outs	B	1	1	\$27.26
865-6RS	Rubber Sleeve/Seal For 6" Bottom Outs	B	1	1	\$65.21
865-8ECD	8" Closed End Cap - 1 Piece Iron	B	1	1	\$96.22
865-8LR	Grate-Locking Rod For 8" Channels	B	1	1	\$2.16
865-8OCD	8" Open End Cap - 1 Piece Iron	B	1	1	\$282.08
865-SHOVEL	Cleaning Shovel For Mini/Top/Maxi	B	1	1	\$203.49
865-TOOL	Grate-Locking Tool	B	1	1	\$39.14



865-M8N00DA



865-TOOL

**HydroTec™ MAXI System**

**Maxi 300 - 12" Wide**

Item Number	Item Description	Pkg Type	Min Qty	Case Qty	Price
<b>CHANNELS - CLASS E GRATE WITH F1-LOCKING FEATURE</b>					
865-M12PCBEA	Half-Meter, Catch Basin w/ Galv Basket And Class E ADA Ductile Iron Grate - 8" Outlet	B	1	1	\$1,762.20
865-M12PN005EA	Half-Meter, 12" Wide × 15.75" Height w/ Class E ADA Ductile Iron Grate	B	1	1	\$800.90
865-M12PN00BEA	One-Meter, 12" Wide × 15.75" Height, Bottom Out w/ Class E ADA Ductile Iron Grate	B	1	1	\$1,564.77
865-M12PN00EA	One-Meter, 12" Wide × 15.75" Height w/ Class E ADA Ductile Iron Grate	B	1	1	\$1,397.24



865-M12PN00EA

Supply

Drainage

Support

Specialties

Appendix

## HydroTec™ MAXI System (Cont)

### Maxi 300 - 12" Wide

Item Number	Item Description	Pkg Type	Min Qty	Case Qty	Price
<b>CHANNELS - CLASS F GRATE WITH F1-LOCKING FEATURE</b>					
865-M12PCBFA	Half-Meter, Catch Basin w/ Galv Basket And Class F ADA Ductile Iron Grate - 8" Outlet	B	1	1	\$1,932.43
865-M12PN005FA	Half-Meter, 12" Wide × 15.75" Height w/ Class F ADA Ductile Iron Grate	B	1	1	\$874.00
865-M12PN00BFA	One-Meter, 12" Wide × 15.75" Height, Bottom Out w/ Class F ADA Ductile Iron Grate	B	1	1	\$1,699.62
865-M12PN00FA	One-Meter, 12" Wide × 15.75" Height w/ Class F ADA Ductile Iron Grate	B	1	1	\$1,530.64
<b>ACCESSORIES</b>					
865-12ECD	12" Closed End Cap - 1 Piece Iron	B	1	1	\$142.35
865-12OCD	12" Open End Cap - 1 Piece Iron	B	1	1	\$281.72
865-8PC	PVC S&D Pipe Connection for 8" Outs	B	1	1	\$40.43
865-8RS	Rubber Sleeve/Seal For 8" Bottom Outs	B	1	1	\$83.01
865-SHOVEL	Cleaning Shovel For Mini/Top/Maxi	B	1	1	\$203.49

## HydroTec™ MAXI System

### Maxi 400 - 16" Wide



865-M16PN00EA

Item Number	Item Description	Pkg Type	Min Qty	Case Qty	Price
<b>CHANNELS - CLASS E GRATE WITH F1-LOCKING FEATURE</b>					
865-M16PCBEA	Half-Meter, Catch Basin w/ Galv Basket And Class E ADA Ductile Iron Grate - 8" Outlet	B	1	1	\$2,406.52
865-M16PN005EA	Half-Meter, 16" Wide × 15.75" Height w/ Class E ADA Ductile Iron Grate	B	1	1	\$1,076.21
865-M16PN00BEA	One-Meter, 16" Wide × 15.75" Height, Bottom Out w/ Class E ADA Ductile Iron Grate	B	1	1	\$2,010.05
865-M16PN00EA	One-Meter, 16" Wide × 15.75" Height w/ Class E ADA Ductile Iron Grate	B	1	1	\$1,856.17
<b>CHANNELS - CLASS F GRATE WITH F1-LOCKING FEATURE</b>					
865-M16PCBFA	Half-Meter, Catch Basin w/ Galv Basket And Class F ADA Ductile Iron Grate - 8" Outlet	B	1	1	\$2,740.71
865-M16PN005FA	Half-Meter, 16" Wide × 15.75" Height w/ Class F ADA Ductile Iron Grate	B	1	1	\$1,224.55
865-M16PN00BFA	One-Meter, 16" Wide × 15.75" Height, Bottom Out w/ Class F ADA Ductile Iron Grate	B	1	1	\$2,262.18
865-M16PN00FA	One-Meter, 16" Wide × 15.75" Height w/ Class F ADA Ductile Iron Grate	B	1	1	\$2,102.95
<b>ACCESSORIES</b>					
865-16ECD	16" Ductile Closed End Cap	B	1	1	\$175.02
865-16OCD	16" Ductile Open End Cap	B	1	1	\$335.09
865-8PC	PVC S&D Pipe Connection for 8" Outs	B	1	1	\$40.43
865-8RS	Rubber Sleeve/Seal For 8" Bottom Outs	B	1	1	\$83.01
865-SHOVEL	Cleaning Shovel For Mini/Top/Maxi	B	1	1	\$203.49

Supply

Drainage

Support

Specialties

Appendix

HydroTec™ TOP System

Top 100 - 4" Wide

Item Number	Item Description	Pkg Type	Min Qty	Case Qty	Price
<b>GRATES</b>					
865-T4DI5CL	Half-Meter, Class C, Ductile Iron, Long Slot, ADA	B	1	1	\$73.93
865-T4DI5CX	Half-Meter, Class C, Ductile Iron, Cross-Slot	B	1	1	\$68.54
865-T4GS5AS	Half-Meter, Class A, Galvanized Steel, Slotted	B	1	1	\$37.16
865-T4GS5CM	Half-Meter, Class C, Galvanized Steel, Mesh, ADA	B	1	1	\$98.25
865-T4GS5CP	Half-Meter, Class C, Galvanized Steel, Perforated	B	1	1	\$106.49
865-T4GS5CS	Half-Meter, Class C, Galvanized Steel, Slotted	B	1	1	\$93.15
865-T4GS5AP	Half-Meter, Class A, Galvanized Steel, Perforated	B	1	1	\$58.16
865-T4GSAP	One-Meter, Class A, Galvanized Steel, Perforated	B	1	1	\$92.72
865-T4GSAS	One-Meter, Class A, Galvanized Steel, Slotted	B	1	1	\$61.15
<b>865-T4GSCM</b>	One-Meter, Class C, Galvanized Steel, Mesh, ADA	B	1	1	\$142.23
865-T4GSCP	One-Meter, Class C, Galvanized Steel, Perforated	B	1	1	\$175.32
865-T4GSCS	One-Meter, Class C, Galvanized Steel, Slotted	B	1	1	\$131.85
865-T4P5BL	Half-Meter, Class B, Plastic, Long Slot, ADA	B	1	1	\$73.93
<b>CHANNELS</b>					
865-T4N10	One-Meter, 4" Wide × 6.30" Height, Neutral	B	1	1	\$147.82
865-T4N105S	Half-Meter, 4" Wide × 6.30" Height, Neutral, Side Out	B	1	1	\$126.99
865-T4N10B	One-Meter, 4" Wide × 6.30" Height, Neutral, Bottom Out	B	1	1	\$206.94
865-T4N15	One-Meter, 4" Wide × 7.28 Height, Neutral	B	1	1	\$147.82
865-T4N155	Half-Meter, 4" Wide × 7.28 Height, Neutral	B	1	1	\$99.39
865-T4N15B	One-Meter, 4" Wide × 7.28 Height, Neutral, Bottom Out	B	1	1	\$206.94
865-T4N20	One-Meter, 4" Wide × 8.27 Height, Neutral	B	1	1	\$147.82
865-T4N205	Half-Meter, 4" Wide × 8.27 Height, Neutral	B	1	1	\$99.39
865-T4N205S	Half-Meter, 4" Wide × 8.27 Height, Neutral, Side Out	B	1	1	\$126.99
865-T4N20B	One-Meter, 4" Wide × 8.27 Height, Neutral, Bottom Out	B	1	1	\$206.94
865-T4S01	One-Meter, 4" Wide, Slope # 1 w/ Galv Edge-Rails	B	1	1	\$147.82
865-T4S02	One-Meter, 4" Wide, Slope # 2 w/ Galv Edge-Rails	B	1	1	\$147.82
865-T4S03	One-Meter, 4" Wide, Slope # 3 w/ Galv Edge-Rails	B	1	1	\$147.82
865-T4S04	One-Meter, 4" Wide, Slope # 4 w/ Galv Edge-Rails	B	1	1	\$147.82
865-T4S05	One-Meter, 4" Wide, Slope # 5 w/ Galv Edge-Rails	B	1	1	\$147.82
865-T4S06	One-Meter, 4" Wide, Slope # 6 w/ Galv Edge-Rails	B	1	1	\$147.82
865-T4S07	One-Meter, 4" Wide, Slope # 7 w/ Galv Edge-Rails	B	1	1	\$147.82
865-T4S08	One-Meter, 4" Wide, Slope # 8 w/ Galv Edge-Rails	B	1	1	\$147.82
865-T4S09	One-Meter, 4" Wide, Slope # 9 w/ Galv Edge-Rails	B	1	1	\$147.82
865-T4S10	One-Meter, 4" Wide, Slope # 10 w/ Galv Edge-Rails	B	1	1	\$147.82
865-T4S11	One-Meter, 4" Wide, Slope # 11 w/ Galv Edge-Rails	B	1	1	\$147.82
865-T4S12	One-Meter, 4" Wide, Slope # 12 w/ Galv Edge-Rails	B	1	1	\$147.82
865-T4S13	One-Meter, 4" Wide, Slope # 13 w/ Galv Edge-Rails	B	1	1	\$147.82

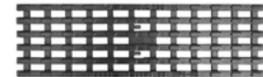

865-T4DI5CL



865-T4GS5CM



865-T4GS5CS

Supply

Drainage

Support

Specialties

Appendix

**HydroTec™ TOP System (Cont)**

**Top 100 - 4" Wide**

Item Number	Item Description	Pkg Type	Min Qty	Case Qty	Price
<b>CHANNELS</b>					
865-T4S14	One-Meter, 4" Wide, Slope # 14 w/ Galv Edge-Rails	B	1	1	\$147.82
865-T4S15	One-Meter, 4" Wide, Slope # 15 w/ Galv Edge-Rails	B	1	1	\$147.82
865-T4S16	One-Meter, 4" Wide, Slope # 16 w/ Galv Edge-Rails	B	1	1	\$147.82
865-T4S17	One-Meter, 4" Wide, Slope # 17 w/ Galv Edge-Rails	B	1	1	\$147.82
865-T4S18	One-Meter, 4" Wide, Slope # 18 w/ Galv Edge-Rails	B	1	1	\$147.82
865-T4S19	One-Meter, 4" Wide, Slope # 19 w/ Galv Edge-Rails	B	1	1	\$147.82
865-T4S20	One-Meter, 4" Wide, Slope # 20 w/ Galv Edge-Rails	B	1	1	\$147.82
865-T4S21	One-Meter, 4" Wide, Slope # 21 w/ Galv Edge-Rails	B	1	1	\$147.82
865-T4S22	One-Meter, 4" Wide, Slope # 22 w/ Galv Edge-Rails	B	1	1	\$147.82
865-T4S23	One-Meter, 4" Wide, Slope # 23 w/ Galv Edge-Rails	B	1	1	\$147.82
865-T4S24	One-Meter, 4" Wide, Slope # 24 w/ Galv Edge-Rails	B	1	1	\$147.82
865-T4S25	One-Meter, 4" Wide, Slope # 25 w/ Galv Edge-Rails	B	1	1	\$147.82
865-T4S26	One-Meter, 4" Wide, Slope # 26 w/ Galv Edge-Rails	B	1	1	\$147.82
865-T4S27	One-Meter, 4" Wide, Slope # 27 w/ Galv Edge-Rails	B	1	1	\$147.82
865-T4S28	One-Meter, 4" Wide, Slope # 28 w/ Galv Edge-Rails	B	1	1	\$147.82
865-T4S29	One-Meter, 4" Wide, Slope # 29 w/ Galv Edge-Rails	B	1	1	\$147.82
865-T4S30	One-Meter, 4" Wide, Slope # 30 w/ Galv Edge-Rails	B	1	1	\$147.82
<b>LOW-PROFILE CHANNELS</b>					
865-T4LP003	One-Meter, 4" Wide × 3.15" Height, Neutral	B	1	1	\$112.59
865-T4LP0053	Half-Meter, 4" Wide × 3.15" Height, Neutral	B	1	1	\$94.03
865-T4LP00B03	One-Meter, 4" Wide × 3.15" Height, Neutral, Bottom Out	B	1	1	\$209.35
865-T4N00	One-Meter, 4" Wide × 4.33" Height, Neutral	B	1	1	\$147.82
865-T4N005	Half-Meter, 4" Wide × 4.33" Height, Neutral	B	1	1	\$99.39
865-T4N00B	One-Meter, 4" Wide × 4.33" Height, Neutral, Bottom Out	B	1	1	\$206.94
<b>CATCH BASIN</b>					
865-T4CB	Half-Meter, Catch Basin w/ Galv Steel Debris Basket - 6" Outlet	B	1	1	\$301.23



865-T4N10



865-T4N00



865-T4CB

Supply

Drainage

Support

Specialties

Appendix



**HydroTec™ TOP System (Cont)**

**Top 100 - 4" Wide**

Item Number	Item Description	Pkg Type	Min Qty	Case Qty	Price
<b>ACCESSORIES</b>					
865-4BK	Installation Bracket for Maxi/Top 100 Channels	B	1	1	\$44.50
865-4EC	4" Closed End Cap - 2 Piece	B	1	1	\$40.92
865-4LPEC3	4" Closed End Cap For 3.15" Channel	B	1	1	\$29.65
865-4LPEC4	4" Closed End Cap For 4.33" Channel	B	1	1	\$29.65
865-4LR	Grate-Locking Rod For 4" Channels	B	1	1	\$1.73
865-4OC	4" Open End Cap - 2 Piece	B	1	1	\$40.92
865-4PC	4" PVC S&D Pipe Connection	B	1	1	\$14.82
865-4RS	4" Rubber Sleeve / Seal For Bottom Outs	B	1	1	\$54.44
865-SHOVEL	Cleaning Shovel For Mini/Top/Maxi	B	1	1	\$203.49
865-TOOL	Grate-Locking Tool	B	1	1	\$39.14
865-TOOLP	Grate-Locking Tool For Perf/Mesh Grates	B	1	1	\$39.14



Supply

Drainage

Support

Specialties

Appendix



# HydroBlock™ System

**HydroBlock™ 100**

**HydroBlock™ 150**

**HydroBlock™ 200**

**HydroBlock™ 300**

One-piece ductile iron channel and grate system designed for ultimate durability and rattle-free operation.

Sections join together easily with no fasteners - joints are water-tight and anti-torque. One-piece design is perfect for heavy loads and high-traffic areas.

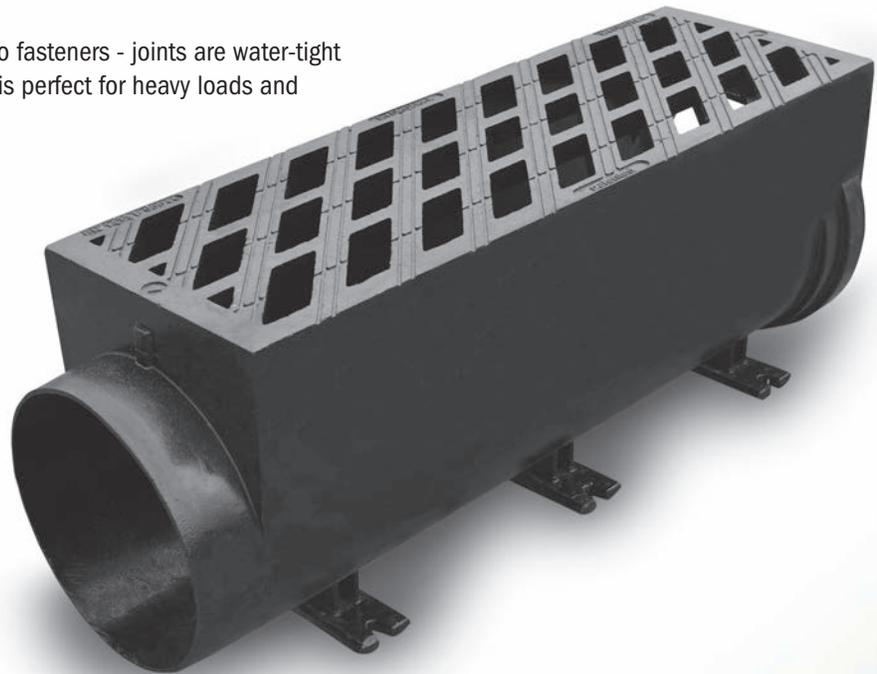



**HydroBlock™ 100**

Item Number	Item Description	Pkg Type	Min Qty	Case Qty	Price
865-HB4005BFA	Half-Meter, 4" Wide, Bottom Out w/ Ductile Iron Removable Grate	B	1	1	\$508.71
865-HB4005SFA	Half-Meter, 4" Wide, Left/Right Side Out w/ Ductile Iron Removable Grate	B	1	1	\$508.71
865-HB400FA	One-Meter, 4" Wide Ductile Iron Channel/Grate	B	1	1	\$500.30
865-HB4CBFA	Catch Basin w/ Ductile Iron Removable Grate	B	1	1	\$989.51
<b>ACCESSORIES</b>					
865-HB4EC	Closed End Cap For Socket End	B	1	1	\$19.88
865-HB4INSB	Installation Aid Tool	B	1	1	\$335.51
865-HB4OC	Closed End Cap For Spigot End	B	1	1	\$19.88



865-HB400FA



865-HB4EC

**HydroBlock™ 150**

Item Number	Item Description	Pkg Type	Min Qty	Case Qty	Price
865-HB6005BFA	Half-Meter, 6" Wide, Bottom Out w/Ductile Iron Removable Grate	B	1	1	\$626.07
865-HB6005HSFA	Half-Meter, 6" Wide, Left/Right/End Out w/ Ductile Iron Removable Grate	B	1	1	\$626.07
865-HB600FA	One-Meter, 6" Wide Ductile Iron Channel/Grate	B	1	1	\$754.01
865-HB6CBFA	Catch Basin w/ Ductile Iron Removable Grate	B	1	1	\$1,137.27
<b>ADA COMPLIANT</b>					
865-HB6ADA005BFA	Half-Meter, 6" Wide, Bottom Out w/ ADA Ductile Iron Removable Grate	B	1	1	\$676.68
865-HB6ADA005FA	Half-Meter, 6" Wide, w/ ADA Ductile Iron Removable Grate	B	1	1	\$676.68
865-HB6ADA005HSFA	Half-Meter, 6" Wide, Left/Right/End Out w/ ADA Ductile Iron Removable Grate	B	1	1	\$676.68
865-HB6ADA00FA	One-Meter, 6" Wide ADA Ductile Iron Channel/Grate	B	1	1	\$817.25
865-HB6ADACBFA	Catch Basin w/ ADA Ductile Iron Removable Grate	B	1	1	\$1,225.96
<b>ACCESSORIES</b>					
865-HB6AINSB	Installation Aid Tool for ADA Pattern	B	1	1	\$335.51
865-HB6DS	Domed Debris Strainer for Bottom Outlet	B	1	1	\$46.40
865-HB6EC	Closed End Cap For Socket End	B	1	1	\$26.80
865-HB6INSB	Installation Aid Tool	B	1	1	\$335.51
865-HB6OC	Closed End Cap For Spigot End	B	1	1	\$26.80



865-HB600FA



865-HB6ADA005HSFA

**HydroBlock™ 200**

Item Number	Item Description	Pkg Type	Min Qty	Case Qty	Price
865-HB8005BFA	Half-Meter, 8" Wide, Bottom Out w/ Ductile Iron Removable Grate	B	1	1	\$871.88
865-HB8005SFA	Half-Meter, 8" Wide, Left/Right Side Out w/ Ductile Iron Removable Grate	B	1	1	\$871.87
865-HB800FA	One-Meter, 8" Wide Ductile Iron Channel/Grate	B	1	1	\$1,130.39
865-HB8CBFA	Catch Basin w/ Ductile Iron Removable Grate	B	1	1	\$1,259.58



865-HB800FA

Supply

Drainage

Support

Specialties

Appendix



865-HB80C



865-HB1200FA



865-HB12ADA005BFA



865-HB120C

### HydroBlock™ 200 (Cont)

Item Number	Item Description	Pkg Type	Min Qty	Case Qty	Price
<b>ADA COMPLIANT</b>					
865-HB8ADA005BFA	Half-Meter, 8" Wide, Bottom Out w/ ADA Ductile Iron Removable Grate	B	1	1	\$941.45
865-HB8ADA005FA	Half-Meter, 8" Wide, w/ ADA Ductile Iron Removable Grate	B	1	1	\$941.45
865-HB8ADA005SFA	Half-Meter, 8" Wide, Left/Right Side Out w/ ADA Ductile Iron Removable Grate	B	1	1	\$941.45
865-HB8ADA00FA	One-Meter, 8" Wide ADA Ductile Iron Channel/Grate	B	1	1	\$1,225.37
865-HB8ADACBFA	Catch Basin w/ ADA Ductile Iron Removable Grate	B	1	1	\$1,360.90
<b>ACCESSORIES</b>					
865-HB6AINSB	Installation Aid Tool for ADA Pattern	B	1	1	\$335.51
865-HB6INSB	Installation Aid Tool	B	1	1	\$335.51
865-HB8EC	Closed End Cap For Socket End	B	1	1	\$24.85
865-HB80C	Closed End Cap For Spigot End	B	1	1	\$24.85

### HydroBlock™ 300

Item Number	Item Description	Pkg Type	Min Qty	Case Qty	Price
865-HB12005BFA	Three-Quarter-Meter, 12" Wide, Bottom Out w/ Ductile Iron Removable Grate	B	1	1	\$2,182.71
865-HB1200FA	One-Meter, 12" Wide Ductile Iron Channel/Grate	B	1	1	\$2,182.71
<b>ADA COMPLIANT</b>					
865-HB12ADA005BFA	Three-Quarter-Meter, 12" Wide, Bottom Out w/ ADA Ductile Iron Removable Grate	B	1	1	\$2,359.93
865-HB12ADA005FA	Three-Quarter-Meter, 12" Wide, w/ ADA Ductile Iron Removable Grate	B	1	1	\$2,359.93
865-HB12ADA005SFA	Three Quarter-Meter, 12" Wide, Left/Right Side Out w/ ADA Ductile Iron Removable Grate	B	1	1	\$2,359.93
865-HB12ADA00FA	One-Meter, 12" Wide ADA Ductile Iron Channel/Grate	B	1	1	\$2,359.93
<b>ACCESSORIES</b>					
865-12PC	12" PVC S&D Pipe Connector	B	1	1	\$93.12
865-HB12EC	Closed End Cap For Socket End	B	1	1	\$166.01
865-HB120C	Closed End Cap For Spigot End	B	1	1	\$166.01
865-HB12S	Debris Bucket For Vertical Out	B	1	1	\$360.35
865-HB6AINSB	Installation Aid Tool for ADA Pattern	B	1	1	\$335.51
865-HB6INSB	Installation Aid Tool	B	1	1	\$335.51

# HydroLine™ System

The HydroLine™ is a unique, ultra-low-profile system designed for fast/easy installations or height-restricted applications. Rib-design channels made from ductile iron or aluminum lock into concrete slab and stand up to heavy-duty traffic.

The system is low-maintenance and perfect for covered parking areas or thresholds to prevent surface water cross-over.







HydroLine™ System

Item Number	Item Description	Pkg Type	Min Qty	Case Qty	Price
<b>DUCTILE IRON CHANNELS</b>					
865-HL4L	4-1/2" Wide Channel - Corner Section, 2 Pcs	B	1	1	\$708.24
865-HL4N005BF	Half-Meter, 4-1/2" Wide Channel, Neutral w/ Out Curb End	B	1	1	\$169.08
865-HL4N005K	Half-Meter, 4-1/2" Wide Channel, Neutral w/ Curb End	B	1	1	\$181.31
865-HL4N00CSF	One-Meter, 4-1/2" Wide Channel, Neutral w/ Cleaning End	B	1	1	\$265.70
865-HL4N00F	One-Meter, 4-1/2" Wide Channel, Neutral	B	1	1	\$184.95
<b>POWDER-COATED ALUMINUM CHANNELS</b>					
865-HLP4AB	5" Wide Channel - Bottom Outlet Section	B	1	1	\$259.94
865-HLP4C	5" Wide Channel - Corner Section, 2 Pcs	B	1	1	\$733.71
865-HLP4N00F1M	One-Meter, 5" Wide Channel, Neutral	B	1	1	\$543.66
865-HLP4N00F3M	Three-Meter, 5" Wide Channel, Neutral	B	1	1	\$806.01
865-HLP4T	5" Wide Channel - Tee Section, 3 Pcs	B	1	1	\$1,101.74
865-HLP4X	5" Wide Channel - Cross Section, 4 Pcs	B	1	1	\$1,467.11
<b>ACCESSORIES</b>					
865-HLAC	One-Meter Installation Cover For Aluminum Channels	B	1	1	\$203.27
865-HLCE	Connection Element For Iron Channels	B	1	1	\$41.72
865-HLDC	One-Meter Installation Cover For Iron Channels	B	1	1	\$203.27
865-HLEC	End Wall For Iron Channels	B	1	1	\$41.72
865-HLISC	Installation Bracket For Iron Channels	B	1	1	\$41.73
865-HLPCE	Connection Element For Aluminum Channels	B	1	1	\$41.72
865-HLPEC	End Wall For Aluminum Channels	B	1	1	\$41.73
865-HLPED	Installation Pedestal For Iron Channels	B	1	1	\$219.58
865-HLPISC	Installation Bracket For Aluminum Channels	B	1	1	\$41.73
865-HLPPED	Installation Pedestal For Aluminum Channels	B	1	1	\$237.15
865-RAKE	Cleaning Rake For Iron Channels	B	1	1	\$237.15
865-RAKEP	Cleaning Rake For Aluminum Channels	B	1	1	\$280.25



865-HL4N005BF

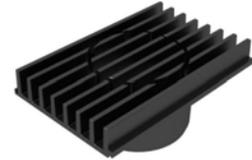

865-HLP4AB



865-RAKE

Supply

Drainage

Support

Specialties

Appendix



# **Residential Drainage**

**Shower Drains**

**Floor Drains**

**Closet Flanges**

**Backwater Valves**

**Air Admittance Valves**

**Accessories**

# Residential Drainage

## Shower Drains

Shower drains designed for tile floors and prefabricated floors and modules. PVC, ABS, and cast iron connections available. Designed in accordance with *ASME A112.18.2/CSA B125.2 Standard for Plumbing Waste Fittings*.

## Floor Drains

Floor drains for residential and other non-commercial applications. PVC, ABS and cast iron connections available. Designed in accordance with *ASME A112.6.3 Standard for Floor and Trench Drains*.

## Closet Flanges

Closet flanges for standard, floor mounted toilets. Spacer and accessory products for repair and replacement applications. Solvent weld connections designed in accordance with ASTM D2665 (PVC) / ASTM D2661 (ABS)

## Backwater Valves

One-way valves designed to prevent back flow of waste lines in both shallow and deep-bury applications. PVC and ABS connections. Designed in accordance with *ASME A112.14.1 Standard for Backwater Valves*.

## Air Admittance Valves

One-way valves designed to allow air into vent lines for drainage systems and prevent sewer gas from entering the living space. PVC and ABS connections available. Designed in accordance with ANSI/ASSE 1050 and 1051.

## Accessories

Saddle tee fittings, condensate traps and other residential accessory items.

# Shower Drains

**Shower Pan Drains**

**StreamLine™ Linear Drains**

**Shower Module Drains**

**Freestanding Tub Drain**

**Replacement Strainers**

A wide variety of shower drains available for tile floors or prefabricated shower floors and modules.

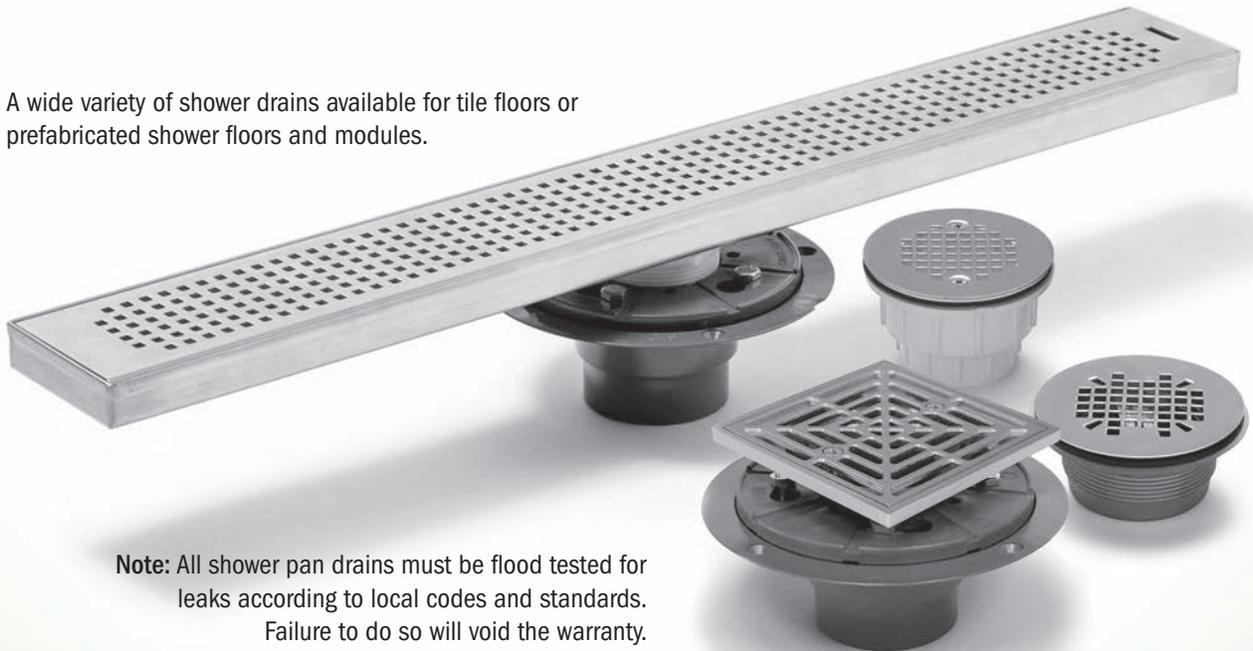

**Note:** All shower pan drains must be flood tested for leaks according to local codes and standards. Failure to do so will void the warranty.



**821-2P**  
Page 415



**821-T2P**  
Page 415



**821-270PQ**  
Page 415



**821-T270PQ**  
Page 415



**821-200PNQ**  
Page 416



**821-T200PNQ**  
Page 416



**821-2PTQ**  
Page 420



**821-2INS**  
Page 423



**863-435CQ**  
Page 422



**823-TX26WP**  
Page 424



**823-T2A36V**  
Page 425



**825-2P**  
Page 426



**827-2B**  
Page 426



**828-2**  
Page 426



**827-2J**  
Page 427



**826-2P**  
Page 427



**827-2SN**  
Page



**821-2SCRPK1**  
Page 429

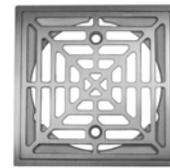

**821-2SKQPK1**  
Page 430

**Screw-On Stainless Steel Strainer**

**2" PVC/ABS - Sch.40 Hub Connection**

Item Number	Item Description	Pkg Type	Min Qty	Case Qty	Price
<b>ROUND STRAINER - NO INSERTS</b>					
821-2A	ABS Hub - 4-1/4" Rnd Strainer	BI	20	20	\$13.65
821-2APK	ABS Hub - 4-1/4" Rnd Strainer	CI	8	8	\$14.65
821-2P	PVC Hub - 4-1/4" Rnd Strainer	BI	20	20	\$13.65
821-2PPK	PVC Hub - 4-1/4" Rnd Strainer	CI	8	8	\$14.65
821-T2A	ABS Hub - 4-1/4" Rnd Strainer w/ DoubleDuty™ Test Plug	BI	1	10	\$13.65
821-T2P	PVC Hub - 4-1/4" Rnd Strainer w/ DoubleDuty™ Test Plug	BI	1	10	\$13.65
<b>ROUND STRAINER WITH BRASS INSERTS</b>					
821-200A	ABS Hub - 4-1/4" Rnd Strainer	BI	20	20	\$14.36
821-200P	PVC Hub - 4-1/4" Rnd Strainer	BI	20	20	\$14.36
821-T200A	ABS Hub - 4-1/4" Rnd Strainer w/ DoubleDuty™ Test Plug	BI	10	10	\$14.36
821-T200P	PVC Hub - 4-1/4" Rnd Strainer w/ DoubleDuty™ Test Plug	BI	10	10	\$14.36
<b>COMPONENT ITEMS</b>					
821-2LSPC	4-1/4" Rnd Strainer	BI	10	10	\$5.77
821-2LSPCI	4-1/4" Rnd Strainer	BI	10	10	\$6.54
821-HA2	2" ABS Hub - Base & Collar Only	BI	25	25	\$8.13
821-HP2	2" PVC Hub - Base & Collar Only	BI	25	25	\$8.13
821-THA2	2" ABS Hub - Base & Collar Only w/ DoubleDuty™ Test Plug	BI	25	25	\$8.13
821-THP2	2" PVC Hub - Base & Collar Only w/ DoubleDuty™ Test Plug	BI	25	25	\$8.13
<b>ACCESSORIES</b>					
821-EX2	Threaded Extension Adapter - 2-3/8" Min - 4-3/4" Max	BI	1	10	\$4.94
821-H	Hair Catcher	B	10	100	\$0.75
821-TP	Test Plug For 821 Shower Drain	BI	10	10	\$3.55
835-2	Trapshield™ For 2" Drain Outlet	BI	1	50	\$56.31



821-2A



821-T200P



821-HP2

**Snap-In Stainless Steel Strainer**

**2" PVC/ABS - Sch.40 Hub Connection**

Item Number	Item Description	Pkg Type	Min Qty	Case Qty	Price
<b>ROUND STRAINER</b>					
821-270A	ABS Hub - 4-1/4" Rnd Strainer	BI	20	20	\$13.65
821-270P	PVC Hub - 4-1/4" Rnd Strainer	BI	20	20	\$13.65
821-T270A	ABS Hub - 4-1/4" Rnd Strainer w/ DoubleDuty™ Test Plug	BI	1	10	\$13.65
821-T270P	PVC Hub - 4-1/4" Rnd Strainer w/ DoubleDuty™ Test Plug	BI	10	10	\$13.65
<b>SQUARE STRAINER</b>					
821-270AQ	ABS Hub - 4-1/4" Sqr Strainer	BI	20	20	\$21.65
821-270PQ	PVC Hub - 4-1/4" Sqr Strainer	BI	20	20	\$21.65
821-T270AQ	ABS Hub - 4-1/4" Sqr Strainer w/ DoubleDuty™ Test Plug	BI	1	10	\$21.65
821-T270PQ	PVC Hub - 4-1/4" Sqr Strainer w/ DoubleDuty™ Test Plug	BI	1	10	\$21.65



821-270P



821-270PQ

Supply

Drainage

Support

Specialties

Appendix



821-2A



821-EX2



821-T200ANR



821-200PNQ

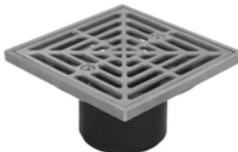

821-2LNQ



821-EX2

### Snap-In Stainless Steel Strainer (Cont)

#### 2" PVC/ABS - Sch.40 Hub Connection

Item Number	Item Description	Pkg Type	Min Qty	Case Qty	Price
<b>COMPONENT ITEMS</b>					
821-2LSNQ	4-1/4" Sqr Strainer	BI	10	10	\$12.39
821-2LSPN	4-1/4" Rnd Strainer	BI	10	10	\$5.77
821-HA2	2" ABS Hub - Base & Collar Only	BI	25	25	\$8.13
821-HP2	2" PVC Hub - Base & Collar Only	BI	25	25	\$8.13
821-THA2	2" ABS Hub - Base & Collar Only w/ DoubleDuty™ Test Plug	BI	25	25	\$8.13
821-THP2	2" PVC Hub - Base & Collar Only w/ DoubleDuty™ Test Plug	BI	25	25	\$8.13
<b>ACCESSORIES</b>					
821-2QAS	Round-to-Square Strainer & Adapter Kit - Stnls Steel Finish Strainer	CI	5	5	\$7.06
821-EX2	Threaded Extension Adapter - 2-3/8" Min - 4-3/4" Max	BI	1	10	\$4.94
821-H	Hair Catcher	B	10	100	\$0.75
821-TP	Test Plug For 821 Shower Drain	BI	10	10	\$3.55
835-2	Trapshield™ For 2" Drain Outlet	BI	1	50	\$56.31

### Deluxe Nickel-Bronze Ring & Strainer

#### 2" PVC/ABS - Sch.40 Hub Connection

Item Number	Item Description	Pkg Type	Min Qty	Case Qty	Price
<b>ROUND RING &amp; STRAINER</b>					
821-200ANR	ABS Hub - 4-1/2" Rnd Strainer	BI	5	5	\$53.37
821-200PNR	PVC Hub - 4-1/2" Rnd Strainer	BI	5	5	\$53.37
821-T200ANR	ABS Hub - 4-1/2" Rnd Strainer w/ DoubleDuty™ Test Plug	BI	5	5	\$53.37
821-T200PNR	PVC Hub - 4-1/2" Rnd Strainer w/ DoubleDuty™ Test Plug	BI	5	5	\$53.37
<b>SQUARE RING &amp; STRAINER</b>					
821-200ANQ	ABS Hub - 4-1/2" Sqr Strainer	BI	5	5	\$67.61
821-200PNQ	PVC Hub - 4-1/2" Sqr Strainer	BI	5	5	\$67.61
821-T200ANQ	ABS Hub - 4-1/2" Sqr Strainer w/ DoubleDuty™ Test Plug	BI	1	5	\$67.61
821-T200PNQ	PVC Hub - 4-1/2" Sqr Strainer w/ DoubleDuty™ Test Plug	BI	5	5	\$67.61
<b>COMPONENT ITEMS</b>					
821-2LNQ	4-1/2" Sqr Strainer	BI	1	5	\$59.47
821-2LNR	4-1/4" Rnd Strainer	BI	1	5	\$45.23
821-MHA2	2" ABS Hub - Base & Collar Only	BI	25	25	\$8.13
821-MHP2	2" PVC Hub - Base & Collar Only	BI	25	25	\$8.13
821-TMHA2	2" ABS Hub - Base & Collar Only w/ DoubleDuty™ Test Plug	BI	25	25	\$8.13
821-TMHP2	2" PVC Hub - Base & Collar Only w/ DoubleDuty™ Test Plug	BI	25	25	\$8.13
<b>ACCESSORIES</b>					
821-EX2	Threaded Extension Adapter - 2-3/8" Min - 4-3/4" Max	BI	1	10	\$4.94
821-H	Hair Catcher	B	10	100	\$0.75
821-TP	Test Plug For 821 Shower Drain	BI	10	10	\$3.55
835-2	Trapshield™ For 2" Drain Outlet	BI	1	50	\$56.31



### Deluxe Polished Stainless Ring & Strainer

#### 2" PVC/ABS - Sch.40 Hub Connection

Item Number	Item Description	Pkg Type	Min Qty	Case Qty	Price
<b>ROUND RING &amp; STRAINER</b>					
821-200ACR	ABS Hub - 4-1/2" Rnd Strainer	BI	5	5	\$67.61
821-200PCR	PVC Hub - 4-1/2" Rnd Strainer	BI	5	5	\$67.61
<b>821-T200ACR</b>	ABS Hub - 4-1/2" Rnd Strainer w/ DoubleDuty™ Test Plug	BI	5	5	\$67.61
821-T200PCR	PVC Hub - 4-1/2" Rnd Strainer w/ DoubleDuty™ Test Plug	BI	5	5	\$67.61
<b>SQUARE RING &amp; STRAINER</b>					
821-200ACQ	ABS Hub - 4-1/2" Sqr Strainer	BI	5	5	\$81.83
821-200PCQ	PVC Hub - 4-1/2" Sqr Strainer	BI	5	5	\$81.83
821-T200ACQ	ABS Hub - 4-1/2" Sqr Strainer w/ DoubleDuty™ Test Plug	BI	1	5	\$81.83
821-T200PCQ	PVC Hub - 4-1/2" Sqr Strainer w/ DoubleDuty™ Test Plug	BI	1	5	\$81.83
<b>COMPONENT ITEMS</b>					
821-2LCQ	4-1/2" Sqr Strainer	BI	1	5	\$73.69
821-2LCR	4-1/2" Rnd Strainer	BI	1	5	\$59.47
821-MHA2	2" ABS Hub - Base & Collar Only	BI	25	25	\$8.13
821-MHP2	2" PVC Hub - Base & Collar Only	BI	25	25	\$8.13
<b>821-TMHA2</b>	2" ABS Hub - Base & Collar Only w/ DoubleDuty™ Test Plug	BI	25	25	\$8.13
<b>821-TMHP2</b>	2" PVC Hub - Base & Collar Only w/ DoubleDuty™ Test Plug	BI	25	25	\$8.13
<b>ACCESSORIES</b>					
821-EX2	Threaded Extension Adapter - 2-3/8" Min - 4-3/4" Max	BI	1	10	\$4.94
821-H	Hair Catcher	B	10	100	\$0.75
821-TP	Test Plug For 821 Shower Drain	BI	10	10	\$3.55
835-2	Trapshield™ For 2" Drain Outlet	BI	1	50	\$56.31



821-200ACR



821-200PCQ

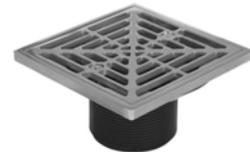

821-2LCQ



821-EX2

### Deluxe Satin Nickel Finish Ring & Strainer

#### 2" PVC/ABS - Sch.40 Hub Connection

Item Number	Item Description	Pkg Type	Min Qty	Case Qty	Price
<b>ROUND RING &amp; STRAINER</b>					
821-200AKR	ABS Hub - 4-1/2" Rnd Strainer	BI	5	5	\$67.61
821-200PKR	PVC Hub - 4-1/2" Rnd Strainer	BI	5	5	\$67.61
821-T200AKR	ABS Hub - 4-1/2" Rnd Strainer w/ DoubleDuty™ Test Plug	BI	1	5	\$67.61
821-T200PKR	PVC Hub - 4-1/2" Rnd Strainer w/ DoubleDuty™ Test Plug	BI	5	5	\$67.61
<b>SQUARE RING &amp; STRAINER</b>					
821-200AKQ	ABS Hub - 4-1/2" Sqr Strainer	BI	5	5	\$81.83
821-200PKQ	PVC Hub - 4-1/2" Sqr Strainer	BI	5	5	\$81.83
821-T200AKQ	ABS Hub - 4-1/2" Sqr Strainer w/ DoubleDuty™ Test Plug	BI	1	5	\$81.83
821-T200PKQ	PVC Hub - 4-1/2" Sqr Strainer w/ DoubleDuty™ Test Plug	BI	1	5	\$81.83



821-200AKR



821-200PKQ

Supply

Drainage

Support

Specialties

Appendix

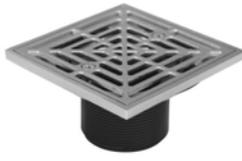

821-2LKQ



821-EX2



821-200PSQ



821-200ASQ



821-EX2

## Deluxe Satin Nickel Finish Ring & Strainer (Cont)

### 2" PVC/ABS - Sch.40 Hub Connection

Item Number	Item Description	Pkg Type	Min Qty	Case Qty	Price
<b>COMPONENT ITEMS</b>					
821-2LKQ	4-1/2" Sqr Strainer	BI	1	5	\$73.69
<b>821-2LKR</b>	4-1/2" Rnd Strainer	BI	1	5	\$59.47
821-MHA2	2" ABS Hub - Base & Collar Only	BI	25	25	\$8.13
821-MHP2	2" PVC Hub - Base & Collar Only	BI	25	25	\$8.13
<b>821-TMHA2</b>	2" ABS Hub - Base & Collar Only w/ DoubleDuty™ Test Plug	BI	25	25	\$8.13
<b>821-TMHP2</b>	2" PVC Hub - Base & Collar Only w/ DoubleDuty™ Test Plug	BI	25	25	\$8.13
<b>ACCESSORIES</b>					
821-EX2	Threaded Extension Adapter - 2-3/8" Min - 4-3/4" Max	BI	1	10	\$4.94
821-H	Hair Catcher	B	10	100	\$0.75
821-TP	Test Plug For 821 Shower Drain	BI	10	10	\$3.55
835-2	Trapshield™ For 2" Drain Outlet	BI	1	50	\$56.31

## Deluxe Matte Stainless Ring & Strainer

### 2" PVC/ABS - Sch.40 Hub Connection

Item Number	Item Description	Pkg Type	Min Qty	Case Qty	Price
<b>ROUND RING &amp; STRAINER</b>					
821-200ASR	ABS Hub - 4-1/2" Rnd Strainer	BI	5	5	\$53.37
821-200PSR	PVC Hub - 4-1/2" Rnd Strainer	BI	5	5	\$53.37
821-T200ASR	ABS Hub - 4-1/2" Rnd Strainer w/ DoubleDuty™ Test Plug	BI	5	5	\$53.37
821-T200PSR	PVC Hub - 4-1/2" Rnd Strainer w/ DoubleDuty™ Test Plug	BI	5	5	\$53.37
<b>SQUARE RING &amp; STRAINER</b>					
821-200ASQ	ABS Hub - 4-1/2" Sqr Strainer	BI	5	5	\$67.61
821-200PSQ	PVC Hub - 4-1/2" Sqr Strainer	BI	5	5	\$67.61
821-T200ASQ	ABS Hub - 4-1/2" Sqr Strainer w/ DoubleDuty™ Test Plug	BI	1	5	\$67.61
821-T200PSQ	PVC Hub - 4-1/2" Sqr Strainer w/ DoubleDuty™ Test Plug	BI	1	5	\$67.61
<b>COMPONENT ITEMS</b>					
821-2LSQ	4-1/2" Sqr Strainer	BI	1	5	\$59.47
821-2LSR	4-1/2" Rnd Strainer	BI	1	5	\$45.23
821-MHA2	2" ABS Hub - Base & Collar Only	BI	25	25	\$8.13
821-MHP2	2" PVC Hub - Base & Collar Only	BI	25	25	\$8.13
<b>821-TMHA2</b>	2" ABS Hub - Base & Collar Only w/ DoubleDuty™ Test Plug	BI	25	25	\$8.13
<b>821-TMHP2</b>	2" PVC Hub - Base & Collar Only w/ DoubleDuty™ Test Plug	BI	25	25	\$8.13
<b>ACCESSORIES</b>					
821-EX2	Threaded Extension Adapter - 2-3/8" Min - 4-3/4" Max	BI	1	10	\$4.94
821-H	Hair Catcher	B	10	100	\$0.75
821-T2P	PVC Hub - 4-1/4" Rnd Strainer w/ DoubleDuty™ Test Plug	BI	1	10	\$13.65
835-2	Trapshield™ For 2" Drain Outlet	BI	1	50	\$56.31

**Deluxe Oil-Rubbed Bronze Finish Ring & Strainer**

**2" PVC/ABS - Sch.40 Hub Connection**

Item Number	Item Description	Pkg Type	Min Qty	Case Qty	Price
<b>ROUND RING &amp; STRAINER</b>					
821-200ARBR	ABS Hub - 4-1/2" Rnd Strainer	Bl	5	5	\$96.07
821-200PRBR	PVC Hub - 4-1/2" Rnd Strainer	Bl	5	5	\$96.07
821-T200ARBR	ABS Hub - 4-1/2" Rnd Strainer w/ DoubleDuty™ Test Plug	Bl	1	5	\$96.07
821-T200PRBR	PVC Hub - 4-1/2" Rnd Strainer w/ DoubleDuty™ Test Plug	Bl	1	5	\$96.07
<b>SQUARE RING &amp; STRAINER</b>					
821-200ARBQ	ABS Hub - 4-1/2" Sqr Strainer	Bl	5	5	\$110.29
821-200PRBQ	PVC Hub - 4-1/2" Sqr Strainer	Bl	5	5	\$110.29
821-T200ARBQ	ABS Hub - 4-1/2" Sqr Strainer w/ DoubleDuty™ Test Plug	Bl	1	5	\$110.29
821-T200PRBQ	PVC Hub - 4-1/2" Sqr Strainer w/ DoubleDuty™ Test Plug	Bl	1	5	\$110.29
<b>COMPONENT ITEMS</b>					
821-2LRBQ	4-1/2" Sqr Strainer	Bl	1	5	\$102.15
821-2LRBR	4-1/2" Rnd Strainer	Bl	1	5	\$87.93
821-MHA2	2" ABS Hub - Base & Collar Only	Bl	25	25	\$8.13
821-MHP2	2" PVC Hub - Base & Collar Only	Bl	25	25	\$8.13
<b>821-TMHA2</b>	2" ABS Hub - Base & Collar Only w/ DoubleDuty™ Test Plug	Bl	25	25	\$8.13
<b>821-TMHP2</b>	2" PVC Hub - Base & Collar Only w/ DoubleDuty™ Test Plug	Bl	25	25	\$8.13
<b>ACCESSORIES</b>					
821-EX2	Threaded Extension Adapter - 2-3/8" Min - 4-3/4" Max	Bl	1	10	\$4.94
821-H	Hair Catcher	B	10	100	\$0.75
821-TP	Test Plug For 821 Shower Drain	Bl	10	10	\$3.55
835-2	Trapshield™ For 2" Drain Outlet	Bl	1	50	\$56.31



821-200PRBR



821-T200ARBQ

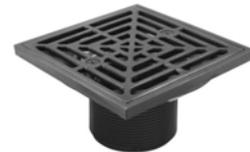

821-2LRBQ



821-EX2

**Grid-Pattern Head & Strainer**

**2" PVC/ABS - Sch.40 Hub Connection**

Item Number	Item Description	Pkg Type	Min Qty	Case Qty	Price
<b>CHROME-PLATED FINISH</b>					
821-2AQCP	ABS Hub - 4-1/8" Sqr Strainer	Bl	5	5	\$56.92
821-2PQCP	PVC Hub - 4-1/8" Sqr Strainer	Bl	5	5	\$56.92
821-T2ACP	ABS Hub - 4-1/8" Rnd Strainer w/ DoubleDuty™ Test Plug	Bl	1	5	\$49.81
821-T2AQCP	ABS Hub - 4-1/8" Sqr Strainer w/ DoubleDuty™ Test Plug	Bl	1	5	\$56.92
821-T2PCP	PVC Hub - 4-1/8" Rnd Strainer w/ DoubleDuty™ Test Plug	Bl	1	5	\$49.81
821-T2PQCP	PVC Hub - 4-1/8" Sqr Strainer w/ DoubleDuty™ Test Plug	Bl	1	5	\$56.92
<b>OIL-RUBBED BRONZE FINISH</b>					
821-2AQRB	ABS Hub - 4-1/8" Sqr Strainer	Bl	5	5	\$85.38
821-2PQRB	PVC Hub - 4-1/8" Sqr Strainer	Bl	1	5	\$85.38
<b>821-T2AQRB</b>	ABS Hub - 4-1/8" Sqr Strainer w/ DoubleDuty™ Test Plug	Bl	1	5	\$85.38
821-T2PQRB	PVC Hub - 4-1/8" Sqr Strainer w/ DoubleDuty™ Test Plug	Bl	1	5	\$85.38



821-2ACP



821-2PQRB

Supply

Drainage

Support

Specialties

Appendix



821-HCP



821-EX2



821-2AT5A



821-2PTQ



821-2LTQ

## Grid-Pattern Head & Strainer (Cont)

### 2" PVC/ABS - Sch.40 Hub Connection

Item Number	Item Description	Pkg Type	Min Qty	Case Qty	Price
<b>COMPONENT ITEMS</b>					
821-2LQRB	4-1/8" Sqr Strainer	BI	1	5	\$77.24
821-HQCP	4-1/8" Sqr Strainer	BI	1	5	\$48.78
821-MHA2	2" ABS Hub - Base & Collar Only	BI	25	25	\$8.13
821-MHP2	2" PVC Hub - Base & Collar Only	BI	25	25	\$8.13
<b>821-TMHA2</b>	2" ABS Hub - Base & Collar Only w/ DoubleDuty™ Test Plug	BI	25	25	\$8.13
<b>821-TMHP2</b>	2" PVC Hub - Base & Collar Only w/ DoubleDuty™ Test Plug	BI	25	25	\$8.13
<b>ACCESSORIES</b>					
821-EX2	Threaded Extension Adapter - 2-3/8" Min - 4-3/4" Max	BI	1	10	\$4.94
821-TP	Test Plug For 821 Shower Drain	BI	10	10	\$3.55
835-2	Trapshield™ For 2" Drain Outlet	BI	1	50	\$56.31

## Tile-Insert Strainer

### 2" PVC/ABS - Sch.40 Hub Connection

Item Number	Item Description	Pkg Type	Min Qty	Case Qty	Price
<b>ABS HEAD</b>					
821-2AT4A	ABS Hub - 4" Head, Stainless Tile-In Tray	BI	1	5	\$64.49
821-2AT5A	ABS Hub - 5" Head, Stainless Tile-In Tray	BI	1	5	\$74.17
821-2PT4A	PVC Hub - 4" Head, Stainless Tile-In Tray	BI	1	5	\$64.49
821-2PT5A	PVC Hub - 5" Head, Stainless Tile-In Tray	BI	1	5	\$74.17
821-T2AT4A	ABS Hub - 4" Head, Stainless Tile-In Tray w/ DoubleDuty™ Test Plug	BI	1	5	\$64.49
821-T2AT5A	ABS Hub - 5" Head, Stainless Tile-In Tray w/ DoubleDuty™ Test Plug	BI	1	5	\$74.17
821-T2PT4A	PVC Hub - 4" Head, Stainless Tile-In Tray w/ DoubleDuty™ Test Plug	BI	1	5	\$64.49
821-T2PT5A	PVC Hub - 5" Head, Stainless Tile-In Tray w/ DoubleDuty™ Test Plug	BI	1	5	\$74.17
<b>STAINLESS STEEL HEAD</b>					
821-2ATQ	ABS Hub - 5" Head, Stainless Tile-In Tray	BI	1	1	\$107.45
821-2PTQ	PVC Hub - 5" Head, Stainless Tile-In Tray	BI	1	1	\$107.45
821-T2ATQ	ABS Hub - 5" Head, Stainless Tile-In Tray w/ DoubleDuty™ Test Plug	BI	1	1	\$107.45
821-T2PTQ	PVC Hub - 5" Head, Stainless Tile-In Tray w/ DoubleDuty™ Test Plug	BI	1	1	\$107.45
<b>COMPONENT ITEMS</b>					
821-2LT4A	4" ABS Head, Stainless Tile-In Tray	BI	1	4	\$56.35
821-2LT5A	5" ABS Head, Stainless Tile-In Tray	BI	1	10	\$65.62
821-2LTQ	5" Stainless Steel Head, Stainless Tile-In Tray	BI	1	20	\$99.31
821-MHA2	2" ABS Hub - Base & Collar Only	BI	25	25	\$8.13
821-MHP2	2" PVC Hub - Base & Collar Only	BI	25	25	\$8.13
<b>821-TMHA2</b>	2" ABS Hub - Base & Collar Only w/ DoubleDuty™ Test Plug	BI	25	25	\$8.13
<b>821-TMHP2</b>	2" PVC Hub - Base & Collar Only w/ DoubleDuty™ Test Plug	BI	25	25	\$8.13

**Tile-Insert Strainer (Cont)**

**2" PVC/ABS - Sch.40 Hub Connection**

Item Number	Item Description	Pkg Type	Min Qty	Case Qty	Price
<b>ACCESSORIES</b>					
821-EX2	Threaded Extension Adapter - 2-3/8" Min - 4-3/4" Max	BI	1	10	\$4.94
821-H	Hair Catcher	B	10	100	\$0.75
821-TP	Test Plug For 821 Shower Drain	BI	10	10	\$3.55
835-2	Trapshield™ For 2" Drain Outlet	BI	1	50	\$56.31



821-EX2

**Adjustable Slab Shower Drain**

**2" PVC Sch. 40 Hub Connection**

Item Number	Item Description	Pkg Type	Min Qty	Case Qty	Price
<b>SCREW-ON STAINLESS STEEL STRAINER</b>					
820-2P	4-1/4" Stnls Steel Rnd Strainer	BI	20	20	\$9.14
820-T2P	4-1/4" Stnls Steel Rnd Strainer w/ DoubleDuty™ Test Plug	BI	10	10	\$9.14
<b>SNAP-IN STAINLESS STEEL STRAINER</b>					
820-27P	4-1/4" Stnls Steel Rnd Strainer	BI	20	20	\$9.14
820-27PQ	4-1/4" Stnls Steel Sqr Strainer	BI	20	20	\$16.75
820-T27P	4-1/4" Stnls Steel Rnd Strainer w/ DoubleDuty™ Test Plug	BI	10	10	\$9.14
820-T27PQ	4-1/4" Stnls Steel Sqr Strainer w/ DoubleDuty™ Test Plug	BI	10	10	\$16.75
<b>DELUXE ROUND RING &amp; STRAINER</b>					
820-20PCR	4-1/2" Chrome Rnd Strainer	BI	6	6	\$60.52
820-20PKR	4-1/2" Nikl Rnd Strainer	BI	6	6	\$59.63
820-20PRBR	4-1/2" Oil-Rubbed Brnz Rnd Strainer	BI	6	6	\$87.62
820-T20PCR	4-1/2" Chrome Rnd Strainer w/ DoubleDuty™ Test Plug	BI	6	6	\$60.52
820-T20PKR	4-1/2" Rnd Strainer w/ DoubleDuty™ Test Plug	BI	6	6	\$59.63
820-T20PRBR	4-1/2" Oil-Rubbed Brnz Rnd Strainer w/ DoubleDuty™ Test Plug	BI	6	6	\$87.62
<b>DELUXE SQUARE RING &amp; STRAINER</b>					
820-20PCQ	4-1/2" Chrome Sqr Strainer	BI	6	6	\$74.06
820-20PKQ	4-1/2" Nikl Sqr Strainer	BI	6	6	\$72.97
820-20PRBQ	4-1/2" Oil-Rubbed Brnz Sqr Strainer	BI	6	6	\$101.18
820-T20PCQ	4-1/2" Chrome Sqr Strainer w/ DoubleDuty™ Test Plug	BI	6	6	\$74.06
820-T20PKQ	4-1/2" Sqr Strainer w/ DoubleDuty™ Test Plug	BI	6	6	\$72.97
820-T20PRBQ	4-1/2" Oil-Rubbed Brnz Sqr Strainer w/ DoubleDuty™ Test Plug	BI	6	6	\$101.18
<b>ACCESSORIES</b>					
821-H	Hair Catcher	B	10	100	\$0.75
821-TP	Test Plug For 821 Shower Drain	BI	10	10	\$3.55
835-2	Trapshield™ For 2" Drain Outlet	BI	1	50	\$56.31



820-27P



820-27PQ



820-20PNQ

Supply

Drainage

Support

Specialties

Appendix

Supply

Drainage

Support

Specialties

Appendix



863-435NQ



863-435CQ



863-435SR



822-S2P

## Large-Capacity Shower Pan Drains

### 3" PVC/ABS Sch. 40 Hub Connection

**Related Products**

Halo™ Drain with Clamping Collar Option p 347

Item Number	Item Description	Pkg Type	Min Qty	Case Qty	Price
<b>NICKEL-BRONZE RING &amp; STRAINER</b>					
863-335NQ	3" ABS Hub - 5-7/8" Sqr Ring & Strainer	BI	1	2	\$111.38
863-335NR	3" ABS Hub - 5-1/2" Rnd Ring & Strainer	BI	1	6	\$90.38
863-435NQ	3" PVC Hub - 5-7/8" Sqr Ring & Strainer	BI	1	2	\$111.38
863-435NR	3" PVC Hub - 5-1/2" Rnd Ring & Strainer	BI	1	6	\$90.38
<b>POLISHED STAINLESS STEEL RING &amp; STRAINER</b>					
863-335CQ	3" ABS Hub - 5-7/8" Sqr Ring & Strainer	BI	1	2	\$126.38
863-335CR	3" ABS Hub - 5-1/2" Rnd Ring & Strainer	BI	1	1	\$104.38
863-435CQ	3" PVC Hub - 5-7/8" Sqr Ring & Strainer	BI	1	2	\$126.38
863-435CR	3" PVC Hub - 5-1/2" Rnd Ring & Strainer	BI	1	6	\$104.38
<b>MATTE STAINLESS STEEL RING &amp; STRAINER</b>					
863-335SQ	3" ABS Hub - 5-7/8" Sqr Ring & Strainer	BI	1	2	\$111.38
863-335SR	3" ABS Hub - 5-1/2" Rnd Ring & Strainer	BI	1	6	\$90.38
863-435SQ	3" PVC Hub - 5-7/8" Sqr Ring & Strainer	BI	1	2	\$111.38
863-435SR	3" PVC Hub - 5-1/2" Rnd Ring & Strainer	BI	1	6	\$90.38
<b>ACCESSORIES</b>					
822-EX3	Ductile Iron Extension Adapter	B	1	1	\$35.33
835-3	Trapshield™ For 3" Drain Outlet	BI	1	25	\$63.36
835-35	Trapshield™ For 3-1/2" Drain Head	BI	1	25	\$63.36

## Halo™ Shower Pan Drain

### 2" PVC/ABS - Sch. 40 Hub Connection

Item Number	Item Description	Pkg Type	Min Qty	Case Qty	Price
<b>DRAINS</b>					
822-S2A	ABS Hub - Debris Cover	BI	6	6	\$33.40
822-S2P	PVC Hub - Debris Cover	BI	6	6	\$33.40

**Cast Iron Shower Drains**

**3-Piece Drain with Grid-Pattern Head & Strainer**

Item Number	Item Description	Pkg Type	Min Qty	Case Qty	Price
<b>2" NO-HUB CONNECTION</b>					
821-2IHCP	4-1/8" Rnd Strainer	BI	1	5	\$94.30
821-2IHQCP	4-1/8" Sqr Strainer	BI	1	5	\$102.10
<b>2" FIP THREAD CONNECTION</b>					
821-2ITCP	4-1/8" Rnd Strainer	BI	1	5	\$98.19
<b>821-2ITQCP</b>	4-1/8" Sqr Strainer	BI	1	5	\$105.99
<b>COMPONENT ITEMS</b>					
821-2IH	2" No-Hub	BI	1	10	\$52.21
821-2IT	2" FIP	BI	1	10	\$51.23
821-HQCP	4-1/8" Sqr Strainer	BI	1	5	\$48.78
<b>ACCESSORIES</b>					
821-EX2	Threaded Extension Adapter - 2-3/8" Min - 4-3/4" Max	BI	1	10	\$4.94
835-2	Trapshield™ For 2" Drain Outlet	BI	1	50	\$56.31



821-2IHCP



821-2ITQCP



821-HCP

**Cast Iron Shower Drains**

**2-Piece Drain with Stamped Stainless Steel Strainer**

Item Number	Item Description	Pkg Type	Min Qty	Case Qty	Price
<b>2" NO-CAULK CONNECTION</b>					
821-2INS	3-1/2" Rnd Strainer	CI	1	4	\$47.55
<b>2" FIP THREAD CONNECTION</b>					
821-2IFS	3-1/2" Rnd Strainer	CI	4	4	\$39.73
<b>ACCESSORIES</b>					
821-HSQ	4" Sqr Stnls Steel Strainer Ring Only	CI	1	10	\$9.30
821-HSR	3-1/2" Rnd Stnls Steel Strainer	CI	1	10	\$10.02



821-2INS



821-2IFS



821-HSQ

Supply

Drainage

Support

Specialties

Appendix

**Stainless Steel Linear Shower Drain**  
**2" PVC/ABS Sch. 40 Hub Connection**



823-TX26SP



823-TX26WP



823-TX26TP

Item Number	Item Description	Pkg Type	Min Qty	Case Qty	Price
<b>STAMPED STAINLESS STEEL STRAINER</b>					
823-TX26SA	ABS Hub - 26" Linear Drain	BI	1	1	\$289.31
823-TX26SP	PVC Hub - 26" Linear Drain	BI	1	1	\$289.31
823-TX30SA	ABS Hub - 30" Linear Drain	BI	1	1	\$311.91
823-TX30SP	PVC Hub - 30" Linear Drain	BI	1	1	\$311.91
823-TX36SA	ABS Hub - 36" Linear Drain	BI	1	1	\$334.50
823-TX36SP	PVC Hub - 36" Linear Drain	BI	1	1	\$334.50
823-TX40SA	ABS Hub - 40" Linear Drain	BI	1	1	\$345.81
823-TX40SP	PVC Hub - 40" Linear Drain	BI	1	1	\$345.81
823-TX48SA	ABS Hub - 48" Linear Drain	BI	1	1	\$366.15
823-TX48SP	PVC Hub - 48" Linear Drain	BI	1	1	\$366.15
823-TX60SA	ABS Hub - 60" Linear Drain	BI	1	1	\$404.57
823-TX60SP	PVC Hub - 60" Linear Drain	BI	1	1	\$404.57
<b>STAINLESS STEEL WEDGEWIRE STRAINER</b>					
823-TX26WA	ABS Hub - 26" Linear Drain	BI	1	1	\$743.61
823-TX26WP	PVC Hub - 26" Linear Drain	BI	1	1	\$743.61
823-TX30WA	ABS Hub - 30" Linear Drain	BI	1	1	\$766.18
823-TX30WP	PVC Hub - 30" Linear Drain	BI	1	1	\$766.18
823-TX36WA	ABS Hub - 36" Linear Drain	BI	1	1	\$845.31
823-TX36WP	PVC Hub - 36" Linear Drain	BI	1	1	\$845.31
823-TX40WA	ABS Hub - 40" Linear Drain	BI	1	1	\$879.18
823-TX40WP	PVC Hub - 40" Linear Drain	BI	1	1	\$879.18
823-TX48WA	ABS Hub - 48" Linear Drain	BI	1	1	\$947.00
823-TX48WP	PVC Hub - 48" Linear Drain	BI	1	1	\$947.00
823-TX60WA	ABS Hub - 60" Linear Drain	BI	1	1	\$1,037.41
823-TX60WP	PVC Hub - 60" Linear Drain	BI	1	1	\$1,037.41
<b>TILE-INSERT STRAINER</b>					
823-TX26TA	ABS Hub - 26" Linear Drain	BI	1	1	\$289.31
823-TX26TP	PVC Hub - 26" Linear Drain	BI	1	1	\$289.31
823-TX30TA	ABS Hub - 30" Linear Drain	BI	1	1	\$311.91
823-TX30TP	PVC Hub - 30" Linear Drain	BI	1	1	\$311.91
823-TX36TA	ABS Hub - 36" Linear Drain	BI	1	1	\$334.50
823-TX36TP	PVC Hub - 36" Linear Drain	BI	1	1	\$334.50
823-TX40TA	ABS Hub - 40" Linear Drain	BI	1	1	\$345.81
823-TX40TP	PVC Hub - 40" Linear Drain	BI	1	1	\$345.81
823-TX48TA	ABS Hub - 48" Linear Drain	BI	1	1	\$366.15
823-TX48TP	PVC Hub - 48" Linear Drain	BI	1	1	\$366.15
823-TX60TA	ABS Hub - 60" Linear Drain	BI	1	1	\$404.57
823-TX60TP	PVC Hub - 60" Linear Drain	BI	1	1	\$404.57
<b>ACCESSORIES</b>					
821-EX2	Threaded Extension Adapter - 2-3/8" Min - 4-3/4" Max	BI	1	10	\$4.94
821-TP	Test Plug For 821 Shower Drain	BI	10	10	\$3.55
835-2	Trapshield™ For 2" Drain Outlet	BI	1	50	\$56.31

Supply

Drainage

Support

Specialties

Appendix



**Site-Adjustable Linear Shower Drain****2" PVC/ABS Sch. 40 Hub Connection**

Item Number	Item Description	Pkg Type	Min Qty	Case Qty	Price
<b>STAMPED STAINLESS STEEL STRAINER</b>					
823-T2A36V	ABS Hub - 36" Linear Drain Kit	BI	1	1	\$276.53
823-T2A72V	ABS Hub - 72" Linear Drain Kit	BI	1	1	\$407.68
823-T2P36V	PVC Hub - 36" Linear Drain Kit	BI	1	1	\$276.53
823-T2P72V	PVC Hub - 72" Linear Drain Kit	BI	1	1	\$407.68
<b>TILE-INSERT STRAINER</b>					
823-T2A36T	ABS Hub - 36" Linear Drain Kit	BI	1	1	\$317.88
823-T2A72T	ABS Hub - 72" Linear Drain Kit	BI	1	1	\$478.59
823-T2P36T	PVC Hub - 36" Linear Drain Kit	BI	1	1	\$317.88
823-T2P72T	PVC Hub - 72" Linear Drain Kit	BI	1	1	\$478.59
<b>ACCESSORIES</b>					
821-EX2	Threaded Extension Adapter - 2-3/8" Min - 4-3/4" Max	BI	1	10	\$4.94
821-TP	Test Plug For 821 Shower Drain	BI	10	10	\$3.55
835-2	Trapshield™ For 2" Drain Outlet	BI	1	50	\$56.31



823-T2A36V

**Low-Profile Linear Shower Drain****2" PVC Sch. 40 Hub Connection**

Item Number	Item Description	Pkg Type	Min Qty	Case Qty	Price
<b>STAMPED STAINLESS STEEL STRAINER</b>					
823-24PSS	24" Channel Length	BI	1	1	\$951.57
823-32PSS	32" Channel Length	BI	1	1	\$1,154.74
823-40PSS	40" Channel Length	BI	1	1	\$1,357.59
823-60PSS	60" Channel Length	BI	1	1	\$1,806.32
<b>TILE-INSERT STRAINER</b>					
823-32PST	32" Channel Length	BI	1	1	\$1,177.84
823-60PST	60" Channel Length	BI	1	1	\$1,842.46



823-24PSS

Supply

Drainage

Support

Specialties

Appendix

Supply

Drainage

Support

Specialties

Appendix



825-20P



825-27A



825-2PFS



827-2B



828-2

## 825 Series - Receptor-Base Style

### 2" PVC/ABS Sch. 40 Hub Connection

Item Number	Item Description	Pkg Type	Min Qty	Case Qty	Price
<b>SCREW-ON STAINLESS STEEL STRAINER</b>					
825-1P	1-1/2" PVC Hub - 4-1/4" Rnd Strainer	BI	20	20	\$11.07
825-20A	2" ABS Hub - 4-1/4" Rnd Strainer	BI	20	20	\$11.07
825-20P	2" PVC Hub - 4-1/4" Rnd Strainer	BI	20	20	\$11.07
825-2A	2" ABS Hub - 4-1/4" Rnd Strainer	BI	20	20	\$9.32
825-2APK	2" ABS Hub - 4-1/4" Rnd Strainer	BI	12	12	\$10.32
825-2P	2" PVC Hub - 4-1/4" Rnd Strainer	BI	20	20	\$9.32
825-2PPK	2" PVC Hub - 4-1/4" Rnd Strainer	CI	12	12	\$10.32
<b>SNAP-IN STAINLESS STEEL STRAINER</b>					
825-17P	1-1/2" PVC Hub - 4-1/4" Rnd Strainer	BI	20	20	\$10.93
825-27A	2" ABS Hub - 4-1/4" Rnd Strainer	BI	20	20	\$9.19
825-27P	2" PVC Hub - 4-1/4" Rnd Strainer	BI	20	20	\$9.19
<b>ACCESSORIES</b>					
821-H	Hair Catcher	B	10	100	\$0.75
835-2	Trapshield™ For 2" Drain Outlet	BI	1	50	\$56.31

## 825 Series - Offset Receptor-Base Style

### 2" PVC/ABS Sch. 40 Hub Connection

Item Number	Item Description	Pkg Type	Min Qty	Case Qty	Price
<b>SCREW-ON STAINLESS STEEL STRAINER</b>					
825-2AFS	2" ABS Hub - 4-1/4" Rnd Strainer	CI	10	10	\$14.86
825-2PFS	2" PVC Hub - 4-1/4" Rnd Strainer	CI	10	10	\$14.86

## No-Caulk Connection

### 2" No-Caulk Connection

Item Number	Item Description	Pkg Type	Min Qty	Case Qty	Price
<b>BRASS BODY - STAINLESS STEEL STRAINER</b>					
827-2B	2" No-Caulk Conn. - 4-1/4" Rnd Strainer	CI	20	20	\$31.73
<b>POLYPRO BODY - STAINLESS STEEL STRAINER</b>					
828-2	2" No-Caulk Conn. - 4-1/4" Rnd Strainer	BI	20	20	\$11.97
828-2PK	2" No-Caulk Conn. - 4-1/4" Rnd Strainer	CI	10	10	\$12.97
<b>ACCESSORIES</b>					
821-H	Hair Catcher	B	10	100	\$0.75
827-2BG	Elastomer Comp. Gasket	B	1	100	\$2.27
828-GC	Elastomer Compression Gasket For Copper Pipe	B	1	10	\$2.53
835-2	Trapshield™ For 2" Drain Outlet	BI	1	50	\$56.31

### JackRabbit™ Outer-Locknut Style

#### 2" No-Caulk Connection

Item Number	Item Description	Pkg Type	Min Qty	Case Qty	Price
<b>BRASS BODY - STAINLESS STEEL STRAINER</b>					
827-2J	2" Brass No-Caulk Conn. - 4-1/4" Rnd Strainer	Cl	1	20	\$54.63
<b>ACCESSORIES</b>					
821-H	Hair Catcher	B	10	100	\$0.75
827-2BG	Elastomer Comp. Gasket	B	1	100	\$2.27
828-GC	Elastomer Compression Gasket For Copper Pipe	B	1	10	\$2.53
835-2	Trapshield™ For 2" Drain Outlet	Bl	1	50	\$56.31



827-2J

### 826 Series - Outer-Locknut Style

#### 2" Glue-or-Gasket Connection

Item Number	Item Description	Pkg Type	Min Qty	Case Qty	Price
<b>2" GLUE-OR-GASKET CONNECTION</b>					
826-2A	2" ABS Hub - 4-1/4" Rnd Strainer	Bl	1	20	\$21.90
826-2P	2" PVC Hub - 4-1/4" Rnd Strainer	Bl	1	20	\$21.90
826-2PPK	2" PVC Hub - 4-1/4" Rnd Strainer	Cl	10	10	\$22.90
<b>ACCESSORIES</b>					
821-H	Hair Catcher	B	10	100	\$0.75
835-2	Trapshield™ For 2" Drain Outlet	Bl	1	50	\$56.31



826-2P

Supply

Drainage

Support

Specialties

Appendix

Supply

Drainage

Support

Specialties

Appendix



819-2P

### Freestanding Tub Drain

#### 2" PVC/ABS - Sch.40 Hub Connection

Item Number	Item Description	Pkg Type	Min Qty	Case Qty	Price
819-2A	ABS Hub - Tub Drain	BI	6	6	\$59.99
819-2P	PVC Hub - Tub Drain	BI	6	6	\$59.99

**Snap-In Strainers**

**Stamped (19 ga)**

Item Number	Item Description	Pkg Type	Min Qty	Case Qty	Price
<b>STAINLESS STEEL</b>					
827-2S	4-1/4" Rnd Snap-In	Bl	1	100	\$3.47
827-2SPK1	4-1/4" Rnd Snap-In, Cut Case	Cl	10	10	\$4.97
827-2SQPK1	4-1/4" Sqr Snap-In, Cut Case	Cl	1	5	\$8.88
<b>OIL-RUBBED BRONZE FINISH</b>					
827-2RBPk2	4-1/4" Rnd Snap-In	Bl	5	5	\$16.80
827-2RBQ	4-1/4" Sqr Snap-In	Bl	1	100	\$22.79
827-2RBQPK1	4-1/4" Sqr Snap-In, Cut Case	Cl	1	5	\$23.79
<b>SATIN NICKEL FINISH</b>					
827-2SNPK2	4-1/4" Rnd Snap-In	Bl	5	5	\$17.31
827-2SNQPK1	4-1/4" Sqr Snap-In, Cut Case	Cl	1	5	\$20.86
<b>MATTE BLACK FINISH</b>					
827-2SMQPK1	4-1/4" Sqr Snap-In	Cl	1	5	\$22.79
827-2SMRPK1	4-1/4" Rnd Snap-In	Cl	5	5	\$18.21
<b>WHITE ENAMEL FINISH</b>					
827-2SWPK1	4-1/4" Rnd Snap-In, Cut Case	Cl	1	5	\$13.37
<b>POLISHED BRASS FINISH</b>					
827-2SPPK1	4-1/4" Rnd Snap-In, Cut Case	Cl	1	5	\$13.24



827-2S

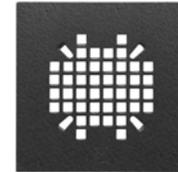

827-2RBQ

**Screw-On Strainers**

**Stamped (19 ga)**

Item Number	Item Description	Pkg Type	Min Qty	Case Qty	Price
<b>STAINLESS STEEL</b>					
821-2S	4-1/4" Diameter	Bl	1	100	\$4.24
821-2SPK1	4-1/4" Diameter	Cl	10	10	\$5.74



821-2S

**Cast Ring & Strainers**

**Round Pattern**

Item Number	Item Description	Pkg Type	Min Qty	Case Qty	Price
<b>CHROME FINISH</b>					
821-2SCRPK2	4-1/2" Diameter	Bl	1	50	\$55.22
<b>POLISHED STAINLESS STEEL</b>					
821-2SCRPK1	4-1/2" Diameter	Bl	1	10	\$55.23
<b>SATIN NICKEL FINISH</b>					
821-2SKRPK1	4-1/2" Diameter	Bl	6	6	\$55.62
821-2SKRPK2	4-1/2" Diameter	Bl	1	50	\$55.62
<b>OIL-RUBBED BRONZE FINISH</b>					
821-2SRBRPK1	4-1/2" Diameter	Cl	6	6	\$83.86
821-2SRBRPK2	4-1/2" Diameter	Bl	1	50	\$83.86
<b>MATTE BLACK FINISH</b>					
821-2SMRPK2	4-1/2" Diameter	Cl	1	5	\$83.86



821-2SKRPK1



821-2SRBRPK1

Supply

Drainage

Support

Specialties

Appendix

**Cast Ring & Strainers (Cont)**

**Round Pattern**

Item Number	Item Description	Pkg Type	Min Qty	Case Qty	Price
<b>MATTE STAINLESS STEEL</b>					
821-2SSRPK1	4-1/2" Diameter	BI	1	10	\$40.88
<b>NICKEL-BRONZE</b>					
821-2SNRPK1	4-1/2" Diameter	CI	6	6	\$40.88

**Cast Ring & Strainers**

**Square Pattern**

Item Number	Item Description	Pkg Type	Min Qty	Case Qty	Price
<b>CHROME FINISH</b>					
821-2SCQPK2	4-1/2" Diameter	BI	1	50	\$69.54
<b>POLISHED STAINLESS STEEL</b>					
821-2SCQPK1	4-1/2" Diameter	BI	1	10	\$69.53
<b>SATIN NICKEL FINISH</b>					
821-2SKQPK1	4-1/2" Diameter	BI	1	10	\$69.53
821-2SKQPK2	4-1/2" Diameter	BI	1	50	\$69.53
<b>OIL-RUBBED BRONZE FINISH</b>					
821-2SRBQPK1	4-1/2" Diameter	BI	1	10	\$98.21
821-2SRBQPK2	4-1/2" Diameter	BI	1	50	\$98.21
<b>MATTE BLACK FINISH</b>					
821-2SMQPK2	4-1/2" Diameter	CI	5	5	\$98.21
<b>MATTE STAINLESS STEEL</b>					
821-2SSQPK1	4-1/2" Diameter	CI	1	10	\$54.79
<b>NICKEL-BRONZE</b>					
821-2SNQPK1	4-1/2" Diameter	CI	1	10	\$55.23



821-2SKQPK1



821-2SRBQPK1

Supply

Drainage

Support

Specialties

Appendix

# Residential Floor Drains

**WeldOne™ Integral Trap Drains**

**QuadDrain™ General-Purpose Drains**

**Pipe Strainers**

**Accessories**

Floor drains for residential basements and mechanical rooms, as well as a variety of models for garages and other applications available with PVC and ABS connections.

Drains available with durable yet economical poly strainers, or cast ring/strainers for finished areas.







**WeldOne™**

**2" PVC/ABS Sch. 40 Hub Connection**

Item Number	Item Description	Pkg Type	Min Qty	Case Qty	Price
<b>POLYPRO STRAINER</b>					
800-A	ABS Hub - 6-1/2" Rnd Strainer	BI	12	12	\$29.69
800-ABW	ABS Hub - 6-1/2" Rnd Strainer w/ Backwater Device	BI	12	12	\$39.60
800-APK	ABS Hub - 6-1/2" Rnd Strainer	CI	3	3	\$31.19
800-P	PVC Hub - 6-1/2" Rnd Strainer	BI	12	12	\$29.69
800-PBW	PVC Hub - 6-1/2" Rnd Strainer w/ Backwater Device	BI	12	12	\$39.60
800-PPK	PVC Hub - 6-1/2" Rnd Strainer	BI	3	3	\$31.19
<b>ACCESSORIES</b>					
802-7	Polypro Backwater Device For 2" FIP Threads	CI	12	12	\$8.41



800-P



802-7

Supply

Drainage

Support

Specialties

Appendix

Supply

Drainage

Support

Specialties

Appendix



841-2P



841-2PNQ



841-2PSR



841-29P



841-29PNR

**QuadDrain™**

**2x3 PVC/ABS Sch. 40 Hub**

Item Number	Item Description	Pkg Type	Min Qty	Case Qty	Price
<b>POLYPRO STRAINER</b>					
841-2A	2" ABS Hub - 6-1/2" Rnd Strainer	BI	12	12	\$15.92
841-2APK	2" ABS Hub - 6-1/2" Rnd Strainer	CI	6	6	\$16.92
841-2P	2" PVC Hub - 6-1/2" Rnd Strainer	BI	12	12	\$15.92
841-2PPK	2" PVC Hub - 6-1/2" Rnd Strainer	BI	6	6	\$16.92
<b>NICKEL-BRONZE RING &amp; STRAINER</b>					
<b>841-2ANQ</b>	2" ABS Hub - 7" Sqr Ring & Strainer	BI	1	1	\$112.20
<b>841-2ANR</b>	2" ABS Hub - 6-1/2" Rnd Ring & Strainer	BI	1	1	\$75.99
<b>841-2PNQ</b>	2" PVC Hub - 7" Sqr Ring & Strainer	BI	1	1	\$112.20
841-2PNR	2" PVC Hub - 6-1/2" Rnd Ring & Strainer	BI	1	6	\$75.99
<b>STAINLESS STEEL RING &amp; STRAINER</b>					
<b>841-2ASQ</b>	2" ABS Hub - 7" Sqr Ring & Strainer	BI	1	1	\$117.29
<b>841-2ASR</b>	2" ABS Hub - 6-1/2" Rnd Ring & Strainer	BI	1	1	\$79.46
<b>841-2PSQ</b>	2" PVC Hub - 7" Sqr Ring & Strainer	BI	1	1	\$117.29
<b>841-2PSR</b>	2" PVC Hub - 6-1/2" Rnd Ring & Strainer	BI	1	1	\$79.46
<b>DUCTILE IRON RING &amp; STRAINER</b>					
<b>841-2PIR</b>	2" PVC Hub - 6-1/2" Rnd Ring & Strainer	BI	1	1	\$49.20
<b>ACCESSORIES</b>					
835-2	Trapshield™ For 2" Drain Outlet	BI	1	50	\$56.31

**QuadDrain™**

**Full-Slip Hub Connection**

Item Number	Item Description	Pkg Type	Min Qty	Case Qty	Price
<b>POLYPRO STRAINER</b>					
841-29P	2" PVC Hub - 6-1/2" Rnd Strainer	BI	12	12	\$15.92
841-39P	3" PVC Hub - 6-1/2" Rnd Strainer	BI	12	12	\$15.92
<b>NICKEL-BRONZE RING &amp; STRAINER</b>					
841-29PNR	2" PVC Hub - 6-1/2" Rnd Ring & Strainer	BI	1	2	\$75.99
<b>ACCESSORIES</b>					
835-2	Trapshield™ For 2" Drain Outlet	BI	1	50	\$56.31
835-3	Trapshield™ For 3" Drain Outlet	BI	1	25	\$63.36

**840 Series Floor Drains**

**PVC/ABS Sch. 40 Hub Connection**

Item Number	Item Description	Pkg Type	Min Qty	Case Qty	Price
<b>SCREW-ON STAINLESS STEEL STRAINER</b>					
840-2A	2" ABS Hub - 4-1/4" Rnd Strainer	Bl	1	20	\$8.25
840-2APK	2" ABS Hub - 4-1/4" Rnd Strainer	Cl	10	10	\$9.25
840-2P	2" PVC Hub - 4-1/4" Rnd Strainer	Bl	20	20	\$8.25
840-2PPK	2" PVC Hub - 4-1/4" Rnd Strainer	Cl	10	10	\$9.25
840-3A	3" ABS Hub - 4-1/4" Rnd Strainer	Bl	1	20	\$11.98
840-3APK	3" ABS Hub - 4-1/4" Rnd Strainer	Cl	10	10	\$12.98
840-3P	3" PVC Hub - 4-1/4" Rnd Strainer	Bl	20	20	\$11.98
840-3PPK	3" PVC Hub - 4-1/4" Rnd Strainer	Cl	10	10	\$12.98
<b>SNAP-IN STAINLESS STEEL STRAINER</b>					
840-27A	2" ABS Hub - 4-1/4" Rnd Strainer	Bl	20	20	\$8.25
840-27P	2" PVC Hub - 4-1/4" Rnd Strainer	Bl	20	20	\$8.25
<b>NICKEL-BRONZE RING &amp; STRAINER</b>					
840-20ANR	2" ABS Hub - 4-1/2" Rnd Ring & Strainer	Bl	1	10	\$47.07
<b>840-20PNQ</b>	2" PVC Hub - 4-1/2" Sqr Ring & Strainer	Bl	1	1	\$61.52
840-20PNR	2" PVC Hub - 4-1/2" Rnd Ring & Strainer	Bl	1	10	\$47.07
840-30ANR	3" ABS Hub - 4-1/2" Rnd Ring & Strainer	Bl	1	10	\$50.67
840-30PNR	3" PVC Hub - 4-1/2" Rnd Ring & Strainer	Bl	1	10	\$50.67
<b>STAINLESS STEEL RING &amp; STRAINER</b>					
<b>840-20PCQ</b>	2" PVC Hub - 4-1/2" Sqr Ring & Strainer	Bl	1	5	\$75.99
<b>840-20PSQ</b>	2" PVC Hub - 4-1/2" Sqr Ring & Strainer	Bl	1	1	\$61.52
<b>OIL-RUBBED BRONZE FINISH RING &amp; STRAINER</b>					
<b>840-20PRBQ</b>	2" PVC Hub - 4-1/2" Sqr Ring & Strainer	Bl	1	5	\$104.97
<b>ACCESSORIES</b>					
835-2	Trapshield™ For 2" Drain Outlet	Bl	1	50	\$56.31
835-3	Trapshield™ For 3" Drain Outlet	Bl	1	25	\$63.36



840-2A



840-27P



840-20ANR

**Bell-Trap Floor Drains**

**PVC/ABS Sch. 40 Hub Connection**

Item Number	Item Description	Pkg Type	Min Qty	Case Qty	Price
866-2PPK	1-1/2" Hub/Inside 2" PVC - 6" Diameter Top	Cl	5	5	\$12.93
866-34PPK	3" Hub/Inside 4" PVC - 9" Diameter Top	Cl	5	5	\$27.68



866-34PPK

**Bell-Trap Floor Drains**

**Cast Iron No-Hub Connection**

Item Number	Item Description	Pkg Type	Min Qty	Case Qty	Price
866-2I	2" No-Hub - 5-3/4" Diameter Top	Bl	1	4	\$46.71
866-3I	3" No-Hub - 9" Diameter Top	Bl	1	4	\$76.42



866-2I

Supply

Drainage

Support

Specialties

Appendix



845-3PPK



845-84PN



847-2



847-7

### Inside Pipe Drain

Item Number	Item Description	Pkg Type	Min Qty	Case Qty	Price
<b>ONE-PIECE ABS</b>					
845-2APK	Inside 2" ABS - 2-3/8" Rnd Strainer	CI	10	10	\$2.23
845-2PPK	Inside 2" PVC - 2-3/8" Rnd Strainer	CI	10	10	\$2.23
845-3APK	Inside 3" ABS - 3-1/2" Rnd Strainer	CI	10	10	\$2.81
845-3PPK	Inside 3" PVC - 3-1/2" Rnd Strainer	CI	10	10	\$2.81
845-4APK	Inside 4" ABS - 4-1/2" Rnd Strainer	CI	10	10	\$3.81
845-4PPK	Inside 4" PVC - 4-1/2" Rnd Strainer	CI	10	10	\$3.81
<b>NICKEL-BRONZE STRAINER</b>					
845-83PN	Inside 3" PVC - 3-1/2" Rnd Nickel-bronze Strainer	CI	10	10	\$36.50
845-84PN	Inside 4" PVC - 4-1/2" Rnd Nickel-bronze Strainer	CI	10	10	\$51.50

### Gripper™

#### Stainless Steel Pipe Strainers

Item Number	Item Description	Pkg Type	Min Qty	Case Qty	Price
847-2	Fits 2" Pipe	B	20	20	\$7.61
847-2PK1	Fits 2" Pipe, Clamshell	CI	5	5	\$9.11
847-3	Fits 3" Pipe	B	20	20	\$8.02
847-3PK1	Fits 3" Pipe, Clamshell	CI	10	10	\$9.52
847-4	Fits 4" Pipe	B	10	10	\$8.42
847-4PK1	Fits 4" Pipe, Clamshell	CI	10	10	\$9.92

### Replacelt™

#### Adjustable Stainless Steel Replacement Strainer

Item Number	Item Description	Pkg Type	Min Qty	Case Qty	Price
847-7	7-1/4" Diameter, Clamshell	CI	10	10	\$40.42
847-7B	7-1/4" Diameter	BI	20	20	\$33.23
847-9	9-1/4" Diameter	BI	1	10	\$80.04

## Cast Iron Floor Drains

## Residential Floor Drains

### Philadelphia Style Fresh Air Vent

#### Cast Iron Inside-Caulk Connection

Item Number	Item Description	Pkg Type	Min Qty	Case Qty	Price
869-V4	4"	BI	1	4	\$49.02



869-V4

### Pittsburgh Style Floor Drain

#### Cast Iron Inside-Caulk Connection

Item Number	Item Description	Pkg Type	Min Qty	Case Qty	Price
844-04IQ	4"	BI	1	4	\$45.59



844-04IQ

### St. Louis Style Floor Drain

#### Cast Iron Inside-Caulk Connection

Item Number	Item Description	Pkg Type	Min Qty	Case Qty	Price
844-02SL	2"	BI	1	1	\$16.27
844-04SL	4"	BI	1	1	\$49.20
844-0SL	3"	BI	1	1	\$34.05



844-02SL

Supply

Drainage

Support

Specialties

Appendix



801-A2

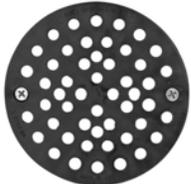

801-A



801-DR2

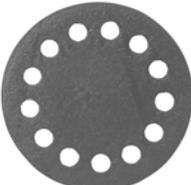

866-S2I



866-3S

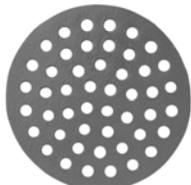

844-02G

### Strainers for Weld One / Quad Drain

Item Number	Item Description	Pkg Type	Min Qty	Case Qty	Price
<b>NEW PATTERN</b>					
801-A2	6-1/8" Diameter, Rnd, Black Polypro	BI	1	25	\$6.82
801-P2	6-1/8" Diameter, Rnd, White Polypro	BI	1	25	\$6.82
801-P2PK	6-1/8" Diameter, Rnd, White Polypro	BI	10	10	\$7.07
801-PG2	6-1/8" Diameter, Rnd, Gray Polypro	BI	1	25	\$6.82
<b>CLASSIC PATTERN</b>					
801-A	6-3/4" Diameter, Rnd, Black Poly	BI	1	25	\$6.82
801-APK	6-3/4" Diameter, Rnd, Black Polypro	CI	10	10	\$7.07
801-P	6-3/4" Diameter, Rnd, White Polypro	BI	1	25	\$6.82
801-PPK	6-3/4" Diameter, Rnd, White Polypro	CI	10	10	\$7.07
<b>CAST METAL RING &amp; STRAINER</b>					
801-DR2	6-1/2" Diameter, Rnd, Ductile Iron	BI	1	10	\$32.59
801-NQ2	7" Diameter, Sqr, Nikl-Brnz	BI	1	10	\$103.22
801-NR2	6-1/2" Diameter, Rnd, Nikl-Brnz	BI	1	10	\$63.99
<b>801-SQ2</b>	7" Diameter, Sqr, Stnls Steel	BI	1	10	\$103.22
801-SR2	6-1/2" Diameter, Rnd, Stnls Steel	BI	1	10	\$63.99

### Strainers for Bell Trap Drain

Item Number	Item Description	Pkg Type	Min Qty	Case Qty	Price
<b>STRAINERS FOR 6X6 DRAINS</b>					
866-2S	4-9/16" Diameter, Rnd, PVC	BI	1	20	\$9.24
866-S2I	4-7/8" Diameter, Rnd, Cast Iron	BI	1	10	\$12.20
<b>STRAINERS FOR 9X9 DRAINS</b>					
866-3S	7-3/4" Diameter, Rnd, PVC	BI	1	20	\$13.29
866-S3I	6-3/4" Diameter, Rnd, Cast Iron	BI	1	10	\$20.31

### Strainers for City-Style Drains

Item Number	Item Description	Pkg Type	Min Qty	Case Qty	Price
<b>PITTSBURGH STYLE</b>					
844-S4	6-3/4" Diameter, Rnd Epoxy Coated Cast Iron	BI	1	40	\$10.51
<b>ST. LOUIS STYLE</b>					
844-02G	4-7/16" Diameter, Rnd Epoxy Coated Cast Iron	BI	1	10	\$7.97
844-04G	8-5/8" Diameter, Rnd Epoxy Coated Cast Iron	BI	1	10	\$22.46
844-0G	6-3/8" Diameter, Rnd Epoxy Coated Cast Iron	BI	1	10	\$10.88

**Strainers for City-Style Drains (Cont)**

Item Number	Item Description	Pkg Type	Min Qty	Case Qty	Price
<b>PHILADELPHIA STYLE</b>					
869-SV4	6" Diameter, Rnd Epoxy Coated Cast Iron w/ Set Screw	Bl	10	10	\$22.23



869-SV4

**General-Purpose Cast Iron Strainers**

Item Number	Item Description	Pkg Type	Min Qty	Case Qty	Price
846-S11PK	6-5/8" Diameter	Cl	3	3	\$14.14
846-S13PK	6-7/8" Diameter	Cl	3	3	\$15.29
846-S15PK	7" Diameter	Cl	3	3	\$15.71
846-S17PK	8" Diameter	Cl	3	3	\$20.01
846-S19PK	8-7/8" Diameter	Cl	3	3	\$27.47
846-S1PK	4-3/8" Diameter	Cl	3	3	\$7.06
846-S3PK	5" Diameter	Cl	3	3	\$7.46
846-S5PK	6" Diameter	Cl	3	3	\$11.38
846-S7PK	6-1/4" Diameter	Cl	3	3	\$12.17
846-S9PK	6-1/2" Diameter	Cl	3	3	\$13.34



846-S1PK

Supply

Drainage

Support

Specialties

Appendix





# Closet Flanges

**Knockout Closet Flanges**

**Open Closet Flanges**

**Push-In Closet Flanges**

**Offset Closet Flanges**

**Specialty Flanges**

**Repair Rings**



Sioux Chief offers one of the most complete and innovative lines of closet flanges in the industry with models available to suit almost any application.



**883-PT**  
Page 443



**884-PTM**  
Page 443



**886-P**  
Page 444



**887-PM**  
Page 444



**886-GP**  
Page 445



**886-GI**  
Page 445



**889-POM**  
Page 446



**889-45PM**  
Page 446



**890-I42**  
Page 447



**868-7P**  
Page 447



**886-MR**  
Page 448



**886-R**  
Page 448



**886-ER**  
Page 448

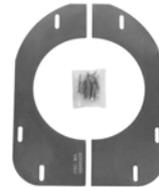

**490-11322**  
Page 449

**TKO™**

**PVC/ABS Sch. 40 Connection**

**Related Products**

Closet Specialties p 631

Item Number	Item Description	Pkg Type	Min Qty	Case Qty	Price
<b>ONE-PIECE PLASTIC RING</b>					
883-AT	3" Hub/Inside 4", ABS, Flush To Floor	BI	25	25	\$4.67
883-ATPK	3" Hub/Inside 4", ABS, Flush To Floor	CI	8	8	\$5.17
883-PT	3" Hub/Inside 4", PVC, Flush To Floor	BI	25	25	\$4.67
883-PTPK	3" Hub/Inside 4", PVC, Flush To Floor	CI	8	8	\$5.17
886-PT30	3" Sch 30 Hub, PVC	BI	25	25	\$7.32
<b>STAINLESS STEEL SWIVEL RING</b>					
884-ATM	3" Hub/Inside 4", ABS, Flush To Floor, 2-1/2" Tailpiece	BI	24	24	\$9.66
884-ATMPK	3" Hub/Inside 4", ABS, Flush To Floor, 2-1/2" Tailpiece	CI	8	8	\$10.16
884-PTM	3" Hub/Inside 4", PVC, Flush To Floor, 2-1/2" Tailpiece	BI	24	24	\$9.66
884-PTMPK	3" Hub/Inside 4", PVC, Flush To Floor, 2-1/2" Tailpiece	CI	8	8	\$10.16
886-4ATM	4" Hub, ABS, Flush To Floor	BI	25	25	\$12.97
886-4ATMPK	4" Hub, ABS, Flush To Floor	CI	8	8	\$13.47
886-4ATMSPK	4" Spigot, ABS, Flush To Floor	CI	8	8	\$13.47
886-4PTM	4" Hub, PVC, Flush To Floor	BI	25	25	\$12.97
886-4PTMPK	4" Hub, PVC, Flush To Floor	CI	8	8	\$13.47
886-4PTMSPK	4" Spigot, PVC, Flush To Floor	CI	8	8	\$13.47
886-ATMS	3" Spigot, ABS	BI	25	25	\$14.83
886-ATMSPK	3" Spigot, ABS	CI	8	8	\$15.33
886-PTM30	3" Sch 30 Hub, PVC	BI	25	25	\$12.24
886-PTMS	3" Spigot, PVC	BI	25	25	\$14.83
886-PTMSPK	3" Spigot, PVC	CI	8	8	\$15.33
888-ATM	Inside 3", ABS	BI	25	25	\$9.20
888-ATMPK	Inside 3", ABS	CI	8	8	\$9.70
888-PTM	Inside 3", PVC	BI	25	25	\$9.20
888-PTMPK	Inside 3", PVC	CI	8	8	\$9.70



883-AT



884-PTM

Supply

Drainage

Support

Specialties

Appendix

## Open Flanges

## PVC/ABS Sch. 40 Connection



886-4P



888-AM

Item Number	Item Description	Pkg Type	Min Qty	Case Qty	Price
<b>ONE-PIECE PLASTIC RING</b>					
886-4A	4" Hub, ABS, Flush To Floor	BI	25	25	\$7.50
886-4P	4" Hub, PVC, Flush To Floor	BI	25	25	\$7.50
886-4PPK	4" Hub, PVC, Flush To Floor	CI	6	6	\$8.00
886-A	3" Hub/Inside 4", ABS, Flush To Floor	BI	20	20	\$3.59
886-APK	3" Hub/Inside 4", ABS, Flush To Floor	CI	10	10	\$4.09
886-P	3" Hub/Inside 4", PVC, Flush To Floor	BI	20	20	\$3.59
886-PPK	3" Hub/Inside 4", PVC, Flush To Floor	CI	10	10	\$4.09
888-A	Inside 3", ABS	BI	20	20	\$5.79
888-APK	Inside 3", ABS	CI	10	10	\$6.29
888-P	Inside 3", PVC	BI	20	20	\$5.79
888-PPK	Inside 3", PVC	CI	10	10	\$6.29
<b>STAINLESS STEEL SWIVEL RING</b>					
886-4AM	4" Hub, ABS, Flush To Floor	BI	25	25	\$12.59
886-4AMSPK	4" Spigot, ABS, Flush To Floor	CI	6	6	\$13.09
886-4PM	4" Hub, PVC, Flush To Floor	BI	25	25	\$12.59
886-4PMSPK	4" Spigot, PVC, Flush To Floor	CI	6	6	\$13.09
887-AM	3" Hub/Inside 4", ABS, Flush To Floor	BI	25	25	\$9.36
887-PM	3" Hub/Inside 4", PVC, Flush To Floor	BI	25	25	\$9.36
888-AM	Inside 3", ABS, Flush To Floor	BI	12	12	\$13.33
888-PM	Inside 3", PVC, Flush To Floor	BI	12	12	\$13.33

Supply

Drainage

Support

Specialties

Appendix

**PushTite™**

**Inside-Pipe Gasket Connection**

**Related Products**

PlumbPerfect™ Closet Bolts p 631

Item Number	Item Description	Pkg Type	Min Qty	Case Qty	Price
<b>INSIDE 3" DWV PIPE</b>					
888-GAM	Black ABS	BI	6	6	\$32.86
888-GPM	White ABS	CI	6	6	\$32.86
<b>INSIDE 4" DWV PIPE</b>					
886-GA	Black ABS	BI	5	5	\$31.01
886-GI	Cast Iron	CI	5	5	\$59.31
886-GP	White ABS	CI	5	5	\$31.01
887-GPTMK	PushTite Kit: 886-GP, Wax Ring, Closet Bolts, & Shims	CI	1	1	\$41.76



888-GPM



886-GI

Supply

Drainage

Support

Specialties

Appendix

Supply

Drainage

Support

Specialties

Appendix



889-AOM



889-POTM



889-GPOM



889-45AM

**FullFlush™**

**PVC/ABS Sch. 40 Hub Connection**

Item Number	Item Description	Pkg Type	Min Qty	Case Qty	Price
<b>OPEN OFFSET</b>					
889-AOM	3" Hub/Inside 4", ABS	BI	20	20	\$15.13
889-AOMPK	3" Hub/Inside 4", ABS	CI	6	6	\$15.63
889-POM	3" Hub/Inside 4", PVC	BI	20	20	\$15.13
889-POMPK	3" Hub/Inside 4", PVC	CI	6	6	\$15.63
<b>TKO™ OFFSET</b>					
889-AOTM	3" Hub/Inside 4", ABS	BI	20	20	\$16.20
889-POTM	3" Hub/Inside 4", PVC	BI	20	20	\$16.20

**FullFlush™**

**Inside-Pipe Gasket Connection**

Item Number	Item Description	Pkg Type	Min Qty	Case Qty	Price
889-GAOM	Inside 4", ABS	BI	5	5	\$36.01
889-GPOM	Inside 4", PVC	BI	5	5	\$36.01

**DropKick™**

**PVC/ABS Sch. 40 Spigot Connection**

Item Number	Item Description	Pkg Type	Min Qty	Case Qty	Price
889-45AM	3", ABS	BI	20	20	\$21.60
889-45AMPK2	3", ABS	CI	6	6	\$22.10
889-45PM	3", PVC	BI	20	20	\$21.60
889-45PMPK2	3", PVC	CI	6	6	\$22.10

**Cast Iron Closet Flanges**

**4" Compression Gasket Connection**

Item Number	Item Description	Pkg Type	Min Qty	Case Qty	Price
890-142	Over 4" Comp., Cast Iron	BI	4	4	\$30.32



890-142

**Brass Closet Flange Rings**

**for Lead Pipe Connection**

Item Number	Item Description	Pkg Type	Min Qty	Case Qty	Price
890-4BDPK	Over 4" Lead, Cast Brass	CI	10	10	\$41.32
890-4BPK	Over 4" Lead, Cast Brass	CI	10	10	\$30.74



890-4BDPK

**Urinal Flange Kit**

**2" PVC/ABS Sch. 40 Connection**

Item Number	Item Description	Pkg Type	Min Qty	Case Qty	Price
868-5A	2" Hub, ABS	BI	10	10	\$17.86
868-5P	2" Hub, PVC	BI	10	10	\$17.86
868-7A	Inside 2", ABS	BI	10	10	\$17.27
868-7P	Inside 2", PVC	BI	10	10	\$17.27
868-9A	2" Spigot, ABS	BI	10	10	\$16.96
868-9P	2" Spigot, PVC	BI	10	10	\$16.96



868-5A

Supply

Drainage

Support

Specialties

Appendix

Supply

Drainage

Support

Specialties

Appendix



886-MR

**Ringer™**

**Stainless Steel Repair Ring**

**Related Products**

Closet Repair Items - Bolts, Caps, Shims, Wax, Etc. p 631

Item Number	Item Description	Pkg Type	Min Qty	Case Qty	Price
886-MR	Stnls Steel Closet Ring	CI	20	20	\$8.24



886-MRM

**Two-Piece Repair Ring**

**Galvanized Steel Repair Ring**

Item Number	Item Description	Pkg Type	Min Qty	Case Qty	Price
886-MRM	Two-Piece Flange Repair Ring Kit, 1/Card	CI	8	8	\$24.67



886-411

**Raise-A-Ring™**

**Closet Flange Extension Ring**

Item Number	Item Description	Pkg Type	Min Qty	Case Qty	Price
886-411	Raise-A-Ring Kit: One 886-R Ring w/ Closet Bolts And Two Shims, Bagged	CI	20	20	\$7.16
886-R	7/16" Thick Flange Extension Ring, Carded	CI	20	20	\$4.49
886-RQ	1/4" Thick Flange Extension Ring	CI	20	20	\$3.12
886-RQK	Raise-A-Ring Kit: Three 886-Rq Rings w/ Closet Bolts, Bagged	BI	25	25	\$10.53



886-ER

**QuickSpacer™**

**Closet Flange Spacer Ring**

Item Number	Item Description	Pkg Type	Min Qty	Case Qty	Price
886-ER	3/4" Closet Flange Spacer Ring	BI	25	25	\$2.89



490-11320

**Save-A-Flange™**

**Broken Flange Repair Kit**

Item Number	Item Description	Pkg Type	Min Qty	Case Qty	Price
490-11320	Closet Flange Repair Kit	BI	1	10	\$7.76



### Closet Flange Floor Support Galvanized Steel Support Plates

Item Number	Item Description	Pkg Type	Min Qty	Case Qty	Price
490-11322	Floor Flange Support For Closet Flange, 1/Bag	Cl	1	10	\$24.31

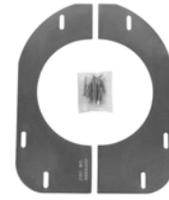

490-11322

Supply

Drainage

Support

Specialties

Appendix



# Backwater Valves

**ProCheck™ Shallow/Deep Access**

**Shallow Access**

**Accessories**



The ProCheck™ backwater valve is adaptable for shallow or deep-bury applications. The unique flapper also creates a much tighter seal than other backwater valves.



**ProCheck™**

**PVC/ABS Sch. 40 Hub Connection**

· For horizontal installations only

Item Number	Item Description	Pkg Type	Min Qty	Case Qty	Price
<b>PVC/ABS SCH. 40 HUB CONNECTION</b>					
869-S3A	3" ABS Hub	BI	4	4	\$49.84
869-S3APK	3" ABS Hub	CI	2	2	\$52.34
869-S3AS	3" ABS Hub w/ Shallow Access Sleeve Kit	BI	1	1	\$86.01
869-S3P	3" PVC Hub	BI	4	4	\$49.84
869-S3PPK	3" PVC Hub	CI	2	2	\$52.34
869-S3PS	3" PVC Hub w/ Shallow Access Sleeve Kit	BI	1	1	\$86.01
869-S4A	4" ABS Hub	BI	4	4	\$63.42
869-S4APK	4" ABS Hub	CI	2	2	\$65.92
869-S4AS	4" ABS Hub w/ Shallow Access Sleeve Kit	BI	1	1	\$98.55
869-S4P	4" PVC Hub	BI	4	4	\$63.42
869-S4PPK	4" PVC Hub	CI	2	2	\$65.92
869-S4PS	4" PVC Hub w/ Shallow Access Sleeve Kit	BI	1	1	\$98.55
<b>ACCESSORIES</b>					
869-S4ADB	ABS Deep-Bury Adapter Kit	BI	1	1	\$75.51
869-S4PDB	PVC Deep-Bury Adapter Kit	BI	1	1	\$75.51
869-SF3	Flapper & Carrier For 3" Backwater Valve	BI	10	10	\$13.20
869-SF4	Flapper & Carrier For 4" Backwater Valve	BI	10	10	\$15.04
869-SSK	Shallow Access Sleeve Kit - Collar/Sleeve/Lid	BI	1	1	\$66.63
869-SSL	Turn-Lock Collar & Lid For 16" Shallow Access Sleeve	BI	4	4	\$16.89
869-SVLB	Threaded Lid For Backwater Valve, Black w/ O-Ring	BI	10	10	\$9.08
869-SVLW	Threaded Lid For Backwater Valve, White w/ O-Ring	BI	10	10	\$9.08



869-S3P



869-S4AS



869-S4ADB

Supply

Drainage

Support

Specialties

Appendix

Supply

Drainage

Support

Specialties

Appendix



869-2P



869-23



803-2PK2

## DWV Backwater Valve

### PVC/ABS Sch. 40 Hub Connection

· For horizontal installations only

Item Number	Item Description	Pkg Type	Min Qty	Case Qty	Price
<b>PVC/ABS SCH. 40 HUB CONNECTION</b>					
869-2A	2" ABS Hub	BI	1	8	\$35.12
869-2P	2" PVC Hub	BI	1	8	\$35.12
869-2PS	2" PVC Hub w/ Extension Sleeve Kit	BI	1	1	\$44.59
869-6P	6" PVC Hub	B	1	1	\$268.65
<b>ACCESSORIES</b>					
869-23	Extension Sleeve Kit For 2" Valve; Includes Sleeve, Locking Collar And Lid	BI	1	1	\$22.03
869-60	O-Ring For 6" Threaded Lid	BI	1	10	\$18.26
869-61	Flapper & O-Ring For 6" Valve	BI	1	10	\$44.10
869-6P1	6" White PVC Threaded Lid	BI	1	2	\$106.59

## Backup Float Valve

### Inside-Pipe Compression Connection

· For vertical installations only

Item Number	Item Description	Pkg Type	Min Qty	Case Qty	Price
803-2PK2	2" Backup Float Valve, Bagged	CI	12	12	\$51.91
803-3PK2	3" Backup Float Valve, Bagged	CI	12	12	\$34.02
803-4PK2	4" Backup Float Valve, Bagged	CI	12	12	\$39.99

# Air Admittance Valves

**TurboVent™**

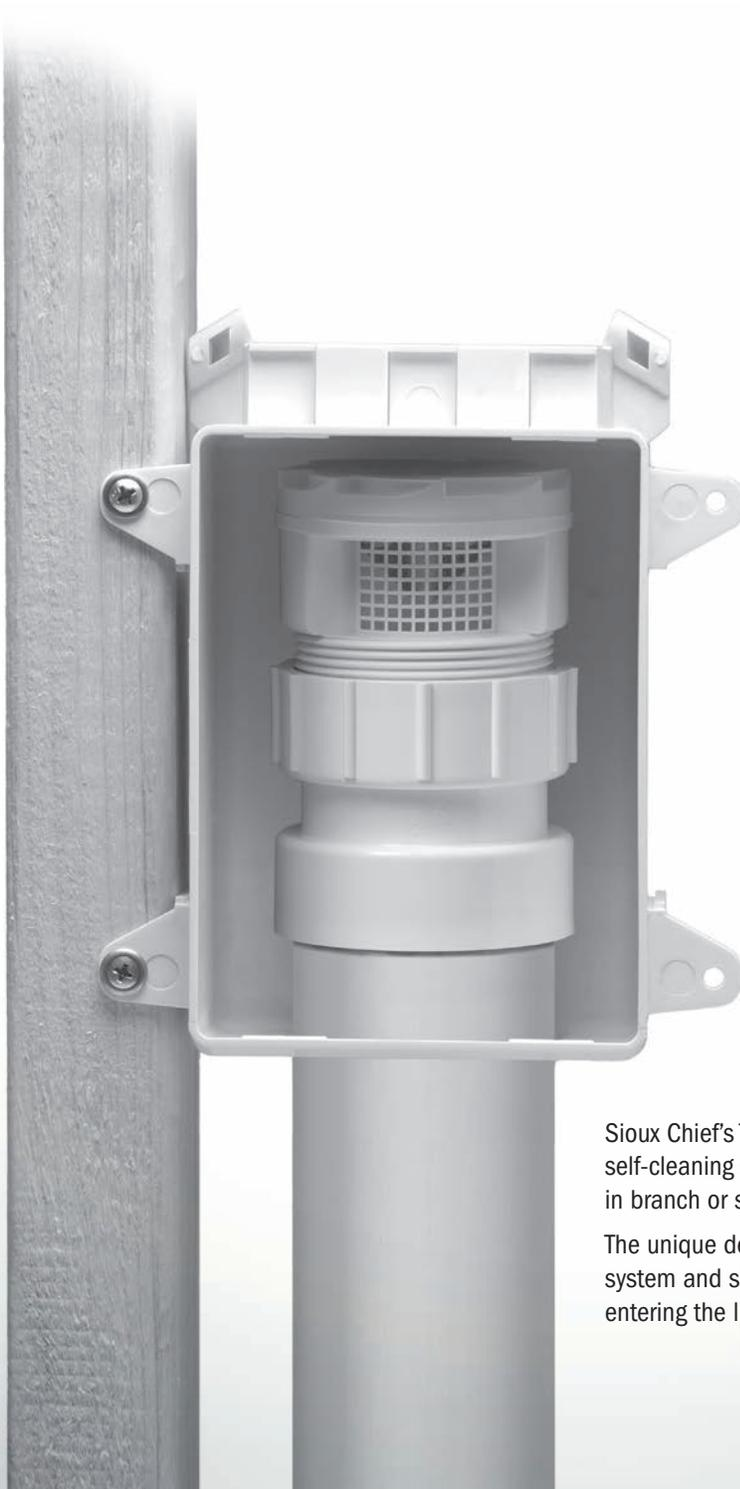

Sioux Chief's TurboVent™ is designed for reliability with a self-cleaning seal and engineered for performance in branch or stack applications.

The unique design responds quickly to allow air into the DWV system and seals positively to prevent sewer gas from entering the living space.





**MIP Thread Connection**

**Contractor Packs**

- Seal threads with PTFE tape - Do Not use pipe dope.
- Install upright/vertically, in accessible locations only.

Item Number	Item Description	Pkg Type	Min Qty	Case Qty	Price
250-11	TurboVent™ AAV Only - 1-1/2" MIP Adapter, 6/Bag	BI	1	4	\$113.42
250-12	TurboVent™ AAV Only - 2" MIP Adapter, 6/Bag	BI	1	4	\$113.42



250-11

**PVC Sch. 40 Hub Connection**

- Seal threads with PTFE tape - Do Not use pipe dope.
- Install upright/vertically, in accessible locations only.

Item Number	Item Description	Pkg Type	Min Qty	Case Qty	Price
<b>INDIVIDUALLY BOXED</b>					
250-11P	TurboVent™ AAV w/ 1-1/2" Adapter	BI	6	6	\$25.73
250-122P	TurboVent™ AAV w/ 1-1/2" - 2" Dual Fit Adapter	BI	6	6	\$26.93
250-12P	TurboVent™ AAV w/ 2" Adapter	BI	1	6	\$26.93
<b>BULK PACK</b>					
250-122PB	TurboVent™ AAV w/ 1-1/2" - 2" Dual Fit Adapter	BI	50	50	\$20.04
<b>CONTRACTOR PACKS</b>					
250-11PC	TurboVent™ AAV w/ 1-1/2" Adapter, 6/Bag	BI	1	8	\$123.83
250-122PC	TurboVent™ AAV w/ 1-1/2" - 2" Dual Fit Adapter, 6/Bag	BI	8	8	\$123.83
250-12PC	TurboVent™ AAV w/ 2" Adapter, 6/Bag	BI	1	8	\$123.83
<b>TUBULAR CONNECTION KIT</b>					
250-11TW	TurboVent™ AAV w/ 1-1/2" MIP Adapter & Tubular Waste Arm Extension	CI	1	6	\$31.71
<b>WITH OXBOX™ ACCESS BOX</b>					
250-696122P	TurboVent™ AAV w/ 1-1/2" - 2" Dual Fit Adapter & OxBox™ Kit	BI	6	6	\$34.11
250-696R122P	TurboVent™ AAV w/ 1-1/2" - 2" Dual Fit Adapter & Fire Rated OxBox™ Kit	BI	1	6	\$86.74
696-11P	TurboVent™ AAV w/ 1-1/2" Hub Adapter & OxBox™ Kit	BI	6	6	\$35.65
696-12P	TurboVent™ AAV w/ 2" Hub Adapter & OxBox™ Kit	BI	6	6	\$36.65



250-11P



250-122PB



250-11PC



250-11TW



250-696122P

Supply

Drainage

Support

Specialties

Appendix

Supply

Drainage

Support

Specialties

Appendix



250-122AB



250-12AC



250-696122A



842-712P

## ABS Sch. 40 Hub Connection

· Do not use pipe dope

Item Number	Item Description	Pkg Type	Min Qty	Case Qty	Price
<b>INDIVIDUALLY BOXED</b>					
250-11A	TurboVent™ AAV w/ 1-1/2" Adapter	BI	1	6	\$25.73
250-12A	TurboVent™ AAV w/ 2" Adapter	BI	1	6	\$26.93
<b>BULK PACK</b>					
250-122AB	TurboVent™ AAV w/ 1-1/2" - 2" Dual Fit Adapter	BI	50	50	\$20.04
<b>CONTRACTOR PACKS</b>					
250-11AC	TurboVent™ AAV w/ 1-1/2" Adapter, 6/Bag	BI	1	8	\$123.83
250-122AC	TurboVent™ AAV w/ 1-1/2" - 2" Dual Fit Adapter, 6/Bag	BI	1	8	\$123.83
250-12AC	TurboVent™ AAV w/ 2" Adapter, 6/Bag	BI	1	8	\$123.83
<b>TUBULAR CONNECTION KIT</b>					
250-11TB	TurboVent™ AAV w/ 1-1/2" MIP Adapter	CI	1	6	\$31.71
<b>WITH OXBOX™ ACCESS BOX</b>					
250-696122A	TurboVent™ AAV w/ 1-1/2" - 2" Dual Fit Adapter	BI	6	6	\$34.11
<b>250-696R122A</b>	TurboVent™ AAV w/ 1-1/2" - 2" Dual Fit Adapter	BI	1	6	\$86.74
696-11A	TurboVent™ AAV w/ 1-1/2" Hub Adapter & OxBox™ Kit	BI	1	6	\$35.65
696-12A	TurboVent™ AAV w/ 2" Hub Adapter & OxBox™ Kit	BI	1	6	\$36.65

## Accessories

Item Number	Item Description	Pkg Type	Min Qty	Case Qty	Price
696-1F	Single Frame For OxBox™	B	10	10	\$2.30
696-7	OxBox - Single Box w/ Hole For 2" Sch. 40 Pipe	B	10	10	\$5.91
696-LC	Louvered Frame Insert	B	10	10	\$4.73
<b>842-712A</b>	1-1/2" - 2" ABS Hub × 2" FIP Dual Fit Adapter	BI	10	10	\$3.52
842-712P	1-1/2" - 2" PVC Hub × 2" FIP Dual Fit Adapter	BI	10	10	\$3.52

# Residential Accessories

The SmartSaddle™ allows a new DWV line to be retro-fit into an existing 3" or 4" stack. The low-profile design uses stainless steel bands, making it perfect for stacks close to walls or other obstructions





**SmartSaddle™**

Item Number	Item Description	Pkg Type	Min Qty	Case Qty	Price
891-0312P	3" Sch. 40 Trunk, 1-1/2" Hub × 2" Spgt.	Cl	5	5	\$18.73
891-033P	3" Sch. 40 Trunk, 3" Hub × 4" Inside Fit	Cl	5	5	\$19.78
891-0412P	4" Sch. 40 Trunk, 1-1/2" Hub × 2" Spgt.	Cl	5	5	\$20.14
891-043P	4" Sch. 40 Trunk, 3" Hub × 4" Inside Fit	Cl	5	5	\$21.91
891-044P	4" Sch. 40 Trunk, 4" Hub	Cl	5	5	\$22.25



891-0312P

**Condensate Trap**

Item Number	Item Description	Pkg Type	Min Qty	Case Qty	Price
867-30PK	P-Trap, 8" Long × 2-1/2" Drop	Cl	25	25	\$4.83
867-35PK	Running Trap, 10-3/4 Long × 2" Drop	Cl	25	25	\$4.83



867-30PK

**PVC Vent Cap**

Item Number	Item Description	Pkg Type	Min Qty	Case Qty	Price
869-V34	Fits Over 3" Or 4" DWV Pipe w/ Two Set Screws	Cl	4	4	\$19.97



869-V34

**Pipe Bore Adapter**

Item Number	Item Description	Pkg Type	Min Qty	Case Qty	Price
880	4" To 6" Rolling O-Ring Adapter	B	25	25	\$13.22



880

Supply

Drainage

Support

Specialties

Appendix



# Testing

Test Devices

Gauges & Accessories

# Testing

## Test Devices

Test devices designed to seal the DWV system temporarily, for pressure tests, or permanently to provide occasional access to the system for maintenance. Mechanical, inflatable, and glue-on devices available.

## Gauges & Accessories

A variety of pressure gauges are available for both testing or permanent installation. Test assemblies combine gauges with convenient fittings for easy connection.



# Test Devices

**TestTitan™**

**T-Cone™**

**RealTite™**

**TeePee™**

**GripTip™**

**HardHat™**

**Flexible Test Caps**

**Knockout Test Plugs**

**QuickPlug™**

**Shower Arm  
Test Plug**





**882-2P**  
Page 467



**882-ST302**  
Page 467



**882-95**  
Page 470



**881-54**  
Page 470



**882-TT2**  
Page 470



**882-ES34**  
Page 471



**880-81**  
Page 471



**881-10C**  
Page 471



**881-02H**  
Page 471



**880-01P**  
Page 472



**880-1**  
Page 472



**881-3**  
Page 472



**880-012**  
Page 472



**234-QP2**  
Page 473



**988-6GT**  
Page 471



**882-647**  
Page 473

**TestTitan™**

**Mechanical Test Plug**

· Not intended for permanent use

Item Number	Item Description	Pkg Type	Min Qty	Case Qty	Price
<b>PIPE &amp; CLEANOUT PLUGS</b>					
882-1	1-1/2", for DWV Pipe/FIP Threads	Cl	10	10	\$4.55
882-2	2", for DWV Pipe/FIP Threads	Cl	10	10	\$4.55
882-3	3", for DWV Pipe/FIP Threads	Cl	10	10	\$6.84
882-35	3-1/2", for FIP Threads	Cl	10	10	\$8.46
882-4	4", for DWV Pipe/FIP Threads	Cl	10	10	\$8.46
882-41	4", for FIP Threads	Cl	10	10	\$11.07
<b>PNEUMATIC TEST PLUGS WITH AIR VALVE</b>					
882-1P	1-1/2", for DWV Pipe/FIP Threads	B	10	10	\$17.55
882-2P	2", for DWV Pipe/FIP Threads	B	10	10	\$17.55
882-3P	3", for DWV Pipe/FIP Threads	B	10	10	\$19.84
882-4P	4", for DWV Pipe/FIP Threads	B	10	10	\$21.47
<b>ACCESSORIES</b>					
882-115	Brass Fill & Drain Valve - FHT × FHT	Bl	1	25	\$28.06



882-1



882-2P

**T-Cone™**

**Mechanical Test Plug**

· Not intended for permanent use

Item Number	Item Description	Pkg Type	Min Qty	Case Qty	Price
<b>PIPE PLUGS</b>					
882-CS202	2" Flush-Head Pipe Plug, 2.067" Gasket O.D.	B	10	100	\$5.46
882-CS302	3" Flush-Head Pipe Plug, 3.068" Gasket O.D.	B	10	100	\$6.51
882-CS402	4" Flush-Head Pipe Plug, 4.026" Gasket O.D.	B	10	100	\$10.32
882-ST152	1-1/2" Raised-Head Pipe Plug, 1.61" Gasket O.D.	B	10	100	\$5.85
882-ST202	2" Raised-Head Pipe Plug, 2.067" Gasket O.D.	B	10	100	\$5.85
882-ST302	3" Raised-Head Pipe Plug, 3.068" Gasket O.D.	B	10	100	\$6.98
882-ST402	4" Raised-Head Pipe Plug, 4.026" Gasket O.D.	B	10	100	\$11.08
882-ST602	6" Raised-Head Pipe Plug, 6.065" Gasket O.D.	B	10	10	\$17.35
882-ST802	8" Raised-Head Pipe Plug, 7.981" Gasket O.D.	B	10	10	\$35.90
<b>SOCKET-FIT PLUGS</b>					
882-ST300	3" Raised-Head Socket Plug, 3.50" Gasket O.D.	B	10	100	\$8.52
<b>CLEANOUT PLUGS</b>					
882-EB152	1-1/2" Raised-Head Cleanout Plug, 1.78" Gasket O.D.	B	10	100	\$5.46
882-EB220	2" Raised-Head Cleanout Plug, 2.255" Gasket O.D.	B	10	100	\$5.46
882-EB320	3" Raised-Head Cleanout Plug, 3.378" Gasket O.D.	B	10	100	\$8.74
882-EB350	3-1/2" Raised-Head Cleanout Plug, 3.85" Gasket O.D.	B	10	100	\$10.58
882-EB420	4" Raised-Head Cleanout Plug, 4.336" Gasket O.D.	B	10	100	\$11.89



882-CS302



882-ST302

Supply

Drainage

Support

Specialties

Appendix

**RealTite™**  
**Cleanout Plug**

Item Number	Item Description	Pkg Type	Min Qty	Case Qty	Price
<b>HEX KEY OPERATION</b>					
882-RTPCS15	Expansion Plug for 1-1/2" FIP Cleanout Threads	CI	10	10	\$16.75
882-RTPCS20	Expansion Plug for 2" Pipe or FIP Cleanout Threads	CI	10	10	\$17.25
882-RTPCS25	Expansion Plug for 3" Pipe or 2-1/2" FIP Cleanout Threads	CI	10	10	\$22.75
882-RTPCS30	Expansion Plug for 3" FIP Cleanout Threads	CI	10	10	\$23.25
882-RTPCS35	Expansion Plug for 4" Pipe or 3-1/2" FIP Cleanout Threads	CI	10	10	\$24.00
882-RTPCS40	Expansion Plug for 4" FIP Cleanout Threads	CI	10	10	\$26.50
<b>STAINLESS STEEL FACE - HEX KEY OPERATION</b>					
882-RTPSS15	Expansion Plug for 1-1/2" FIP Cleanout Threads - Stainless Steel Plug Face	CI	10	10	\$37.54
882-RTPSS20	Expansion Plug for 2" Pipe or FIP Cleanout Threads - Stainless Steel Plug Face	CI	10	10	\$39.25
882-RTPSS25	Expansion Plug for 3" Pipe or 2-1/2" FIP Cleanout Threads - Stainless Steel Plug Face	CI	10	10	\$43.44
882-RTPSS30	Expansion Plug for 3" FIP Cleanout Threads - Stainless Steel Plug Face	CI	10	10	\$55.75
882-RTPSS35	Expansion Plug for 4" Pipe or 3-1/2" FIP Cleanout Threads - Stainless Steel Plug Face	CI	10	10	\$59.50
882-RTPSS40	Expansion Plug for 4" FIP Cleanout Threads - Stainless Steel Plug Face	CI	10	10	\$63.00
<b>THUMBSCREW OPERATION</b>					
882-RTPTB15	Expansion Plug for 1-1/2" FIP Cleanout Threads	CI	10	10	\$18.00
882-RTPTB20	Expansion Plug for 2" Pipe or FIP Cleanout Threads	CI	10	10	\$18.25
882-RTPTB25	Expansion Plug for 3" Pipe or 2-1/2" FIP Cleanout Threads	CI	10	10	\$23.25
882-RTPTB30	Expansion Plug for 3" FIP Cleanout Threads	CI	10	10	\$23.50
882-RTPTB35	Expansion Plug for 4" Pipe or 3-1/2" FIP Cleanout Threads	CI	10	10	\$24.75
882-RTPTB40	Expansion Plug for 4" FIP Cleanout Threads	CI	10	10	\$25.75
<b>HEX DRIVER OPERATION</b>					
882-RTPHH15	Expansion Plug for 1-1/2" FIP Cleanout Threads	CI	10	10	\$20.75
882-RTPHH20	Expansion Plug for 2" Pipe or FIP Cleanout Threads	CI	10	10	\$21.75
882-RTPHH25	Expansion Plug for 3" Pipe or 2-1/2" FIP Cleanout Threads	CI	10	10	\$23.00
882-RTPHH30	Expansion Plug for 3" FIP Cleanout Threads	CI	10	10	\$25.75
882-RTPHH35	Expansion Plug for 4" Pipe or 3-1/2" FIP Cleanout Threads	CI	10	10	\$29.75
882-RTPHH40	Expansion Plug for 4" FIP Cleanout Threads	CI	10	10	\$31.00
<b>FLUSH STAINLESS STEEL COVER - HEX KEY OPERATION</b>					
882-RTPFC15	Expansion Plug for 1-1/2" FIP Cleanout Threads with 4" Dia. Flush Stainless Steel Wall Cover	CI	10	10	\$26.75
882-RTPFC20	Expansion Plug for 2" Pipe or FIP Cleanout Threads with 4" Dia. Flush Stainless Steel Wall Cover	CI	10	10	\$27.00
882-RTPFC25	Expansion Plug for 3" Pipe or 2-1/2" FIP Cleanout Threads with 4" Dia. Flush Stainless Steel Wall Cover	CI	10	10	\$35.75
882-RTPFC30	Expansion Plug for 3" FIP Cleanout Threads with 5" Dia. Flush Stainless Steel Wall Cover	CI	10	10	\$36.50
882-RTPFC35	Expansion Plug for 4" Pipe or 3-1/2" FIP Cleanout Threads with 6" Dia. Flush Stainless Steel Wall Cover	CI	10	10	\$37.00
882-RTPFC40	Expansion Plug for 4" FIP Cleanout Threads with 6" Dia. Flush Stainless Steel Wall Cover	CI	10	10	\$44.75



882-RTPCS40



882-RTPSS35



882-RTPTB25



882-RTPHH30



882-RTPFC25

Supply

Drainage

Support

Specialties

Appendix

**RealTite™ (Cont)**

**Cleanout Plug**

Item Number	Item Description	Pkg Type	Min Qty	Case Qty	Price
<b>EXTENDED STAINLESS STEEL COVER - HEX KEY OPERATION</b>					
882-RTPCX15	Expansion Plug for 1-1/2" FIP Cleanout Threads with 4" Dia. Extended Stainless Steel Wall Cover	CI	10	10	\$39.72
882-RTPCX20	Expansion Plug for 2" Pipe or FIP Cleanout Threads with 4" Dia. Extended Stainless Steel Wall Cover	CI	10	10	\$40.00
882-RTPCX25	Expansion Plug for 3" Pipe or 2-1/2" FIP Cleanout Threads with 4" Dia. Extended Stainless Steel Wall Cover	CI	10	10	\$50.95
882-RTPCX30	Expansion Plug for 3" FIP Cleanout Threads with 5" Dia. Extended Stainless Steel Wall Cover	CI	10	10	\$51.81
882-RTPCX35	Expansion Plug for 4" Pipe or 3-1/2" FIP Cleanout Threads with 6" Dia. Extended Stainless Steel Wall Cover	CI	10	10	\$52.54
882-RTPCX40	Expansion Plug for 4" FIP Cleanout Threads with 6" Dia. Extended Stainless Steel Wall Cover	CI	10	10	\$62.57
<b>EXTENDED HEX STUD - HEX DRIVER OPERATION</b>					
882-RTPHX15	Expansion Plug for 1-1/2" FIP Cleanout Threads with 1/4-20 Tapped Extended Hex Stud	CI	10	10	\$39.00
882-RTPHX20	Expansion Plug for 2" Pipe or FIP Cleanout Threads with 1/4-20 Tapped Extended Hex Stud	CI	10	10	\$39.75
882-RTPHX25	Expansion Plug for 3" Pipe or 2-1/2" FIP Cleanout Threads with 1/4-20 Tapped Extended Hex Stud	CI	10	10	\$42.00
882-RTPHX30	Expansion Plug for 3" FIP Cleanout Threads with 1/4-20 Tapped Extended Hex Stud	CI	10	10	\$42.50
882-RTPHX35	Expansion Plug for 4" Pipe or 3-1/2" FIP Cleanout Threads with 1/4-20 Tapped Extended Hex Stud	CI	10	10	\$44.25
882-RTPHX40	Expansion Plug for 4" FIP Cleanout Threads with 1/4-20 Tapped Extended Hex Stud	CI	10	10	\$46.25
<b>DRAIN LINE SECURITY PIN - HEX KEY OPERATION</b>					
882-RTPSP25	Expansion Plug for 3" Pipe or 2-1/2" FIP Cleanout Threads with Drain Line Security Pin	CI	10	10	\$49.10
882-RTPSP30	Expansion Plug for 3" FIP Cleanout Threads with Drain Line Security Pin	CI	10	10	\$50.27
882-RTPSP35	Expansion Plug for 4" Pipe or 3-1/2" FIP Cleanout Threads with Drain Line Security Pin	CI	10	10	\$54.95
882-RTPSP40	Expansion Plug for 4" FIP Cleanout Threads with Drain Line Security Pin	CI	10	10	\$56.12
<b>DRAIN LINE SECURITY HOOK - HEX KEY OPERATION</b>					
882-RTPSH25	Expansion Plug for 3" Pipe or 2-1/2" FIP Cleanout Threads with Drain Line Security Hook	CI	10	10	\$74.83
882-RTPSH30	Expansion Plug for 3" FIP Cleanout Threads with Drain Line Security Hook	CI	10	10	\$78.34
882-RTPSH35	Expansion Plug for 4" Pipe or 3-1/2" FIP Cleanout Threads with Drain Line Security Hook	CI	10	10	\$81.85
882-RTPSH40	Expansion Plug for 4" FIP Cleanout Threads with Drain Line Security Hook	CI	10	10	\$81.85
<b>ACCESSORIES</b>					
882-HEXKEY1	5/32" Hex key - T-handle	BI	1	50	\$16.74
882-RTEX35	3-1/2" Expansion gasket - fits over 3" plugs	CI	10	10	\$17.79
882-RTEX40	4" Expansion gasket - fits over 3-1/2" plugs	CI	10	10	\$17.79



882-RTPHX25



882-RTPSP30



882-RTPSH40



882-HEXKEY1

Supply

Drainage

Support

Specialties

Appendix



882-96

### HandTite™

#### Mechanical Test Plug

· Not intended for permanent use

Item Number	Item Description	Pkg Type	Min Qty	Case Qty	Price
882-95	5" Test Plug	B	1	30	\$47.21
882-96	6" Test Plug	B	1	30	\$51.51
882-98	8" Test Plug	B	1	12	\$111.60



881-54

### TeePee™

#### Mechanical Test Tool

Item Number	Item Description	Pkg Type	Min Qty	Case Qty	Price
<b>CLEANOUT TEE TEST TOOL</b>					
881-52	2" Mechanical Test Tool	B	1	5	\$71.57
881-53	3" Mechanical Test Tool	B	1	5	\$81.29
881-54	4" Mechanical Test Tool	B	1	1	\$94.31
881-56	6" Mechanical Test Tool	B	1	1	\$260.12
881-58	8" Mechanical Test Tool	B	1	1	\$608.03
881-510	10" Mechanical Test Tool	B	1	1	\$786.87
<b>REPLACEMENT SEAL</b>					
881-01-2	2" Plug Replacement Seal	BI	5	5	\$29.27
881-01-3	3" Plug Replacement Seal	BI	5	5	\$39.03
881-01-4	4" Plug Replacement Seal	BI	5	5	\$48.79
<b>881-01-6</b>	6" Plug Replacement Seal	BI	1	5	\$71.54
<b>881-01-8</b>	8" Plug Replacement Seal	BI	2	2	\$96.39
<b>881-01-10</b>	10" Plug Replacement Seal	B	1	1	\$175.34



882-TT2

### Inflatable Cleanout Tee Plug

· Max test pressure: 5 PSIG air, 30 FT-HD

Item Number	Item Description	Pkg Type	Min Qty	Case Qty	Price
882-TT2	2" Inflatable Plug	BI	1	48	\$66.58
882-TT3	3" Inflatable Plug	BI	1	18	\$74.01
882-TT4	4" Inflatable Plug	BI	1	8	\$85.51

## Inflatable Test Plug

• Max test pressure: 10 PSIG air, 30 FT-HD

Item Number	Item Description	Pkg Type	Min Qty	Case Qty	Price
<b>SINGLE-STAGE PLUG</b>					
882-ES12	1 1/2"-2" × 5 1/2" Long For 1.17" - 2.25" Pipe	Bl	1	1	\$62.63
882-ES23	2"-3" × 5" Long For 1.75" - 3.25" Pipe	Bl	1	1	\$66.11
882-ES34	3"-4" × 7 1/4" Long For 2.88" - 4.25" Pipe	Bl	1	1	\$66.11
882-ES46	4"-6" × 10 1/4" Long For 3.77" - 6.25" Pipe	Bl	1	1	\$149.61
<b>DUAL-STAGE PLUG</b>					
882-EL23	2"-3" × 22" Long For 1.75" - 3.25" Pipe	Bl	1	1	\$173.96
882-EL34	3"-4" × 25" Long For 2.88" - 4.25" Pipe	Bl	1	1	\$208.75
882-EL46	4"-6" × 29 1/2" Long For 3.77" - 6.25" Pipe	Bl	1	1	\$417.49



882-ES34

## GripTip™

• Not intended for permanent use

Item Number	Item Description	Pkg Type	Min Qty	Case Qty	Price
<b>OVER-PIPE TEST CAPS</b>					
880-81	1-1/2" Test Cap, White	B	25	200	\$0.48
880-81C	1-1/2" Test Cap, Magenta	B	25	200	\$0.51
880-81PK	1-1/2" Test Cap, White	Cl	50	50	\$0.73
880-82	2" Test Cap, White	B	25	100	\$0.54
880-82C	2" Test Cap, Magenta	B	25	100	\$0.57
880-82PK	2" Test Cap, White	Cl	50	50	\$0.79
880-83	3" Test Cap, White	B	10	50	\$0.88
880-83C	3" Test Cap, Magenta	B	10	50	\$0.90
880-83PK	3" Test Cap, White	Cl	25	25	\$1.13
880-84	4" Test Cap, White	B	10	50	\$1.07
880-84C	4" Test Cap, Magenta	B	10	50	\$1.09
880-84PK	4" Test Cap, White	Cl	25	25	\$1.32
<b>INSIDE-PIPE TEST PLUGS</b>					
881-10	1-1/2" Test Plug, White	B	25	200	\$0.45
881-10C	1-1/2" Test Plug, Magenta	B	25	200	\$0.49
881-12	2" Test Plug, White	B	25	100	\$0.52
881-12C	2" Test Plug, Magenta	B	25	100	\$0.54
881-13	3" Test Plug, White	B	10	50	\$0.69
881-13C	3" Test Plug, Magenta	B	10	50	\$0.73
881-14	4" Test Plug, White	B	10	50	\$0.93
881-14C	4" Test Plug, Magenta	B	10	50	\$0.95
<b>TUBULAR TEST NUT</b>					
230-9506GT	PVC 1-1/2 Hub Trap Adapter w/ GripTip Test Nut	B	25	25	\$1.73
988-6GT	1-1/2" Trap Adapter Nut w/ GripTip	B	25	25	\$0.88
<b>ACCESSORIES</b>					
881-02A	Air Test Fitting 15 PSI Gauge 5/8" O.D. Comp × Air Filler Valve	B	1	10	\$35.77
881-02FP	Replacement 5/8" Poly Ferrule	B	100	1000	\$0.77
881-02H	Water Test Valve 5/8" O.D. Comp × Female Swivel Hose Thread	B	1	25	\$22.11



880-81



881-10C



881-02A



881-02H

Supply

Drainage

Support

Specialties

Appendix



880-02A

### HardHat™

· Not intended for permanent use

Item Number	Item Description	Pkg Type	Min Qty	Case Qty	Price
<b>PVC TEST CAPS</b>					
880-01P	1-1/2" Sch. 40 Pipe	B	50	500	\$0.58
880-02P	2" Sch. 40 Pipe	B	25	500	\$0.58
880-03P	3" Sch. 40 Pipe	B	20	200	\$0.81
880-04P	4" Sch. 40 Pipe	B	25	100	\$0.90
<b>ABS TEST CAPS</b>					
880-01A	1-1/2" Sch. 40 Pipe	B	50	500	\$0.58
880-02A	2" Sch. 40 Pipe	B	25	500	\$0.58
880-03A	3" Sch. 40 Pipe	B	20	200	\$0.81
880-04A	4" Sch. 40 Pipe	B	25	100	\$0.90

### Flexible PVC Test Caps



880-1

Item Number	Item Description	Pkg Type	Min Qty	Case Qty	Price
880-1	1-1/2"	B	25	25	\$4.73
880-2	2"	B	25	25	\$4.92
880-3	3"	B	25	25	\$6.44
880-4	4"	B	25	25	\$7.80

### Knockout Test Plugs



881-3

Item Number	Item Description	Pkg Type	Min Qty	Case Qty	Price
881-1	1-1/2" Plug	B	100	1000	\$0.41
881-2	2" Plug	B	100	1000	\$0.52
881-3	3" Plug	B	50	500	\$0.78
881-4	4" Plug	B	50	500	\$0.89

### Dual-Fit Test Caps



880-012

Item Number	Item Description	Pkg Type	Min Qty	Case Qty	Price
880-012	1-1/2" And 2" Sch. 40 Cap	B	100	500	\$1.07
880-034	3" And 4" Sch. 40 Cap	B	50	250	\$1.83



**QuickPlug™**

Item Number	Item Description	Pkg Type	Min Qty	Case Qty	Price
234-QP	1-1/2" Trap Adapter Test Plug	B	25	100	\$1.09
234-QP2	1-1/4" Trap Adapter Test Plug	B	25	100	\$1.09



234-QP2

**GripTip™**

**Trap Adapter Test Nut**

Item Number	Item Description	Pkg Type	Min Qty	Case Qty	Price
988-6GT	1-1/2" Trap Adapter Nut w/ GripTip	B	25	25	\$0.88



988-6GT

**Shower Arm Test Plug**

Item Number	Item Description	Pkg Type	Min Qty	Case Qty	Price
882-647	1/2" MIP Reuseable Test Plug	BI	24	120	\$3.36
882-647W	882-647 Replacement Washer, 25/Bag	B	1	20	\$9.06



882-647

Supply

Drainage

Support

Specialties

Appendix



# Gauges & Accessories

**Test Gauge Assemblies**

**Test Gauges**

**Hand Pump**





**Test Gauge Assemblies**

Item Number	Item Description	Pkg Type	Min Qty	Case Qty	Price
<b>FIP X AIR VALVE</b>					
355-05PK2	Air Valve Fitting Only, 3/4" FIP, Clamshell	Cl	1	10	\$15.23
355-15PK1	0-15 Lb. Gas Test Fitting, 3/4" FIP, Clamshell	Cl	1	10	\$42.30
355-30PK1	0-30 Lb. Gas Test Fitting, 3/4" FIP, Clamshell	Cl	1	10	\$42.30
355-60PK1	0-60 Lb. Gas Test Fitting, 3/4" FIP, Clamshell	Cl	1	10	\$42.30
355-100PK1	0-100 Lb. Gas Test Fitting, 3/4" FIP, Clamshell	Cl	1	10	\$31.10
<b>COMPRESSION X AIR VALVE</b>					
881-02A	Air Test Fitting 15 PSI Gauge 5/8" O.D. Comp x Air Filler Valve	B	1	10	\$35.77
882-110	Air Test Fitting 100 PSI Gauge 5/8" O.D. Comp x Air Filler Valve	B	1	6	\$36.74
<b>HOSE THREAD CONNECTION</b>					
360-300PK1	300 PSI Water Test Gauge - FHT Swivel with Drag-Point Indicator	B	1	10	\$33.39
882-105	Air/Water Test Fitting 300 PSI Gauge, Female Swivel Hose Connections	B	1	6	\$88.12



355-15PK1



881-02A



882-105

**Test Gauges**

Item Number	Item Description	Pkg Type	Min Qty	Case Qty	Price
356-100PK1	0-100 PSI Pressure Gauge 1 Lb. Grad, Clamshell	Cl	1	10	\$19.02
356-300PK1	0-300 PSI Pressure Gauge 10 Lb. Grad, Clamshell	Cl	1	10	\$19.02
356-30PK1	0-30 PSI Pressure Gauge 1/2 Lb. Grad, Clamshell	Cl	1	10	\$19.02
356-60PK1	0-60 PSI Pressure Gauge 1 Lb. Grad, Clamshell	Cl	1	10	\$13.99
360-15PK1	0-15 PSI Pressure Gauge 1/2 Lb. Grad, Clamshell	Cl	1	10	\$19.02



356-100PK1

**Hand Pump**

Item Number	Item Description	Pkg Type	Min Qty	Case Qty	Price
882-EHPG	High-Pressure Hand Pump w/ Pressure Gauge	Bl	1	1	\$86.01



882-EHPG

Supply

Drainage

Support

Specialties

Appendix



# Support

Supply Hangers

DWV Hangers

Brackets





# **Supply Hangers**

**Plastic CTS**

**Metal CTS/IPS**

**Anchors & Fasteners**

# Supply Hangers

## Plastic CTS

Durable, engineered plastic clamps for CTS tubing. Unique and innovative designs, made from corrosion and impact resistant polymers to ensure long-lasting performance. All Plastic CTS hangers are 100% compatible with PEX, copper and CPVC.

## Metal CTS/IPS

Metal tubing hangers offer the strength, durability and heat-resistance of steel when required for specific applications. Copper and zinc plating protect against corrosion.

## Anchors & Fasteners

Anchors, screws, bands, and other hardware for use with supply hangers.

# Plastic CTS

**PickUp™ Talon, TubeTalon™, TwinTalon™**

**SiouxStrap™, PadLock™, Totem™, EZ Tube Clamp**

**EZ Suspension, EZ Glide Tube Insulator**

**Suspensulator™, PipeEye™, BiFolator,™**

**MainBlock™, TouchDown™**

**TD+™ Strut Clamp**

**HangsTuff Jr.™**

**Single Hole  
Tube Strap**





**556-3**  
Page 485



**555-2**  
Page 485



**555-23**  
Page 486



**551-3**  
Page 486



**551-P2Q**  
Page 487



**552-A2**  
Page 487



**559-2**  
Page 488



**557-2Q**  
Page 488



**558-2**  
Page 489



**558-E2**  
Page 489



**558-M23**  
Page 489



**558-23**  
Page 490



**550-11Q**  
Page 490



**550-2111**  
Page 491



**553-3W**  
Page 491



**500-2**  
Page 495



**550-02**  
Page 491



**523-32**  
Page 495



**506-34**  
Page 496



**512-36PK**  
Page 496



**590-10**  
Page 499



**590-4411**  
Page 499



**612-2S**  
Page 500



**554-608**  
Page



**574-72**  
Page 500

**PickUp Talon™**

**Isolating Drive Hook**

Item Number	Item Description	Pkg Type	Min Qty	Case Qty	Price
<b>BLACK</b>					
556-2	1/2" CTS w/ Nail	B	100	1000	\$0.09
556-2BKT	1/2" CTS w/ Nail, 1800/bucket	B	1	1	\$169.60
556-2PK2	1/2" CTS w/ Nail, 10/Bag	Cl	10	10	\$1.67
556-2PK3	1/2" CTS w/ Nail, (Contr Pack), 100/Bag	Cl	1	10	\$9.95
556-2S	1/2" CTS w/ Screw	B	300	300	\$0.41
556-3	3/4" CTS w/ Nail	B	100	1000	\$0.15
556-3BKT	3/4" CTS w/ Nail, 1000/bucket	B	1	1	\$151.00
556-3PK2	3/4" CTS w/ Nail, 10/Bag	Cl	10	10	\$2.22
556-3PK3	3/4" CTS w/ Nail, (Contr Pack), 100/Bag	Cl	1	10	\$14.70
556-3S	3/4" CTS w/ Screw	B	300	300	\$0.47
556-4	1" CTS w/ Nail	B	50	500	\$0.42
556-4BKT	1" CTS w/ Nail, 500/bucket	B	1	1	\$214.00
556-4PK2	1" CTS w/ Nail, 10/Bag	Cl	10	10	\$4.95
556-4PK3	1" CTS w/ Nail, (Contr Pack), 50/Bag	Cl	1	10	\$21.00
556-5	1-1/4" CTS w/ Nail	B	250	250	\$0.75
556-5S	1-1/4" CTS w/ Screw	B	25	100	\$1.15
<b>IVORY</b>					
556-4C	1" CTS w/ Nail	B	50	500	\$0.41



556-2



556-2BKT



556-2C

**TubeTalon™**

**Drive Hook**

Item Number	Item Description	Pkg Type	Min Qty	Case Qty	Price
555-1	3/8" CTS w/ Nail	B	100	1000	\$0.16
555-2	1/2" CTS w/ Nail	B	100	1000	\$0.09
555-2BKT	1/2" CTS w/ Nail, 2200/bucket	B	1	1	\$206.40
555-3	3/4" CTS w/ Nail	B	100	1000	\$0.17
555-3BKT	3/4" CTS w/ Nail, 1,100/bucket	B	1	1	\$191.00
555-4	1" CTS w/ Nail	B	50	500	\$0.43
555-4BKT	1" CTS w/ Nail, 600/bucket	B	1	1	\$262.00



555-2



555-2BKT

Supply

Drainage

Support

Specialties

Appendix

Supply

Drainage

Support

Specialties

Appendix



555-23



555-23BKT



551-2



551-3BKT



551-2C

**TwinTalon™**

**Double-Duty Drive Hook**

Item Number	Item Description	Pkg Type	Min Qty	Case Qty	Price
555-23	1/2" - 3/4" CTS w/ Nail	B	100	1000	\$0.14
555-23BKT	1/2"-3/4" CTS w/ Nail, 950/bucket	B	1	1	\$140.80
555-23PK2	1/2" - 3/4" CTS w/ Nail, 10/Bag	CI	10	10	\$2.19
555-23PK3	1/2" - 3/4" CTS w/ Nail, (Contr Pack), 100/Bag	BI	1	10	\$14.40
555-23S	1/2" - 3/4" CTS w/ Screw	B	300	300	\$0.43
555-623	1/2" - 3/4" CTS w/ Short 1-5/8" Nail	B	100	1000	\$0.25
555-623PK2	1/2" - 3/4" CTS w/ Short 1-5/8" Nail, 10/Bag	CI	10	10	\$3.21

**SiouxStrap™**

**Full Clamp Tube Hanger**

Item Number	Item Description	Pkg Type	Min Qty	Case Qty	Price
<b>BLACK</b>					
551-2	1/2" CTS w/ Nail	B	100	1000	\$0.18
551-2BKT	1/2" CTS w/ Nail, 1200/bucket	B	1	1	\$218.80
551-2PK2	1/2" CTS w/ Nail, 10/Bag	CI	20	20	\$2.54
551-3	3/4" CTS w/ Nail	B	50	500	\$0.26
551-3BKT	3/4" CTS w/ Nail, 700/bucket	B	1	1	\$186.00
551-3PK2	3/4" CTS w/ Nail, 10/Bag	CI	20	20	\$3.35
551-4	1" CTS w/ Nail	B	25	250	\$0.62
551-4BKT	1" CTS w/ Nail, 400/bucket	B	1	1	\$252.00
551-4PK2	1" CTS w/ Nail, 10/Bag	CI	20	20	\$6.95
<b>IVORY</b>					
551-2C	1/2" CTS w/ Nail	B	100	1000	\$0.19
551-3C	3/4" CTS w/ Nail	B	50	500	\$0.26
551-4C	1" CTS w/ Nail	B	25	250	\$0.62

**PadLock™**

**Full Clamp Tube Strap**

Item Number	Item Description	Pkg Type	Min Qty	Case Qty	Price
<b>STANDARD</b>					
551-P2	1/2" CTS w/ Nail	B	100	1000	\$0.25
551-P2PK3	1/2" CTS w/ Nail, (Contr Pack), 100/Bag	Cl	1	10	\$24.60
551-P2S	1/2" CTS w/ Screw	B	300	300	\$0.42
551-P3	3/4" CTS w/ Nail	B	50	500	\$0.37
551-P3PK3	3/4" CTS w/ Nail, (Contr Pack), 50/Bag	Cl	1	10	\$18.50
551-P3S	3/4" CTS w/ Screw	B	300	300	\$0.58
<b>ACOUSTICAL</b>					
551-P2Q	1/2" CTS PipeDown™ Padlock™ w/ Drill Tip Screw	B	100	100	\$2.82
551-P3Q	3/4" CTS PipeDown™ Padlock™ w/ Drill Tip Screw	B	100	100	\$3.32
551-P4Q	1" CTS PipeDown™ Padlock™ w/ Drill Tip Screw	B	25	25	\$4.14
551-P5Q	1-1/4" CTS PipeDown™ Padlock™ w/ Drill Tip Screw, Contr Pack	B	25	25	\$5.22



551-P2



551-P3Q

**Totem™**

**Offset CTS Hanger**

Item Number	Item Description	Pkg Type	Min Qty	Case Qty	Price
<b>SINGLE</b>					
552-A2	1/2" CTS w/ Nail	B	50	50	\$0.30
552-A3	3/4" CTS w/ Nail	B	50	50	\$0.38
<b>TWIN</b>					
552-B22	1/2" × 1/2" CTS w/ Nail	B	50	50	\$0.41
552-B23	1/2" × 3/4" CTS w/ Nail	B	50	50	\$0.44
552-B33	3/4" × 3/4" CTS w/ Nail	B	50	50	\$0.47
<b>STACKED</b>					
552-C22	1/2" × 1/2" CTS w/ Nail	B	50	50	\$0.41
552-C23	1/2" × 3/4" CTS w/ Nail	B	50	50	\$0.44
552-C33	3/4" × 3/4" CTS w/ Nail	B	50	50	\$0.47



552-A2



552-B23



552-C22

Supply

Drainage

Support

Specialties

Appendix

**EZ Glide™ Tube Clamp**

**Tube Clamp**

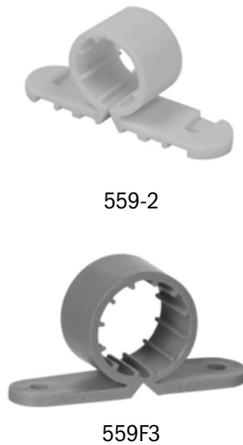

559-2

559F3

Item Number	Item Description	Pkg Type	Min Qty	Case Qty	Price
<b>STANDARD</b>					
559-2	1/2" CTS	B	100	1000	\$0.31
559-2PK2	1/2" CTS, 5/Bag	CI	10	10	\$2.30
559-3	3/4" CTS	B	50	1000	\$0.32
559-3PK2	3/4" CTS, 5/Bag	CI	10	10	\$2.35
559-4	1" CTS	B	50	500	\$0.71
559-4PK2	1" CTS, 5/Bag	CI	10	10	\$4.30
559-5	1-1/4" CTS	B	25	250	\$0.91
559-6	1-1/2" CTS	B	25	250	\$1.44
559-7	2" CTS	B	25	250	\$1.58
559-7PK2	2" CTS, 5/Bag	CI	10	10	\$8.65
<b>PLENUM-RATED</b>					
559F2	E84 1/2" CTS	B	100	1000	\$1.72
559F3	E84 3/4" CTS	B	50	500	\$2.04
559F4	E84 1" CTS	B	50	500	\$3.90
559F5	E84 1-1/4" CTS	B	10	10	\$4.80
<b>559F6</b>	E84 1-1/2" CTS	B	10	10	\$4.80
559F7	E84 2" CTS	B	10	10	\$5.74

**EZ Glide™ Suspension Clamp**

**Suspension Clamp**



557-2

Item Number	Item Description	Pkg Type	Min Qty	Case Qty	Price
<b>STANDARD</b>					
557-2	1/2" CTS	B	100	1000	\$0.31
557-2PK2	1/2" CTS, 5/Bag	CI	10	10	\$2.30
557-3	3/4" CTS	B	100	1000	\$0.32
557-3PK2	3/4" CTS, 5/Bag	CI	10	10	\$2.35
557-4	1" CTS	B	50	500	\$0.71
557-4PK2	1" CTS, 5/Bag	CI	10	10	\$4.30
557-5	1-1/4" CTS	B	25	250	\$1.30
557-5PK2	1-1/4" CTS, 5/Bag	CI	10	10	\$7.25
557-6	1-1/2" CTS	B	25	250	\$1.45
557-6PK2	1-1/2" CTS, 5/Bag	CI	10	10	\$8.00
557-7	2" CTS	B	25	250	\$1.88
<b>ACOUSTICAL</b>					
557-2Q	PipeDown™ 1/2" CTS Thru-Stud/Suspension Clamp, Contr Pack	B	50	50	\$2.99
557-3Q	PipeDown™ 3/4" CTS Thru-Stud/Suspension Clamp, Contr Pack	B	50	50	\$3.57
557-4Q	PipeDown™ 1" CTS Thru-Stud/Suspension Clamp, Contr Pack	B	25	25	\$7.23
557-5Q	PipeDown™ 1-1/4" CTS Thru-Stud/Suspension Clamp, Contr Pack	B	25	25	\$8.74

Supply

Drainage

Support

Specialties

Appendix



**EZ Glide™ Suspension Clamp (Cont)**

**Suspension Clamp**

Item Number	Item Description	Pkg Type	Min Qty	Case Qty	Price
<b>PLENUM-RATED</b>					
557F2	E84 1/2" CTS	B	100	1000	\$1.72
557F3	E84 3/4" CTS	B	50	500	\$2.04
557F4	E84 1" CTS	B	50	500	\$2.80
557F5	E84 1-1/4" CTS	B	10	10	\$3.90
557F6	E84 1-1/2" CTS	B	10	10	\$4.80
557F7	E84 2" CTS	B	10	10	\$5.74



C557F2

**EZ Glide™ Tube Insulator**

Item Number	Item Description	Pkg Type	Min Qty	Case Qty	Price
558-2	1/2" CTS	B	50	500	\$0.48
558-2PK2	1/2" CTS, 5/Bag	Cl	10	10	\$3.15
558-3	3/4" CTS	B	50	500	\$0.49
558-3PK2	3/4" CTS, 5/Bag	Cl	10	10	\$3.20
558-4	1" CTS	B	25	250	\$0.51



558-2

**Suspensulator™**

**Tube Suspension Clamp & Insulator**

Item Number	Item Description	Pkg Type	Min Qty	Case Qty	Price
558-E1	3/8" CTS	B	50	500	\$0.46
558-E2	1/2" CTS	B	50	500	\$0.36
558-E2PK2	1/2" CTS, 5/Bag	Cl	10	10	\$2.55
558-E3	3/4" CTS	B	50	500	\$0.37
558-E3PK2	3/4" CTS, 5/Bag	Cl	10	10	\$2.60
558-E4	1" CTS	B	25	250	\$0.49
558-E4PK2	1" CTS, 5/Bag	Cl	10	10	\$3.20



558-E3

**PipeEye™**

**Metal Stud Insulator**

Item Number	Item Description	Pkg Type	Min Qty	Case Qty	Price
<b>STANDARD</b>					
558-M23	1/2" - 3/4" CTS Black	B	100	1000	\$0.32
558-M23H	1/2" - 3/4" CTS Red, Contr Pack	B	100	1000	\$0.32
558-M23PK2	1/2" - 3/4" CTS Black, Contr Pack, 5/Bag	Cl	10	10	\$2.35
558-M4	1" CTS, Black	B	25	250	\$0.38
558-M4H	1" CTS, Red	B	50	1000	\$0.38
<b>FLAME RETARDANT &amp; GLUEABLE</b>					
558-M23R	1/2" - 3/4" CTS White	B	100	1000	\$0.38
558-M4R	1" CTS White	B	25	250	\$0.43



558-M23



558-M23R

Supply

Drainage

Support

Specialties

Appendix

Supply



558-23

**BIFolator™**

**Reversible Tube Insulator**

Item Number	Item Description	Pkg Type	Min Qty	Case Qty	Price
558-23	1/2" & 3/4" CTS, Flexible LDPE (Ivory)	B	100	1000	\$0.32
558-23B	1/2" & 3/4" CTS, Rigid HDPE (Black)	B	100	1000	\$0.32

Drainage



525-33

**MainBlock™**

**1-1/2" Offset CTS Pipe Clamp**

Item Number	Item Description	Pkg Type	Min Qty	Case Qty	Price
525-32C	1/2" CTS w/ Screws, Contr Pack, 1/Bag	BI	1	25	\$6.38
525-33	3/4" CTS w/ Screws, 1/Bag	B	25	25	\$6.58
525-33C	3/4" CTS w/ Screws, Contr Pack, 1/Bag	BI	1	25	\$6.58
525-34	1" CTS w/ Screws, 1/Bag	B	25	25	\$6.75
525-34C	1" CTS w/ Screws, Contr Pack, 1/Bag	BI	1	25	\$6.75
525-35	1-1/4" CTS w/ Screws, 1/Bag	B	25	25	\$7.18
525-35C	1-1/4" CTS w/ Screws, 1/Bag	X	1	25	\$7.18

Support

Specialties

Appendix



550-11

**TouchDown™**

**Universal Pipe Clamp**

· For 1/4" - 1" CTS and 1/8" - 1" Sch. 40 pipe

Item Number	Item Description	Pkg Type	Min Qty	Case Qty	Price
<b>STANDARD</b>					
550-11	1 Bridge, 1 Base, 1 Screw/Bag	B	100	100	\$0.82
550-11PK2	5 Bridges, 5 Bases, 5 Screws/Bag	CI	1	10	\$4.85
550-12	Contractor Pack: 100 Bridges, 100 Bases, 100 Screws (Bulk)	B	1	1	\$61.34
<b>BEAM CLAMP</b>					
550-11E	1 Bridge, 1 Base w/ Attached Beam Clamp/Bag	BI	100	100	\$4.28
<b>ACOUSTICAL CLAMP</b>					
550-11Q	PipeDown™ 1 Bridge, 1 Base, 1 Screw, 2 Inserts/Bag	B	100	100	\$1.92
550-11QPK2	PipeDown™ 10 Bridges, 10 Bases, 10 Screws, 20 Inserts/Bag	CI	1	10	\$19.95
<b>PLENUM-RATED</b>					
550F11	E84 1 Bridge, 1 Base, 1 Screw/Bag	BI	25	100	\$4.15



550-11E



550F11

**TD+™**

**Large Universal Pipe Clamp**

**Related Products**

TD+™ Commercial Overhead Hangers p 539



550-2112

Item Number	Item Description	Pkg Type	Min Qty	Case Qty	Price
<b>STANDARD</b>					
550-2111	TD+ Clamp Base, Bridge And Screws, 1/Bag	BI	50	50	\$3.57
550-2111PK3	50 Bases, 50 Bridges, 100 Screws (Contr Pack) Bulk	B	1	1	\$178.50
550-2112	TD+ Clamp Base, 2 Bridges And Screws	BI	5	25	\$4.53

**HangsTuff Jr.™**

Item Number	Item Description	Pkg Type	Min Qty	Case Qty	Price
553-22W	XX 1/2" x 1/2" CTS	B	50	150	\$1.34
553-23W	XX 1/2" x 3/4" CTS	B	50	150	\$1.49
553-2W	1/2" CTS	CI	50	50	\$0.90
553-3W	3/4" CTS	CI	50	50	\$0.99
553-4W	1" CTS	CI	50	50	\$1.11
553-5W	1-1/4" CTS	CI	50	50	\$1.24



553-22W

**Single Hole Tube Strap**

Item Number	Item Description	Pkg Type	Min Qty	Case Qty	Price
550-02	1/2" CTS, 100/Bag	BI	1	10	\$18.48



550-02

Supply

Drainage

Support

Specialties

Appendix



# **Metal CTS/IPS**

**Two-Hole Tube Strap**

**Vinyl-Coated Steel Clamp**

**Wire Pipe Hooks**

**Milford/Natick Hangers**





2-Hole Tube Strap

Item Number	Item Description	Pkg Type	Min Qty	Case Qty	Price
<b>COPPER</b>					
500-2	1/2" CTS w/ Nails	B	100	500	\$0.52
<b>COPPER-PLATED</b>					
501-0	1/4" CTS w/ Nails	B	500	500	\$0.19
501-1	3/8" CTS w/ Nails	B	500	500	\$0.20
501-2	1/2" CTS w/ Nails	B	500	500	\$0.21
501-2PK	1/2" CTS	CI	100	100	\$0.46
501-2PK2	1/2" CTS, 10/Bag	CI	10	10	\$2.87
501-2PK3	1/2" CTS, (Contr Pack), 100/Bag	BI	1	10	\$21.20
501-3	3/4" CTS w/ Nails	B	500	500	\$0.26
501-3PK	3/4" CTS	CI	100	100	\$0.51
501-3PK2	3/4" CTS, 10/Bag	CI	10	10	\$3.35
501-3PK3	3/4" CTS, (Contr Pack), 100/Bag	BI	1	10	\$26.00
501-4	1" CTS w/ Nails	B	100	100	\$0.36
501-4PK	1" CTS	CI	100	100	\$0.61
501-5	1-1/4" CTS w/ Nails	B	100	100	\$0.54
501-5PK	1-1/4" CTS	CI	100	100	\$0.79
501-6	1-1/2" CTS w/ Nails	B	100	100	\$0.59
501-6PK	1-1/2" CTS	CI	100	100	\$0.84
501-7	2" CTS w/ Nails	B	100	100	\$0.64
<b>GALVANIZED</b>					
502-1	3/8" IPS	B	100	100	\$0.22
502-2	1/2" IPS	B	100	100	\$0.25
502-2PK2	1/2" IPS, 10/Bag	CI	10	10	\$3.25
502-3	3/4" IPS	B	100	100	\$0.30
502-3PK2	3/4" IPS, 10/Bag	CI	10	10	\$3.75
502-4	1" IPS	B	100	100	\$0.45
502-4PK2	1" IPS, 4/Bag	CI	10	10	\$2.55
502-5	1-1/4" IPS	B	50	50	\$0.63
502-5PK2	1-1/4" IPS, 4/Bag	CI	10	10	\$3.27
502-6	1-1/2" IPS	B	50	50	\$0.68
502-6PK2	1-1/2" IPS, 4/Bag	CI	10	10	\$3.47
502-7	2" IPS	B	50	50	\$0.92
502-75	2-1/2" IPS	B	25	25	\$1.89
502-7PK	2" IPS	CI	50	50	\$1.16
502-8	3" IPS	B	25	25	\$2.27
502-8PK	3" IPS	CI	15	15	\$2.52
502-9	4" IPS	B	25	25	\$2.73
502-9PK	4" IPS	CI	10	10	\$2.98



500-2



501-2



502-2

Vinyl-coated Steel Clamp with Screw

· Not for use with CPVC pipe or fittings

Item Number	Item Description	Pkg Type	Min Qty	Case Qty	Price
523-31	3/8" Nominal w/ Screw	B	100	1000	\$1.16
523-32	1/2" Nominal w/ Screw	B	100	1000	\$1.27
523-33	3/4" Nominal w/ Screw	B	50	500	\$1.33
523-34	1" Nominal w/ Screw	B	50	500	\$1.42



523-32

Supply

Drainage

Support

Specialties

Appendix

Supply



506-34

Drainage



506-36C

Support



506-34P

Specialties

Appendix



512-36PK



513-26PK

## Wire Pipe Hook

· Vinyl-coated models are not for use with CPVC pipe or fittings

Item Number	Item Description	Pkg Type	Min Qty	Case Qty	Price
<b>PLAIN STEEL</b>					
506-26	1/2" IPS × 6"	B	50	500	\$0.44
506-26PK2	1/2" IPS × 6" 5/Pack	CI	5	5	\$4.60
506-34	3/4" IPS × 4"	B	50	500	\$0.37
506-36	3/4" IPS × 6"	B	50	500	\$0.47
506-36PK2	3/4" IPS × 6" 5/Pack	CI	5	5	\$4.80
506-46	1" IPS × 6"	B	50	500	\$0.50
506-46PK2	1" IPS × 6" 5/Pack	CI	5	5	\$5.10
506-56	1-1/4" IPS × 6"	B	50	500	\$0.59
<b>COPPER-PLATED STEEL</b>					
506-26C	1/2" IPS × 6"	B	50	500	\$0.59
506-26CPK2	1/2" IPS × 6" 5/Pack	CI	5	5	\$3.70
506-36C	3/4" IPS × 6"	B	50	500	\$0.61
506-36CPK2	3/4" IPS × 6" 5/Pack	CI	5	5	\$3.80
506-46C	1" IPS × 6"	B	50	500	\$0.62
506-46CPK2	1" IPS × 6" 5/Pack	CI	5	5	\$3.85
<b>VINYL-COATED STEEL</b>					
506-26P	1/2" IPS × 6"	B	50	500	\$0.77
506-34P	3/4" IPS × 4"	B	50	500	\$0.66
506-36P	3/4" IPS × 6"	B	50	500	\$0.81
506-38P	3/4" IPS × 8"	B	50	500	\$1.00
506-46P	1" IPS × 6"	B	50	500	\$0.87

## Milford Hanger

### Epoxy-Coated Steel

Item Number	Item Description	Pkg Type	Min Qty	Case Qty	Price
512-26PK	1/2" CTS × 6"	BI	50	50	\$2.59
512-36PK	3/4" CTS × 6"	BI	50	50	\$2.72
512-46PK	1" CTS × 6"	BI	50	50	\$2.93

## Natick Hanger

### Epoxy-Coated Steel

Item Number	Item Description	Pkg Type	Min Qty	Case Qty	Price
513-26PK	1/2" CTS × 6"	BI	25	25	\$3.47
513-36PK	3/4" CTS × 6"	BI	25	25	\$3.56



# **Anchors & Fasteners**

**Anchors, Screws & Fasteners**

**Thread Rod Anchors**

**StainlessStar™**

**Cable Ties**

**Stainless Steel  
Bands**





**Anchors, Screws and Fasteners**

Item Number	Item Description	Pkg Type	Min Qty	Case Qty	Price
<b>ANCHORS</b>					
590-10	Kit: 100 #10×1"X 5/16" Hex/Phillips Screws, 100 Plastic Anchors And One 1/4" Carbide Bit	Bl	10	10	\$14.36
<b>SCREWS</b>					
591-06B	#6 × 1" Yellow Zinc-Plated, Coarse-Thread Wood Screw, 100/Bag	Bl	10	10	\$3.56
591-081	#8 × 1" Zinc-Plated Drill-Tip Phillips Screw, 100/Bag	B	10	10	\$7.64



590-10



591-06B

**Sioux Chief Sammys - Thread Rod Anchors**

Accepts 3/8" Thread Rod

Item Number	Item Description	Pkg Type	Min Qty	Case Qty	Price
<b>WOOD APPLICATIONS</b>					
590-4411	1/4" × 2" Screw, Vertical, 25/Box	Bl	1	5	\$45.48
590-4411-3	1/4" × 3" Screw, Vertical, 25/Box	Bl	1	5	\$47.14
590-4421	1/4" × 2" Screw, Horizontal, 25/Box	Bl	1	5	\$56.29
<b>CONCRETE APPLICATIONS</b>					
590-4412	1/4" × 1-3/4" Screw, Vertical, 25/Box	Bl	1	5	\$52.51
<b>STEEL BEAM APPLICATIONS</b>					
590-4413	1/4" × 2" Screw, Vertical, 25/Box	Bl	1	5	\$46.30
590-4423	1/4" × 1-1/4" Screw, Horizontal, w/ Nut, 25/Box	Bl	1	5	\$68.23
<b>INSTALLATION TOOLS</b>					
590-44ND1	Nut Driver #14 For Vertical Anchors (Black), 1/Bag	Bl	1	12	\$24.25
590-44ND2	Nut Driver #14SW For Horizontal Anchors (Red), 1/Bag	Bl	1	12	\$24.25



590-4411



590-4412



590-4413



590-44ND1

Supply

Drainage

Support

Specialties

Appendix



612-2S

## StainlessStar™

### Tube Locking One-Way Push Nut

· For copper tube only

Item Number	Item Description	Pkg Type	Min Qty	Case Qty	Price
612-2S	1/2" Copper Tube	B	50	500	\$2.04
612-3S	3/4" Copper Tube	B	25	250	\$2.14
612-4S	1" Copper Tube	B	25	250	\$2.49



554-08

## Cable Ties

### Durable Non-Corrosive Nylon

Item Number	Item Description	Pkg Type	Min Qty	Case Qty	Price
<b>STANDARD</b>					
554-08	8" × 3/16"	B	100	2500	\$0.09
554-14	14-1/2" × 3/16"	B	100	1000	\$0.24
554-14H	14-1/2" × 5/16"	B	100	1000	\$0.47
554-21	21" × 5/16"	B	50	500	\$0.74
554-36	36" × 5/16"	B	50	250	\$1.01



574-72

## Stainless Steel Bands

Item Number	Item Description	Pkg Type	Min Qty	Case Qty	Price
574-710	10" Diameter Snap-Lock Stainless Steel Band	B	10	10	\$7.65
574-713	13" Diameter Snap-Lock Stainless Steel Band	B	10	10	\$10.33
574-72	5" Diameter Standard Stainless Steel Band	B	50	50	\$3.16
574-74	4" Diameter Snap-Lock Stainless Steel Band	B	50	50	\$3.97
574-75	5" Diameter Snap-Lock Stainless Steel Band	B	50	50	\$4.94
574-77	7" Diameter Snap-Lock Stainless Steel Band	B	50	50	\$5.63

# **DWV Hangers**

**Extension Hangers**

**Hanger Straps**

**Ground Stakes**

# DWV Hangers

## Extension Hangers

Strong, rigid extension hangers for DWV pipe. Made from corrosion and impact resistant polymers, or coated steel, hangers are designed to make properly supporting DWV lines faster and easier. Select items designed in accordance with IAPMO PS 95-2018e3 Standard for Pipe Support Hangers and Hooks.

## Hanger Straps

Hanger strap is available in plastic and metal, as well as our innovative ApeTape™ woven poly fabric strap. ApeTape™ is strong, highly flexible, and corrosion proof. Available in 10, 25, 50 or 100-ft rolls for any job size. Select items designed in accordance with IAPMO PS 95-2018e3 Standard for Pipe Support Hangers and Hooks.

## Ground Stakes

Ground stakes to prevent on-grade DWV pipes from moving, shifting or floating during concrete pours. Available with a plastic head, or an all-steel version.

# Extension Hangers

**HangsTuff™**

**Swivel J-Hanger™**

**Gas Vent Pipe Support**

**ZipStick™**

**Metal DWV**

**StickEm Up™**

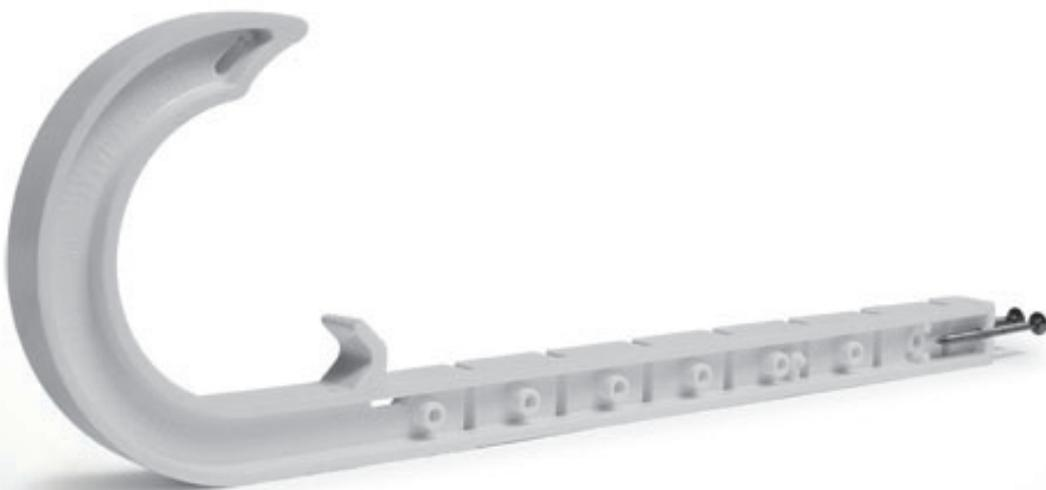

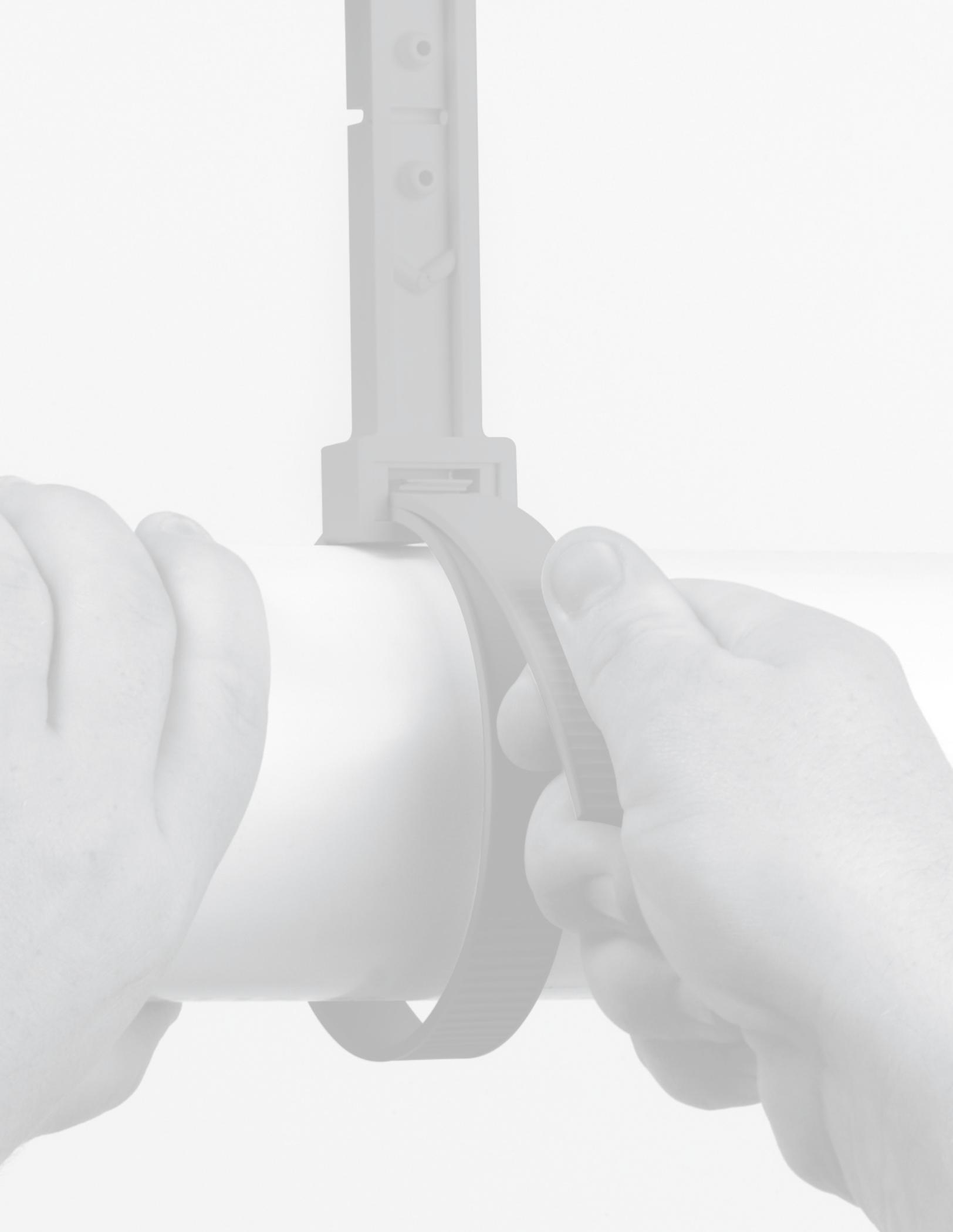



**HangsTuff™**

**DWV Pipe Hanger**

Item Number	Item Description	Pkg Type	Min Qty	Case Qty	Price
<b>WHITE</b>					
553-6W	1-1/2" Sch. 40, w/ Pre-Loaded Nails	BI	50	50	\$1.11
553-6WM25	1-1/2" Sch. 40, Megapac: 25 Hooks And 50 Bulk Nails Per Bag	BI	10	10	\$25.97
553-7W	2" Sch. 40, w/ Pre-Loaded Nails	BI	50	50	\$1.16
553-830W	3" Sch. 30, w/ Pre-Loaded Nails	BI	50	50	\$1.47
553-8W	3" Sch. 40 w/ Pre-Loaded Nails	BI	50	50	\$1.32
553-8WM25	3" Sch. 40 Megapac: 25 Hooks And 50 Bulk Nails Per Bag	BI	10	10	\$31.27
553-9W	4" Sch. 40, w/ Pre-Loaded Nails	BI	25	25	\$1.49
<b>ACCESSORIES</b>					
521-210	3/8" ATR Extension Stainless Steel L-Bracket w/ Screws	BI	25	25	\$2.04



553-6W

**Swivel J-Hanger™**

**DWV Hanger**

Item Number	Item Description	Pkg Type	Min Qty	Case Qty	Price
553-6WZ	1-1/2" Sch 40, Nails Included	B	25	100	\$1.68
553-6WZPK2	1-1/2" Sch 40, Nails Included, 4/Bag	BI	4	5	\$7.47
553-7WZ	2" Sch 40, Nails Included	B	25	100	\$1.75
553-7WZPK2	2" Sch 40, Nails Included, 4/Bag	BI	4	5	\$7.75
553-8WZ	3" Sch 40, Nails Included	B	25	100	\$2.13
553-8WZPK2	3" Sch 40, Nails Included, 4/Bag	BI	4	5	\$9.27
553-9WZ	4" Sch 40, Nails Included	B	25	100	\$2.27
553-9WZPK2	4" Sch 40, Nails Included, 4/Bag	BI	4	5	\$9.83



553-6WZ

**Gas Vent Pipe Support**

**Type B Pipe Support**

Item Number	Item Description	Pkg Type	Min Qty	Case Qty	Price
549-810	5" Metal Vent Support	B	6	6	\$10.10
549-811	6" Metal Vent Support	B	6	6	\$11.19



549-808

**ZipStick™**

**Universal Pipe Hanger**

Item Number	Item Description	Pkg Type	Min Qty	Case Qty	Price
<b>GRAY</b>					
553-014	14"	B	100	100	\$3.47
553-014PK	14"	BI	25	25	\$3.72
553-026	26"	B	50	50	\$5.41
553-STRP	Strap Only	B	50	50	\$1.82



553-014

Supply

Drainage

Support

Specialties

Appendix



521-210



510-7PK



510-6VPK



549-712

## ZipStick™ (Cont)

### Universal Pipe Hanger

Item Number	Item Description	Pkg Type	Min Qty	Case Qty	Price
<b>L-BRACKET ACCESSORY</b>					
521-210	3/8" ATR Extension Stainless Steel L-Bracket w/ Screws	BI	25	25	\$2.04

## Metal DWV Hanger

· Vinyl-coated models are not for use with CPVC pipe or fittings

Item Number	Item Description	Pkg Type	Min Qty	Case Qty	Price
<b>GALVANIZED</b>					
510-6PK	1-1/2" Sch 40	CI	20	20	\$3.22
510-7PK	2" Sch 40	CI	20	20	\$3.44
510-8PK	3" Sch 40	CI	20	20	\$5.24
510-9PK	4" Sch 40	CI	20	20	\$5.67
<b>VINYL-COATED GALVANIZED STEEL</b>					
510-6VPK	1-1/2" Sch 40	CI	10	10	\$5.77
510-7VPK	2" Sch 40	CI	10	10	\$7.55
510-8VPK	3" Sch 40	CI	10	10	\$8.51
510-9VPK	4" Sch 40	CI	10	10	\$10.06

## StickEm Up™

### Dual-Sized DWV Stanchion Pipe Support

Item Number	Item Description	Pkg Type	Min Qty	Case Qty	Price
549-712	1-1/2"- 2" Sch 40	B	50	50	\$2.53
549-734	3"- 4" Sch 40	B	25	25	\$2.61

# Hangar Straps

ApeTape™

Plastic

Metal



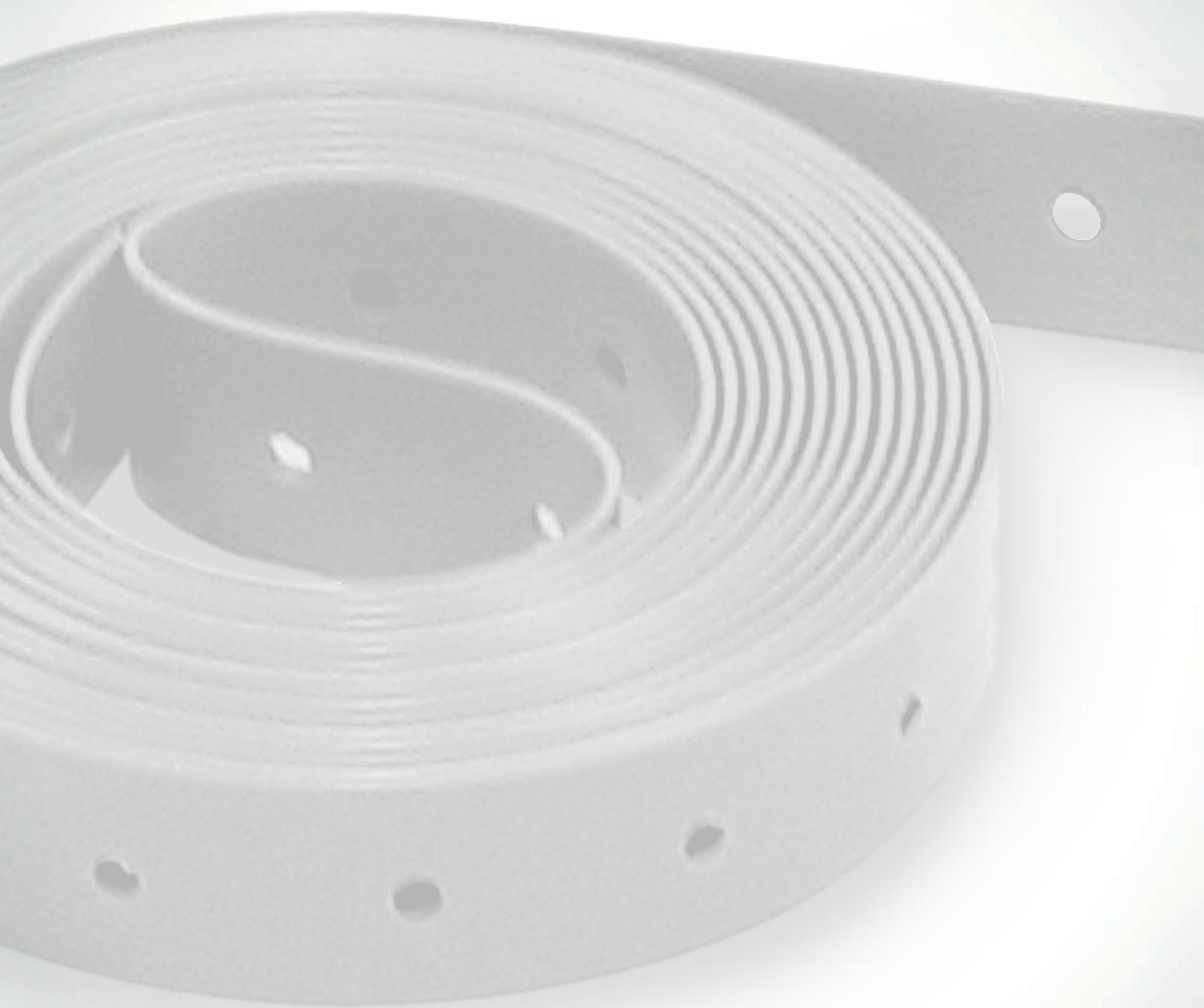

**ApeTape™**

**Woven Polypropylene Hanger Strap**

Item Number	Item Description	Pkg Type	Min Qty	Case Qty	Price
554-100W	5/8" × 100', 1/Bag	Bl	1	20	\$16.24
554-25W	5/8" × 25', 1/Bag	Bl	1	20	\$4.65



554-100W

**Plastic Hanger Strap**

**Polypropylene with 1/8" Holes**

Item Number	Item Description	Pkg Type	Min Qty	Case Qty	Price
554-100	3/4" × 100', 1/Bag	Bl	1	20	\$17.13
554-10PK2	3/4" × 10', 1/Bag	Cl	10	10	\$3.02
554-25	3/4" × 25', 1/Bag	Bl	1	20	\$5.03



554-100

**Metal Hanger Strap**

Item Number	Item Description	Pkg Type	Min Qty	Case Qty	Price
<b>GALVANIZED STEEL WITH ALTERNATING 1/4" AND 3/16" HOLES</b>					
524-10	3/4" × 10' Coil, 24-Ga	B	50	50	\$3.02
524-100	3/4" × 100' Coil 24-Ga, 1/Box	B	5	5	\$28.50
524-1022PK2	3/4" × 10' Coil 22-Ga, 1/Bag	Cl	10	50	\$4.12
524-10PK	3/4" × 10' Coil 24-Ga IBC	Bl	50	50	\$3.27
524-10PK2	3/4" × 10' Coil 24-Ga, 1/Bag	Cl	10	10	\$3.52
524-50	3/4" × 50' Coil 24-Ga, 1/Box	B	10	10	\$14.27
524-50PK3	3/4" × 50' Coil 24-Ga, (Contr Pack), 1/Box	Bl	1	10	\$14.27
528-10	3/4" × 10' Coil, 28-Ga	B	50	50	\$2.95
528-100	3/4" × 100' Coil, 28-Ga, 1/Box	B	5	5	\$27.13
528-10PK	3/4" × 10' Coil, 28-Ga IBC	Bl	50	50	\$3.20
528-10PK2	3/4" × 10' Coil, 28-Ga, 1/Bag	Cl	10	10	\$3.45
528-25PK2	3/4" × 25' Coil, 28-Ga, 1/Bag	Cl	1	12	\$6.83
528-50	3/4" × 50' Coil, 28-Ga, 1/Box	B	10	10	\$13.57
<b>COPPER-PLATED STEEL WITH ALTERNATING 1/4" AND 3/16" HOLES</b>					
524-10CPK2	3/4" × 10' Coil, 24-Ga, 1/Bag	Cl	10	10	\$9.64



524-10



524-10CPK2

Supply

Drainage

Support

Specialties

Appendix



# Ground Stakes

Tomahawk™

Simple and effective - the Tomahawk™ keeps ground-rough DWV pipe securely in place before and during the concrete pour.







**Tomahawk™**

**DWV Ground Stake**

Item Number	Item Description	Pkg Type	Min Qty	Case Qty	Price
<b>POLYETHYLENE HEAD</b>					
535-914	3/8" × 14" Rebar w/ Poly Head	B	25	25	\$4.21
535-926	3/8" × 26" Rebar w/ Poly Head	B	25	25	\$5.74
535-9P	Poly Head Only (Fits #3 Rebar)	B	50	50	\$0.98
<b>ALL STEEL</b>					
535-14	3/8" × 14" All Steel	B	25	25	\$5.30



Supply

Drainage

Support

Specialties

Appendix



# **Brackets**

**Stub Out Brackets**

**Bend Supports**

**Universal Brackets**

**Adjustable/Multi-Purpose  
Brackets**

**Commercial Brackets**

**Overhead Brackets**

**Stud Guards & Safety Plates**

**Water Heater Accessories**

# Brackets

## Stub Out Brackets

Sioux Chief offers a multitude of easy-to-install, galvanized and copper-plated brackets designed to keep any type of stub out mounted securely in the stud cavity. Stub out brackets offer a cost-effective solution to finding/measuring/cutting blocks of wood.

## Bend Supports

Plastic and metal bend supports available for use with 1/2" and 3/4" PEX tube. Bend supports help prevent kinks in PEX tube and allow tighter-radius bends without using elbow fittings.

## Universal Brackets

Sioux Chief's PowerBar™ system adjusts 'telescopically' to accommodate almost any stud or joist opening. Acoustical models reduce the transfer of waterline noise to the building members.

## Adjustable/Multi-Purpose Brackets

Cost-effective galvanized or copper-plated flat and adjustable brackets available for a variety of applications.

## Commercial Brackets

Brackets designed to meet the demands of commercial projects. Mini Strut options offer a versatile alternative to cutting, installing, and securing pipe or tube to standard strut products. Unique clamps and other accessories available, including the TD+™ system with acoustical and plenum-rated models available.

## Overhead Brackets

Simple, galvanized and copper-plated clamps for hanging and supporting pipe/tube overhead. Threaded rod, anchors, and other accessories available.

## Stud Guards & Safety Plates

Guards and plates offer code-required protection of plumbing lines inside walls or support for notched studs.

## Water Heater Accessories

Easy-to-assemble, galvanized water heater stands keep appliances off the floor, and convenient support kits hold expansion tanks securely in place where needed.

# Stub Out Brackets

**StrongArm™**

**Edge™ Bracket**

**SecureAll™**

**Stub Out Brackets**

**Stub Out Brackets  
with Stud Guard**

**Solder Straps**

Sioux Chief's popular StrongArm™ bracket bends to mount in standard, narrow, or oddly-shaped stud cavities, while the unique LockBlock™ device keeps any copper, PEX, or CPVC stub out *rock* solid.

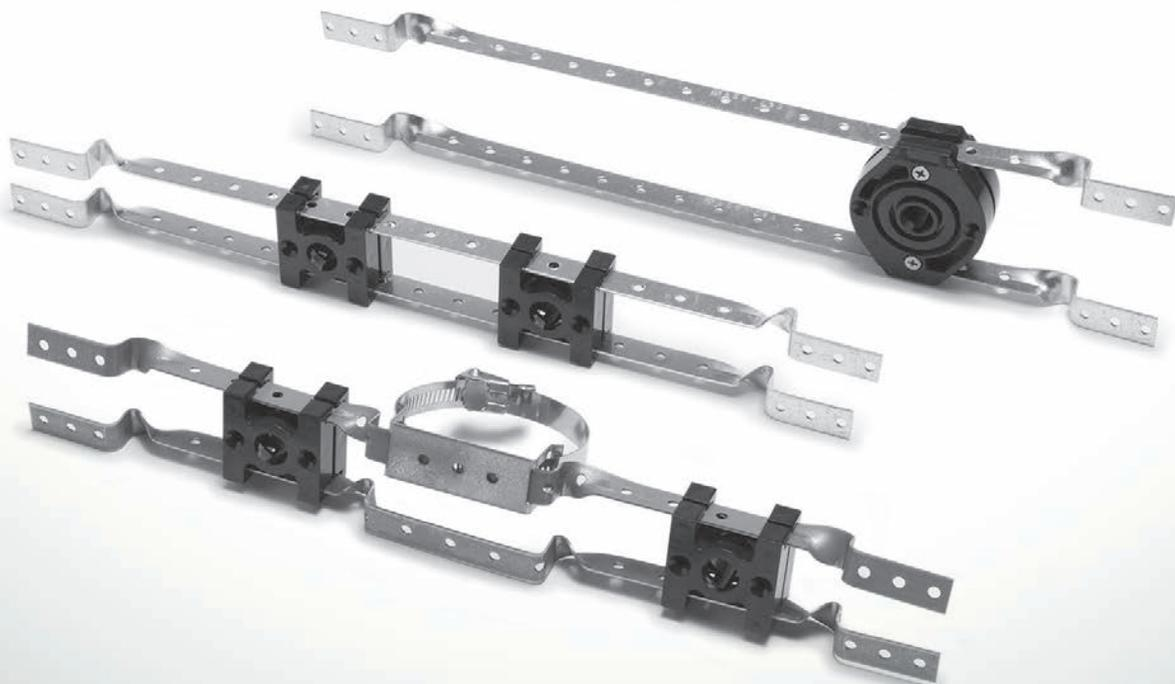



**525-1612**  
Page 519



**525-P2M1**  
Page 519



**525-B2**  
Page 519



**525-16WLB**  
Page 520



**525-WLB**  
Page 520



**525-162PBV**  
Page 520



**520-EC2**  
Page



**521-851**  
Page 520



**521-118**  
Page 521



**521-3725B**  
Page 521



**521-6416**  
Page 521



**505-24**  
Page 522



**550-MP2**  
Page 525



**550-PC2**  
Page 525



**550-FP2**  
Page 525



**523-2414**  
Page 529



**522-5501**  
Page 530



**523-712W**  
Page 530



**520-616**  
Page 533



**520-19**  
Page 533



**525-02**  
Page 533



**525-6920**  
Page 533



**525-20B**  
Page 519

**StrongArm™**

**LockBlock™ or PEX Bend LockBlock™**

Item Number	Item Description	Pkg Type	Min Qty	Case Qty	Price
<b>BRACKET ASSEMBLIES FOR 16" STUD BAYS</b>					
525-1612	Twisted Brackets w/ One 1/2" Lockblock™	B	25	25	\$5.46
525-1613	Twisted Brackets w/ One 3/4" Lockblock™	B	25	25	\$5.85
525-1614	Twisted Brackets w/ One 1" Lockblock™	B	25	25	\$5.99
525-161PB	Twisted Brackets w/ One 1/2" PEX Bend Lockblock™	BI	25	25	\$7.47
525-161PBL	L-Bent Brackets w/ One 1/2" PEX Bend Lockblock™	B	25	25	\$7.47
525-161PBPBK	Twisted Brackets w/ One 1/2" PEX Bend Lockblock™	CI	10	10	\$10.22
525-1622	Twisted Brackets w/ Two 1/2" Lockblock™	B	25	25	\$6.80
525-1622L	L-Bent Brackets w/ Two 1/2" Lockblock™	B	25	25	\$6.80
525-1622PK1	Twisted Brackets w/ Two 1/2" Lockblock™	CI	10	10	\$9.55
525-1623	Twisted Brackets w/ Two 3/4" Lockblock™	B	25	25	\$8.17
525-1624	Twisted Brackets w/ Two 1" Lockblock™	B	25	25	\$8.47
525-162PB	Twisted Brackets w/ Two 1/2" PEX Bend Lockblocks	BI	25	25	\$8.95
525-162PBL	L-Bent Brackets w/ Two 1/2" PEX Bend Lockblocks	B	25	25	\$8.95
525-162PBPBK	Twisted Brackets Assembly w/ Two 1/2" PEX Bend Lockblock™	CI	10	10	\$11.70
<b>BRACKET ASSEMBLIES FOR 24" STUD BAYS</b>					
525-2412	Twisted Brackets w/ One 1/2" Lockblock™	B	25	25	\$6.21
525-2413	Twisted Brackets w/ One 3/4" Lockblock™	B	25	25	\$6.45
525-241PB	Twisted Brackets w/ One 1/2" PEX Bend Lockblock™	B	25	25	\$8.36
525-241PBL	L-Bent Brackets w/ One 1/2" PEX Bend Lockblock™	B	25	25	\$8.36
525-2422	Twisted Brackets w/ Two 1/2" Lockblock™	B	25	25	\$7.54
525-242PB	Twisted Brackets w/ Two 1/2" PEX Bend Lockblock™	B	25	25	\$9.79
525-242PBL	L-Bent Brackets w/ Two 1/2" PEX Bend Lockblock™	B	25	25	\$9.63
<b>KITS</b>					
525-B2S	Bagged Kit: One 1/2" Lockblock™ w/ Two 2-1/2" Drill-Tip Screws	BI	50	50	\$2.75
525-B3S	Bagged Kit: One 3/4" Lockblock™ w/ Two 2-1/2" Drill-Tip Screws	BI	50	50	\$3.24
525-P2M1	Bagged Kit: One 1/2" PEX Bend Lockblock™ w/ Galvanized Face Plate	BI	25	25	\$4.79
<b>ACCESSORIES AND BULK COMPONENTS</b>					
525-16T	Twisted Bracket For 16" Stud Bays	B	100	100	\$1.71
525-20B	L-Bent Bracket For 16" Stud Bays	B	100	100	\$1.63
525-24T	Twisted Bracket For 24" Stud Bays	B	100	100	\$1.91
525-B2	1/2" Lockblock™ w/ Screws	B	50	50	\$1.76
525-B3	3/4" Lockblock™ w/ Screws	B	50	50	\$2.07
525-B4	1" Lockblock™ w/ Screws	B	50	50	\$2.19
525-P2	1/2" PEX Bend Only	B	50	50	\$1.63
525-P22	1/2" PEX Bend Lockblock™ (3-Piece Assembly)	B	50	50	\$2.57
525-P2M	Lockblock™ Face Plate	B	100	100	\$2.19
525-P2PK	1/2" PEX Bend Only	CI	10	10	\$1.88
591-06B	#6 × 1" Yellow Zinc-Plated, Coarse-Thread Wood Screw, 100/Bag	BI	10	10	\$3.56
591-081	#8 × 1" Zinc-Plated Drill-Tip Phillips Screw, 100/Bag	B	10	10	\$7.64



525-241PBL



525-P2M1

Supply

Drainage

Support

Specialties

Appendix

Supply



525-16WLB

Drainage



525-WLB

Support



525-1622V

Specialties



525-162PBV

Appendix



520-EC2



521-851

### StrongArm™

#### Shower WallNut™ LockBlock™

Related Products  
Shower WallNut™ p 640

Item Number	Item Description	Pkg Type	Min Qty	Case Qty	Price
525-16WLB	Twisted Brackets w/ One Shower Wallnut™ Lockblock™ For 1/2" Copper Ell	B	25	25	\$6.92
<b>BULK COMPONENTS</b>					
525-WLB	1/2" Shower Wallnut™ Lockblock™	B	50	50	\$2.54

### StrongArm™

#### Vent Support

Item Number	Item Description	Pkg Type	Min Qty	Case Qty	Price
<b>WITH LOCKBLOCK™</b>					
525-1622V	Vent Pipe Assembly: SaddleUp™ Clamp, S/S Band & Two 1/2" Lockblock™	B	25	25	\$11.80
<b>WITH PEX BEND LOCKBLOCK™</b>					
525-162PBV	Vent Pipe Assembly: SaddleUp™ Clamp, S/S Band & Two 1/2" PEX Bend Lockblock™	B	25	25	\$13.95

### Edge™ Support System

#### Copper-Plated and Galvanized Angle Brackets

Item Number	Item Description	Pkg Type	Min Qty	Case Qty	Price
<b>COMPONENTS</b>					
520-E16	Galvanized Bracket For 16" Stud Bays	B	100	100	\$1.63
520-E24	Galvanized Bracket For 24" Stud Bays	B	100	100	\$2.67

### Secure-All™

#### Copper-Plated Stub Out Bracket

Item Number	Item Description	Pkg Type	Min Qty	Case Qty	Price
521-851	2" × 20" 18-Ga. For 1/2", 3/4" And 1" Copper, Extruded Holes	B	50	50	\$6.36
521-851PK	2" × 20" 18-Ga. For 1/2", 3/4" And 1" Copper, Extruded Holes	CI	25	25	\$6.86
521-852	2-3/8" × 26" 18-Ga. For 1/2", 3/4" And 1" Copper, Extruded Holes	B	50	50	\$7.76



Stub Out Bracket

- Heat the tube, not the bracket

Related Products

PipeEye™ Insulators p 489

Item Number	Item Description	Pkg Type	Min Qty	Case Qty	Price
<b>COPPER-PLATED</b>					
521-118	1-1/4" x 20" 16-Ga. For 1/2" Copper	B	50	50	\$5.81
521-118R	1-1/4" x 20" 16-Ga. For 1/2" Copper w/ Extruded Holes	B	25	25	\$6.14
521-126	1-1/4" x 26" 16-Ga. For 1/2" Copper	B	50	50	\$8.75
521-810	1-3/4" x 20" 16-Ga. For 1/2", 3/4" And 1" Copper	B	50	50	\$6.91
521-810PK	1-3/4" x 20" 16-Ga. For 1/2", 3/4" And 1" Copper	Cl	50	50	\$7.41
521-820	1-3/4" x 20" 24-Ga. For 1/2", 3/4" And 1" Copper w/ Extruded Holes	B	50	50	\$6.52
<b>GALVANIZED - FOR USE WITH PIPEEYE™ INSULATORS</b>					
521-318	2" x 20" 14-Ga.	B	50	50	\$4.84
521-360	2" x 26" 14-Ga.	B	50	50	\$5.87
521-3725B	3" x 4-3/4" L-Bracket, 14-Ga.	B	100	100	\$2.14



521-118



521-3725B

Stub Out Bracket with Stud Guard

Copper-Plated

Item Number	Item Description	Pkg Type	Min Qty	Case Qty	Price
521-6415	1/2" Or 3/4" Copper, Extruded Holes & Nail Spikes, 16-Ga	B	25	25	\$4.63
521-6416	1/2" Or 3/4" Copper, Extruded Holes & Pre-Drilled Holes, 16-Ga.	B	25	25	\$4.63



521-6416

Supply

Drainage

Support

Specialties

Appendix

Supply

Drainage

Support

Specialties

Appendix



505-24



505-39



505-5

### Solder Straps

#### Copper-earred Tube Hanger

Item Number	Item Description	Pkg Type	Min Qty	Case Qty	Price
<b>SQUARE O™ STRAP</b>					
505-24	1/2" Copper	B	100	100	\$0.80
505-34	3/4" Copper	B	100	100	\$0.85
505-44	1" Copper	B	50	50	\$0.99
<b>SOLDER O™ STRAP</b>					
505-29	1/2" Copper	B	100	100	\$0.98
505-39	3/4" Copper	B	100	100	\$1.07
505-49	1" Copper	B	50	50	\$1.27
<b>SOLDER C™ STRAP</b>					
505-5	1-1/4" Copper	B	25	100	\$1.51

# Bend Supports

**SideWinder™**

**Simple Bend Support**

**PEXChair™**

**PEX Sleeve**

**PEX Bend Support**





**SideWinder™**

**Related Products**

StrongArm™ w/ PEX Bend LockBlock™ p 519

Item Number	Item Description	Pkg Type	Min Qty	Case Qty	Price
<b>METAL BEND SUPPORTS</b>					
550-M2	Metal 1/2" PEX Bend Support	B	50	50	\$1.61
550-M3	Metal 3/4" PEX Bend Support	B	25	25	\$2.75
550-MP2	Metal 1/2" PEX Bend Support w/ Plate	B	25	25	\$5.34
550-MP2PK	Metal 1/2" PEX Bend Support w/ Plate	Cl	10	10	\$6.09
550-MP3	Metal 3/4" PEX Bend Support w/ Plate	B	25	25	\$6.14



550-MP2

**Simple Bend Support**

Item Number	Item Description	Pkg Type	Min Qty	Case Qty	Price
550-PB2	Plastic 1/2" PEX Bend Support	B	50	50	\$1.33
550-PB3	Plastic 3/4" PEX Bend Support	B	50	50	\$3.59



550-PB2

**PexChair™**

Item Number	Item Description	Pkg Type	Min Qty	Case Qty	Price
550-PC2	1/2" PEXchair™ Slab Organizer	B	10	10	\$14.13



550-PC2

**Through-Floor Protective Sleeve**

Item Number	Item Description	Pkg Type	Min Qty	Case Qty	Price
550-FP2	1/2" CTS Protective Floor Sleeve	B	25	25	\$6.12
550-FP2S	1/2" CTS Protective Floor Sleeve (Short)	B	25	25	\$5.67



550-FP2

Supply

Drainage

Support

Specialties

Appendix



# Universal Brackets

PowerBar™

Sioux Chief's PowerBar™ is designed for ultimate versatility with preloaded, multi-size TouchDown™ clamps. Adjustable and fixed-length brackets with a full line of accessories make it perfect for nearly any application.

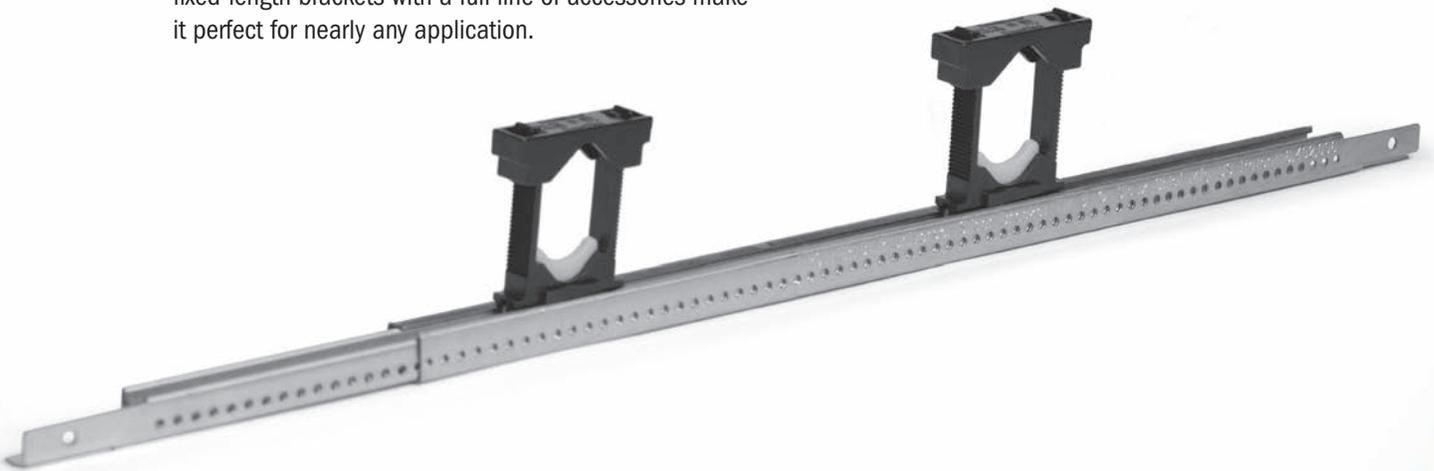





**PowerBar™**

**Universal Slider Bracket**

· Clamps 1/4" - 1" CTS tube & 1/8" - 1" Sch. 40 pipe

Item Number	Item Description	Pkg Type	Min Qty	Case Qty	Price
<b>9" - 16" ADJUSTABILITY</b>					
523-16	Bracket Only	B	50	50	\$4.18
523-1604	1 Bracket, 6 Drill-Tip Screws	B	50	50	\$4.67
523-1610	1 Bracket, 1 TouchDown Clamp	B	50	50	\$5.21
523-1614	1 Bracket, 1 TouchDown Clamp w/ Screws	B	50	50	\$5.70
523-1620	1 Bracket, 2 TouchDown Clamps	B	50	50	\$5.86
523-1620PK1	1 Bracket, 2 TouchDown Clamps	Cl	10	10	\$8.61
523-1624	1 Bracket, 2 TouchDown Clamps w/ Screws	B	50	50	\$6.33
523-1630	1 Bracket, 3 TouchDown Clamps	B	50	50	\$6.87
523-1634	1 Bracket, 3 TouchDown Clamps w/ Screws	B	50	50	\$7.43
<b>14" - 26" ADJUSTABILITY</b>					
523-24	Bracket Only	B	50	50	\$5.42
523-2404	1 Bracket, 6 Drill-Tip Screws	B	50	50	\$5.93
523-2414	1 Bracket, 1 TouchDown Clamp w/ Screws	B	50	50	\$6.98
523-2420	1 Bracket, 2 TouchDown Clamps	B	50	50	\$7.07
523-2424	1 Bracket, 2 TouchDown Clamps w/ Screws	B	50	50	\$7.66
523-2434	1 Bracket, 3 TouchDown Clamps w/ Screws	B	50	50	\$8.76
523F2424	Plenum-Rated Assembly: 1 Bracket, Two E84 Clamps w/ Screws	B	50	50	\$9.92
<b>KITS AND CONTRACTOR PACKS</b>					
523-162001	9"-16" Contr Pack 50 Brackets w/2 Clamps And 100 Bridges (Bulk) (No Screws)	B	1	1	\$284.75
523-162401	9"-16" Contr Pack 50 Brackets w/2 Clamps, 100 Bridges And 200 Screws (Bulk)	B	1	1	\$295.32
523-1K52000	Lav/Vent Assembly: 1 Bracket, 2 Clamps, 1 SaddleUp™ Clamp And S/S Band	B	10	10	\$9.52
523-242001	14"-24" Contr Pack 50 Brackets w/2 Clamps And 100 Bridges (Bulk) (No Screws)	B	1	1	\$347.43
523-242401	14"-24" Contr Pack 50 Brackets w/2 Clamps, 100 Bridges And 200 Screws (Bulk)	B	1	1	\$357.89
523-VLK1	Vent Loop Kit Assembly w/ 1 Clamp And 2 ComboSaddles	Bl	25	25	\$10.94
523-VLK2	Vent Loop Kit Assembly w/ 2 Clamps And 2 ComboSaddles	Bl	25	25	\$11.43



523-16



523-2414



523-VLK2

Supply

Drainage

Support

Specialties

Appendix

Supply

Drainage

Support

Specialties

Appendix



523-1634Q

**PowerBar™**  
**Acoustical**

Item Number	Item Description	Pkg Type	Min Qty	Case Qty	Price
522-100B	PipeDown™, 100 Inserts/Bag (Not For Use w/ Plenum-Rated Models)	B	1	10	\$46.57
522-100BPK2	PipeDown™, 10 Inserts/Bag (Not For Use w/ Plenum-Rated Models)	BI	1	10	\$5.16
523-1614Q	PipeDown™ Assembly: 1 Bracket, 1 Clamp w/ Cushions & Screws	B	25	25	\$6.96
523-1624Q	PipeDown™ Assembly: 1 Bracket, 2 Clamps w/ Cushions & Screws	B	25	25	\$7.38
523-1634Q	PipeDown™ Assembly: 1 Bracket, 3 Clamps w/ Cushions & Screws	B	25	25	\$9.15
523-16DEQ	PipeDown™ Assembly: 1 Bracket w/ 2 DE-90 Cushions	B	25	25	\$13.29
523-2424Q	PipeDown™ Assembly: 1 Bracket, 2 Clamps w/ Cushions & Screws	B	25	25	\$8.61
523-2434Q	PipeDown™ Assembly: 1 Bracket, 3 Clamps w/ Cushions & Screws	B	25	25	\$9.61
523-5500Q	PipeDown™ Acoustical TouchDown™ Clamp (Bulk)	B	100	100	\$1.39
523-5501Q	PipeDown™ Acoustical TouchDown™ Clamp (1 Set/Bag)	B	100	100	\$1.85
523-DEQ	PipeDown™ DE-90 Cushion (Bagged Set), 1 Pair/Bag	BI	1	25	\$8.40



523-712W

**PowerBar™**  
**Accessories and Bulk Components**

Item Number	Item Description	Pkg Type	Min Qty	Case Qty	Price
522-101	100 Bridges Only	B	100	100	\$0.25
522-102	100 Base Inserts Only	B	100	100	\$0.41
522-5500	100 Bases, 100 Bridges, 100 Base Inserts (Bulk)	B	100	100	\$0.64
522-5501	1 Bridge, 1 Clamp Base, 1 Base Insert (1 Set/Bag)	B	100	100	\$1.10
523-01	Ratchet-Locking ZipStrap™ w/ PowerBar Foot Adapter And Screw	B	50	50	\$2.69
523-1	SaddleUp™ Galvanized DWV Clamp	B	50	50	\$1.55
523-712W	ComboSaddle Fits 1-1/2" - 2" DWV	B	10	50	\$1.46
523-734W	ComboSaddle Fits 3"- 4" DWV	B	10	50	\$1.59
523F5500	Plenumsafe™ 100 Bases, 100 Bridges, 100 Base Inserts (Bulk)	B	100	100	\$2.62

# Adjustable & Multi-Purpose

**WiderSlider™**

**Slider™**

**SimpleStrap™**

**Support/Hyco Bars**



The durable WiderSlider™ bracket is made from galvanized 22-gauge steel. Pilot holes make it easier to install drop-ear elbows or other clamps. Bendable end tabs allow the bracket to set inside the stud cavity.



**WiderSlider™**

**Adjustable Multi-Purpose Bracket**

Item Number	Item Description	Pkg Type	Min Qty	Case Qty	Price
<b>9" - 15"</b>					
520-616	9" - 15" Galvanized Bracket	B	50	50	\$4.78
<b>13" - 23"</b>					
520-626	13"-23" Galvanized Bracket	B	50	50	\$6.29
520-626PK	13"-23" Galvanized Bracket	BI	10	10	\$6.54



520-616



520-626

**Slider™**

**Adjustable Multi-Purpose Bracket**

Item Number	Item Description	Pkg Type	Min Qty	Case Qty	Price
<b>12" - 19"</b>					
520-19	12"-19" Galvanized, Self-Nailing	B	50	50	\$2.07
520-19C	12"-19" Copper Plated, Self-Nailing	B	50	50	\$4.12
520-19CPK	12"-19" Copper Plated, Self-Nailing	CI	25	25	\$4.37
520-19PK	12"-19" Galvanized, Self-Nailing	CI	50	50	\$2.32
520-19T	12"-19" Galvanized, Flat Tabs And Pilot Holes	B	50	50	\$2.35
520-19TC	12"-19" Copper Plated, Flat Tabs And Pilot Holes	B	50	50	\$4.17
520-419	12"-19" Galvanized, Self-Nailing And Pilot Holes	B	50	50	\$4.56
520-419T	12"-19" Galvanized, Flat Tabs And Pilot Holes	B	50	50	\$4.56
520-419TC	12" - 19" Copper Plated, Flat Tabs And Pilot Holes	B	50	50	\$5.93
<b>19" - 24"</b>					
520-24	19"-24" Galvanized, 3-Piece Assembly	B	25	25	\$2.80

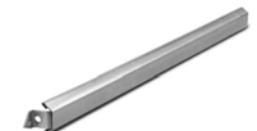

520-19



520-419

**SimpleStrap™**

**Cost-Effective Stub Out Bracket**

Item Number	Item Description	Pkg Type	Min Qty	Case Qty	Price
<b>CLAMPS</b>					
525-02	1/2" CTS Simplestrap™	B	100	1000	\$0.56
525-02G	1/2" CTS Simplestrap™, Glueable To CPVC	B	100	1000	\$0.56
525-03	3/4" CTS Simplestrap™	B	100	1000	\$0.63
525-2002PK2	Kit: 20" Galvanized Bracket w/ Two 1/2" CTS Straps	BI	50	50	\$3.89
<b>BRACKETS</b>					
525-6917	Flat Bracket, 17"	B	100	100	\$1.72
525-6920	Flat Bracket, 20"	B	100	100	\$1.90
525-6926	Flat Bracket, 26"	B	100	100	\$2.25



525-02



525-6920

Supply

Drainage

Support

Specialties

Appendix

**Support Bracket**

**Multi-Purpose Galvanized Bracket**

Item Number	Item Description	Pkg Type	Min Qty	Case Qty	Price
<b>L-BENT</b>					
525-20B	L-Bent Bracket For 16" Stud Bays	B	100	100	\$1.63
<b>FLAT</b>					
525-6917	Flat Bracket, 17"	B	100	100	\$1.72
525-6920	Flat Bracket, 20"	B	100	100	\$1.90
525-6926	Flat Bracket, 26"	B	100	100	\$2.25

Supply

Drainage

Support

Specialties

Appendix

# Commercial Brackets

**Bell Hanger**

**Carrier Bracket**

**Chase Bracket**

**PipeTitan™**

**PowerBar™ Mini Strut**

**SaddleUp™**

**TD+™ Universal Clamp**

**Acoustical**

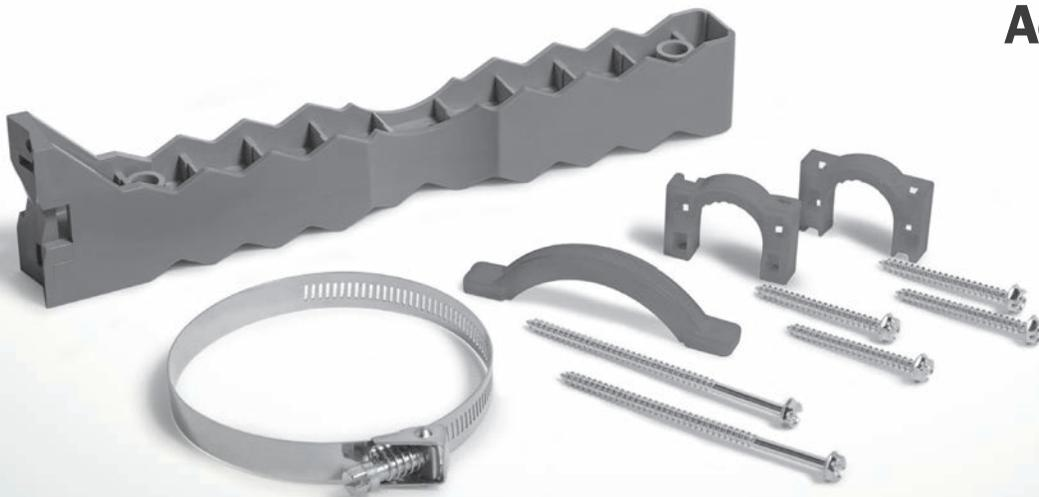



**508-2B**  
Page 537



**521-729**  
Page 537



**521-723**  
Page 537



**521-110**  
Page 537



**570-20**  
Page 538



**523-2MS2**  
Page 538



**523-1B**  
Page 539



**550-2111**  
Page 539

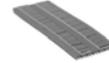

**575-102Q**  
Page 541



## CTS Bell Hanger

### Copper-Plated Steel

Item Number	Item Description	Pkg Type	Min Qty	Case Qty	Price
508-2B	1/2" CTS, Bulk	B	25	25	\$2.79
508-2PK	1/2" CTS, 1/Bag	CI	25	25	\$2.97
508-3B	3/4" CTS, Bulk	B	25	25	\$3.00
508-3PK	3/4" CTS, 1/Bag	CI	25	25	\$3.04
508-4B	1" CTS, Bulk	B	25	25	\$3.17
508-4PK	1" CTS, 1/Bag	CI	25	25	\$3.18



508-2B

## Carrier Bracket

### Copper-Plated

**Related Products**

Sweat Stub Out p 103

Item Number	Item Description	Pkg Type	Min Qty	Case Qty	Price
521-725	1" CTS × 4-1/2" Offset Centerline, Washers Included	B	5	5	\$16.55
521-728	1" CTS × 4-1/2" Offset Centerline For Prefab, Washers Included	B	5	5	\$16.55
521-729	1" CTS × 4-3/4" Double Offset Centerline, Washers Included	B	5	5	\$16.55
521-730	Carrier Bracket Height Extension Bracket	B	5	5	\$12.95



521-725

## ChaseBracket™

### Copper-Plated

Item Number	Item Description	Pkg Type	Min Qty	Case Qty	Price
521-723	J-Hook w/ 5" Stainless Snap-Lock Band, 16-Ga.	BI	25	25	\$10.46
521-723BB	J-Hook Only 16-Ga.	B	25	25	\$10.13



521-723BB

## Commercial Alignment Bracket

### Copper-Plated

Item Number	Item Description	Pkg Type	Min Qty	Case Qty	Price
521-110	Positioning Bracket For 1/2" Stub Outs On 4" Or 8" Centers	B	25	25	\$11.17
521-111	Stabilizing Combo Bracket For 1/2" And 3/4" Vertical Runs In Walls 3-1/2" Or Wider	B	50	50	\$12.05
521-112	Mid-Span Multi-Purpose Bracket w/ 3/4" Notches On 6" Centerline	B	50	50	\$11.87
521-113	Mid-Span Multi-Purpose Bracket w/ 3/4" Notches On 8" Centerline	B	50	50	\$11.87



521-110

Supply

Drainage

Support

Specialties

Appendix

Supply

Drainage

Support

Specialties

Appendix



570-22



572-20



570-53



570-58

## PipeTitan™

### Universal Bracketing System

Item Number	Item Description	Pkg Type	Min Qty	Case Qty	Price
<b>STANDARD (GREEN)</b>					
570	Bracket Only	B	24	24	\$4.60
570-10	Kit: Bracket, 2 Straps, 1 Clamp	BI	24	24	\$8.66
570-20	Kit: Bracket, 2 Straps, 1 Clamp w/ 5" S/S Band	BI	24	24	\$10.46
570-22	Kit: Bracket, 2 Straps, 1 Clamp w/ 5" S/S Snap-Lock Band	BI	24	24	\$11.60
570-24	Kit: Bracket, 2 Straps, 1 Clamp w/ 7" S/S Snap-Lock Band	BI	24	24	\$12.46
<b>FLAME RETARDANT (RED)</b>					
572	Bracket Only	B	24	24	\$6.84
572-20	Kit: Fr Bracket, 2 Straps, 1 Clamp w/ 5" S/S Band	BI	24	24	\$13.69
572-22	Kit: Fr Bracket, 2 Straps 1 Clamp, w/ 5" S/S Snap-Lock Band	BI	24	24	\$14.96
572-24	Kit: Fr Bracket, 2 Straps 1 Clamp w/ 7" S/S Snap-Lock Band	BI	24	24	\$15.34
<b>CLAMPS, STRAPS, &amp; STAINLESS STEEL BANDS</b>					
570-53	Small Tube Strap w/ Screws	BI	50	1000	\$1.24
570-58	Large Pipe Clamp w/ Screws	BI	50	50	\$1.68
572-53	Fr Small Tube Strap w/ Screws	BI	50	250	\$1.48
574-72	5" Diameter Standard Stainless Steel Band	B	50	50	\$3.16
574-74	4" Diameter Snap-Lock Stainless Steel Band	B	50	50	\$3.97
574-75	5" Diameter Snap-Lock Stainless Steel Band	B	50	50	\$4.94
574-77	7" Diameter Snap-Lock Stainless Steel Band	B	50	50	\$5.63

## PowerBar™ Mini Strut

### Suspension Support Bracket; Use with 3/8" Threaded Rod

· Clamps 1/4" - 1" CTS tube & 1/8" - 1" Sch. 40 pipe

Item Number	Item Description	Pkg Type	Min Qty	Case Qty	Price
<b>LIGHT DUTY POWERBAR™ MINI STRUT (20-GA)</b>					
523-2MS	1 Bracket, 13-5/8"	B	50	50	\$2.76
523-2MS2	1 Bracket, 2 TouchDown Clamps	B	50	50	\$4.49
523-2MS3	1 Bracket, 3 TouchDown Clamps	B	50	50	\$5.02
523-2MS4	1 Bracket, 4 TouchDown Clamps	B	50	50	\$5.69
<b>HEAVY DUTY POWERBAR™ MINI STRUT (16-GA)</b>					
523-3MSL	Long Bracket Only, 26"	B	25	25	\$7.63
523-3MSS	Short Bracket Only, 15"	B	25	25	\$3.90
523-3MSS2	Short Bracket, 15" w/ 2 TouchDown Clamps	B	25	25	\$6.68
523-3MSS3	Short Bracket, 15" w/ 3 TouchDown Clamps	B	25	25	\$7.27
<b>TOUCHDOWN™ CLAMP</b>					
522-5500	100 Bases, 100 Bridges, 100 Base Inserts (Bulk)	B	100	100	\$0.64
522-5501	1 Bridge, 1 Clamp Base, 1 Base Insert (1 Set/Bag)	B	100	100	\$1.10
523F5500	Plenumsafe™ 100 Bases, 100 Bridges, 100 Base Inserts (Bulk)	B	100	100	\$2.62

## PowerBar™ Mini Strut (Cont)

### Suspension Support Bracket; Use with 3/8" Threaded Rod

Item Number	Item Description	Pkg Type	Min Qty	Case Qty	Price
<b>POWERBAR™ MINI STRUT CLAMPS (COPPER-PLATED)</b>					
523-3MS2C	1/2" CTS w/ #8 × 3/4" Screw	B	25	100	\$1.09
523-3MS3C	3/4" CTS w/ #8 × 3/4" Screw	B	25	100	\$1.12
523-3MS4C	1" CTS w/ 5/16-18 Bolt	B	10	50	\$1.46
523-3MS5C	1-1/4" CTS w/ 5/16-18 Bolt	B	10	50	\$1.71
523-3MS6C	1-1/2" CTS w/ 5/16-18 Bolt	B	10	50	\$1.99
523-3MS7C	2" CTS w/ 5/16-18 Bolt	B	10	50	\$2.26
<b>POWERBAR™ MINI STRUT CLAMPS (ZINC-PLATED)</b>					
523-3MS2G	1/2" IPS w/ #8 × 3/4" Screw	B	25	100	\$1.04
523-3MS3G	3/4" IPS w/ #8 × 3/4" Screw	B	25	100	\$1.07
523-3MS4G	1" IPS w/ 5/16-18 Bolt	B	10	50	\$1.40
523-3MS5G	1-1/4" IPS w/ 5/16-18 Bolt	B	10	50	\$1.62
523-3MS6G	1-1/2" IPS w/ 5/16-18 Bolt	B	10	10	\$1.90
523-3MS7G	2" IPS w/ 5/16-18 Bolt	B	10	10	\$2.16
523-3MS8G	3" IPS w/ 5/16-18 Bolt	B	10	10	\$2.69
523-3MS9G	4" IPS w/ 5/16-18 Bolt	B	10	10	\$3.15



523-3MS2C



523-3MS4G

## SaddleUp™

### DWV Saddle Clamp

Item Number	Item Description	Pkg Type	Min Qty	Case Qty	Price
<b>SADDLE-UP™ CLAMPS</b>					
523-1	SaddleUp™ Galvanized DWV Clamp	B	50	50	\$1.55
523-1B	Clamp w/ 5" Snap-Lock S/S Band	B	5	50	\$6.01
523-1C	Clamp w/ 4" Snap-Lock S/S Band	B	5	50	\$4.90
523-1D	Clamp w/ 3" Snap-Lock S/S Band	B	5	50	\$4.54
<b>BULK STAINLESS STEEL BANDS</b>					
574-72	5" Diameter Standard Stainless Steel Band	B	50	50	\$3.16
574-74	4" Diameter Snap-Lock Stainless Steel Band	B	50	50	\$3.97
574-75	5" Diameter Snap-Lock Stainless Steel Band	B	50	50	\$4.94
574-77	7" Diameter Snap-Lock Stainless Steel Band	B	50	50	\$5.63
574-710	10" Diameter Snap-Lock Stainless Steel Band	B	10	10	\$7.65
574-713	13" Diameter Snap-Lock Stainless Steel Band	B	10	10	\$10.33



523-1B

## TD+™ Universal Clamps

· Clamps 1/2" CTS through 2" IPS

Item Number	Item Description	Pkg Type	Min Qty	Case Qty	Price
<b>TD+™ FLAT BASE CLAMP</b>					
550-2111	TD+ Clamp Base, Bridge And Screws, 1/Bag	BI	50	50	\$3.57
550-2111PK3	50 Bases, 50 Bridges, 100 Screws (Contr Pack) Bulk	B	1	1	\$178.50
550-2112	TD+ Clamp Base, 2 Bridges And Screws	BI	5	25	\$4.53
550-2113	1 Base, 3 Bridges, 2 Screws	BI	25	25	\$5.47



550-2111

Supply

Drainage

Support

Specialties

Appendix



550-2121



550-3131



550F3111



550F3121



550F3131

### TD+™ Universal Clamps (Cont)

Item Number	Item Description	Pkg Type	Min Qty	Case Qty	Price
<b>TD+ STRUT BASE CLAMP</b>					
550-210	Bridge Only	B	25	250	\$1.28
550-2121	1 Base, 1 Bridge, 1/Bag	BI	50	50	\$4.14
550-2121PK3	50 Bases, 50 Bridges, (Contr Pack) Bulk	B	1	1	\$207.00
550-2122	1 Base, 2 Bridges	BI	1	25	\$5.02
<b>3/8" THREADED ROD</b>					
550-3131	1 Base, 1 Bridge, 1/Bag	BI	50	50	\$4.14
550-3131PK3	50 Bases, 50 Bridges, (Contr Pack) Bulk	BI	1	1	\$207.00
550-3132	1 Base, 2 Bridges	BI	25	25	\$5.02

### TD+™ Plenum-Rated Universal Clamps

Item Number	Item Description	Pkg Type	Min Qty	Case Qty	Price
<b>PIPE CLAMP</b>					
550F3111	TD+ Clamp Base, Bridge And Screws	BI	25	25	\$10.99
<b>STRUT CLAMP</b>					
550F3121	1 Base, 1 Bridge, 1/Bag	BI	10	10	\$11.22
550F3121PK3	50 Bases, 50 Bridges, (Contr Pack) Bulk	BI	1	1	\$561.00
<b>3/8" THREADED ROD</b>					
550F3131	1 Base, 1 Bridge, 1/Bag	BI	10	10	\$11.22
550F3131PK3	50 Bases, 50 Bridges, (Contr Pack) Bulk	BI	1	1	\$561.00

**Acoustical TD+™ Universal Clamps**

· Clamps 1/2" CTS through 2" IPS

Item Number	Item Description	Pkg Type	Min Qty	Case Qty	Price
<b>PIPE CLAMP</b>					
550-2111Q	TD+ Clamp, 1 Base, 1 Bridge, 2 Screws, 2 PipeDown™ Cushions	BI	5	50	\$5.41
550-2112Q	TD+ Clamp, 1 Base, 2 Bridges, 2 Screws, 4 PipeDown™ Cushions	BI	5	25	\$6.43
<b>STRUT CLAMP</b>					
550-2121Q	TD+ Clamp, 1 Base, 1 Bridge, 2 PipeDown™ Cushions	BI	1	25	\$6.29
550-2122Q	TD+ Clamp, 1 Base, 2 Bridges, 4 PipeDown™ Cushions	BI	1	25	\$7.26
<b>ACCESSORIES</b>					
550-214QPK2	PipeDown™ Acoustical Cushion, 10/Bag	CI	1	10	\$13.98
550-214QPK3	PipeDown™ Acoustical Cushion (Contr Pack), 50/Bag	BI	1	4	\$55.99



550-2111Q



550-2121Q



550-214QPK2

**Acoustical Isolation Accessories**

Item Number	Item Description	Pkg Type	Min Qty	Case Qty	Price
<b>FELT &amp; LINER</b>					
575-100Q	2-1/4" × 100' × 1/8" Self-Adhesive Felt (Roll)	B	1	12	\$86.12
575-101Q	3/4" W × 25' (Roll)	B	1	10	\$109.92
575-102Q	2" W × 25' Self-Adhesive (Roll)	B	1	10	\$273.83
<b>CUSHIONS</b>					
575-510Q	PipeDown™ 2" × 2" × 3/4" Bumperpad™	B	25	25	\$2.04
575-511Q	PipeDown™ 2" × 2" × 3/4" Bumperpad™ w/ Flat Plate	B	25	25	\$4.31
575-512Q	PipeDown™ 2" × 2" × 3/4" Bumperpad™ w/ Formed Plate	B	25	25	\$4.31



575-100Q



575-510Q

**Manifold Brackets**

**Plastic**

Item Number	Item Description	Pkg Type	Min Qty	Case Qty	Price
550-AMB	PEX Manifold Bracket w/ Components, 1 Pair/Bag	BI	10	10	\$31.05



550-AMB

Supply

Drainage

Support

Specialties

Appendix

**Roof Top Block**

Item Number	Item Description	Pkg Type	Min Qty	Case Qty	Price
<b>ROOF TOP BLOCK SUPPORT BRACKET</b>					
543-21	TakeOff™ Roof Top Support Block - Adjustable Bracket	B	8	8	\$19.00
<b>ACCESSORIES</b>					
543-21R	Roller Support Assembly Kit for 3/8" Thread Rod	BI	8	8	\$10.50



543-21



543-21R

Supply

Drainage

Support

Specialties

Appendix

# Overhead Brackets

**PipeEye™ Suspension Bracket**

**Beam Clamps & Connectors**

**Adjustable Swivel/Loop**

**Clevis Hangers**

**Split-Ring Hangers**

**Strut Clamps**

**Cushion Clamps**

**Saddle Shields**

**Sioux Chief  
Sammys**







## PipeEye™ Suspension Bracket

### Galvanized Steel

· Use with PipeEye™ insulators

#### Related Products

PipeEye™ Insulators p 489



521-557

Item Number	Item Description	Pkg Type	Min Qty	Case Qty	Price
521-557	Single Hole	B	25	25	\$1.67
521-558	Double Hole	B	25	25	\$1.85
521-559	Quadruple Hole	B	25	25	\$2.46

## Beam Clamp & Connector Products

### Accepts 3/8" Thread Rod

Item Number	Item Description	Pkg Type	Min Qty	Case Qty	Price
<b>TOP PLATE CONNECTOR</b>					
541-CB	Copper-Plated Steel (Bulk)	B	25	25	\$2.85
541-CPK2	Copper-Plated Steel, 1/Bag	CI	20	20	\$3.18
541-GB	Zinc-Plated Steel (Bulk)	B	25	25	\$2.26
541-GPK2	Zinc-Plated Steel, 1/Bag	CI	20	20	\$2.52
<b>TOP BEAM CLAMP</b>					
542-PK2	Ductile Iron, 1/Bag	CI	10	10	\$4.37



541-CB



542-PK2

## Adjustable Swivel/Loop

Item Number	Item Description	Pkg Type	Min Qty	Case Qty	Price
<b>GALVANIZED</b>					
514-G02	1/2" IPS	B	100	100	\$0.92
514-G03	3/4" IPS	B	100	100	\$0.96
514-G04	1" IPS	B	100	100	\$1.00
514-G05	1-1/4" IPS	B	100	100	\$1.08
514-G06	1-1/2" IPS	B	100	100	\$1.09
514-G07	2" IPS	B	100	100	\$1.19
<b>ACOUSTICAL</b>					
514-G02Q	1/2" CTS	B	50	50	\$3.82
514-G03Q	3/4" CTS	B	50	50	\$4.03
514-G04Q	1" CTS	B	25	25	\$4.23
514-G05Q	1-1/4" CTS	B	25	25	\$4.66
514-G06Q	1-1/2" CTS	B	25	25	\$5.21
514-G07Q	2" CTS	B	10	10	\$5.55



514-G02

Supply

Drainage

Support

Specialties

Appendix



515-2CPK2



515-2GPK2



516-2CPK2



516-2GPK2



516-2CB

### Clevis hanger

Item Number	Item Description	Pkg Type	Min Qty	Case Qty	Price
<b>COPPER-PLATED</b>					
515-2CPK2	1/2" CTS, 1/Bag	CI	10	10	\$2.68
515-3CPK2	3/4" CTS, 1/Bag	CI	10	10	\$2.72
515-4CPK2	1" CTS, 1/Bag	CI	10	10	\$2.77
515-5CPK2	1-1/4" CTS, 1/Bag	CI	10	10	\$3.01
515-6CPK2	1-1/2" CTS, 1/Bag	CI	10	10	\$3.20
515-7CPK2	2" CTS, 1/Bag	CI	10	10	\$3.68
<b>GALVANIZED</b>					
515-2GPK2	1/2" IPS, 1/Bag	CI	10	10	\$2.39
515-3GPK2	3/4" IPS, 1/Bag	CI	10	10	\$2.48
515-4GPK2	1" IPS, 1/Bag	CI	10	10	\$2.49
515-5GPK2	1-1/4" IPS, 1/Bag	CI	10	10	\$2.85
515-6GPK2	1-1/2" IPS, 1/Bag	CI	10	10	\$3.24
515-7GPK2	2" IPS, 1/Bag	CI	10	10	\$4.06
515-8GPK2	2-1/2" IPS, 1/Bag	CI	10	10	\$5.48
515-9GPK2	3" IPS, 1/Bag	CI	10	10	\$6.17
515-10GPK2	4" IPS, 1/Bag	CI	10	10	\$6.63

### Split Ring Hanger

Item Number	Item Description	Pkg Type	Min Qty	Case Qty	Price
<b>EPOXY-COATED IRON W/ CU COLOR (IMPORTED)</b>					
516-2CPK2	1/2" CTS, 1/Bag	CI	20	20	\$2.74
516-3CPK2	3/4" CTS, 1/Bag	CI	20	20	\$2.90
516-4CPK2	1" CTS, 1/Bag	CI	10	10	\$3.35
516-5CPK2	1-1/4" CTS, 1/Bag	CI	10	10	\$3.84
516-6CPK2	1-1/2" CTS, 1/Bag	CI	10	10	\$4.23
516-7CPK2	2" CTS, 1/Bag	CI	10	10	\$5.01
<b>GALVANIZED IRON (IMPORTED)</b>					
516-2GPK2	1/2" IPS, 1/Bag	CI	20	20	\$2.47
516-3GPK2	3/4" IPS, 1/Bag	CI	20	20	\$2.80
516-4GPK2	1" IPS, 1/Bag	CI	10	10	\$2.90
516-5GPK2	1-1/4" IPS, 1/Bag	CI	10	10	\$3.79
516-6GPK2	1-1/2" IPS, 1/Bag	CI	10	10	\$4.15
516-7GPK2	2" IPS, 1/Bag	CI	10	10	\$4.53
<b>COPPER-PLATED STEEL (DOMESTIC)</b>					
516-4CB	1" CTS	B	100	100	\$3.69
516-5CB	1-1/4" CTS	B	100	100	\$4.11
516-6CB	1-1/2" CTS	B	100	100	\$4.45
516-7CB	2" CTS	B	100	100	\$5.13
<b>GALVANIZED STEEL (DOMESTIC)</b>					
516-2GB	1/2" IPS	B	100	100	\$3.56

## Strut Clamps

Item Number	Item Description	Pkg Type	Min Qty	Case Qty	Price
<b>COPPER ZINC DICHROMATE</b>					
517-C02	1/2" CTS, 1/Bag	BI	100	100	\$1.37
517-C03	3/4" CTS, 1/Bag	BI	100	100	\$1.51
517-C04	1" CTS, 1/Bag	BI	100	100	\$1.64
517-C05	1-1/4" CTS, 1/Bag	BI	50	50	\$1.82
517-C06	1-1/2" CTS, 1/Bag	BI	50	50	\$2.07
517-C07	2" CTS, 1/Bag	BI	50	50	\$2.47
517-C08	2-1/2" CTS, 1/Bag	BI	50	50	\$3.24
517-C09	3" CTS, 1/Bag	BI	50	50	\$3.36
517-C10	4" CTS, 1/Bag	BI	25	25	\$4.94
<b>ZINC-PLATED</b>					
517-G02	1/2" IPS, 1/Bag	BI	100	100	\$1.08
517-G03	3/4" IPS, 1/Bag	BI	100	100	\$1.18
517-G04	1" IPS, 1/Bag	BI	100	100	\$1.25
517-G05	1-1/4" IPS, 1/Bag	BI	100	100	\$1.30
517-G06	1-1/2" IPS, 1/Bag	BI	50	50	\$1.95
517-G07	2" IPS, 1/Bag	BI	50	50	\$2.07
517-G08	2-1/2" IPS, 1/Bag	BI	50	50	\$2.30
517-G09	3" IPS, 1/Bag	BI	25	25	\$2.86
517-G10	4" IPS, 1/Bag	BI	25	25	\$3.37



517-C02



517-G02

## Copper Tube Cushion Clamps

Item Number	Item Description	Pkg Type	Min Qty	Case Qty	Price
<b>STEEL CLAMP WITH TPR CUSHION/ISOLATOR</b>					
517-I062PK2	1/2" CTS (.625 O.D.), 1/Bag	BI	25	25	\$4.90
517-I087PK2	3/4" CTS (.875 O.D.), 1/Bag	BI	25	25	\$5.14
517-I112PK2	1" CTS (1.125 O.D.), 1/Bag	BI	20	20	\$5.63
517-I137PK2	1-1/4" CTS (1.375 O.D.), 1/Bag	BI	20	20	\$6.38
517-I162PK2	1-1/2" CTS (1.625 O.D.), 1/Bag	BI	20	20	\$7.56
517-I212PK2	2" CTS (2.125 O.D.), 1/Bag	BI	10	10	\$10.51



517-I062PK2

Supply

Drainage

Support

Specialties

Appendix

## Sioux Chief Sammys - Thread Rod Anchors

### Accepts 3/8" Thread Rod

Item Number	Item Description	Pkg Type	Min Qty	Case Qty	Price
<b>WOOD APPLICATIONS</b>					
590-4411	1/4" x 2" Screw, Vertical, 25/Box	BI	1	5	\$45.48
590-4411-3	1/4" x 3" Screw, Vertical, 25/Box	BI	1	5	\$47.14
590-4421	1/4" x 2" Screw, Horizontal, 25/Box	BI	1	5	\$56.29
<b>CONCRETE APPLICATIONS</b>					
590-4412	1/4" x 1-3/4" Screw, Vertical, 25/Box	BI	1	5	\$52.51
<b>STEEL BEAM APPLICATIONS</b>					
590-4413	1/4" x 2" Screw, Vertical, 25/Box	BI	1	5	\$46.30
590-4423	1/4" x 1-1/4" Screw, Horizontal, w/ Nut, 25/Box	BI	1	5	\$68.23
<b>INSTALLATION TOOLS</b>					
590-44ND1	Nut Driver #14 For Vertical Anchors (Black), 1/Bag	BI	1	12	\$24.25
590-44ND2	Nut Driver #14SW For Horizontal Anchors (Red), 1/Bag	BI	1	12	\$24.25



Supply

Drainage

Support

Specialties

Appendix

# **Stud Guards & Safety Plates**

**Stud Guards**

**Stud Shoe**

**Shield Plate**





**Stud Guard**

**Self-Nailing**

Item Number	Item Description	Pkg Type	Min Qty	Case Qty	Price
530-163	1-1/2" x 3", 16-Ga	B	100	100	\$0.49
530-1635	3" x 5", 16-Ga	B	100	100	\$1.19
530-163PK	1-1/2" x 3", 16-Ga IBC	BI	100	100	\$0.74
530-166	1-1/2" x 6", 16-Ga	B	100	100	\$0.74
530-166PK	1-1/2" x 6", 16-Ga IBC	CI	100	100	\$0.99
530-166PK3	1-1/2" x 6", 16-Ga, (Contr Pack), 100/Box	BI	1	1	\$74.00
530-169	1-1/2" x 9, 16-Ga	B	50	50	\$1.42
536-35	3" x 5", 16-Ga w/ Offset Nail Spikes	B	100	100	\$1.19
536-36	3-1/2" x 6", 16-Ga	B	50	50	\$1.71
536-56E	5" x 6", 16-Ga w/ Offset Nail Spikes	B	50	50	\$3.44
536-58	5" x 8", 16-Ga w/ Nail Spikes And 6 Nail Holes	B	50	50	\$3.67
536-68E	6" x 8", 16-Ga w/ Offset Nail Spikes	B	50	50	\$8.21



530-163

**Stud Guard**

**Metal Studs**

Item Number	Item Description	Pkg Type	Min Qty	Case Qty	Price
530-6M	1-1/2" x 6", 16-Ga w/ Nail Holes	B	100	100	\$0.74



530-6M

**Stud Shoe**

Item Number	Item Description	Pkg Type	Min Qty	Case Qty	Price
533-1	Single, 16-Ga	B	25	25	\$5.25
533-2	Double, 16-Ga	B	25	25	\$8.36
533-3	Triple, 16-Ga	B	10	10	\$9.53



533-1

Supply

Drainage

Support

Specialties

Appendix

Supply

Drainage

Support

Specialties

Appendix



**Shield Plate**

Item Number	Item Description	Pkg Type	Min Qty	Case Qty	Price
536-09	1-1/2" x 9" w/ 8 Holes 16-Ga	B	50	50	\$1.30
536-12	1-1/2" x 12" w/ 8 Holes 16-Ga	B	50	50	\$1.65
536-18	1-1/2" x 18" w/ 16 Holes 16-Ga	B	50	50	\$2.51
536-612	6" x 12" w/ 16 Holes 16-Ga	B	25	25	\$5.65
536-616	6" x 16" w/ 2 Holes 16-Ga. Galvanized	B	25	25	\$7.62
536-85	5" x 8" w/ 6 Holes 16-Ga	BI	50	50	\$3.59
538-09	1-1/2" x 9" w/ 8 Holes 18-Ga	B	50	50	\$1.15
538-09PK	1-1/2" x 9" w/ 8 Holes 18-Ga	BI	50	50	\$1.65
538-12	1-1/2" x 12" w/ 8 Holes 18-Ga	B	50	50	\$1.38
538-18	1-1/2" x 18" w/ 16 Holes 18-Ga	B	50	50	\$2.15
539-18	3-1/2" x 18" w/ 16 Holes 16-Ga	B	25	25	\$5.02
539-518	5" x 18" w/ 16 Holes 16-Ga	B	25	25	\$7.86
539-6	3-1/2" x 6" w/ 6 Holes 16-Ga	B	50	50	\$1.80



# **Water Heater Accessories**

**Water Heater Stands**

**Expansion Tank Support Kits**





**Water Heater Stand**

Item Number	Item Description	Pkg Type	Min Qty	Case Qty	Price
598-010	21 × 21 × 18 Standard For 30-50-Gal Units	Bl	1	1	\$95.66
598-011	21 × 21 × 18 Fast Assembly For 30-50 Gal Units	Bl	1	1	\$95.66
598-012	24 × 24 × 18 Heavy Duty For 50-100 Gal Units	Bl	1	1	\$192.20



521-010

**Expansion Tank Support Kits**

Item Number	Item Description	Pkg Type	Min Qty	Case Qty	Price
<b>SADDLEUP™ EXPANSION TANK SUPPORT KIT</b>					
598-0210	10" Max Diameter Band, Bracket And Screws - Contractor Pack	B	10	10	\$8.68
598-0210PK1	Kit: 10" Max Diameter Band, Bracket And Screws, 1/Bag	Bl	1	25	\$11.43
598-0210PK2	Kit: 10" Max Diameter Band, Bracket And Screws, 2/Bag	Bl	1	25	\$20.11
598-0213	13" Max Diameter Band, Bracket And Screws - Contractor Pack	B	10	10	\$9.84
598-0213PK1	Kit: 13" Max Diameter Band, Bracket And Screws, 1/Bag	Bl	1	25	\$12.59
598-0213PK2	Kit: 13" Max Diameter Band, Bracket And Screws, 2/Bag	Bl	1	25	\$22.43
<b>TANKBRACKET™</b>					
598-022	2 pc. TANK Bracket - Leg/Foot/Ties, 1/Bag	Bl	10	10	\$24.00
598-023	3 pc. TANK Bracket - Leg/Foot/Arm/Extension Pc/Ties, 1/Bag	Bl	10	10	\$28.50



598-0210



598-022



598-023

Supply

Drainage

Support

Specialties

Appendix



# Specialties

**Tubular**

**Plumbing Specialties**

**Tubing & Hose**

**Tubing/Hose Fittings**

**Tools & Chemicals**

**»» Making it in America**



**Tubular**

**Plastic Tubular**

**Metal Tubular**

**Basket Strainers  
& Sink Drains**

**Bath Waste Drains**

# Tubular

## Plastic Tubular

White and black polypropylene tubular products designed in accordance with ASTM F409 Standard Specification for Thermoplastic Accessible and Replaceable Plastic Tube and Tubular Fittings.

## Metal Tubular

Brass and chrome-plated brass tubular products designed in accordance with ASME A112.18.2/CSA B125.2 Standard for Plumbing Waste Fittings.

## Basket Strainers & Sink Drains

A wide selection of basket strainer options for kitchen sinks, including KiwkFit™, Specification™ and BigBoy™ designs. Lavatory sink drains and drains for bar sinks also available.

## Bath Waste Drains

Brass and plastic waste/overflow fittings for bathtubs in trip-lever Ezy Touch® and Twist-N-Close™ designs. Chrome, satin nickel, and other finish options available.



# Plastic Tubular

**P-Traps**

**S-Traps**

**End Outlets**

**Center Outlets**

**Disposer Wastes**

**Sink Tailpieces  
& Extensions**

**Dishwasher Tailpieces**

**Waste Arms**

**Flexible Fittings**

**Accessories**





**230-0206101**  
Page 563



**230-0226301**  
Page 563



**230-0908101**  
Page 564



**230-1005101**  
Page 564



**230-1506101**  
Page 564



**230-181616101**  
Page 565



**230-270616101**  
Page 566



**230-290616201**  
Page 566



**230-320616101**  
Page 566



**230-40060450**  
Page 567



**230-450506132**  
Page 568



**230-58060825**  
Page 568



**230-600607101**  
Page 569



**230-8006125**  
Page 570



**230-8506101**  
Page 570



**231-1506101**  
Page 571



**988-5000**  
Page 572

**P-Traps**

**Standard**

Item Number	Item Description	Pkg Type	Min Qty	Case Qty	Price
<b>LESS ADAPTER</b>					
230-0105101	1-1/4" w/ Poly Washer, White, 1/Bag	BI	25	25	\$2.18
230-0105201	1-1/4" w/ Soft Washer, White, 1/Bag	BI	25	25	\$2.18
230-0106101	1-1/2" w/ Poly Washer, White, 1/Bag	BI	50	50	\$2.20
230-0106201	1-1/2" w/ Soft Washer, White, 1/Bag	BI	50	50	\$2.20
230-0115101	1-1/4" w/ Poly Washer, Black, 1/Bag	BI	25	25	\$2.18
230-0115201	1-1/4" w/ Soft Washer, Black, 1/Bag	BI	25	25	\$2.18
<b>WITH THREADED ADAPTER</b>					
230-0206101	1-1/2" w/ PVC Trap Adapter & Poly Washers, White, 1/Bag	BI	50	50	\$2.22
230-0206201	1-1/2" w/ PVC Trap Adapter & Soft Washers, White, 1/Bag	BI	50	50	\$2.22
230-0316101	1-1/2" w/ ABS Trap Adapter & Poly Washers, Black, 1/Bag	BI	50	50	\$2.22
230-0316201	1-1/2" w/ ABS Trap Adapter & Soft Washers, Black, 1/Bag	BI	50	50	\$2.22
<b>WITH THREADED ADAPTER &amp; DEEP ESCUTCHEON</b>					
230-0226301	1-1/2" PVC Trap Adapter, Deep Escutcheon & Poly Washers, Chromed ABS, 1/Bag	BI	25	25	\$16.32
<b>WITH SOLVENT WELD ADAPTER</b>					
230-0406101	1-1/2" w/ PVC Solvent Weld Trap Adapter, PVC Wall Bend & Poly Washers, White, 1/Bag	BI	50	50	\$3.90
230-0406201	1-1/2" w/ PVC Solvent Weld Trap Adapter, PVC Wall Bend & Soft Washers, White, 1/Bag	BI	50	50	\$3.45
230-0516150	1-1/2" w/ ABS Solvent Weld Trap Adapter, ABS Wall Bend & Poly Washers, Black 1/Bag	BI	50	50	\$3.90



230-0105101



230-0206101



230-0226301



230-0406101

**P-Traps**

**Reversible**

Item Number	Item Description	Pkg Type	Min Qty	Case Qty	Price
<b>WITH THREADED ADAPTER</b>					
230-0706101	1-1/2" w/ PVC Trap Adapter & Poly Washers, White, 1/Bag	BI	50	50	\$2.58
230-0706201	1-1/2" w/ PVC Trap Adapter & Soft Washers, White, 1/Bag	BI	50	50	\$2.58
230-0716101	1-1/2" w/ ABS Trap Adapter & Poly Washers, Black, 1/Bag	BI	50	50	\$2.58
230-0716201	1-1/2" w/ ABS Trap Adapter & Soft Washers, Black, 1/Bag	BI	50	50	\$2.58
230-0806101	1-1/2" w/ ABS Trap Adapter & Poly Washers, White, 1/Bag	BI	50	50	\$2.97
230-0806201	1-1/2" w/ ABS Trap Adapter & Soft Washers, White, 1/Bag	BI	50	50	\$2.97
<b>WITH THREADED ADAPTER &amp; DEEP ESCUTCHEON</b>					
230-0706401	1-1/2" w/ PVC Trap Adapter, Soft Washer & Deep Poly Escutcheon White, 1/Bag	BI	50	50	\$3.66



230-0706101



230-0706401

Supply

Drainage

Support

Specialties

Appendix

Supply

Drainage

Support

Specialties

Appendix



230-0908101



230-1005101



230-1106101



230-1106301



230-1505101



230-170607101

**P-Traps**

**Repair**

Item Number	Item Description	Pkg Type	Min Qty	Case Qty	Price
230-0908101	1-1/2" w/ Poly Washers, White, 1/Bag	BI	12	12	\$10.57
230-0918101	1-1/2" w/ Poly Washers, Black, 1/Bag	BI	12	12	\$10.57

**S-Traps**

Item Number	Item Description	Pkg Type	Min Qty	Case Qty	Price
<b>LESS ADAPTER</b>					
230-1005101	1-1/4" w/ Poly Washers, White, 1/Bag	BI	10	10	\$7.59
230-1005201	1-1/4" w/ Soft Washers, White, 1/Bag	BI	10	10	\$7.97
230-1015101	1-1/4" w/ Poly Washers, Black, 1/Bag	BI	10	10	\$7.59
230-106101	1-1/2" w/ Poly Washers, White, 1/Bag	BI	10	10	\$8.00
<b>WITH THREADED ADAPTER</b>					
230-1106101	1-1/2" w/ PVC Trap Adapter & Poly Washers, White, 1/Bag	BI	10	10	\$8.61
230-1106201	1-1/2" w/ PVC Trap Adapter & Soft Washers, White, 1/Bag	BI	10	10	\$8.78
230-1116101	1-1/2" w/ ABS Trap Adapter & Poly Washers, Black, 1/Bag	BI	10	10	\$8.94
<b>WITH THREADED ADAPTER &amp; DEEP ESCUTCHEON</b>					
230-1106301	1-1/2" w/ PVC Trap Adapter, Deep Poly Escutcheon & Poly Washers, White, 1/Bag	BI	10	10	\$9.61

**Trap Accessories**

Item Number	Item Description	Pkg Type	Min Qty	Case Qty	Price
<b>J-BEND</b>					
230-1505101	1-1/4" w/ Poly Washers, White, 1/Bag	BI	12	12	\$2.73
230-1506101	1-1/2" w/ Poly Washers, White, 1/Bag	BI	25	25	\$2.73
230-1516101	1-1/2" w/ Poly Washers, Black, 1/Bag	BI	25	25	\$2.73
<b>SINK TRAP J-BEND</b>					
230-1606101	1-1/2" w/ Poly Washers, White, 1/Bag	BI	12	12	\$3.56
230-1616101	1-1/2" w/ Poly Washers, Black, 1/Bag	BI	12	12	\$3.56
<b>WALL BEND</b>					
230-170507101	1-1/4" x 7", White, 1/Bag	BI	25	25	\$1.88
230-170607101	1-1/2" x 7", White, 1/Bag	BI	25	25	\$1.88

End Outlets

Telescoping

Item Number	Item Description	Pkg Type	Min Qty	Case Qty	Price
<b>ALL-PURPOSE</b>					
230-170616101	1-1/2" x 16" w/ Poly Washers, White, 1/Bag	Bl	25	25	\$9.12
230-170616201	1-1/2" x 16" w/ Soft Washers, White, 1/Bag	Bl	25	25	\$9.34
230-171616101	1-1/2" x 16" w/ Poly Washers, Black, 1/Bag	Bl	25	25	\$9.57
230-180616101	1-1/2" x 16" w/ 1/2" Dishwasher Branch & Poly Washers, White, 1/Bag	Bl	25	25	\$10.99
230-180616201	1-1/2" x 16" w/ 1/2" Dishwasher Branch & Soft Washers, White, 1/Bag	Bl	25	25	\$11.27
230-181616101	1-1/2" x 16" w/ 1/2" Dishwasher Branch & Poly Washers, Black, 1/Bag	Bl	25	25	\$11.01
230-190616101	1-1/2" x 16" w/ 3/4" Dishwasher Branch & Poly Washers, White, 1/Bag	Bl	25	25	\$10.99
230-190616201	1-1/2" x 16" w/ 3/4" Dishwasher Branch & Soft Washers, White, 1/Bag	Bl	25	25	\$11.27
230-191616101	1-1/2" x 16" w/ 3/4" Dishwasher Branch & Poly Washers, Black, 1/Bag	Bl	25	25	\$11.01
<b>SLIP JOINT</b>					
230-200616101	1-1/2" x 16" w/ Poly Washers, White, 1/Bag	Bl	25	25	\$7.72
230-200616201	1-1/2" x 16" w/ Soft Washers, White, 1/Bag	Bl	25	25	\$7.92
230-201616101	1-1/2" x 16" w/ Poly Washers, Black, 1/Bag	Bl	25	25	\$7.92
230-210616101	1-1/2" x 16" w/ 1/2" Dishwasher Branch & Poly Washers, White, 1/Bag	Bl	25	25	\$8.31
230-210616201	1-1/2" x 16" w/ 1/2" Dishwasher Branch & Soft Washers, White, 1/Bag	Bl	25	25	\$8.56
230-220616101	1-1/2" x 16" w/ 3/4" Dishwasher Branch & Poly Washers, White, 1/Bag	Bl	10	10	\$8.31
230-220616201	1-1/2" x 16" w/ 3/4" Dishwasher Branch & Soft Washers, White, 1/Bag	Bl	25	25	\$8.56
<b>DIRECT CONNECT</b>					
230-230616101	1-1/2" x 16" w/ Poly Washers, White, 1/Bag	Bl	25	25	\$7.72
230-230616201	1-1/2" x 16" w/ Soft Washers, White, 1/Bag	Bl	25	25	\$7.92
230-231616101	1-1/2" x 16" w/ Poly Washers, Black, 1/Bag	Bl	25	25	\$7.92
230-240616101	1-1/2" x 16" w/ 1/2" Dishwasher Branch & Poly Washers, White, 1/Bag	Bl	25	25	\$8.57
230-240616201	1-1/2" x 16" w/ 1/2" Dishwasher Branch & Soft Washers, White, 1/Bag	Bl	25	25	\$8.77
230-241616101	1-1/2" x 16" w/ 1/2" Dishwasher Branch & Poly Washers, Black, 1/Bag	Bl	25	25	\$8.77
230-250616101	1-1/2" x 16" w/ 3/4" Dishwasher Branch & Poly Washers, White, 1/Bag	Bl	25	25	\$8.57
230-250616201	1-1/2" x 16" w/ 3/4" Dishwasher Branch & Soft Washers, White, 1/Bag	Bl	25	25	\$8.77
230-251616101	1-1/2" x 16" w/ 3/4" Dishwasher Branch & Poly Washers, Black, 1/Bag	Bl	25	25	\$8.77



230-170616101



230-181616101



230-200616101



230-240616201

End Outlets

Non-Telescoping

Item Number	Item Description	Pkg Type	Min Qty	Case Qty	Price
<b>ALL-PURPOSE</b>					
230-2606101	1-1/2" x 16" w/ Poly Washers, White, 1/Bag	Bl	20	20	\$5.63
230-2606201	1-1/2" x 16" w/ Soft Washers, White, 1/Bag	Bl	20	20	\$5.63
230-261616101	1-1/2" x 16" w/ Poly Washers, Black, 1/Bag	Bl	25	25	\$5.78



230-2606101

Supply

Drainage

Support

Specialties

Appendix

### End Outlets (Cont)

#### Non-Telescoping



230-270616101



230-280616101

Item Number	Item Description	Pkg Type	Min Qty	Case Qty	Price
<b>SLIP JOINT</b>					
230-270616101	1-1/2" x 16" w/ Poly Washers, White, 1/Bag	BI	25	25	\$5.52
230-270616201	1-1/2" x 16" w/ Soft Washers, White, 1/Bag	BI	25	25	\$5.66
230-270621101	1-1/2" x 21" w/ Poly Washers, White, 1/Bag	BI	25	25	\$15.18
230-270625101	1-1/2" x 25" w/ Poly Washers, White, 1/Bag	BI	25	25	\$16.77
230-271616101	1-1/2" x 16" w/ Poly Washers, Black, 1/Bag	BI	25	25	\$5.66
230-271616201	1-1/2" x 16" w/ Soft Washers, Black, 1/Bag	BI	25	25	\$5.66
230-271621101	1-1/2" x 21" w/ Poly Washers, Black, 1/Bag	BI	25	25	\$15.18
230-271625101	1-1/2" x 25" w/ Poly Washers, Black, 1/Bag	BI	25	25	\$16.77
<b>DIRECT CONNECT</b>					
230-280616101	1-1/2" x 16" w/ Poly Washers, White, 1/Bag	BI	25	25	\$5.41
230-280616201	1-1/2" x 16" w/ Soft Washers, White, 1/Bag	BI	25	25	\$5.53
230-281616101	1-1/2" x 16" w/ Poly Washers, Black, 1/Bag	BI	25	25	\$5.53

### Center Outlets



230-2906101



230-300616101



230-310616101

Item Number	Item Description	Pkg Type	Min Qty	Case Qty	Price
<b>ALL-PURPOSE</b>					
230-2906101	1-1/2" x 16" w/ Poly Washers, White, 1/Bag	BI	10	10	\$7.30
230-290616201	1-1/2" x 16" w/ Soft Washers, White, 1/Bag	BI	25	25	\$7.48
230-291616101	1-1/2" x 16" w/ Poly Washers, Black, 1/Bag	BI	25	25	\$7.48
<b>SLIP JOINT</b>					
230-300616101	1-1/2" x 16" w/ Poly Washers, White, 1/Bag	BI	25	25	\$6.76
230-300616201	1-1/2" x 16" w/ Soft Washers, White, 1/Bag	BI	25	25	\$6.94
230-300621101	1-1/2" x 21" w/ Poly Washers, White, 1/Bag	BI	25	25	\$8.85
230-300625101	1-1/2" x 25" w/ Poly Washers, White, 1/Bag	BI	25	25	\$11.93
230-301616101	1-1/2" x 16" w/ Poly Washers, Black, 1/Bag	BI	25	25	\$6.94
230-301621101	1-1/2" x 21" w/ Poly Washers, Black, 1/Bag	BI	25	25	\$8.85
230-301625101	1-1/2" x 25" w/ Poly Washers, Black, 1/Bag	BI	25	25	\$11.93
<b>DIRECT CONNECT</b>					
230-310616101	1-1/2" x 16" w/ Poly Washers, White, 1/Bag	BI	25	25	\$6.76
230-310616201	1-1/2" x 16" w/ Soft Washers, White, 1/Bag	BI	25	25	\$6.94
230-311616101	1-1/2" x 16" w/ Poly Washers, Black, 1/Bag	BI	25	25	\$6.94

### Disposer Waste



230-320616101

Item Number	Item Description	Pkg Type	Min Qty	Case Qty	Price
<b>DIRECT CONNECT - TELESCOPING</b>					
230-320616101	1-1/2" x 16" w/ Poly Washers & ISE® Gasket, White, 1/Bag	BI	25	25	\$6.55
230-320616201	1-1/2" x 16" w/ Soft Washers & ISE® Gasket, White, 1/Bag	BI	25	25	\$6.88
230-321616101	1-1/2" x 16" w/ Poly Washers & ISE® Gasket, Black, 1/Bag	BI	25	25	\$6.88

Supply

Drainage

Support

Specialties

Appendix

**Disposer Waste (Cont)**

Item Number	Item Description	Pkg Type	Min Qty	Case Qty	Price
<b>DIRECT CONNECT - NON-TELESCOPING</b>					
230-330616101	1-1/2" x 16" w/ Poly Washers & ISE® Gasket, White, 1/Bag	BI	25	25	\$5.51
230-330616201	1-1/2" x 16" w/ Soft Washers & ISE® Gasket, White, 1/Bag	BI	25	25	\$5.97
230-331616101	1-1/2" x 16" w/ Poly Washers & ISE® Gasket, Black, 1/Bag	BI	25	25	\$5.97



**Sink Tailpieces**

Item Number	Item Description	Pkg Type	Min Qty	Case Qty	Price
<b>FLANGED</b>					
230-40060125	1-1/2" x 1-1/4", White	BI	25	25	\$0.94
230-40060450	1-1/2" x 4", White	BI	50	50	\$1.26
230-40060650	1-1/2" x 6", White	BI	50	50	\$1.29
230-40060825	1-1/2" x 8", White	BI	25	25	\$1.29
230-40061225	1-1/2" x 12", White	BI	25	25	\$1.85
230-40160450	1-1/2" x 4", Black	BI	50	50	\$0.94
230-40160650	1-1/2" x 6", Black	BI	50	50	\$1.44
230-40160825	1-1/2" x 8", Black	BI	25	25	\$1.44
230-40161225	1-1/2" x 12", Black	BI	25	25	\$1.85
<b>DOUBLE FLANGED</b>					
230-41061625	1-1/2" x 16", White	BI	25	25	\$2.25
230-41161625	1-1/2" x 16", Black	BI	25	25	\$2.25



**Sink Tailpiece/Extension**

Item Number	Item Description	Pkg Type	Min Qty	Case Qty	Price
<b>FLANGE x SLIP JOINT</b>					
230-44061625	1-1/2" x 16" w/ Soft Washer, White, 1/Bag	BI	25	25	\$2.72



Supply

Drainage

Support

Specialties

Appendix

**Extensions**

Item Number	Item Description	Pkg Type	Min Qty	Case Qty	Price
<b>SLIP EXTENSION</b>					
230-450506132	1-1/4" x 6" w/ Poly Washer, White, 1/Bag	BI	32	32	\$2.53
230-450506232	1-1/4" x 6" w/ Soft Washer, White, 1/Bag	BI	32	32	\$2.58
230-450508125	1-1/4" x 8" w/ Poly Washer, White, 1/Bag	BI	25	25	\$2.93
230-450508225	1-1/4" x 8" w/ Soft Washer, White, 1/Bag	BI	25	25	\$3.00
230-450512116	1-1/4" x 12" w/ Poly Washer, White, 1/Bag	BI	16	16	\$3.54
230-450512216	1-1/4" x 12" w/ Soft Washer, White, 1/Bag	BI	16	16	\$3.63
230-450606132	1-1/2" x 6" w/ Poly Washer, White, 1/Bag	BI	32	32	\$2.09
230-450606232	1-1/2" x 6" w/ Soft Washer, White, 1/Bag	BI	32	32	\$2.14
230-450608116	1-1/2" x 8" w/ Poly Washer, White, 1/Bag	BI	16	16	\$2.25
230-450608216	1-1/2" x 8" w/ Soft Washer, White, 1/Bag	BI	16	16	\$2.31
230-450612116	1-1/2" x 12" w/ Poly Washer, White, 1/Bag	BI	16	16	\$2.47
230-450612216	1-1/2" x 12" w/ Soft Washer, White, 1/Bag	BI	16	16	\$2.53
230-451506132	1-1/4" x 6" w/ Poly Washer, Black, 1/Bag	BI	32	32	\$2.58
230-451606132	1-1/2" x 6" w/ Poly Washer, Black, 1/Bag	BI	32	32	\$2.18
230-451608116	1-1/2" x 8" w/ Poly Washer, Black, 1/Bag	BI	16	16	\$2.39
230-451608216	1-1/2" x 8" w/ Soft Washer, Black, 1/Bag	BI	16	16	\$2.45
230-451612116	1-1/2" x 12" w/ Poly Washer, Black, 1/Bag	BI	16	16	\$2.64
<b>DOUBLE SLIP EXTENSION</b>					
230-460516125	1-1/4" x 16" w/ Poly Washers, White, 1/Bag	BI	25	25	\$4.32
230-460516225	1-1/4" x 16" w/ Soft Washers, White, 1/Bag	BI	25	25	\$4.32
230-460616125	1-1/2" x 16" w/ Poly Washers, White, 1/Bag	BI	25	25	\$2.81
230-460616225	1-1/2" x 16" w/ Soft Washers, White, 1/Bag	BI	25	25	\$3.27
230-461516125	1-1/4" x 16" w/ Poly Washers, Black, 1/Bag	BI	25	25	\$4.32
230-461616125	1-1/2" x 16" w/ Poly Washers, Black, 1/Bag	BI	25	25	\$3.31
230-461616225	1-1/2" x 16" w/ Soft Washers, Black, 1/Bag	BI	25	25	\$3.36
<b>SOLVENT WELD EXTENSION</b>					
230-47050650	1-1/4" x 6", PVC	BI	50	50	\$2.47
230-47050825	1-1/4" x 8", PVC	BI	25	25	\$2.54
230-47051225	1-1/4" x 12", PVC	BI	25	25	\$2.76
230-47060825	1-1/2" x 8", PVC	BI	25	25	\$3.39
230-47061225	1-1/2" x 12", PVC	BI	25	25	\$3.40
230-47150850	1-1/4" x 8", ABS	BI	50	50	\$2.62
230-47160625	1-1/2" x 6", ABS	BI	25	25	\$3.46
230-47161225	1-1/2" x 12", ABS	BI	25	25	\$3.48
<b>DOUBLE SOLVENT WELD EXTENSION</b>					
230-48061625	1-1/2" x 16", PVC	BI	25	25	\$4.90

**Dishwasher Tailpieces**

Item Number	Item Description	Pkg Type	Min Qty	Case Qty	Price
<b>ALL-PURPOSE</b>					
230-57060825	1-1/2" x 8" x 1/2" Branch w/ Poly Washers, White, 1/Bag	BI	25	25	\$5.08
230-58060825	1-1/2" x 8" x 3/4" Branch w/ Poly Washers, White, 1/Bag	BI	25	25	\$5.08

Supply

Drainage

Support

Specialties

Appendix



230-450506132



230-460516125



230-47050650



230-48061625



230-57060825



**Dishwasher Tailpieces (Cont)**

Item Number	Item Description	Pkg Type	Min Qty	Case Qty	Price
<b>SLIP JOINT</b>					
230-530608225	1-1/2" x 8" x 1/2" Branch w/ Soft Washer, White, 1/Bag	Bl	25	25	\$2.71
230-53060825	1-1/2" x 8" x 1/2" Branch w/ Poly Washer, White, 1/Bag	Bl	25	25	\$2.60
230-53160825	1-1/2" x 8" x 1/2" Branch w/ Poly Washer, Black, 1/Bag	Bl	25	25	\$3.17
230-550608225	1-1/2" x 8" x 3/4" Branch w/ Soft Washer, White, 1/Bag	Bl	25	25	\$2.71
230-55060825	1-1/2" x 8" x 3/4" Branch w/ Poly Washer, White, 1/Bag	Bl	25	25	\$2.60
230-55160825	1-1/2" x 8" x 3/4" Branch w/ Poly Washer, Black, 1/Bag	Bl	25	25	\$3.17
<b>DIRECT CONNECT</b>					
230-54060825	1-1/2" x 8" x 1/2" Branch w/ Poly Washer, White, 1/Bag	Bl	25	25	\$2.67
230-54160825	1-1/2" x 8" x 1/2" Branch w/ Poly Washer, Black, 1/Bag	Bl	25	25	\$3.17
230-56060825	1-1/2" x 8" x 3/4" Branch w/ Poly Washer, White, 1/Bag	Bl	25	25	\$2.43
230-56160825	1-1/2" x 8" x 3/4" Branch w/ Poly Washer, Black, 1/Bag	Bl	25	25	\$3.17



230-53060825



230-54060825

**Waste Arms**

Item Number	Item Description	Pkg Type	Min Qty	Case Qty	Price
<b>SLIP JOINT</b>					
230-600607101	1-1/2" x 7" w/ Poly Washer, White, 1/Bag	Bl	25	25	\$3.08
230-600609125	1-1/2" x 9-1/2" w/ Poly Washer, White, 1/Bag	Bl	25	25	\$3.76
230-600611125	1-1/2" x 11-1/2" w/ Poly Washer, White, 1/Bag	Bl	25	25	\$4.57
230-600615125	1-1/2" x 15" w/ Poly Washer, White, 1/Bag	Bl	25	25	\$5.92
230-600624125	1-1/2" x 24" w/ Poly Washer, White, 1/Bag	Bl	25	25	\$7.20
230-60160725	1-1/2" x 7" w/ Poly Washer, Black, 1/Bag	Bl	25	25	\$3.15
230-60160925	1-1/2" x 9-1/2" w/ Poly Washer, Black, 1/Bag	Bl	25	25	\$3.84
230-601611125	1-1/2" x 11-1/2" w/ Poly Washer, Black, 1/Bag	Bl	25	25	\$4.71
230-601615125	1-1/2" x 15" w/ Poly Washer, Black, 1/Bag	Bl	25	25	\$6.07
<b>DIRECT CONNECT</b>					
230-61060725	1-1/2" x 7" w/ Poly Washer, White, 1/Bag	Bl	25	25	\$3.08
230-61060925	1-1/2" x 9-1/2" w/ Poly Washer, White, 1/Bag	Bl	25	25	\$3.76
230-61061225	1-1/2" x 11-1/2" w/ Poly Washer, White, 1/Bag	Bl	25	25	\$4.57
230-61061525	1-1/2" x 15" w/ Poly Washer, White, 1/Bag	Bl	25	25	\$5.92
230-61160725	1-1/2" x 7" w/ Poly Washer, Black, 1/Bag	Bl	25	25	\$3.15
230-61160925	1-1/2" x 9-1/2" w/ Poly Washer, Black, 1/Bag	Bl	25	25	\$3.84
230-61161125	1-1/2" x 11-1/2" w/ Poly Washer, Black, 1/Bag	Bl	25	25	\$4.71
230-61161525	1-1/2" x 15" w/ Poly Washer, Black, 1/Bag	Bl	25	25	\$6.07



230-600607101



230-61060725

Supply

Drainage

Support

Specialties

Appendix

**Tubular Fittings**

Item Number	Item Description	Pkg Type	Min Qty	Case Qty	Price
<b>COUPLINGS</b>					
230-8006125	1-1/2" w/ Poly Washers, White, 1/Bag	BI	25	25	\$3.42
230-8016125	1-1/2" w/ Poly Washers, Black, 1/Bag	BI	25	25	\$3.51
<b>ELBOWS</b>					
230-8206125	1-1/2" 90 Degree Elbow w/ Poly Washers, White, 1/Bag	BI	25	25	\$3.37
230-8216125	1-1/2" 90 Degree Elbow w/ Poly Washers, Black, 1/Bag	BI	25	25	\$3.37
230-8406101	1-1/2" 45 Degree Elbow w/ Poly Washers, White, 1/Bag	BI	25	25	\$3.83
<b>TEE SLIP JOINT</b>					
230-8506101	1-1/2" w/ Poly Washers, White, 1/Bag	BI	25	25	\$3.29
230-8516101	1-1/2" w/ Poly Washers, Black, 1/Bag	BI	25	25	\$3.29
<b>TEE - CENTER OUTLET SLIP JOINT</b>					
230-860625	1-1/2" w/ Poly Washers, White, 1/Bag	BI	25	25	\$2.58
230-861625	1-1/2" w/ Poly Washers, Black, 1/Bag	BI	25	25	\$2.58
<b>TEE - END OUTLET SLIP JOINT</b>					
230-8706125	1-1/2" w/ Poly Washers, White, 1/Bag	BI	25	25	\$3.88
230-8716125	1-1/2" w/ Poly Washers, Black, 1/Bag	BI	25	25	\$4.32
<b>TEE - END OUTLET DIRECT CONNECT</b>					
230-8806125	1-1/2" w/ Poly Washers, White, 1/Bag	BI	25	25	\$3.88
230-8816125	1-1/2" w/ Poly Washers, Black, 1/Bag	BI	25	25	\$4.32
<b>DOUBLE OFFSET</b>					
230-9006101	1-1/2" w/ Poly Washers, White, 1/Bag	BI	25	25	\$8.47
<b>THREADED TRAP ADAPTER</b>					
230-9506101	PVC 1-1/2" Sch. 40 Hub w/ Nut & Poly Washer, White, 1/Bag	BI	25	25	\$1.74
230-9506GT	PVC 1-1/2 Hub Trap Adapter w/ GripTip Test Nut	B	25	25	\$1.73
230-9506SGT	PVC 1-1/2 Spigot Trap Adapter w/ GripTip Test Nut	B	25	25	\$1.98
230-9516101	ABS 1-1/2" Sch. 40 Hub w/ Nut & Poly Washer, Black, 1/Bag	BI	25	25	\$2.21
988-6GT	1-1/2" Trap Adapter Nut w/ GripTip	B	25	25	\$0.88



230-8006125



230-8206125



230-8506101



230-860625



230-9006101



230-9506GT

Supply

Drainage

Support

Specialties

Appendix

**Flexible Fittings**

Item Number	Item Description	Pkg Type	Min Qty	Case Qty	Price
<b>J-BEND</b>					
231-1506101	1-1/2" Or 1-1/4" w/ Poly Washers, White, 1/Bag	Bl	25	25	\$10.61
<b>FLANGED TAILPIECE</b>					
231-4006101	1-1/2", White, 1/Bag	Bl	15	15	\$6.71
<b>SLIP EXTENSION</b>					
231-4505101	1-1/4" w/ Poly Washer, White, 1/Bag	Bl	15	15	\$9.45
231-4506101	1-1/2" w/ Poly Washer, White, 1/Bag	Bl	15	15	\$9.45
<b>COUPLING</b>					
231-4606101	1-1/2" w/ Poly Washers, White, 1/Bag	Bl	25	25	\$10.61



231-1506101



231-4006101



231-4606101

Supply

Drainage

Support

Specialties

Appendix

**Plastic Tubular Accessories**

Item Number	Item Description	Pkg Type	Min Qty	Case Qty	Price
<b>SLIP NUTS</b>					
988-5000	1-1/4" , White	B	100	1000	\$0.31
988-5100	1-1/4" , Black	B	100	1000	\$0.36
988-6	1-1/2" , White	B	100	1000	\$0.31
988-6100	1-1/2" , Black	B	100	1000	\$0.36
<b>FLANGED TAILPIECE WASHERS</b>					
991-6	1-1/2" Polyethylene	B	100	1000	\$0.17
991-6S	1-1/2" Red, Soft TPV	B	100	1000	\$0.29
<b>BEVELED SLIP JOINT WASHERS</b>					
996-500	1-1/4" Polyethylene	B	100	1000	\$0.13
996-5S	1-1/4" Red, Soft TPV	B	100	1000	\$0.23
996-6	1-1/2" Polyethylene	B	100	1000	\$0.17
996-6S	1-1/2" Red, Soft TPV	B	100	1000	\$0.20
<b>REDUCING WASHERS</b>					
996-8	1-1/2" × 1-1/4" Polyethylene	B	100	1000	\$0.13
996-8S	1-1/2" × 1-1/4" Red, Soft TPV	B	100	1000	\$0.23
<b>DISPOSAL WASHER</b>					
290-20180	Replacement In-Sink-Erator Disposal Elbow Gasket Only	B	5	25	\$0.93
<b>TUBULAR TEST NUT</b>					
988-6GT	1-1/2" Trap Adapter Nut w/ GripTip	B	25	25	\$0.88
<b>TRAP ADAPTER TEST PLUG</b>					
234-QP	1-1/2" Trap Adapter Test Plug	B	25	100	\$1.09
234-QP2	1-1/4" Trap Adapter Test Plug	B	25	100	\$1.09

Supply

Drainage

Support

Specialties

Appendix



988-5000



991-6



996-500



996-8S



290-20180



988-6GT

# Metal Tubular

**P-Traps**

**S-Traps**

**End Outlets**

**Center Outlets**

**Disposer Wastes**

**Sink Tailpieces  
& Extensions**

**Branch Tailpieces**

**Waste Arms**

**Threaded Tube**

**Accessories**

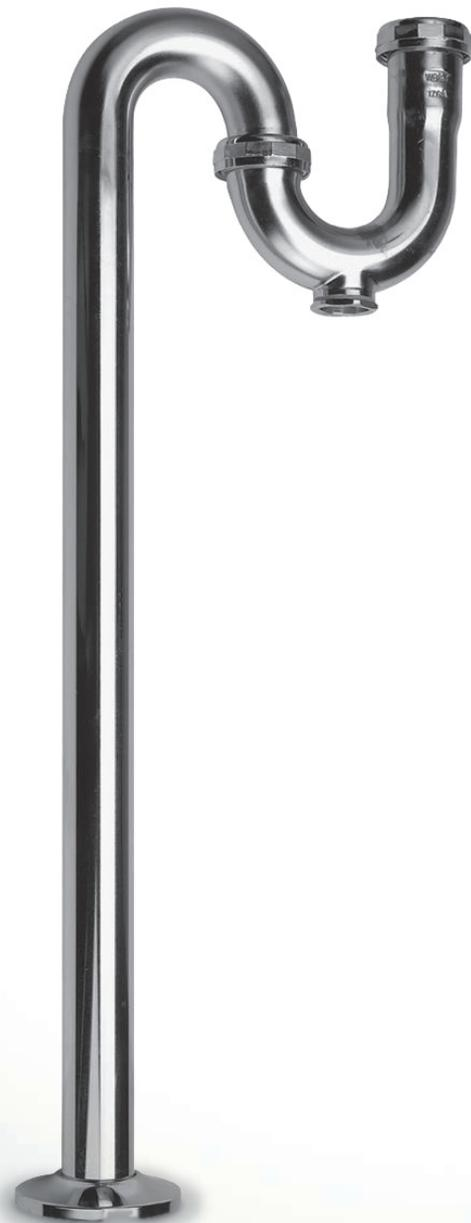



**240-0151C04**  
Page 575



**240-08648R104**  
Page 576



**240-20825C04**  
Page 577



**240-1052C04**  
Page 578



**240-1151C04**  
Page 578



**240-1551C12**  
Page 579



**240-276116C04**  
Page 579



**240-316116C04**  
Page 580



**240-336213C04**  
Page 580



**240-405104C50**  
Page 580

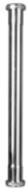

**240-465115C16**  
Page 582



**200-064**  
Page 583



**213-060**  
Page 584



**240-486124C04**  
Page



**240-616107C01**  
Page 585



**240-705206C50**  
Page 586



**240-8051C25**  
Page 587



**981-6**  
Page 588



**270-525**  
Page 588



**274-5**  
Page 589



**240-996208R116**  
Page 589

**P-Traps**

**Shallow Escutcheon**

Item Number	Item Description	Pkg Type	Min Qty	Case Qty	Price
<b>WITH SHALLOW ESCUTCHEON</b>					
240-0151C04	1-1/4" 22ga, Chrome, 1/Box	Bl	1	25	\$23.74
240-015212C04	1-1/4" w/ 12" Wall Tube, 20ga, Chrome, 1/Box	Bl	1	25	\$38.60
240-0152C04	1-1/4", 20ga, Chrome, 1/Box	Bl	1	25	\$27.28
240-015312C04	1-1/4" w/ 12" Wall Tube, 17ga, Chrome, 1/Box	Bl	1	25	\$40.21
240-01531C04	1-1/4" w/ Brass Nuts, 17ga, Chrome, 1/Box	Bl	1	25	\$39.78
240-0153C04	1-1/4", 17ga, Chrome, 1/Box	Bl	1	25	\$30.23
240-0161C04	1-1/2", 22ga, Chrome, 1/Box	Bl	1	25	\$29.51
240-0161R104	1-1/2", 22ga, Rough Brass, 1/Box	Bl	1	25	\$29.25
240-016215C04	1-1/2" w/ 12" Wall Tube, 20ga, Chrome, 1/Box	Bl	1	25	\$41.84
240-01621C04	1-1/2" w/ Brass Nuts, 20ga, Chrome, 1/Box	Bl	1	25	\$42.56
240-0162C04	1-1/2", 20ga, Chrome, 1/Box	Bl	1	25	\$37.95
240-0162R104	1-1/2", 20ga, Rough Brass, 1/Box	Bl	1	25	\$31.16
240-0163121C04	1-1/2" w/ 12" Wall Tube & Brass Nuts, 17ga, Chrome, 1/Box	Bl	1	25	\$52.82
240-016312C04	1-1/2" w/ 12" Wall Tube, 17ga, Chrome, 1/Box	Bl	1	25	\$48.03
240-01631C04	1-1/2" w/ Brass Nuts, 17ga, Chrome, 1/Box	Bl	1	25	\$46.46
240-0163C04	1-1/2", 17ga, Chrome, 1/Box	Bl	1	25	\$42.45
240-0163R104	1-1/2", 17ga, Rough Brass, 1/Box	Bl	1	25	\$37.62
<b>WITH CLEANOUT &amp; SHALLOW ESCUTCHEON</b>					
240-0452C04	1-1/4", 20ga, Chrome, 1/Box	Bl	1	25	\$37.11
240-0453C04	1-1/4", 17ga, Chrome, 1/Box	Bl	1	25	\$39.75
240-0454C04	1-1/4" w/ Cast Body, 17ga, Chrome, 1/Box	Bl	1	25	\$44.95
240-04571C04	1-1/4" w/ Cast Body & Brass Nuts, 17ga, Chrome, 1/Box	Bl	1	25	\$49.23
240-0462C04	1-1/2", 20ga, Chrome, 1/Box	Bl	1	25	\$41.80
240-04631C04	1-1/2" w/ Brass Nuts, 17ga, Chrome, 1/Box	Bl	1	25	\$45.36
240-0463C04	1-1/2", 17ga, Chrome, 1/Box	Bl	1	25	\$41.84
240-0464C04	1-1/2" w/ Cast Body, 17ga, Chrome, 1/Box	Bl	1	25	\$52.79
240-0467C04	1-1/2" w/ Cast Body & Brass Nuts, 17ga, Chrome, 1/Box	Bl	1	25	\$56.28
240-0487C04	1-1/2" x 1-1/4" w/ Cast Body, 17ga, Chrome, 1/Box	Bl	1	25	\$52.65
<b>LOW-INLET WITH SHALLOW ESCUTCHEON</b>					
240-01539C04	1-1/4" Low Inlet, 17ga, Chrome, 1/Box	Bl	1	25	\$43.25
240-01639C04	1-1/2" Low Inlet, 17ga Chrome, 1/Box	Bl	1	25	\$49.43
<b>CHOKE NECK WITH SHALLOW ESCUTCHEON</b>					
240-01831C04	1-1/2" x 1-1/4" w/ Brass Nuts, 17ga, Chrome, 1/Box	Bl	1	25	\$40.71
<b>GROUND JOINT WITH SHALLOW ESCUTCHEON</b>					
240-06631C04	1-1/2" w/ Brass Nuts, 17ga, Chrome, 1/Box	Bl	1	25	\$41.26



240-0151C04



240-0452C04



240-01539C04



240-01831C04



240-06631C04

Supply

Drainage

Support

Specialties

Appendix

Supply



240-0252C04

Drainage



240-0553C04

Support

Specialties

Appendix



240-03531C04



240-05B531C04



240-08648R104

### P-Traps

#### Deep Bell Escutcheon

Item Number	Item Description	Pkg Type	Min Qty	Case Qty	Price
<b>WITH DEEP BELL ESCUTCHEON</b>					
240-0252C04	1-1/4", 20ga, Chrome, 1/Box	BI	1	25	\$28.34
240-025315C04	1-1/4" w/ 12" Wall Tube, 17ga, Chrome, 1/Box	BI	1	25	\$40.21
240-02531C04	1-1/4" w/ Brass Nuts, 17ga, Chrome, 1/Box	BI	1	25	\$40.94
240-0253C04	1-1/4", 17ga, Chrome, 1/Box	BI	1	25	\$31.11
240-0261C04	1-1/2", 22ga, Chrome, 1/Box	BI	1	25	\$33.01
240-0262C04	1-1/2", 20ga, Chrome, 1/Box	BI	1	25	\$38.80
240-026312C04	1-1/2" w/ 12" Wall Tube, 17ga, Chrome, 1/Box	BI	1	25	\$42.79
240-02631C04	1-1/2" w/ Brass Nuts, 17ga, Chrome, 1/Box	BI	1	25	\$42.02
240-0263C04	1-1/2", 17ga, Chrome, 1/Box	BI	1	25	\$38.48
<b>WITH CLEANOUT &amp; DEEP BELL ESCUTCHEON</b>					
240-0553C04	1-1/4", 17ga, Chrome, 1/Box	BI	1	25	\$46.53
240-05541C04	1-1/4" w/ Cast Body & Brass Nuts, 17ga, Chrome, 1/Box	BI	1	25	\$57.75
240-0554C04	1-1/4" w/ Cast Body, 17ga, Chrome, 1/Box	BI	1	25	\$50.23
240-0563C04	1-1/2", 17ga, Chrome, 1/Box	BI	1	25	\$46.35
240-0564C04	1-1/2" w/ Cast Body, 17ga, Chrome, 1/Box	BI	1	25	\$63.35

### P-Traps

#### Deep Box Escutcheon

Item Number	Item Description	Pkg Type	Min Qty	Case Qty	Price
<b>WITH DEEP BOX ESCUTCHEON</b>					
240-03531C04	1-1/4" w/ Brass Nuts, 17ga, Chrome, 1/Box	BI	1	25	\$35.83
240-0353C04	1-1/4", 17ga, Chrome, 1/Box	BI	1	25	\$31.79
240-03631C04	1-1/2" w/ Brass Nuts, 17ga, Chrome, 1/Box	BI	1	25	\$41.76
240-0363C04	1-1/2", 17ga, Chrome, 1/Box	BI	1	25	\$39.18
<b>WITH CLEANOUT &amp; DEEP BOX ESCUTCHEON</b>					
240-05B531C04	1-1/4" w/ Brass Nuts, 17ga, Chrome, 1/Box	BI	1	25	\$41.14
240-05B631C04	1-1/2" w/ Brass Nuts, 17ga, Chrome, 1/Box	BI	1	25	\$47.10

### P-Traps

#### Regulation

Item Number	Item Description	Pkg Type	Min Qty	Case Qty	Price
<b>REGULATION P-TRAPS</b>					
240-08648R104	L.A. Trap, 1-1/2" Slip Joint x 1-1/2" FIP, Cast Brass, Rough Brass, 1/Box	BI	1	5	\$49.56
240-08688R104	L.A. Trap, 1-1/2" Slip Joint x 1-1/2" Sweat, Cast Brass, Rough Brass, 1/Box	BI	1	5	\$49.97
240-08848C04	L.A. Trap, 1-1/4" Slip Joint x 1-1/2" FIP, Cast Brass, Chrome, 1/Box	BI	1	5	\$67.07
240-08948R104	L.A. Trap, 1-1/2" Slip Joint x 2" FIP, Cast Brass, Rough Brass, 1/Box	BI	1	5	\$114.55



**P-Traps (Cont)**

**Regulation**

Item Number	Item Description	Pkg Type	Min Qty	Case Qty	Price
<b>WITH CLEANOUT</b>					
240-09648R104	L.A. Trap, 1-1/2" Slip Joint x 1-1/2" FIP, Cast Brass, Rough Brass, 1/Box	BI	1	5	\$58.39
240-09847C04	N.Y. Trap, 1-1/4" Slip Joint x 1-1/2" FIP, Cast Brass, Chrome, 1/Box	BI	1	5	\$68.32
240-09847R104	N.Y. Trap, 1-1/4" Slip Joint x 1-1/2" FIP, Cast Brass, Rough Brass, 1/Box	BI	1	5	\$49.69
240-09848C04	L.A. Trap, 1-1/4" Slip Joint x 1-1/2" FIP, Cast Brass, Chrome, 1/Box	BI	1	5	\$72.74
240-09947C04	N.Y. Trap, 1-1/2" Slip Joint x 2" FIP, Cast Brass, Chrome, 1/Box	BI	1	5	\$74.86
240-09947R104	N.Y. Trap 1-1/2" Slip Joint x 2" FIP, Cast Brass, Rough Brass, 1/Box	BI	1	5	\$54.25
240-09988R104	L.A. Trap, 1-1/2" Slip Joint x 2" Sweat, Cast Brass, Rough Brass, 1/Box	BI	1	5	\$101.56



240-09847R104

**P-Traps**

**Utility Traps**

Item Number	Item Description	Pkg Type	Min Qty	Case Qty	Price
<b>UTILITY P-TRAPS</b>					
240-19875C04	Milwaukee Trap, 1-1/4" Slip Joint x 1-1/2" MIP, 17ga, Chrome, 1/Box	BI	1	25	\$57.57
<b>WITH CLEANOUT</b>					
240-20825C04	Milwaukee Trap, 1-1/4" Slip Joint x 1-1/2" MIP, 20ga, Chrome, 1/Box	BI	1	25	\$54.27
240-20835C04	Milwaukee Trap, 1-1/4" Slip Joint x 1-1/2" MIP, 17ga, Chrome, 1/Box	BI	1	25	\$61.26



240-19875C04



240-20825C04

**P-Traps**

**Adjustable Sink Trap**

Item Number	Item Description	Pkg Type	Min Qty	Case Qty	Price
240-2267C04	Swivel Sink Trap, 1-1/2" Slip Joint x 1-1/2" FIP, 17ga, Chrome, 1/Box	BI	1	25	\$36.25
240-22836C04	Washington Swivel Sink Trap, 1-1/4" Slip Joint x 1-1/2" FIP, 20ga, Chrome, 1/Box	BI	1	25	\$32.92
240-2287C04	L.A. Swivel Sink Trap, 1-1/4" Slip Joint x 1-1/2" FIP, 17ga, Chrome, 1/Box	BI	1	25	\$60.51



240-2267C04

**P-Traps**

**Swing Tee**

Item Number	Item Description	Pkg Type	Min Qty	Case Qty	Price
240-9394R104	1-1/2" Slip Joint x 1-1/2" Slip Joint x 2" FIP w/ Cleanout, Rough Cast Brass, 1/Box	BI	1	15	\$85.49



240-9394R104

Supply

Drainage

Support

Specialties

Appendix

Supply

Drainage

Support

Specialties

Appendix



240-1052C04



240-1151C04



240-1453C04



240-12531C04



240-13531C04



240-1861C04

### P-Traps

#### Repair P-Trap

Item Number	Item Description	Pkg Type	Min Qty	Case Qty	Price
240-1052C04	1-1/4", 20ga, Chrome, 1/Box	BI	1	25	\$34.40
240-1062C04	1-1/2", 20ga, Chrome, 1/Box	BI	1	25	\$39.26

### S-Traps

Item Number	Item Description	Pkg Type	Min Qty	Case Qty	Price
<b>WITH SHALLOW ESCUTCHEON</b>					
240-1151C04	1-1/4", 22ga, Chrome, 1/Box	BI	1	12	\$44.28
240-1152C04	1-1/4", 20ga, Chrome, 1/Box	BI	1	12	\$46.57
240-1153C04	1-1/4", 17ga, Chrome, 1/Box	BI	1	12	\$53.47
240-1161C04	1-1/2", 22ga, Chrome, 1/Box	BI	1	12	\$48.58
240-1162C04	1-1/2", 20ga, Chrome, 1/Box	BI	1	12	\$51.41
240-1163C04	1-1/2", 17ga, Chrome, 1/Box	BI	1	12	\$59.93
<b>WITH CLEANOUT &amp; SHALLOW ESCUTCHEON</b>					
240-1453C04	1-1/4", 17ga, Chrome, 1/Box	BI	1	12	\$66.33
240-1463C04	1-1/2", 17ga, Chrome, 1/Box	BI	1	12	\$73.79
<b>DEEP BELL ESCUTCHEON</b>					
240-12531C04	1-1/4" w/ Brass Nuts, 17ga, Chrome, 1/Box	BI	1	12	\$55.18
240-12631C04	1-1/2" w/ Brass Nuts, 17ga, Chrome, 1/Box	BI	1	12	\$60.94
<b>DEEP BOX ESCUTCHEON</b>					
240-1352C04	1-1/4", 20ga, Chrome, 1/Box	BI	1	12	\$46.51
240-13531C04	1-1/4" w/ Brass Nuts, 17ga, Chrome, 1/Box	BI	1	12	\$57.24
240-1353C04	1-1/4", 17ga, Chrome, 1/Box	BI	1	12	\$51.37
240-1362C04	1-1/2", 20ga, Chrome, 1/Box	BI	1	12	\$50.35
240-13631C04	1-1/2" w/ Brass Nuts, 17ga, Chrome, 1/Box	BI	1	12	\$60.94
<b>WASHING MACHINE TRAPS</b>					
240-1861C04	1-1/2", 22ga, Chrome, 1/Box	BI	1	12	\$63.35

**Trap Accessories**

Item Number	Item Description	Pkg Type	Min Qty	Case Qty	Price
<b>J-BENDS FOR P-TRAPS &amp; S-TRAPS</b>					
240-1551C12	1-1/4", 22ga, Chrome, 1/Box	Bl	1	12	\$17.27
240-1552C04	1-1/4", 20ga, Chrome, 1/Box	Bl	1	25	\$19.03
240-1553C04	1-1/4", 17ga, Chrome, 1/Box	Bl	1	25	\$23.51
240-1561C01	1-1/2", 22ga, Chrome, 1/Box	Bl	1	12	\$20.27
240-1562C04	1-1/2", 20ga, Chrome, 1/Box	Bl	1	25	\$22.46
240-1563C04	1-1/2", 17ga, Chrome, 1/Box	Bl	1	25	\$24.63
<b>J-BENDS FOR S-TRAPS</b>					
240-1661C04	1-1/2", 22ga, Chrome, 1/Box	Bl	1	25	\$17.38
240-1662C04	1-1/2", 20ga, Chrome, 1/Box	Bl	1	25	\$22.17
240-1663C04	1-1/2", 17ga, Chrome, 1/Box	Bl	1	25	\$24.99
<b>LOW-INLET J-BENDS</b>					
240-2163C04	1-1/2" Low-Inlet, 17ga, Chrome, 1/Box	Bl	1	25	\$24.60
<b>WALL BENDS</b>					
240-175107C24	1-1/4" x 7", 22ga, Chrome, 1/Bag	Bl	1	24	\$10.78
240-176107C24	1-1/2" x 7", 22ga, Chrome, 1/Bag	Bl	1	24	\$12.39
240-176212C24	1-1/2" x 12", 20ga, Chrome, 1/Bag	Bl	1	24	\$18.79
240-176307C24	1-1/2" x 7", 17ga, Chrome, 1/Bag	Bl	1	24	\$16.38
<b>COVER TUBE - WIDE BELL</b>					
240-98720625	2" x 6", Chrome, 1/Bag	Bl	1	100	\$18.03



240-1551C12



240-1661C04



240-2163C04



240-175107C24



240-98720625

**End Outlets**

Item Number	Item Description	Pkg Type	Min Qty	Case Qty	Price
<b>SLIP JOINT</b>					
240-276116C04	1-1/2" x 16", 22ga, Chrome, 1/Box	Bl	1	25	\$52.15
240-276121C04	1-1/2" x 21", 22ga, Chrome, 1/Box	Bl	1	25	\$60.17
240-276216C04	1-1/2" x 16", 20ga, Chrome, 1/Box	Bl	1	25	\$56.31
240-276221C04	1-1/2" x 21", 20ga, Chrome, 1/Box	Bl	1	25	\$64.67
240-276316C04	1-1/2" x 16", 17ga, Chrome, 1/Box	Bl	1	25	\$61.93
240-276321C04	1-1/2" x 21", 17ga, Chrome, 1/Box	Bl	1	25	\$71.36



240-276116C04

Supply

Drainage

Support

Specialties

Appendix

Supply



240-286116C04

Drainage



240-306116C04

Support



240-316116C04

Specialties

Appendix



240-336213C04



240-405104C50

### End Outlets (Cont)

Item Number	Item Description	Pkg Type	Min Qty	Case Qty	Price
<b>DIRECT CONNECT</b>					
240-286116C04	1-1/2" x 16", 22ga, Chrome, 1/Box	BI	1	25	\$54.52
240-286216C04	1-1/2" x 16", 20ga, Chrome, 1/Box	BI	1	25	\$60.21
240-2863161C04	1-1/2" x 16" w/ Brass Nuts, 17ga, Chrome, 1/Box	BI	1	25	\$67.05

### Center Outlets

Item Number	Item Description	Pkg Type	Min Qty	Case Qty	Price
<b>SLIP JOINT</b>					
240-306116C04	1-1/2" x 16", 22ga, Chrome, 1/Box	BI	1	25	\$53.04
240-306121C04	1-1/2" x 21", 22ga, Chrome, 1/Box	BI	1	25	\$61.05
240-3062161C04	1-1/2" x 21", 20ga, Chrome, 1/Box	BI	1	25	\$69.77
240-306216C04	1-1/2" x 16", 20ga, Chrome, 1/Box	BI	1	25	\$61.82
240-3063161C04	1-1/2" x 16" w/ Brass Nuts, 17ga, Chrome, 1/Box	BI	1	25	\$67.71
<b>DIRECT CONNECT</b>					
240-316116C04	1-1/2" x 16", 22ga, Chrome, 1/Box	BI	1	25	\$56.41
240-316216C04	1-1/2" x 16", 20ga, Chrome, 1/Box	BI	1	25	\$62.22
240-316316C04	1-1/2" x 16", 17ga, Chrome, 1/Box	BI	1	25	\$67.71

### Disposer Waste

Item Number	Item Description	Pkg Type	Min Qty	Case Qty	Price
240-336213C04	1-1/2" x 13", 20ga, w/ ISE® Gasket, Chrome, 1/Box	BI	1	25	\$63.58
240-336313C04	1-1/2" x 13", 17ga, w/ ISE® Gasket, Chrome, 1/Box	BI	1	25	\$71.53

### Sink Tailpieces

Item Number	Item Description	Pkg Type	Min Qty	Case Qty	Price
<b>REDUCING FLANGED</b>					
240-405104C50	1-1/2" x 1-1/4" x 4", 22ga, Chrome, 1/Bag	BI	1	50	\$7.25
240-405106C50	1-1/2" x 1-1/4" x 6", 22ga, Chrome, 1/Bag	BI	1	50	\$8.32
240-405108C25	1-1/2" x 1-1/4" x 8", 22ga, Chrome, 1/Bag	BI	1	25	\$10.75
240-405112C25	1-1/2" x 1-1/4" x 12", 22ga, Chrome, 1/Bag	BI	1	25	\$14.78

**Sink Tailpieces (Cont)**

Item Number	Item Description	Pkg Type	Min Qty	Case Qty	Price
<b>SINGLE FLANGED</b>					
240-406104C50	1-1/2" x 4", 22ga, Chrome, 1/Bag	Bl	1	50	\$6.84
240-406106C50	1-1/2" x 6", 22ga, Chrome, 1/Bag	Bl	1	50	\$7.73
240-406106R150	1-1/2" x 6", 22ga, Rough Brass, 1/Bag	Bl	1	50	\$8.67
240-406108C25	1-1/2" x 8", 22ga, Chrome, 1/Bag	Bl	1	25	\$11.41
240-406112C25	1-1/2" x 12", 22ga, Chrome, 1/Bag	Bl	1	25	\$15.09
240-406112R125	1-1/2" x 12", 22ga, Rough Brass, 1/Bag	Bl	1	25	\$14.18
240-406118R125	1-1/2" x 18", 22ga, Rough Brass, 1/Bag	Bl	1	25	\$21.69
240-406124R125	1-1/2" x 24", 22ga, Rough Brass, 1/Bag	Bl	1	25	\$28.97
240-406204C50	1-1/2" x 4", 20ga, Chrome, 1/Bag	Bl	1	50	\$7.99
240-406206C50	1-1/2" x 6", 20ga, Chrome, 1/Bag	Bl	1	50	\$8.72
240-406206R150	1-1/2" x 6", 20ga, Rough Brass, 1/Bag	Bl	1	50	\$7.48
240-406208C25	1-1/2" x 8", 20ga, Chrome, 1/Bag	Bl	1	25	\$11.09
240-406212C25	1-1/2" x 12", 20ga, Chrome, 1/Bag	Bl	1	25	\$18.00
240-406212R125	1-1/2" x 12", 20ga, Rough Brass, 1/Bag	Bl	1	25	\$13.85
240-406306C50	1-1/2" x 6", 17ga, Chrome, 1/Bag	Bl	1	50	\$12.27
240-406308C25	1-1/2" x 8", 17ga, Chrome, 1/Bag	Bl	1	25	\$16.30
240-406308R125	1-1/2" x 8", 17ga, Rough Brass, 1/Bag	Bl	1	25	\$14.48
240-406312C25	1-1/2" x 12", 17ga, Chrome, 1/Bag	Bl	1	25	\$19.46
240-406312R125	1-1/2" x 12", 17ga, Rough Brass, 1/Bag	Bl	1	25	\$16.45
<b>DOUBLE FLANGED</b>					
240-416116C25	1-1/2" x 16", 22ga, Chrome, 1/Bag	Bl	1	25	\$20.86
240-416216C25	1-1/2" x 16", 20ga, Chrome, 1/Bag	Bl	1	25	\$28.69
240-416316C25	1-1/2" x 16", 17ga, Chrome, 1/Bag	Bl	1	25	\$34.53



240-406104C50



240-416116C25

Supply

Drainage

Support

Specialties

Appendix

**Extensions**

Item Number	Item Description	Pkg Type	Min Qty	Case Qty	Price
<b>SLIP</b>					
240-455106C32	1-1/4" x 6", 22ga, Chrome, 1/Bag	BI	1	32	\$11.07
240-455108C16	1-1/4" x 8", 22ga, Chrome, 1/Bag	BI	1	16	\$12.65
240-455112C16	1-1/4" x 12", 22ga, Chrome, 1/Bag	BI	1	16	\$15.97
240-455112R116	1-1/4" x 12", 22ga, Rough Brass, 1/Bag	BI	1	16	\$11.51
240-455206C32	1-1/4" x 6", 20ga, Chrome, 1/Bag	BI	1	32	\$14.77
240-455208C16	1-1/4" x 8", 20ga, Chrome, 1/Bag	BI	1	16	\$19.25
240-455212C16	1-1/4" x 12", 20ga, Chrome, 1/Bag	BI	1	16	\$22.51
240-455306C32	1-1/4" x 6", 17ga, Chrome, 1/Bag	BI	1	32	\$16.97
240-455308C16	1-1/4" x 8", 17ga, Chrome, 1/Bag	BI	1	16	\$19.05
240-455312C16	1-1/4" x 12", 17ga, Chrome, 1/Bag	BI	1	16	\$25.23
240-456106C32	1-1/2" x 6", 22ga, Chrome, 1/Bag	BI	1	32	\$12.65
240-456108C16	1-1/2" x 8", 22ga, Chrome, 1/Bag	BI	1	16	\$14.21
240-4561106C32	1-1/2" x 6" w/ Brass Nuts, 22ga, Chrome, 1/Bag	BI	1	32	\$14.80
240-4561112C16	1-1/2" x 12" w/ Brass Nuts, 22ga, Chrome, 1/Bag	BI	1	16	\$19.05
240-456112C16	1-1/2" x 12", 22ga, Chrome, 1/Bag	BI	1	16	\$17.96
240-456112R106	1-1/2" x 12", 22ga, Rough Brass, 1/Bag	BI	1	16	\$16.64
240-456206C16	1-1/2" x 6", 20ga, Chrome, 1/Bag	BI	1	16	\$14.37
240-456208C16	1-1/2" x 8", 20ga, Chrome, 1/Bag	BI	1	16	\$16.35
240-456212C16	1-1/2" x 12", 20ga, Chrome, 1/Bag	BI	1	16	\$23.98
240-456306C32	1-1/2" x 6", 17ga, Chrome, 1/Bag	BI	1	32	\$15.84
240-456308C16	1-1/2" x 8", 17ga, Chrome, 1/Bag	BI	1	16	\$19.01
240-4563121C16	1-1/2" x 12" w/ Brass Nuts, 17ga, Chrome, 1/Bag	BI	1	16	\$24.33
240-4563121R116	1-1/2" x 12" w/ Brass Nuts, 17ga, Rough Brass, 1/Bag	BI	1	16	\$22.70
240-456312C16	1-1/2" x 12", 17ga, Chrome, 1/Bag	BI	1	16	\$24.33
<b>DOUBLE SLIP</b>					
240-465115C16	1-1/4" x 16", 22ga, Chrome, 1/Bag	BI	1	16	\$21.21
240-466116C16	1-1/2" x 16", 22ga, Chrome, 1/Bag	BI	1	16	\$23.65
240-466216C16	1-1/2" x 16", 20ga, Chrome, 1/Bag	BI	1	16	\$35.52
<b>SOLDER JOINT</b>					
240-475106C50	1-1/4" x 6", 22ga, Chrome, 1/Bag	BI	1	50	\$9.17
240-475108C25	1-1/4" x 8", 22ga, Chrome, 1/Bag	BI	1	25	\$11.34
240-475112C25	1-1/4" x 12", 22ga, Chrome, 1/Bag	BI	1	25	\$15.98
240-476106C01	1-1/2" x 6", 22ga, Chrome, 1/Bag	BI	1	25	\$13.55
240-476108C25	1-1/2" x 8", 22ga, Chrome, 1/Bag	BI	1	25	\$15.98
240-476112C25	1-1/2" x 12", 22ga, Chrome, 1/Bag	BI	1	25	\$20.15
240-476212C25	1-1/2" x 12", 20ga, Chrome, 1/Bag	BI	1	25	\$23.96



Supply

Drainage

Support

Specialties

Appendix

**Branch Tailpieces**

**LongBranch™ Dishwasher Tailpieces**

**Related Products**

Trap-Ease™ Primer Tailpiece p 150

Item Number	Item Description	Pkg Type	Min Qty	Case Qty	Price
<b>DOMESTIC - 1/2" DIRECT CONNECT</b>					
200-062	1-1/2" x 6" x 1/2" Branch w/ Die Cast Zinc Nut, 22ga, Rough Brass	B	25	25	\$14.50
200-064	1-1/2" x 6" x 1/2" Branch w/ Solid Brass Nut, 22ga, Rough Brass	B	25	25	\$15.35
200-066	1-1/2" x 6" x 1/2" Branch w/ Solid Brass Nut, 22ga, Chrome	B	25	25	\$19.51
200-082	1-1/2" x 8" x 1/2" Branch w/ Die Cast Zinc Nut, 22ga, Rough Brass	B	25	25	\$15.32
200-084	1-1/2" x 8" x 1/2" Branch w/ Solid Brass Nut, 22ga, Rough Brass	B	25	25	\$18.05
200-122	1-1/2" x 12" x 1/2" Branch w/ Die Cast Zinc Nut, 22ga, Rough Brass	B	25	25	\$20.20
200-124	1-1/2" x 12" x 1/2" Branch w/ Solid Brass Nut, 22ga, Domestic, Rough Brass	B	25	25	\$21.03
<b>DOMESTIC - 1/2" SLIP JOINT</b>					
206-064	1-1/2" x 6" x 1/2" Branch w/ Solid Brass Nut, 22ga, Rough Brass	B	25	25	\$20.66
206-066	1-1/2" x 6" x 1/2" Branch w/ Solid Brass Nut, 22ga, Chrome	B	25	25	\$26.66
206-084	1-1/2" x 8" x 1/2" Branch w/ Solid Brass Nut, 22ga, Rough Brass	B	25	25	\$24.06



**Branch Tailpieces**

**Dishwasher**

Item Number	Item Description	Pkg Type	Min Qty	Case Qty	Price
<b>DOMESTIC - DIRECT CONNECT</b>					
210-064	1-1/2" x 6" x 3/4" Branch w/ Solid Brass Nut, 22ga, Rough Brass	B	25	25	\$15.33
210-066	1-1/2" x 6" x 3/4" Branch w/ Solid Brass Nut, 22ga, Chrome	B	25	25	\$20.27
210-084	1-1/2" x 8" x 3/4" Branch w/ Solid Brass Nut, 22ga, Rough Brass	B	25	25	\$17.13
210-086	1-1/2" x 8" x 3/4" Branch w/ Solid Brass Nut, 22ga, Chrome	B	25	25	\$19.69
210-122	1-1/2" x 12" x 3/4" Branch w/ Die Cast Zinc Nut, 22ga, Rough Brass	B	25	25	\$21.84
<b>DOMESTIC - SLIP JOINT</b>					
216-084	1-1/2" x 8" x 3/4" Branch w/ Solid Brass Nut, 22ga, Rough Brass	B	25	25	\$22.61
216-086	1-1/2" x 8" x 3/4" Branch w/ Solid Brass Nut, 22ga, Chrome	B	25	25	\$24.07



Supply

Drainage

Support

Specialties

Appendix

### Branch Tailpieces (Cont)

#### Dishwasher

Item Number	Item Description	Pkg Type	Min Qty	Case Qty	Price
<b>IMPORT - DIRECT CONNECT</b>					
207-06325	1-1/2" x 6" x 1/2" Branch w/ Brass Nut, 22ga, Chrome, 1/Bag	B	25	25	\$26.58
207-08325	1-1/2" x 8" x 1/2" Branch w/ Die Cast Zinc Nut, 22ga, Chrome, 1/Bag	B	25	25	\$20.37
207-08425	1-1/2" X 8" X 1/2" Branch w/ Brass Nut - Chrome	B	25	25	\$27.73
207-12425	1-1/2" x 12" x 1/2" Branch w/ Solid Brass Nut, 17ga, Rough Brass	B	25	25	\$33.27
210-12225	1-1/2" x 12" x 3/4" Branch w/ Die Cast Zinc Nut, 22ga, Rough Brass	B	1	25	\$18.49
210-38625	1-1/2" x 8" x Dual Branch ( 1/2" CTS x 3/4" MHT) w/ Die Cast Zinc Nut, 22ga, Chrome	B	25	25	\$24.28
<b>IMPORT - LONG BRANCH™ DIRECT CONNECT</b>					
200-12225	1-1/2" x 12" x 1/2" Branch w/ Solid Brass Nut, 22ga, Imported, Rough Brass	B	25	25	\$14.44
<b>IMPORT - ALL PURPOSE</b>					
210-28625	1-1/2" x 8" x 3/4" Branch w/ Die Cast Zinc Nut, 22ga, Chrome, 1/Bag	B	25	25	\$26.61



210-38625



200-12225



210-28625

### Branch Tailpieces

#### Lavatory

Item Number	Item Description	Pkg Type	Min Qty	Case Qty	Price
<b>DOMESTIC - FINE THREAD</b>					
213-060	1-1/4" x 6" x 3/4" Branch, 20ga, Rough Brass	B	25	25	\$18.06
213-068	1-1/4" x 6" x 3/4" Branch, 20ga, Chrome	B	25	25	\$23.52
<b>DOMESTIC - FINE THREAD x FINE THREAD</b>					
213-061	1-1/4" x 6" x 3/4" Branch, 20ga, Rough Brass	B	25	25	\$18.52
<b>DOMESTIC - SLIP JOINT</b>					
215-064	1-1/4" x 6" x 3/4" Branch, 22ga, Rough Brass	B	25	25	\$19.58
215-066	1-1/4" x 6" x 3/4" Branch, 22ga, Chrome	B	25	25	\$25.23



213-060



213-061



215-064

Supply

Drainage

Support

Specialties

Appendix



**Branch Tailpieces**

**MajorTee™**

Item Number	Item Description	Pkg Type	Min Qty	Case Qty	Price
<b>DOMESTIC - FINE THREAD</b>					
213-067	1-1/4" x 6" x 3/4" MIP Branch, Rough Brass	B	25	25	\$23.97
213-069	1-1/4" x 6" x 3/4" Branch, Rough Brass	B	25	25	\$17.63



213-069

**Waste Arms**

**Waste Bend**

Item Number	Item Description	Pkg Type	Min Qty	Case Qty	Price
<b>SLIP JOINT</b>					
240-606107C01	1-1/2" x 7", 22ga, Chrome, 1/Bag	Bl	1	25	\$16.19
240-606108R124	1-1/2" x 8", 22ga, Rough Brass, 1/Bag	Bl	1	24	\$16.06
240-606111C24	1-1/2" x 11-1/2", 22ga, Chrome, 1/Bag	Bl	1	24	\$20.05
240-606111R124	1-1/2" x 11-1/2", 22ga, Rough Brass, 1/Bag	Bl	1	24	\$20.48
240-606115C24	1-1/2" x 15", 22ga, Chrome, 1/Bag	Bl	1	24	\$25.00
240-606118R124	1-1/2" x 18", 22ga, Rough Brass, 1/Bag	Bl	1	24	\$24.29
240-606124R124	1-1/2" x 24", 22ga, Rough Brass, 1/Bag	Bl	1	24	\$32.55
240-606136R124	1-1/2" x 36", 22ga, Rough Brass, 1/Bag	Bl	1	24	\$39.07
240-606211C24	1-1/2" x 11-1/2", 20ga, Chrome, 1/Bag	Bl	1	24	\$29.37
240-606215C24	1-1/2" x 15", 20ga, Chrome, 1/Bag	Bl	1	24	\$33.86
240-606224R124	1-1/2" x 24", 20ga, Rough Brass, 1/Bag	Bl	1	24	\$43.85
240-6063111C24	1-1/2" x 11-1/2" w/ Brass Nut, 17ga, Chrome, 1/Bag	Bl	1	24	\$29.41
240-6063112R124	1-1/2" x 12" w/ Brass Nut, 17ga, Rough Brass, 1/Bag	Bl	1	24	\$31.39
240-6063181R124	1-1/2" x 18" w/ Brass Nut, 17ga, Rough Brass, 1/Bag	Bl	1	24	\$41.07
240-6063241C24	1-1/2" x 24" w/ Brass Nut, 17ga, Chrome, 1/Bag	Bl	1	24	\$60.58
240-6063241R124	1-1/2" x 24" w/ Brass Nut, 17ga, Rough Brass, 1/Bag	Bl	1	24	\$52.59
<b>DIRECT CONNECT</b>					
240-616107C01	1-1/2" x 7", 22ga, Chrome, 1/Bag	Bl	1	24	\$12.78
240-616111C24	1-1/2" x 11-1/2", 22ga, Chrome, 1/Bag	Bl	1	24	\$18.21
240-616111R124	1-1/2" x 11-1/2", 22ga, Rough Brass, 1/Bag	Bl	1	24	\$15.05
240-616115C24	1-1/2" x 15", 22ga, Chrome, 1/Bag	Bl	1	24	\$21.78
240-616115R124	1-1/2" x 15", 22ga, Rough Brass, 1/Bag	Bl	1	24	\$16.26
240-616124C24	1-1/2" x 24", 22ga, Chrome, 1/Bag	Bl	1	24	\$31.74
240-616124R124	1-1/2" x 24", 22ga, Rough Brass, 1/Bag	Bl	1	24	\$23.03
240-616215C24	1-1/2" x 15", 20ga, Chrome, 1/Bag	Bl	1	24	\$35.53
240-616311C24	1-1/2" x 11", 17ga, Chrome, 1/Bag	Bl	1	24	\$30.36
240-616311R124	1-1/2" x 11-1/2", 17ga, Rough Brass, 1/Bag	Bl	1	24	\$26.53
<b>SLIP JOINT x DIRECT CONNECT</b>					
240-626124R120	1-1/2" x 24", 22ga, Rough Brass, 1/Bag	Bl	1	20	\$28.23
<b>PLAIN END</b>					
240-636312R124	1-1/2" x 12" x 12", 17ga, Rough Brass, 1/Bag	Bl	1	24	\$45.46
240-636316R116	1-1/2" x 16" x 18", 17ga, Rough Brass, 1/Bag	Bl	1	16	\$72.23



240-606107C01



240-616107C01



240-626124R120



240-636312R124

Supply

Drainage

Support

Specialties

Appendix

**Threaded Tube**

Item Number	Item Description	Pkg Type	Min Qty	Case Qty	Price
<b>THREAD BOTH ENDS</b>					
240-703212C25	1-3/8" x 12", 20ga, Chrome, 1/Bag	BI	1	25	\$18.68
240-705206C50	1-1/4" x 6", 20ga, Chrome, 1/Bag	BI	1	50	\$8.46
240-705208C25	1-1/4" x 8", 20ga, Chrome, 1/Bag	BI	1	25	\$11.40
240-705212C25	1-1/4" x 12", 20ga, Chrome, 1/Bag	BI	1	25	\$13.66
240-705212R125	1-1/4" x 12", 20ga, Rough Brass, 1/Bag	BI	1	25	\$12.19
240-705312C25	1-1/4" x 12", 17ga, Chrome, 1/Bag	BI	1	25	\$20.11
240-705312R125	1-1/4" x 12", 17ga, Rough Brass, 1/Bag	BI	1	25	\$17.08
240-705318C25	1-1/4" x 18", 17ga, Chrome, 1/Bag	BI	1	25	\$24.49
240-706206C06	1-1/2" x 6", 20ga, Chrome, 1/Bag	BI	1	50	\$11.28
240-706208C25	1-1/2" x 8", 20ga, Chrome, 1/Bag	BI	1	25	\$13.57
240-706212C25	1-1/2" x 12", 20ga, Chrome, 1/Bag	BI	1	25	\$15.85
240-706212R125	1-1/2" x 12", 20ga, Rough Brass, 1/Bag	BI	1	25	\$13.40
240-706218R125	1-1/2" x 18", 20ga, Rough Brass, 1/Bag	BI	1	25	\$20.52
240-706224R125	1-1/2" x 24", 20ga, Rough Brass, 1/Bag	BI	1	25	\$27.48
240-706312C25	1-1/2" x 12", 17ga, Chrome, 1/Bag	BI	1	25	\$23.28
240-706312R125	1-1/2" x 12", 17ga, Rough Brass, 1/Bag	BI	1	25	\$20.08
240-706318R125	1-1/2" x 18", 17ga, Rough Brass, 1/Bag	BI	1	25	\$25.54
<b>THREAD ONE END</b>					
240-718108C25	1-1/2" x 1-1/4" x 8", 20ga, Chrome	BI	1	25	\$15.43



Supply

Drainage

Support

Specialties

Appendix

**Tubular Fittings**

Item Number	Item Description	Pkg Type	Min Qty	Case Qty	Price
<b>COUPLING</b>					
240-8051C25	1-1/4", 22ga, Chrome, 1/Bag	Bl	1	25	\$10.01
240-8061C25	1-1/2", 22ga, Chrome, 1/Bag	Bl	1	25	\$12.16
<b>ELBOW (90) - SLIP JOINT</b>					
240-8251C25	1-1/4", 22ga, Chrome, 1/Bag	Bl	1	25	\$29.91
240-8261C25	1-1/2", 22ga, Chrome, 1/Bag	Bl	1	25	\$26.85
<b>ELBOW (90) - SLIP JOINT × PLAIN END</b>					
240-825106C01	1-1/4" × 6", 22ga, Chrome, 1/Bag	Bl	1	24	\$15.43
240-825108C01	1-1/4" × 8", 22ga, Chrome, 1/Bag	Bl	1	12	\$18.16
240-825112C01	1-1/4" × 12", 22ga, Chrome, 1/Bag	Bl	1	12	\$20.45
<b>ELBOW (45) - SLIP JOINT</b>					
240-8451C25	1-1/4", 22ga, Chrome, 1/Bag	Bl	1	25	\$19.58
240-8461C25	1-1/2", 22ga, Chrome, 1/Bag	Bl	1	50	\$20.20
<b>TEE SLIP JOINT</b>					
240-8561R112	1-1/2", Rough Cast Brass, 1/Bag	Bl	1	12	\$23.29
240-8564C01	1-1/2", Cast Brass, Chrome, 1/Bag	Bl	1	12	\$30.84
<b>TEE - CENTER OUTLET - SLIP JOINT</b>					
240-8664C12	1-1/2", Cast Brass, Chrome, 1/Bag	Bl	1	12	\$35.45
<b>TEE - END OUTLET - SLIP JOINT</b>					
240-8764C06	1-1/2", Cast Brass, Chrome, 1/Bag	Bl	1	12	\$35.45
<b>TEE - END OUTLET - DIRECT CONNECT</b>					
240-8864C12	1-1/2", Cast Brass, Chrome, 1/Bag	Bl	1	12	\$35.78
<b>DOUBLE OFFSET - SLIP JOINT</b>					
240-9051C50	1-1/4", 22ga, Chrome, 1/Bag	Bl	1	50	\$21.91
240-9051R150	1-1/4", 22ga, Rough Brass, 1/Bag	Bl	1	50	\$19.22
240-9052C50	1-1/4", 20ga, Chrome, 1/Bag	Bl	1	50	\$27.24
240-9061C25	1-1/2", 22ga, Chrome, 1/Bag	Bl	1	50	\$23.77
240-9061R150	1-1/2", 22ga, Rough Brass, 1/Bag	Bl	1	50	\$20.58
240-9062C50	1-1/2", 20ga, Chrome, 1/Bag	Bl	1	50	\$29.72
240-90631C50	1-1/2" w/ Brass Nuts, 17ga, Chrome, 1/Bag	Bl	1	50	\$38.09
240-90631R150	1-1/2" w/ Brass Nutss, 17ga, Rough Brass, 1/Bag	Bl	1	50	\$32.32



240-8051C25



240-8251C25



240-825112R101



240-8451C25



240-8561R112



240-8664C12

Supply

Drainage

Support

Specialties

Appendix

Supply

Drainage

Support

Specialties

Appendix



981-6



985-5



995-20320



990-20385



996-8S



270-525

## Metal Tubular Accessories

### Nuts & Washers

Item Number	Item Description	Pkg Type	Min Qty	Case Qty	Price
<b>SLIP NUTS - SOLID BRASS</b>					
980-5	1-1/4", Chrome Plated Brass	B	50	500	\$2.65
980-6	1-1/2", Chrome Plated Brass	B	50	500	\$3.07
980-7	2", Chrome Plated Brass w/ Washer, 1/Bag	BI	10	100	\$7.27
980-8	1-1/2" x 1-1/4", Chrome Plated Brass	B	50	500	\$3.24
981-5	1-1/4", Rough Brass	B	50	500	\$2.45
981-6	1-1/2", Rough Brass	B	50	500	\$2.76
981-7	2", Rough Brass w/ Washer, 1/Bag	BI	10	100	\$6.71
981-8	1-1/2" x 1-1/4", Rough Brass	B	50	500	\$3.02
<b>SLIP NUTS - ZINC</b>					
985-5	1-1/4", Chrome Plated Zinc	B	50	500	\$1.31
985-6	1-1/2", Chrome Plated Zinc	B	50	500	\$1.43
985-8	1-1/2" x 1-1/4", Chrome Plated Zinc	B	50	500	\$1.81
986-6	1-1/2", Brass Plated Zinc	B	50	500	\$1.25
<b>SQUARE-CUT SLIP JOINT WASHERS</b>					
995-20320	1-1/4", 25/Bag	B	25	200	\$0.33
995-20330	1-1/2", 25/Bag	B	25	200	\$0.29
995-5	1-1/4", 100/Bag	B	100	1000	\$0.33
995-6	1-1/2", 100/Bag	B	100	1000	\$0.28
995-8	1-1/2" x 1-1/4", 100/Bag	B	100	1000	\$0.35
<b>CLOTH-INSERTED TAILPIECE WASHERS</b>					
990-20385	1-1/2", 25/Bag	B	25	300	\$0.57
990-7	1-1/2", 100/Bag	B	100	1000	\$0.54
<b>SOFT RED WASHERS - SLIP JOINT</b>					
996-5S	1-1/4" Red, Soft TPV	B	100	1000	\$0.23
996-6S	1-1/2" Red, Soft TPV	B	100	1000	\$0.20
996-8S	1-1/2" x 1-1/4" Red, Soft TPV	B	100	1000	\$0.23
<b>SOFT RED WASHERS - TAILPIECE</b>					
991-6S	1-1/2" Red, Soft TPV	B	100	1000	\$0.29

## Metal Tubular Accessories

### Desanco Fittings & Adapters

Item Number	Item Description	Pkg Type	Min Qty	Case Qty	Price
<b>DESANCO FITTINGS</b>					
270-525	1-1/4" OD x 1-1/4" MIP w/ Brass Ferrule & Die Cast Zinc Nut, 1/Bag	B	25	100	\$12.87
270-6	1-1/2" OD x 1-1/2" MIP w/ Brass Ferrule & Brass Nut, 1/Bag	B	25	25	\$13.22
272-5625	1-1/4" OD x 1-1/2" FIP w/ Brass Ferrule & Die Cast Zinc Nut, 1/Bag	B	25	100	\$14.95
272-6	1-1/2" OD x 1-1/2" FIP w/ Brass Ferrule & Brass Nut, 1/Bag	B	25	25	\$13.80

**Metal Tubular Accessories (Cont)**

**Desanco Fittings & Adapters**

Item Number	Item Description	Pkg Type	Min Qty	Case Qty	Price
<b>DWV SLIP JOINT ADAPTER</b>					
274-5	1-1/4" FSWT × 1-1/4" NPSM Thread, Brass	B	10	100	\$7.33
274-6	1-1/2" FSWT × 1-1/2" NPSM Thread, Brass	B	10	100	\$7.40
274-7	2" FSWT × 2" NPSM Thread, Brass	B	10	100	\$7.53



274-5

**Metal Tubular Accessories**

**Sink Funnel**

Item Number	Item Description	Pkg Type	Min Qty	Case Qty	Price
240-996208R116	1-1/2" × 8", Rough Brass, 1/Bag	Bl	1	50	\$22.14



240-996208R116

Supply

Drainage

Support

Specialties

Appendix



# Basket Strainers & Sink Drains

**Basket Strainers**

**Lav/Sink Drains**

Sioux Chief offers a wide variety of basket strainers, including popular designs like KwikFit™, Specification™, Champion® BigBoy™, Lok-Spin®, and many others.





**245-16440C04**  
Page 593



**245-16470C04**  
Page 593



**245-12832C04**  
Page 594



**245-16530C04**  
Page 594



**245-16462C04**  
Page 594



**245-13640C04**  
Page 594



**245-12530C04**  
Page 595



**245-52100C04**  
Page 595



**290-20553C04**  
Page 596



**290-20515C04**  
Page 596



**290-20630C04**  
Page 596



**290-20200**  
Page 597



**Basket Strainers**

**KwikFit™**

**Related Products**  
NoPutty™ Gaskets p 625

Item Number	Item Description	Pkg Type	Min Qty	Case Qty	Price
245-16440C04	Cup Style, Spring Post Basket, Stainless Steel w/ Zinc Nuts, Chrome, 1/Box	BI	1	20	\$13.20



245-16440C04

**Basket Strainers**

**Specification™**

Item Number	Item Description	Pkg Type	Min Qty	Case Qty	Price
245-16450C04	Deep Cup Style, Spring Post Basket, Stainless Steel w/ Zinc Nuts, Chrome, 1/Box	BI	1	20	\$24.70
245-16452C04	Deep Cup Style, Spring Post Basket, Stainless Steel w/ 2 Brass Nuts, Chrome, 1/Box	BI	1	20	\$33.97



245-16450C04

**Basket Strainers**

**Ball-Lok™**

Item Number	Item Description	Pkg Type	Min Qty	Case Qty	Price
245-16520C04	Cup Style, Snap Post Basket, Stainless Steel, Zinc Nuts, Chrome 1/Box	BI	1	50	\$21.86
245-16522C04	Cup Style, Snap Post Basket, Stainless Steel w/ 2 Brass Nuts, Chrome, 1/Box	BI	1	50	\$28.15



245-12732C04

**Basket Strainers**

**BigBoy™**

Item Number	Item Description	Pkg Type	Min Qty	Case Qty	Price
245-16470C04	Back Nut Style, Spring Post Basket, Stainless Steel w/ Zinc Nuts, Chrome, 1/Box	BI	1	24	\$15.28



245-16471C04

**Basket Strainers**

**Champion®**

Item Number	Item Description	Pkg Type	Min Qty	Case Qty	Price
245-16540C04	Back Nut Style, Spring Post Basket, Stainless Steel w/ Zinc Nuts, Chrome, 1/Box	BI	1	50	\$19.65



245-16540C04

Supply

Drainage

Support

Specialties

Appendix

Supply



245-12832C04

**Basket Strainers**

**ProBrite™**

Item Number	Item Description	Pkg Type	Min Qty	Case Qty	Price
245-12832C04	CBX Back Nut Style, Rubber Seal Basket, Cast Brass With 2 Brass Nuts, Bright Chrome, 1/Box	BI	1	5	\$37.48
245-16550C04	FPX Back Nut Style, Four Prong Basket, Stainless Steel w/ Zinc Nuts, Bright Chrome, 1/Box	BI	1	50	\$30.87
245-16560C04	SPX Back Nut Style, Stick Post Basket, Stainless Steel w/ Zinc Nuts, Bright Chrome, 1/Box	BI	1	50	\$30.87

Drainage

Support



245-16530C04

**Basket Strainers**

**Lok-Spin®**

Item Number	Item Description	Pkg Type	Min Qty	Case Qty	Price
245-16530C04	Back Nut Style, Stainless Steel w/ Zinc Nuts, Chrome, 1/Box	BI	1	24	\$26.06

Specialties



245-16462C04

**Basket Strainers**

**EezOn™**

Item Number	Item Description	Pkg Type	Min Qty	Case Qty	Price
245-16460C04	Thumbscrew Installation, Spring Post Basket, Stainless Steel w/ Zinc Nut, Chrome, 1/Box	BI	1	24	\$15.51
245-16462C04	Thumbscrew Installation, Spring Post Basket, Stainless Steel w/ Brass Nut, Chrome, 1/Box	BI	1	50	\$16.63

Appendix



245-13640C04

**Basket Strainers**

**SweetHeart™**

Item Number	Item Description	Pkg Type	Min Qty	Case Qty	Price
245-13640C04	Back Nut Style, Fixed Post Basket, Polypro Body & Nuts, Chrome, 1/Box	BI	1	50	\$9.57

**Basket Strainers**

**Duo Sink**



245-12930C04

Item Number	Item Description	Pkg Type	Min Qty	Case Qty	Price
245-12930C04	Back Nut Style, Fixed Post Basket, Stainless Steel w/ Zinc Nuts, Chrome, 1/Box	BI	1	50	\$11.76

**Basket Strainers**

**SIG Strainer™**

Item Number	Item Description	Pkg Type	Min Qty	Case Qty	Price
245-12530C04	"SIG" Snap-In-Grid Flat Sink Strainer, Stainless Steel w/ Zinc Nuts, Chrome, 1/Box	BI	1	50	\$13.61



245-12530C04

**Basket Strainers**

**Designer Series Double Cup**

Item Number	Item Description	Pkg Type	Min Qty	Case Qty	Price
245-16950B204	Cup Style, Celcon® Biscuit Finish Insert & Basket, 1/Clamshell	BI	1	5	\$33.75



245-16950B204

**Basket Strainers**

**Junior™ Bar Sink**

Item Number	Item Description	Pkg Type	Min Qty	Case Qty	Price
245-56400C01	3-In-1 Strainer w/ Duplex, Grid And Plug, Stainless Steel w/ Zinc Nuts, For 2-1/2" Opening, Chrome, 1/Bag	BI	1	100	\$10.26
<b>DEEP-CUP BAR SINK</b>					
245-52100C04	Deep Bail Basket, Stainless Steel w/ Zinc Nuts, For 2-1/2" Opening, Chrome, 1/Bag	BI	1	100	\$36.34



245-56400C01



245-52100C04

**Basket Strainers**

**Replacement Baskets**

Item Number	Item Description	Pkg Type	Min Qty	Case Qty	Price
245-96401C01	Fit All Drop Post Replacement Basket For Probrite™ CBX, Chrome, 1/Bag	BI	1	50	\$7.66
245-96440C01	Long Spring Post Replacement Basket For Kwik-Fit™, Chrome, 1/Bag	BI	1	25	\$7.66
245-96490C04	Stick Post Replacement Basket For Pro-Brite™ SPX & Duo Basket, Chrome, 1/Bag	BI	1	50	\$7.66
245-96520C01	Snap Post Replacement Basket For Ball-Lok™, Chrome, 1/Bag	BI	1	50	\$11.56
245-96540C01	Short Spring Post Replacement Basket For Big Boy™, Champion®, Specification™ & EezOn™, Chrome, 1/Bag	BI	1	50	\$7.11
245-99649C04	Junior Replacement Basket, Chrome, 1/Box	BI	1	10	\$7.32



245-96401C01



245-96520C01

Supply

Drainage

Support

Specialties

Appendix

Supply

Drainage

Support

Specialties

Appendix



290-20553C04



290-20515C04



290-20630C04



290-36302C01



290-20635C04

### Lav Sink Drains

Item Number	Item Description	Pkg Type	Min Qty	Case Qty	Price
<b>POP-UP</b>					
290-20553C04	Cast Brass Body w/ Overflow, 1-1/4" x 4" 20ga Tailpiece, Chrome, 1/Box	BI	1	50	\$36.16
<b>FIXED GRID</b>					
290-20514C04	1-1/4" x 8" w/ Overflow, Cast Brass Body w/ 17ga Tailpiece And Brass Nut, Chrome, 1/Box	BI	25	25	\$23.38
290-20515C04	Wheelchair Open Grid Strainer, Cast Brass Body w/ 17ga Offset Tailpiece, Overflow, Chrome, 1/Box	BI	1	25	\$43.88

### Lav Sink Drains

#### PO Plug Drain

Item Number	Item Description	Pkg Type	Min Qty	Case Qty	Price
<b>METAL - ONE-PIECE WITH OVERFLOW</b>					
290-20630C04	PO Plug Drain (w/ Overflow), 1-1/4" x 5", One Piece w/ Stopper And Chain, Chrome, 1/Box	BI	1	50	\$31.64
290-20632C04	PO Plug Drain (w/ Overflow), 1-1/4" x 8", One Piece w/ Stopper And Chain, Chrome, 1/Box	BI	1	50	\$30.26
<b>METAL TWO-PIECE WITH OVERFLOW</b>					
290-206322C04	PO Plug Drain (w/ Overflow), 1-1/4" x 8", Two Piece w/ Stopper And Chain, Chrome, 1/Box	BI	1	50	\$41.77
290-630223C04	PO Plug Drain (w/ Overflow), 1-1/4" x 5", Two Piece w/ Stopper And Chain, Chrome, 1/Box	BI	1	50	\$21.59
290-634223C04	PO Plug Drain (w/ Overflow), 1-1/4" x 12", Two Piece w/ Stopper And Chain, Chrome, 1/Box	BI	1	25	\$31.90
<b>PLASTIC ONE-PIECE WITH OVERFLOW</b>					
290-36302C01	PO Plug Drain (w/ Overflow), 1-1/4" x 5", Polypro w/ Stopper And Chain, Polished Stainless, 1/Bag	BI	1	25	\$8.99
290-3650501	PO Plug Drain (w/ Overflow), 1-1/4" x 5", ABS w/ Stopper And Chain, Polished Stainless, 1/Bag	BI	1	50	\$8.99

### Lav Sink Drains

#### CO Plug Drain

Item Number	Item Description	Pkg Type	Min Qty	Case Qty	Price
<b>METAL ONE-PIECE LESS OVERFLOW</b>					
290-20635C04	C.O. Plug Drain (Less Overflow), 1-1/4" x 5", One Piece w/ Stopper And Chain, Chrome, 1/Box	BI	1	50	\$32.68
<b>PLASTIC ONE-PIECE LESS OVERFLOW</b>					
290-36352C01	CO Plug Drain (Less Overflow), 1-1/4" x 5", Polypro w/ Stopper And Chain, Polished Stainless, 1/Bag	BI	1	25	\$8.99

**Lav Sink Drains**

**Industrial Sink Plug**

Item Number	Item Description	Pkg Type	Min Qty	Case Qty	Price
290-20200	Sink Plug 1", Rough Brass	BI	10	50	\$33.88



290-20200

Supply

Drainage

Support

Specialties

Appendix



# **Bath Waste Drains**

**Brass Waste & Overflows**

**Plastic Waste & Overflows**

**Accessories**





**973-2015C04**  
**Page 601**



**973-3102C04**  
**Page 601**



**973-3702C04**  
**Page 602**



**973-3900C04**  
**Page 602**



**973-0600C04**  
**Page 602**



**973-5401C04**  
**Page 603**



**973-6101C01**  
**Page 603**



**973-9000C01**  
**Page 604**



**Brass Waste & Overflows**

**Trip Lever**

Item Number	Item Description	Pkg Type	Min Qty	Case Qty	Price
973-2015C04	17ga w/ Brass Linkage & Drop Cylinder, Chrome, 1/Box	BI	1	10	\$109.00
973-3015C04	20ga w/ Brass Linkage & Drop Cylinder, Chrome, 1/Box	BI	1	16	\$74.43
973-3015PB04	20ga w/ Brass Linkage & Drop Cylinder, Polished Brass, 1/Box	BI	1	16	\$74.43
973-3015SN04	20ga w/ Brass Linkage & Drop Cylinder, Satin Nickel, 1/Box	BI	1	4	\$94.49
<b>ROMAN TUB WASTE &amp; OVERFLOW</b>					
973-3016C04	20ga w/ Brass Linkage & Drop Cylinder w/ 9" Shoe, Chrome, 1/Box	BI	1	3	\$116.88



**Brass Waste & Overflows**

**Ezy Touch®**

· Reemed Tee intended for above-the-floor applications

Item Number	Item Description	Pkg Type	Min Qty	Case Qty	Price
<b>EZY TOUCH®</b>					
973-2302C04	17ga, Brass Drain Spud & 2-Hole Faceplate, Chrome, 1/Box	BI	1	12	\$114.57
973-3302C04	20ga, Brass Drain Spud & 2-Hole Faceplate, Chrome, 1/Box	BI	1	12	\$90.72
<b>NYC INSTALLATION ABOVE OR BELOW FLOOR</b>					
973-2439C04	17ga, Brass Drain Spud & 2-Hole Faceplate, Chrome, 1/Box	BI	10	10	\$112.37



**Brass Waste & Overflows**

**Twist-N-Close™**

Item Number	Item Description	Pkg Type	Min Qty	Case Qty	Price
973-3102C04	20ga, Brass Drain Spud & 2-Hole Faceplate, Chrome, 1/Box	BI	4	16	\$93.58



Supply

Drainage

Support

Specialties

Appendix

Supply

Drainage

Support

Specialties

Appendix



973-3702C04

**Brass Waste & Overflows**

**Chain & Stopper**

Item Number	Item Description	Pkg Type	Min Qty	Case Qty	Price
973-3702C04	20ga, Chain, Stopper & 2-Hole Faceplate, Chrome, 1/Box	BI	1	3	\$66.52



973-3900C04

**Brass Waste & Overflows**

**Standing Waste**

Item Number	Item Description	Pkg Type	Min Qty	Case Qty	Price
973-3900C04	20ga, 1-1/2" FIP Connection, Chrome, 1/Box	BI	1	10	\$111.90



973-0600C04

**Plastic Waste & Overflows**

**Cable Drive**

Item Number	Item Description	Pkg Type	Min Qty	Case Qty	Price
<b>WHITE POLYPROPYLENE</b>					
973-0600C04	Tubular, Chrome Trim, 1/Box	BI	1	3	\$74.47
973-0600SN/RB04	Tubular, Includes Satin Nickel & Oil-Rubbed Bronze Trim, 1/Box	BI	1	3	\$118.02



973-0010C01



973-1010SN04

**Plastic Waste & Overflows**

**Trip Lever**

Item Number	Item Description	Pkg Type	Min Qty	Case Qty	Price
<b>WHITE POLY</b>					
973-0010C01	Tubular, Plastic Linkage & Drop Cylinder, Chrome, 1/Bag	BI	8	8	\$22.00
973-0010PB04	Plastic Linkage & Drop Cylinder, White, Polished Brass, 1/Box	BI	4	4	\$46.15
973-0010SN04	Plastic Linkage & Drop Cylinder, White, Satin Nickel, 1/Box	BI	4	4	\$46.15
973-0015C04	Tubular, Brass Linkage, Plastic Drop Cylinder & Chrome Trim, 1/Box	BI	8	8	\$27.27
973-0015RB04	Tubular, Brass Linkage, Plastic Drop Cylinder & Oil-Rubbed Bronze Trim, 1/Box	BI	1	8	\$52.79
<b>BLACK POLY</b>					
973-1010SN04	Tubular, Brass Linkage, Plastic Drop Cylinder & Satin Nickel Trim, 1/Box	BI	4	4	\$46.15

**Plastic Waste & Overflows**

**Ezy Touch®**

Item Number	Item Description	Pkg Type	Min Qty	Case Qty	Price
<b>WHITE POLY</b>					
973-0302C04	Tubular, Brass Drain Spud & 2-Hole Faceplate, Chrome, 1/Box	BI	1	8	\$31.00
973-0402C04	Tubular, Zinc Drain Spud & 2-Hole Faceplate, Chrome, 1/Bag	BI	8	8	\$28.63
<b>WITH PIPE &amp; TEE</b>					
973-6301C04	PVC Full Kit w/ Brass Drain Spud & 1-Hole Faceplate, Chrome, 1/Box	BI	8	8	\$33.06
973-8301C01	ABS Full Kit w/ Brass Drain Spud & 1-Hole Faceplate, Chrome, 1/Bag	BI	1	8	\$33.06
973-8301PB04	ABS Full Kit w/ Brass Drain Spud & 1-Hole Faceplate, Polished Brass, 1/Box	BI	4	4	\$64.89
<b>HALF KIT</b>					
973-5401C04	PVC w/ Zinc Drain Spud & 1-Hole Faceplate, Chrome, 1/Box	BI	1	12	\$22.23
973-7401C04	ABS w/ Zinc Drain Spud & 1-Hole Faceplate, Chrome, 1/Box	BI	1	12	\$26.77



973-5401C04

**Plastic Waste & Overflows**

**Twist-N-Close™**

Item Number	Item Description	Pkg Type	Min Qty	Case Qty	Price
<b>WHITE POLY</b>					
973-0102C04	Tubular, Brass Drain Spud & 2-Hole Faceplate, Chrome, 1/Box	BI	1	12	\$34.93
973-0202C04	Tubular, Zinc Drain Spud & 2-Hole Faceplate, Chrome, 1/Box	BI	8	8	\$26.36
<b>WITH PIPE &amp; TEE</b>					
973-6101C01	PVC Full Kit w/ Brass Drain Spud & 1-Hole Faceplate, Chrome, 1/Bag	BI	8	8	\$33.06
<b>HALF KIT</b>					
973-5201C01	PVC w/ Zinc Drain Spud & 1-Hole Faceplate, Chrome, 1/Bag	BI	8	8	\$22.23
973-5202C04	PVC w/ Zinc Drain Spud & 2-Hole Faceplate, Chrome, 1/Box	BI	8	8	\$23.34
973-7201C01	ABS w/ Zinc Drain Spud & 1-Hole Faceplate, Chrome, 1/Bag	BI	8	8	\$22.23



973-7201C01

Supply

Drainage

Support

Specialties

Appendix

**Bath Waste Accessories**

Item Number	Item Description	Pkg Type	Min Qty	Case Qty	Price
<b>OVERFLOW REPAIR</b>					
973-9000C01	Trip Lever Faceplate (Brass) With Screws, Chrome, 1/Bag	BI	1	25	\$19.41
973-9015R101	Brass Linkage For Trip Lever Waste & Overflow, 1/Bag	BI	6	120	\$6.55
974-60100	Trip Lever Faceplate (Zinc ) With Screws, Chrome, 1/Bag	BI	1	20	\$8.37
974-60101	Tub Faceplate w/ Screw, 1-Hole, Chrome, 1/Bag	BI	1	10	\$7.06
974-60102	Tub Faceplate w/ Screws, 2-Hole, Chrome, 1/Bag	BI	1	12	\$6.11
974-60116	Tub Overflow Sponge Gasket	B	12	120	\$1.51
<b>TUB WASTE REPAIR</b>					
973-9090C04	Heavy Gauge Bath Drain Spud w/ Grid Strainer, Chrome, 1/Bag	BI	1	1	\$20.62
973-9097C01	Brass Tub Shoe With 1-1/2" OD x 4-5/8" Tube & Chrome Strainer, 1/Bag	BI	1	20	\$37.41
973-9099C01	Bath Drain Grid Strainer Only w/ Screw, Chrome, 1/Bag	BI	1	20	\$2.54
<b>973-9100C04</b>	Twist-N-Close™ Drain Assembly In Heavy Gauge Brass Drain Spud, Chrome, 1/Box	BI	1	12	\$17.97
973-9300C04	Ezy Touch® Drain Assembly In Heavy Gauge Brass Drain Spud, Chrome, 1/Box	BI	1	12	\$17.97
973-9392C04	Ezy Touch® Replacement Stopper Assembly, Chrome, 1/Bag	BI	10	200	\$9.63
973-9601	Bathtub Drain Shoe Gasket, 1/Bag	BI	1	25	\$1.18



973-9000C01



973-9090C04



973-9601

Supply

Drainage

Support

Specialties

Appendix

# **Plumbing Specialties**

**Supply Stops & Kits**

**Supply Tubes**

**Lav/Sink Specialties**

**Closet Specialties**

**Tub/Shower Specialties**

# Plumbing Specialties

## Supply Stops & Kits

Straight and angle stop valves with quarter-turn and multi-turn designs. Select items designed in accordance with A112.18.1/CSA B125.1 - 2018 Standard for Plumbing Supply Fittings and ANSI/NSF 14.

## Supply Tubes

Flexible, water-supply connectors for sinks, toilets, dishwashers and other plumbing fixtures.

## Lav/Sink Specialties

Chrome-plated and plastic escutcheons, and other accessories.

## Closet Specialties

Closet bolts, gaskets and toilet repair items.

## Tub/Shower Specialties

Tub spouts, including the innovative SmartSpout™, shower arms and other accessories.

# Supply Stops & Kits

**Quarter-Turn Bar Stock**

**Quarter-Turn Forged Angle Stops**

**Quarter-Turn Forged Straight Stops**

**Multi-Turn Angle Stops**

**Multi-Turn Straight Stops**

**Add-A-Valve Fittings**

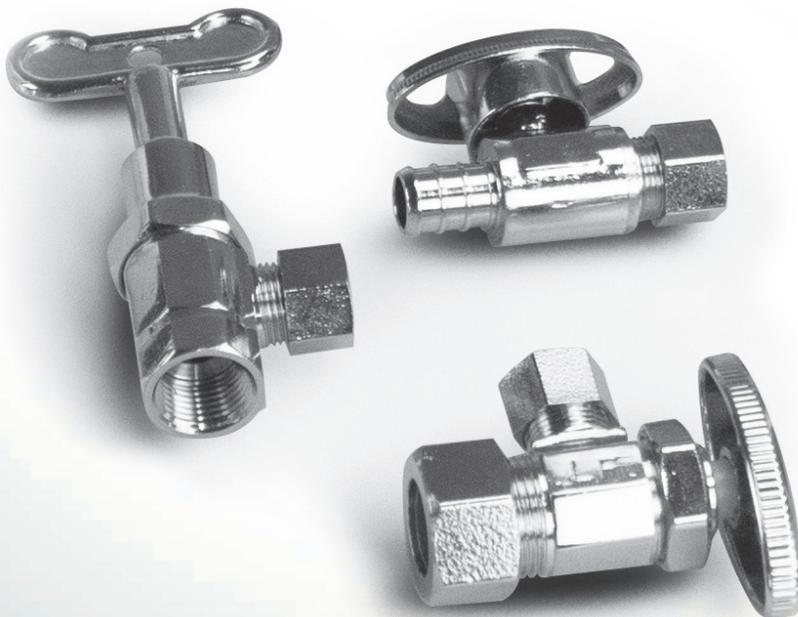



**130-G2C1C**  
Page 609



**129-G1RETRO**  
Page 609



**129-G2W1C**  
Page 609



**132-G2C0C04**  
Page 610



**132-G2C1C04**  
Page 610



**131-G2Q1C04**  
Page 611



**132-G2C1CLH04**  
Page 610



**131-G2X1C04**  
Page 611



**131-G0Y3HR101**  
Page 611



**134-G2C0C04**  
Page 612



**134-G2C1C1C04**  
Page 612



**134-G2C1C1CDH04**  
Page 612



**134-G2C1CLK04**  
Page 612



**134-G2S1CE5LK04**  
Page 612



**133-G2C1C1CDHR104**  
Page 613



**133-GZ2M2FR104**  
Page 613



**909-99100201**  
Page 613



**283-S04112C00**  
Page 617



**283-S06112C50**  
Page 617



**281-072**  
Page 618



**289-IMK04**  
Page 618



**637-B23HWP**  
Page 618



**290-20480**  
Page 618



Quarter-Turn Bar Stock

Item Number	Item Description	Pkg Type	Min Qty	Case Qty	Price
<b>ANGLE</b>					
130-G1F1C	3/8" FIP × 3/8" OD Comp., Chrome, 1/Bag	BI	24	144	\$11.90
130-G2C0C	5/8" OD Comp. × 1/4" OD Comp., Chrome, 1/Bag	BI	24	144	\$12.86
130-G2C1C	5/8" OD Comp. × 3/8" OD Comp., Chrome, 1/Bag	BI	24	144	\$10.29
130-G2F1C	1/2" FIP × 3/8" OD Comp., Chrome, 1/Bag	BI	24	144	\$11.90
130-G2S1C	1/2" (5/8" OD) SWT. × 3/8" OD Comp., Chrome, 1/Bag	BI	24	144	\$11.28
130-G2V1C	1/2" CPVC × 3/8" OD Comp., Chrome, 1/Bag	BI	24	144	\$13.89
130-G2W0C	1/2" PEX F1960 × 1/4" OD Comp., Chrome, 1/Bag	BI	24	144	\$14.70
130-G2W1C	1/2" PEX F1960 × 3/8" OD Comp., Chrome, 1/Bag	BI	24	144	\$13.01
130-G2X0C	1/2" PEX F1807 × 1/4" OD Comp., Chrome, 1/Bag	BI	24	144	\$12.86
130-G2X1C	1/2" PEX F1807 × 3/8" OD Comp., Chrome, 1/Bag	BI	24	144	\$9.72
<b>STRAIGHT</b>					
129-G1C1C	3/8" OD Comp. × 3/8" OD Comp., Chrome, 1/Bag	BI	24	144	\$13.08
129-G1F1C	3/8" FIP × 3/8" OD Comp., Chrome, 1/Bag	BI	24	144	\$11.90
129-G1RETRO	3/8" Swivel Comp. × 3/8" OD Comp., Chrome, 1/Bag	BI	24	144	\$13.41
129-G2C0C	5/8" OD Comp. × 1/4" OD Comp., Chrome, 1/Bag	BI	24	144	\$12.22
129-G2C1C	5/8" OD Comp. × 3/8" OD Comp., Chrome, 1/Bag	BI	24	144	\$10.11
129-G2F1C	1/2" FIP × 3/8" OD Comp., Chrome, 1/Bag	BI	24	144	\$11.90
129-G2S1C	1/2" SWT. × 3/8" OD Comp., Chrome, 1/Bag	BI	24	144	\$11.03
129-G2V1C	1/2" CPVC × 3/8" OD Comp., Chrome, 1/Bag	BI	24	144	\$13.95
129-G2W0C	1/2" PEX F1960 × 1/4" OD Comp., Chrome, 1/Bag	BI	24	144	\$15.15
129-G2W1C	1/2" PEX F1960 × 3/8" OD Comp., Chrome, 1/Bag	BI	24	144	\$13.05
129-G2X0C	1/2" PEX F1807 × 1/4" OD Comp., Chrome, 1/Bag	BI	24	144	\$12.47
129-G2X1C	1/2" PEX F1807 × 3/8" OD Comp., Chrome, 1/Bag	BI	24	144	\$9.99



130-G2C1C



130-G2W1C



129-G2C1C



129-G2W1C

Supply

Drainage

Support

Specialties

Appendix

Quarter-Turn Forged Angle Stops

KwikStop®

Item Number	Item Description	Pkg Type	Min Qty	Case Qty	Price
<b>STANDARD</b>					
132-G1F1C04	3/8" FIP × 3/8" OD Comp., Chrome, 1/Box	BI	20	240	\$10.92
132-G1Q1C04	3/8" PDQ (1/2" OD Push Fit) × 3/8" OD Comp., Chrome, 1/Box	BI	32	32	\$12.53
132-G2C0C04	5/8" OD Comp. × 1/4" OD Comp., Chrome, 1/Box	BI	20	240	\$13.99
132-G2C1C04	5/8" OD Comp. × 3/8" OD Comp., Chrome, 1/Box	BI	20	240	\$11.02
132-G2C1C09	5/8" OD Comp. × 3/8" OD Comp. w/ PEX Insert, Chrome, 1/Bag	BI	10	50	\$12.24
132-G2C1CN104	5/8" OD Comp. × 3/8" OD Comp. Less 3/8" Comp. Nut, Chrome, 1/Box	BI	20	240	\$10.47
132-G2C2M01	5/8" OD Comp. × 1/2" MIP (7/16" OD), Chrome, 1/Bag	BI	30	30	\$16.62
132-G2F0C01	1/2" FIP × 1/4" OD Comp., Chrome, 1/Bag	BI	30	30	\$13.56
132-G2F1C04	1/2" FIP × 3/8" OD Comp., Chrome, 1/Box	BI	20	240	\$12.24
132-G2F2C04	1/2" FIP × 1/2" OD Comp., Chrome, 1/Box	BI	20	240	\$17.49
132-G2Q1C04	1/2" PDQ (5/8" OD Push Fit) × 3/8" OD Comp., Chrome, 1/Box	BI	32	32	\$12.24
132-G2S1C04	1/2" SWT. × 3/8" OD Comp., Chrome, 1/Box	BI	20	240	\$11.60
132-G2S1CE504	1/2" SWT. × 3/8" OD Comp. w/ 5" Extension & Escutcheon, Chrome, 1/Box	BI	10	120	\$15.10
132-G2V1C04	1/2" CPVC × 3/8" OD Comp., Chrome, 1/Box	BI	20	120	\$14.36
132-G2X1C04	1/2" PEX F1807 × 3/8" OD Comp., Chrome, 1/Box	BI	5	30	\$10.47
<b>DUAL-OUTLET</b>					
132-G2C1C0C01	5/8" OD Comp. × 3/8" OD Comp. × 1/4" OD Comp., Chrome, 1/Bag	BI	5	30	\$17.05
132-G2C1C1C04	5/8" OD Comp. × 3/8" OD Comp. × 3/8" OD Comp., Chrome, 1/Box	BI	20	240	\$15.72
132-G2F1C0C01	1/2" FIP × 3/8" OD Comp. × 1/4" OD Comp., Chrome, 1/Bag	BI	5	30	\$16.62
132-G2F1C1C04	1/2" FIP × 3/8" OD Comp. × 3/8" OD Comp., Chrome, 1/Box	BI	20	240	\$16.62
<b>LOOSE HANDLE</b>					
132-G2C1CLH04	5/8" OD Comp. × 3/8" OD Comp., Chrome, 1/Box	BI	20	240	\$16.62

Supply

Drainage

Support

Specialties

Appendix



132-G2C0C04



132-G2F0C01



132-G2X1C04



132-G2C1CLH04

**Quarter-Turn Forged Straight Stops**

**KwikStop®**

Item Number	Item Description	Pkg Type	Min Qty	Case Qty	Price
131-GOY3HR101	1/4-Turn, 1/4" Swiv. Comp. X 3/4" MHT, Brass, 1/Bag	BI	5	60	\$9.29
131-G1F1C04	3/8" FIP x 3/8" OD Comp., Chrome, 1/Box	BI	20	240	\$11.37
131-G1Q1C04	3/8" PDQ (1/2" OD Push Fit) x 3/8" OD Comp., Chrome, 1/Box	BI	32	32	\$12.53
131-G2C1C04	5/8" OD Comp. x 3/8" OD Comp., Chrome, 1/Box	BI	20	240	\$10.72
131-G2C1C09	5/8" OD Comp. x 3/8" OD Comp. w/ PEX Insert, Chrome, 1/Box	BI	50	50	\$12.24
131-G2F1C04	1/2" FIP x 3/8" OD Comp., Chrome, 1/Box	BI	20	240	\$10.85
131-G2Q1C04	1/2" PDQ (5/8" OD Push Fit) x 3/8" OD Comp., Chrome, 1/Box	BI	32	32	\$12.24
131-G2S1C04	1/2" SWT. x 3/8" OD Comp., Chrome, 1/Box	BI	20	240	\$10.63
131-G2S1CE504	1/2" SWT. x 3/8" OD Comp. w/ 5" Extension & Escutcheon, Chrome, 1/Box	BI	10	120	\$15.10
131-G2V1C04	1/2" CPVC x 3/8" OD Comp., Chrome, 1/Box	BI	20	120	\$14.82
131-G2X1C04	1/2" PEX F1807 x 3/8" OD Comp., Chrome, 1/Box	BI	30	30	\$10.19
131-G2X2X04	1/2" PEX F1807 x 1/2" PEX F1807, Chrome, 1/Box	BI	20	240	\$10.47
131-GRETRO01	3/8" Swivel Comp. x 3/8" OD Comp., Chrome, 1/Bag	BI	30	30	\$14.52



131-G2C1C04



131-G2X1C04



131-GOY3HR101

Supply

Drainage

Support

Specialties

Appendix

Multi-Turn Angle Stops

Item Number	Item Description	Pkg Type	Min Qty	Case Qty	Price
<b>STANDARD</b>					
134-G1F1C04	3/8" FIP × 3/8" OD Comp., Chrome, 1/Box	BI	50	50	\$13.34
134-G2C0C04	5/8" OD Comp. × 1/4" OD Comp., Chrome, 1/Box	BI	50	50	\$13.34
134-G2C0CR104	5/8" OD Comp. × 1/4" OD Comp., Rough Brass, 1/Box	BI	50	50	\$13.11
134-G2C1C04	5/8" OD Comp. × 3/8" OD Comp., Chrome, 1/Box	BI	50	50	\$10.95
134-G2C1CE504	5/8" OD Comp. × 3/8" OD Comp. w/ 5" Extension & Escutcheon, Chrome, 1/Box	BI	1	50	\$15.60
134-G2C1CR104	5/8" OD Comp. × 3/8" OD Comp., Rough Brass, 1/Box	BI	50	50	\$10.77
134-G2C2C04	5/8" OD Comp. × 1/2" OD Comp., Chrome, 1/Box	BI	50	50	\$14.86
134-G2C2M04	5/8" OD Comp. × 1/2" MIP (7/16" OD), Chrome, 1/Box	BI	50	50	\$17.05
134-G2F1C04	1/2" FIP × 3/8" OD Comp., Chrome, 1/Box	BI	50	50	\$12.20
134-G2F2C04	1/2" FIP × 1/2" OD Comp., Chrome, 1/Box	BI	50	50	\$21.43
134-G2F2M04	1/2" FIP × 1/2" MIP & (7/16" OD), Chrome, 1/Box	BI	50	50	\$14.86
134-G2S0CR104	1/2" SWT. × 1/4" OD Comp., Rough Brass, 1/Box	BI	50	50	\$19.68
134-G2S1C04	1/2" SWT. × 3/8" OD Comp., Chrome, 1/Box	BI	50	50	\$10.63
134-G2S1CE504	1/2" SWT. × 3/8" OD Comp. w/ 5" Extension & Escutcheon, Chrome, 1/Box	BI	1	50	\$15.17
134-G2S1CR104	1/2" SWT. × 3/8" OD Comp., Rough Brass, 1/Box	BI	50	50	\$10.42
134-G2V1C04	1/2" CPVC × 3/8" OD Comp., Chrome, 1/Box	BI	50	50	\$14.02
134-G2V1CR104	1/2" CPVC × 3/8" OD Comp., Rough Brass, 1/Box	BI	50	50	\$13.81
134-G2X1C04	1/2" PEX F1807 × 3/8" OD Comp., Chrome, 1/Box	BI	50	50	\$9.74
648XG2FA	1/2" F1807 PEX × 3/8" OD Comp	B	5	60	\$10.74
<b>3-WAY</b>					
134-G2C1C1C04	5/8" OD Comp. × 3/8" OD Comp. × 3/8" OD Comp., Chrome, 1/Box	BI	1	30	\$17.44
134-G2C1C1CR104	5/8" OD Comp. × 3/8" OD Comp. × 3/8" OD Comp., Rough Brass, 1/Box	BI	1	30	\$17.20
134-G2F1C1C04	1/2" FIP × 3/8" OD Comp. × 3/8" OD Comp., Chrome, 1/Box	BI	1	30	\$13.99
134-G2F1C1CR104	1/2" FIP × 3/8" OD Comp. × 3/8" OD Comp., Rough Brass, 1/Box	BI	1	30	\$13.81
<b>2-HANDLE</b>					
134-G2C1C0CDHR104	5/8" OD Comp. × 3/8" OD Comp. × 1/4" OD Comp., Rough Brass, 1/Box	BI	1	50	\$26.57
134-G2C1C1CDH04	5/8" OD Comp. × 3/8" OD Comp. × 3/8" OD Comp., Chrome, 1/Box	BI	1	50	\$26.57
134-G2C1C1CDHR104	5/8" OD Comp. × 3/8" OD Comp. × 3/8" OD Comp., Rough Brass, 1/Box	BI	1	50	\$26.42
<b>LOOSE KEY</b>					
134-G2C1CLK04	5/8" OD × 3/8" OD Comp., Chrome, 1/Box	BI	1	50	\$15.79
134-G2F1CLK04	1/2" FIP × 3/8" OD Comp., Chrome, 1/Box	BI	1	50	\$16.37
134-G2F2CLK04	1/2" FIP × 1/2" OD Comp., Chrome, 1/Box	BI	1	50	\$34.38
134-G2S1CE5LK04	1/2" SWT. × 3/8" OD Comp. w/ 5" Extension & Escutcheon, Chrome, 1/Box	BI	1	50	\$21.43
134-G2S1CLK04	1/2" SWT. × 3/8" OD Comp., Chrome, 1/Box	BI	50	50	\$14.73



134-G2C0C04



134-G2X1C04



134-G2V1C04



134-G2C1C1C04



134-G2C1C1CDH04



134-G2C1CLK04

Supply

Drainage

Support

Specialties

Appendix

Multi-Turn Straight Stops

Item Number	Item Description	Pkg Type	Min Qty	Case Qty	Price
<b>STANDARD</b>					
133-G1F1C04	3/8" FIP x 3/8" OD Comp., Chrome, 1/Box	BI	50	50	\$13.81
133-G2C1C04	5/8" OD Comp. x 3/8" OD Comp., Chrome, 1/Box	BI	50	50	\$13.03
133-G2F1C04	1/2" FIP x 3/8" OD Comp., Chrome, 1/Box	BI	50	50	\$12.30
133-G2S1C04	1/2" SWT. x 3/8" OD Comp., Chrome, 1/Box	BI	50	50	\$12.92
133-G2S1CE504	1/2" SWT. x 3/8" OD Comp. w/ 5" Extension & Escutcheon, Chrome, 1/Box	BI	1	50	\$15.17
133-G2S1CR104	1/2" SWT. x 3/8" OD Comp., Rough Brass, 1/Box	BI	50	50	\$12.75
133-G2V1C04	1/2" CPVC x 3/8" OD Comp., Chrome, 1/Box	BI	50	50	\$16.18
133-G2V1CR104	1/2" CPVC x 3/8" OD Comp., Rough Brass, 1/Box	BI	50	50	\$16.01
133-G2X1C04	1/2" PEX F1807 x 3/8" OD Comp., Chrome, 1/Box	BI	50	50	\$10.81
<b>2-HANDLE</b>					
133-G2C1C1CDHR104	5/8" OD Comp. x 3/8" OD Comp. x 3/8" OD Comp., Rough Brass, 1/Box	BI	1	50	\$23.24
<b>INTEGRAL SLOT</b>					
133-GZ2M2FR104	1/2" MIP x 1/2" FIP w/ Slotted Stem, Rough Brass, 1/Box	BI	50	20	\$15.60
133-GZ2S2SR104	1/2" FSWT. x 1/2" MSWT. w/ Slotted Stem, Rough Brass, 1/Box	BI	50	50	\$11.80

Add-A-Valve Fitting

Item Number	Item Description	Pkg Type	Min Qty	Case Qty	Price
<b>STANDARD COMPRESSION</b>					
907-2120200201	1/2" Swivel Comp. x 1/2" OD Comp. x 1/4" OD Comp., Rough Brass, 1/Bag	BI	5	60	\$19.08
907-981001	3/8" Swivel Comp. x 3/8" OD Comp. x 3/8" OD Comp., Rough Brass, 1/Bag	BI	5	60	\$13.34
<b>ANDER-LIGN® COMPRESSION</b>					
909-991001	3/8" Swivel Comp. x 3/8" OD Comp. x 3/8" OD Comp., Rough Brass, 1/Bag	BI	5	60	\$11.29
909-99100201	3/8" Swivel Comp. x 3/8" OD Comp. x 1/4" OD Comp., Rough Brass, 1/Bag	BI	5	60	\$10.21



133-G2X1C04



133-G2C1C1CDHR104



133-GZ2M2FR104



907-981001



909-99100201

Supply

Drainage

Support

Specialties

Appendix



# Supply Tubes

**Lav/Sink Supply**

**Toilet Supply**

**Ice Maker Supply & Kits**

**Dishwasher Elbow Connectors**

**Washers & Gaskets**







Lav/Sink Supply

Item Number	Item Description	Pkg Type	Min Qty	Case Qty	Price
<b>COPPER</b>					
283-S04112C00	3/8" OD x 12", Chrome	B	25	100	\$4.90
283-S04112R100	3/8" OD x 12", Unplated	B	25	100	\$4.66
283-S04116C00	3/8" OD x 16", Chrome	B	25	100	\$6.56
283-S04120C00	3/8" OD x 20", Chrome	B	25	100	\$7.56
283-S04120R100	3/8" OD x 20", Unplated	B	25	100	\$7.14
283-S04130C50	3/8" OD x 30", Chrome	B	25	100	\$12.06
283-S04130R150	3/8" OD x 30", Unplated	B	25	100	\$11.47
283-S04136C50	3/8" OD x 36", Chrome	B	25	100	\$13.28
283-S04136R100	3/8" OD x 36", Unplated	B	25	100	\$11.76
<b>COPPER COMPRESSION TUBE EXTENSION</b>					
283-S06112C50	3/8" OD x 12" Comp. x Tube, Chrome	B	25	100	\$8.07
283-S06112R150	3/8" OD x 12" Comp. x Tube, Unplated	B	25	100	\$6.45
283-S06120C50	3/8" OD x 20" Comp. x Tube, Chrome	B	25	100	\$11.42
283-S06120R150	3/8" OD x 20" Comp. x Tube, Unplated	B	25	100	\$8.61
<b>COPPER SOLDER TUBE EXTENSION</b>					
283-S05112R150	3/8" OD x 12" MSWT x FSWT, Unplated	B	50	50	\$3.27
283-S05120R150	3/8" OD x 20" MSWT x FSWT, Unplated	B	50	50	\$5.19
<b>PEX</b>					
285-100	Ferrule, Poly 3/8" For PEX Riser	B	100	10000	\$0.18
285-S0412000	3/8" OD x 20" w/ Nylon Ferrule, PEX	B	100	100	\$1.31
285-S0413000	3/8" OD x 30" w/ Nylon Ferrule, PEX	B	100	100	\$1.79
285-S0413600	3/8" OD x 36" w/ Nylon Ferrule, PEX	B	100	100	\$2.05



283-S04112C00



283-S06112C50



283-S05112R150



285-S0412000

Toilet Supply

Item Number	Item Description	Pkg Type	Min Qty	Case Qty	Price
<b>COPPER</b>					
283-T24112C00	3/8" x 12" w/ Rubber Nose Cone, Chrome	B	25	100	\$7.42
283-T24120C00	3/8" x 20" w/ Rubber Nose Cone, Chrome	B	25	100	\$9.85
283-T25112C00	3/8" x 12" w/ Flat Washer, Chrome	B	25	100	\$6.29
283-T25116C00	3/8" x 16" w/ Flat Washer, Chrome	B	25	100	\$7.15
283-T25120C00	3/8" x 20" w/ Flat Washer, Chrome	B	25	100	\$8.59
<b>PEX</b>					
285-T2411200	3/8" OD x 12" w/ Nylon Ferrule, PEX	B	100	100	\$1.07
285-T2412000	3/8" OD x 20" w/ Nylon Ferrule, PEX	B	100	100	\$1.31
285-100	Ferrule, Poly 3/8" For PEX Riser	B	100	10000	\$0.18



283-T24112C00



285-T2411200

Supply

Drainage

Support

Specialties

Appendix

Supply

Drainage

Support

Specialties

Appendix



281-072



901-03020W00501



289-IMK04



637-B23HWP



290-20480

## Ice Maker Supply & Kits

### Related Products

Needle Valves - Saddle Valves p 746

Item Number	Item Description	Pkg Type	Min Qty	Case Qty	Price
<b>BRAIDED STAINLESS</b>					
281-072	Stainless Steel Connector 1/4" x 1/4" x 72", 1/Bag	BI	12	12	\$12.05
<b>POLYETHYLENE</b>					
901-03020W00251	1/4" OD x 17/100" ID (1/25" Wall) 25' Coil	CI	10	10	\$5.38
901-03020W00501	1/4" OD x 17/100" ID (1/25" Wall) 50' Coil	CI	5	5	\$9.84
901-03020W01001	1/4" OD x 17/100" ID (1/25" Wall) 100' Coil	BI	1	1	\$17.90
901-03020W01005	1/4" OD x 17/100" ID (1/25" Wall) 100' Reel	BI	1	1	\$17.90
901-03020W04005	1/4" OD X 17/100" ID (1/25" Wall), 400' Reel	BI	1	1	\$52.37
<b>PEX</b>					
289-IMK04	PEX Quick Connect Kit, 1/Bag	BI	5	5	\$38.92

## Dishwasher Supply & Kits

Item Number	Item Description	Pkg Type	Min Qty	Case Qty	Price
<b>DISHWASHER ELBOW CONNECTOR</b>					
637-B23HWP	3/4" Female Hose Thread x 3/8" OD Comp., Rough Brass, 1/Bag	BI	5	20	\$8.59
637-G23H	3/4" Female Hose Thread x 3/8" OD Comp., Short Radius, Heavy-Duty Hose Nut, Rough Brass, 1/Bag	B	20	20	\$7.49

## Washers & Gaskets

Item Number	Item Description	Pkg Type	Min Qty	Case Qty	Price
290-20480	Deluxe Lavatory Washer 3/8" Tall w/ Brass Friction Ring	B	50	500	\$0.91
291-30500	3/4" Garden Hose Washer	B	12	240	\$0.35

# **Lav/Sink Specialties**

**Poly Escutcheons**

**Metal Escutcheons**

**Sink/Faucet Repair**

**Dishwasher/Disposal Drain**

**Accessories**





**920-1W**  
Page 621



**926-2**  
Page 621



**910-2**  
Page 622



**923-2326C00**  
Page 622



**923-2322C00**  
Page 623



**923-1612C01**  
Page 623



**290-21104**  
Page 624



**291-30380**  
Page 624



**961-20155**  
Page 624



**242-10**  
Page 625



**905**  
Page 625



**902**  
Page 626



**249**  
Page 626



**290-20180**  
Page 627



**974-95650304**  
Page 627

**Polypropylene Escutcheons**

**TrimTite™ Escutcheons**

Item Number	Item Description	Pkg Type	Min Qty	Case Qty	Price
<b>SHALLOW CTS</b>					
920-1W	3/8" CTS (1/2" OD), White	B	50	500	\$0.16
920-2W	1/2" CTS (5/8" OD), White	B	25	250	\$0.22
920-2WPK2	1/2" CTS (5/8" OD), White, 2/Bag	Cl	10	10	\$0.95
920-3W	3/4" CTS (7/8" OD), White	B	25	250	\$0.24
920-3WPK2	3/4" CTS (7/8" OD), White, 2/Bag	Cl	10	10	\$0.99
920-4W	1" CTS (1-1/8" OD), White	B	20	100	\$0.51
920-4WPK2	1" CTS (1-1/8" OD), White, 2/Bag	Cl	1	1	\$1.52
<b>SHALLOW IPS</b>					
921-2W	1/2" IPS, White	B	50	500	\$0.24
921-2WPK2	1/2" IPS, White, 2/Bag	Cl	10	10	\$0.99
921-3W	3/4" IPS, White	B	50	500	\$0.26
921-3WPK2	3/4" IPS, White, 2/Bag	Cl	10	10	\$1.02
921-4W	1" IPS, White	B	20	100	\$0.47
921-4WPK2	1" IPS, White, 2/Bag	Cl	10	10	\$1.44
921-6W	1-1/2" IPS, White	B	20	100	\$0.45
921-6WPK2	1-1/2" IPS, White, 1/Bag	Cl	10	10	\$0.95
921-7W	2" IPS, White	B	20	100	\$0.47
921-7WPK2	2" IPS, White, 1/Bag	Cl	10	10	\$0.97
<b>DEEP TUBULAR</b>					
922-5W	1-1/4" OD Tubular, White	B	25	25	\$1.00
922-5WPK2	1-1/4" OD Tubular, White	Cl	10	10	\$1.50
922-6W	1-1/2" OD Tubular, White	B	25	25	\$1.00
922-6WPK2	1-1/2" OD Tubular, White	Cl	10	10	\$1.50

**Polypropylene Escutcheons**

**SnapOne™ Escutcheons**

Item Number	Item Description	Pkg Type	Min Qty	Case Qty	Price
<b>CTS</b>					
926-2	1/2" CTS (5/8" OD), Chrome, 1/Bag	Bl	12	120	\$1.38
926-2W	1/2" CTS (5/8" OD), White, 1/Bag	Bl	12	120	\$0.90
926-3	3/4" CTS (7/8" OD), Chrome, 1/Bag	Bl	12	120	\$1.41
926-3W	3/4" CTS (7/8" OD), White, 1/Bag	Bl	12	120	\$0.95
926-4	1" CTS (1-1/8" OD), Chrome, 1/Bag	Bl	12	120	\$1.53
926-4W	1" CTS (1-1/8" OD), White, 1/Bag	Bl	12	120	\$1.11



921-6W



922-5W



926-2

Supply

Drainage

Support

Specialties

Appendix

**Polypropylene Escutcheons (Cont)**

**SnapOne™ Escutcheons**



927-2W

Item Number	Item Description	Pkg Type	Min Qty	Case Qty	Price
<b>IPS</b>					
927-2	1/2" IPS, Chrome, 1/Bag	BI	12	120	\$1.38
927-2W	1/2" IPS , White, 1/Bag	BI	12	120	\$0.94
927-3	3/4" IPS, Chrome, 1/Bag	BI	12	120	\$1.51
927-3W	3/4" IPS , White, 1/Bag	BI	12	120	\$0.95
927-4	1" IPS, Chrome, 1/Bag	BI	12	120	\$1.61
927-4W	1" IPS , White, 1/Bag	BI	12	120	\$1.10
927-5	1-1/4" IPS, Chrome, 1/Bag	BI	12	120	\$2.19
927-6	1-1/2" IPS, Chrome, 1/Bag	BI	12	120	\$2.27
927-6W	1-1/2" IPS , White, 1/Bag	BI	12	120	\$1.31
927-7	2" IPS, Chrome, 1/Bag	BI	12	120	\$2.53
927-7W	2" IPS , White, 1/Bag	BI	12	120	\$1.30
927-8W	3" IPS , White, 1/Bag	BI	12	120	\$2.45

**Metal Escutcheons**

**Shallow Escutcheons**



910-2

Item Number	Item Description	Pkg Type	Min Qty	Case Qty	Price
<b>SHALLOW CTS</b>					
910-2	1/2" CTS (5/8" OD), Chrome	BI	25	250	\$0.60
910-3	3/4" CTS (7/8" OD), Chrome	BI	25	250	\$0.63
<b>SHALLOW IPS</b>					
911-1	3/8" IPS, Chrome	BI	25	250	\$0.70
911-2	1/2" IPS, Chrome	BI	25	250	\$0.60
911-3	3/4" IPS, Chrome	BI	25	250	\$0.72
911-4	1" IPS, Chrome	BI	25	250	\$0.83
911-6	1-1/2" IPS, Chrome	BI	25	250	\$0.99
911-6D	1-1/2" IPS Deluxe, Chrome, 1/Bag	BI	25	250	\$1.36
911-7	2" IPS, Chrome	BI	25	250	\$1.66
<b>SHALLOW TUBULAR</b>					
923-1036C00	1-1/2" OD Tubular, Chrome	BI	12	120	\$0.77



911-4



923-1036C00

**Metal Escutcheons**

**Deep Box**



923-2326C00

Item Number	Item Description	Pkg Type	Min Qty	Case Qty	Price
<b>IPS</b>					
923-2326C00	1-1/2" IPS, Chrome	BI	5	100	\$2.72

Supply

Drainage

Support

Specialties

Appendix

## Metal Escutcheons (Cont)

### Deep Box

Item Number	Item Description	Pkg Type	Min Qty	Case Qty	Price
<b>TUBULAR</b>					
923-2335C00	1-1/4" OD Tubular, Chrome	BI	5	100	\$2.49
923-2336C00	1-1/2" OD Tubular, Chrome	BI	5	100	\$2.13



923-2335C00

## Metal Escutcheons

### Deep Bell

Item Number	Item Description	Pkg Type	Min Qty	Case Qty	Price
<b>IPS</b>					
923-2321C00	3/8" IPS, Chrome	BI	25	100	\$2.82
923-2322C00	1/2" IPS, Chrome	BI	25	100	\$3.66
<b>TUBULAR</b>					
923-2435C00	1-1/4" OD Tubular x 3" Base, Chrome	BI	25	25	\$2.49
923-2436C00	1-1/2" OD Tubular x 3" Base, Chrome	BI	25	25	\$2.72
<b>CAST BRASS - IPS</b>					
923-2521C04	3/8" IPS, Cast Brass w/ Set Screw, Chrome, 1/Bag	BI	1	200	\$8.84
923-2522C04	1/2" IPS, Cast Brass w/ Set Screw, Chrome, 1/Bag	BI	1	200	\$9.62
923-2525C04	1-1/4" IPS, Cast Brass w/ Set Screw, Chrome, 1/Bag	BI	1	200	\$13.44
923-2526C04	1-1/2" IPS, Cast Brass w/ Set Screw, Chrome, 1/Bag	BI	1	200	\$14.27
923-2527C04	2" IPS, Cast Brass w/ Set Screw, Chrome, 1/Bag	BI	1	200	\$16.39
<b>CAST BRASS - TUBULAR</b>					
923-2536C04	1-1/2" OD Tubular, Cast Brass w/ Set Screw, Chrome, 1/Bag	BI	1	200	\$14.27



923-2322C00



923-2435C00



923-2522C04

## Metal Escutcheons

### Hinged Floor & Ceiling Plates

Item Number	Item Description	Pkg Type	Min Qty	Case Qty	Price
<b>CTS</b>					
923-1612C01	1/2" CTS (5/8" OD), Chrome, 1/Bag	BI	12	12	\$2.12
923-1613C01	3/4" CTS (7/8" OD), Chrome, 1/Bag	BI	12	12	\$2.44
923-1614C01	1" CTS (1-1/8" OD), Chrome, 1/Bag	BI	12	120	\$2.49
923-1615C01	1-1/4" CTS (1-3/8" OD), Chrome, 1/Bag	BI	12	12	\$2.83
923-1616C01	1-1/2" CTS (1-5/8" OD), Chrome, 1/Bag	BI	12	12	\$2.83



923-1612C01

Supply

Drainage

Support

Specialties

Appendix

Supply

Drainage

Support

Specialties

Appendix



923-1625C01

## Metal Escutcheons (Cont)

### Hinged Floor & Ceiling Plates

Item Number	Item Description	Pkg Type	Min Qty	Case Qty	Price
<b>IPS</b>					
923-1622C01	1/2" IPS, Chrome, 1/Bag	BI	12	12	\$2.05
923-1623C01	3/4" IPS, Chrome, 1/Bag	BI	12	12	\$2.77
923-1624C01	1" IPS, Chrome, 1/Bag	BI	12	12	\$2.27
923-1625C01	1-1/4" IPS, Chrome, 1/Bag	BI	12	12	\$2.83
923-1626C01	1-1/2" IPS, Chrome, 1/Bag	BI	12	12	\$2.32
923-1627C01	2" IPS, Chrome, 1/Bag	BI	12	12	\$3.32



290-21104

## Sink/Faucet Repair

### Faucet Aerators

· 2.2 GPM maximum

Item Number	Item Description	Pkg Type	Min Qty	Case Qty	Price
290-21100	Dual 15/16"-27 Thread Male x 55/64"-27 Thread Female, Non-Slotted, Chrome	BI	48	48	\$3.52
290-21104	Small 13/16"-27 Thread Male, Non-Slotted, Chrome	BI	48	48	\$3.75
290-21110	Aerator Adapter - Dual 15/16"-27 Thread Male x 55/64"-27 Thread Female x 3/4" MHT, Chrome	BI	5	250	\$6.10



291-30380

## Sink/Faucet Repair

### O-Rings

Item Number	Item Description	Pkg Type	Min Qty	Case Qty	Price
291-30380	Buna-N O-Rings, 150-Piece Kit	BI	10	10	\$37.07



961-20155

## Sink/Faucet Repair

### Faucet Hole Covers

Item Number	Item Description	Pkg Type	Min Qty	Case Qty	Price
961-20155	Plastic, 1-3/4" w/ O-Ring And Wing Nut , White	BI	1	25	\$3.89
961-6	Metal, 1-3/4" w/ Toggle Nut, Chrome	B	25	25	\$2.23
961-7	Metal, 2" w/ Wing Nut, Chrome	B	25	25	\$2.76



## Sink/Faucet Repair

### NoPutty™ Gaskets

**Related Products**

Basket Strainers and Sink Drains p 593

Item Number	Item Description	Pkg Type	Min Qty	Case Qty	Price
<b>KITCHEN SINK &amp; SHOWER DRAIN</b>					
290-20320	4-1/4" OD × 3-3/8" ID	B	100	1000	\$1.49
290-20320PK2	4-1/4" OD × 3-3/8" ID, 4/Bag	Cl	12	12	\$6.71
<b>LAVATORY DRAINS &amp; KITCHEN HOSE SPRAY</b>					
290-20322	2" OD × 1-1/2" ID	B	100	1000	\$1.15
290-20322PK2	2" OD × 1-1/2" ID, 4/Bag	Cl	12	12	\$5.35
<b>BATHTUB &amp; BAR SINK</b>					
290-20324	2-3/4" OD × 2" ID	B	100	1000	\$1.15
290-20324PK2	2-3/4" OD × 2" ID, 4/Bag	Cl	12	12	\$5.35



290-20320

## Sink/Faucet Repair

### Kitchen Hose Spray

Item Number	Item Description	Pkg Type	Min Qty	Case Qty	Price
242-10	Spray Head & Hose Kit w/ Universal Connection, Black, 1/Bag	Bl	10	10	\$16.65
242-20	Hose Guide, Plastic w/ Polished Stainless Steel Skirt, Black, 1/Bag	Bl	25	100	\$2.72
242-20102	Spray Head & Hose Kit w/ Universal Connection, White, 1/Bag	Bl	10	10	\$18.50
242-20116	Hose Guide, Plastic w/ Polished Stainless Steel Skirt, White, 1/Bag	Bl	25	25	\$3.68
242-25	Universal Spray Head Only, Black, 1/Bag	Bl	10	10	\$8.82



242-10

## Dishwasher/Disposal Drain

### Drain Hose

- EPDM hose has maximum operating temperature of 225°F
- Vinyl hose has maximum operating temperature of 185°F

Item Number	Item Description	Pkg Type	Min Qty	Case Qty	Price
<b>EPDM HOSE</b>					
900-12256N00101	5/8" ID × 7/8" OD (1/8" Wall) Black 10' Coil	Bl	5	5	\$21.25
905	Dishwasher Drain Hose 5/8" ID × 50' Coil, EZ Dispenser Box (Unit of Measure Per Box)	B	1	1	\$108.62
905-PK	Dishwasher Drain Hose 5/8" ID × 50' Coil, EZ Dispenser Box (Unit of Measure Per Foot)	B	50	50	\$2.22
906	Dishwasher Drain Hose 7/8" ID × 50' Coil, EZ Dispenser Box (Unit of Measure Per Box)	B	1	1	\$182.86
906-PK	Dishwasher Drain Hose 7/8" ID × 50' Coil, EZ Dispenser Box (Unit of Measure Per Foot)	B	50	50	\$3.71



905

Supply

Drainage

Support

Specialties

Appendix

Supply



900-04258N00505

Drainage

## Dishwasher/Disposal Drain (Cont)

### Drain Hose

Item Number	Item Description	Pkg Type	Min Qty	Case Qty	Price
<b>BRAIDED VINYL HOSE</b>					
900-04258N00101	Dishwasher Drain Hose 5/8" × 1" OD (3/16" Wall), 10' Coil	BI	10	10	\$22.40
900-04258N00505	Dishwasher Drain Hose 5/8" × 1" OD (3/16" Wall), 50' Reel	BI	1	1	\$93.30
900-04338N00021	7/8" ID × 1-1/4" OD (3/16" Wall) × 2'	BI	12	12	\$5.98
900-04338N00101	Dishwasher Drain Hose 7/8" ID × 1-1/4" OD (3/16" Wall), × 10' Coil	BI	5	5	\$29.86

Support



IMG\_0273

## Dishwasher/Disposal Drain

### Dishwasher Adapter

Item Number	Item Description	Pkg Type	Min Qty	Case Qty	Price
902	Black Elastomer Universal Adapter w/ 2 Stainless Worm Clamps, Bagged	BI	50	50	\$4.26
90201	Universal Dishwasher/Disposal Connector w/ 4 Clamps, Bagged	B	1	100	\$3.15

Specialties

## Dishwasher/Disposal Drain

### Dishwasher Air Gaps

Item Number	Item Description	Pkg Type	Min Qty	Case Qty	Price
249	Heavy-Duty Air Gap w/ Brass Cap, 1/2" Inlet And 3/4" Outlet, Chrome, 1/Bag	BI	25	50	\$12.77
249-20135	Economy Air Gap w/ Poly Cap, 1/2" Inlet And 3/4" Outlet, Chrome, 1/Box	BI	50	50	\$6.28

Appendix



249

## Dishwasher/Disposal Drain

### Auto Vent

- For secondary venting only. Each drainage system must have a main vent stack
- To be installed in a readily accesible location with free flow of air, never in a sealed wall cavity.
- Sealing disc of auto vent must be located at least 6" above the top of the trap arm.



239

Item Number	Item Description	Pkg Type	Min Qty	Case Qty	Price
239	Trap Vent ABS 1-1/2" MPT	B	50	50	\$3.80
239PK2	Trap Vent ABS 1-1/2" MPT, 1/Bag	CI	10	10	\$4.55

**Dishwasher/Disposal Drain**

**Disposal Drain**

Item Number	Item Description	Pkg Type	Min Qty	Case Qty	Price
290-20180	Replacement In-Sink-Erator Disposal Elbow Gasket Only	B	5	25	\$0.93
290-20185	1-1/2" x 7" Disposal Waste Elbow, 1/Bag	BI	12	12	\$4.17



290-20180

**Lav/Sink Accessories**

**Lavatory Legs**

Item Number	Item Description	Pkg Type	Min Qty	Case Qty	Price
974-95650004	Lavatory (China Or Iron) Basin Legs, Chrome, 2/Box	BI	1	12	\$48.76
974-95650304	Lavatory (China Only) Basin Legs, Chrome, 2/Box	BI	1	12	\$47.14



974-95650304

Supply

Drainage

Support

Specialties

Appendix



# Closet Specialties

**Closet Bolts**

**Bolt Caps**

**Wedgelt™**

**Closet Bowl Gaskets**

**Tank-to-Bowl Repair**

**Toilet Fill Valves**

**Toilet Flush Valves**

**Tank Handles**

**Miscellaneous**



The PlumbPerfect™ is the original nylon closet bolt - and is Made in the USA.  
Beware of look-alikes, the PlumbPerfect has a tensile strength of over 1,100 lbs. per bolt.



**416-PB**  
Page 631



**425**  
Page 631



**440-2W**  
Page 631



**460-10**  
Page 632



**402-10**  
Page 632



**490-10555**  
Page 633



**490-1080M2KIT**  
Page 633



**490-10465**  
Page 633



**490-11100**  
Page 634



**490-10700**  
Page 635



**490-10108**  
Page 636

**Closet Bolts**

**Solid Brass Bolts**

Item Number	Item Description	Pkg Type	Min Qty	Case Qty	Price
410-PB	1/4" × 2-1/4", 2/Bag	BI	50	50	\$2.52
411-PB	1/4" × 3-1/2", 2/Bag	BI	50	50	\$3.34
415-PB	5/16" × 1-3/4", 2/Bag	BI	50	50	\$3.27
416-PB	5/16" × 2-1/4", 2/Bag	BI	50	50	\$3.90
417	1/4"-20", 7/16" Hex Nut, Nickel-Plated Steel	B	100	1000	\$0.18
418	5/16"-18", 9/16" Hex Nut, Nickel-Plated Steel	BI	100	1000	\$0.31
419	5/16" Washer, Nickel-Plated Steel	B	100	5000	\$0.20
<b>SNAPIT™ SOLID BRASS BOLTS</b>					
412-PB	1/4" × 2-1/4" With Captive Washer, 2/Bag	BI	50	50	\$3.01
414-PB	5/16" × 2-1/4" With Captive Washer, 2/Bag	BI	50	50	\$4.31



410-PB



412-PB

**PlumbPerfect™**

**Glass-Filled Nylon**

Item Number	Item Description	Pkg Type	Min Qty	Case Qty	Price
425	2-1/2" Bolts w/ Open Nut, Bulk Box	B	100	100	\$0.58
425-PB	2-1/2" Bolts w/ Open Nut, 2/Bag	BI	50	50	\$1.22
427	3-1/2" Bolts w/ Open Nut, Bulk	B	100	100	\$0.68
427-PB	3-1/2" Bolts w/ Open Nut, 2/Bag	BI	50	50	\$1.40



425

**SmartCap™**

**Bolt Caps**

Item Number	Item Description	Pkg Type	Min Qty	Case Qty	Price
<b>WHITE</b>					
440-2W	Cap w/ 425-PB Bolts, 2/Bag	CI	25	25	\$3.40
442-2W	Cap Only, 2/Bag	CI	25	25	\$2.28
<b>BONE</b>					
442-2B	Cap Only, 2/Bag	CI	25	25	\$2.63



440-2W



442-2B

**Closet Bolt Cover Cap**

Item Number	Item Description	Pkg Type	Min Qty	Case Qty	Price
490-11240	Economy Cap, White, 2/Bag	BI	25	500	\$1.61



490-11240

Supply

Drainage

Support

Specialties

Appendix

Supply



460-10

Drainage



460-11310

Support



402-10

Specialties



402-427

Appendix



490-10540



490-10545

## Wedgelt™

### Closet Shims

Item Number	Item Description	Pkg Type	Min Qty	Case Qty	Price
<b>STIFF POLYPROPYLENE</b>					
460-10	Closet Wedge, Bulk	B	100	1000	\$0.29
460-10J	Closet Wedge, 10/Bag, 20 Bar-Coded Bags In A Dispenser Box	BI	1	1	\$69.91
460-11300	Closet Wedge, 10/Bag	B	10	10	\$3.75
<b>SOFT PVC</b>					
460-11310	Closet Wedge, 10/Bag	B	10	10	\$4.76
460-20	Closet Wedge, Bulk	B	100	1000	\$0.44
460-20J	Closet Wedge, 10/Bag, 20 Bar-Coded Bags In A Dispenser Box	BI	1	1	\$89.19

## Closet Bowl Gaskets

### Wax

Item Number	Item Description	Pkg Type	Min Qty	Case Qty	Price
<b>GASKET ONLY</b>					
402-10	Gasket w/ Poly Flange, 1/Box	B	24	24	\$3.53
<b>GASKET KITS</b>					
402-410	(1) Gasket With Poly Flange, (2) 410-PB 1/4" × 2-1/4" Solid Brass Bolts & (2) 460-20 Soft PVC Wedges, 1/Kit	BI	24	24	\$6.12
402-427	(1) Gasket With Poly Flange, (2) 427-PB PlumbPerfect™ 3-1/2" Bolts, 1/Kit	BI	24	24	\$5.93
402-440	(1) Gasket With Poly Flange, (2) 425-PB PlumbPerfect™ 2-1/2" Bolts & (2) Smart Caps, 1/Kit	BI	24	24	\$9.14

## Closet Bowl Gaskets

### Waxless Foam

Item Number	Item Description	Pkg Type	Min Qty	Case Qty	Price
490-10540	5-3/8" OD × 3-3/8" ID × 9/16" High, Sponge Rubber	B	10	10	\$8.28
490-10541	5-1/4" OD × 3-7/16" ID × 1/2" High, Sponge Rubber	B	10	10	\$6.99
490-10542	5-3/8" OD × 3-1/2" ID × 3/4" High, Sponge Rubber	B	10	10	\$8.19
490-10543	5-5/8" OD × 3-1/2" ID × 1" High, Sponge Rubber	B	10	10	\$9.60
<b>WITH CLOSET BOLT HOLES</b>					
490-10545	6-3/4" OD × 3-1/2" ID × 3/8" High, Sponge Rubber	B	10	10	\$7.52
490-10546	6-3/4" OD × 3-1/2" ID × 9/16" High, Sponge Rubber	B	10	10	\$9.33
490-10547	6-3/4" OD × 3-1/2" ID × 3/4" High, Sponge Rubber	B	10	10	\$10.37
490-10548	6-3/4" OD × 3-1/2" ID × 1" High, Sponge Rubber	B	10	10	\$13.92



**Tank-To-Bowl Repair**

Item Number	Item Description	Pkg Type	Min Qty	Case Qty	Price
<b>BOLTS</b>					
452-PB	23/32" Head, 2/Bag	BI	50	50	\$6.61
490-10500	Deluxe w/ 7/8" Head, 2/Bag	BI	1	50	\$10.17
<b>KITS</b>					
490-10555	Universal Kit Includes Gasket And 2 Bolts, 1/Bag	BI	25	25	\$9.57
490-10560	American Standard Kit Includes Gasket And 2 Bolts, 1/Bag	BI	25	25	\$10.05
490-10565	Gerber Kit Includes Gasket And 2 Bolts, 1/Bag	BI	25	25	\$9.57
490-10570	Kohler Kit Includes Gasket And 3 Bolts, 1/Bag	BI	25	25	\$13.31
490-10572	Kohler Kit Includes Sponge Rubber Gasket And 3 Bolts, 1/Bag	BI	25	25	\$13.40
490-10575	Eljer Kit Includes Gasket And 2 Bolts, 1/Bag	BI	25	25	\$9.57
490-10585	Mansfield Kit Includes Gasket And 3 Bolts, 1/Bag	BI	25	25	\$13.61
<b>GASKETS</b>					
490-10656	Universal	BI	25	25	\$1.68
490-10661	American Standard	BI	25	25	\$2.09
490-10666	Gerber	BI	25	25	\$2.27
490-10673	Kohler Green	BI	25	25	\$1.68
490-10676	Eljer	BI	25	25	\$2.24



452-PB



490-10555



490-10661

**Toilet Tank Fill Valves**

**Governor™**

Item Number	Item Description	Pkg Type	Min Qty	Case Qty	Price
490-1080M2KIT	Governor 80M2 Adjustable Toilet Fill Valve & Flapper Kit, 1/Clamshell	BI	1	5	\$46.27



490-1080M2KIT

**Toilet Tank Fill Valves**

**Anti-Siphon**

Item Number	Item Description	Pkg Type	Min Qty	Case Qty	Price
490-10465	8-1/2" Hoov-R-Line Replacement	BI	12	12	\$17.99



490-10465

**Toilet Tank Flush Valves**

Item Number	Item Description	Pkg Type	Min Qty	Case Qty	Price
<b>FLUSH VALVES</b>					
490-11150	8" w/ Flapper	BI	12	12	\$10.41
490-11151	10" w/ Flapper	BI	12	12	\$10.75



490-11150

Supply

Drainage

Support

Specialties

Appendix

Supply

Drainage

Support

Specialties

Appendix

### Toilet Tank Flush Valves (Cont)

Item Number	Item Description	Pkg Type	Min Qty	Case Qty	Price
<b>ACCESSORIES</b>					
490-11152	Universal Gasket Only For Flush Valve	BI	25	25	\$3.58

### ELJER Touch Flush KIT

Item Number	Item Description	Pkg Type	Min Qty	Case Qty	Price
490-10325	Eljer Touch Flush Tank Ball And Handle Set	BI	12	12	\$12.18



490-10325

### Tank Handles

Item Number	Item Description	Pkg Type	Min Qty	Case Qty	Price
490-11100	Universal Metal Handle w/ Die Cast Nut & Cushion Washer, Chrome, 1/Bag	BI	25	25	\$5.66
490-11120	Deluxe Metal Handle w/ Brass Nut & Cushion Washer, Chrome, 1/Bag	BI	15	15	\$11.78
490-11140	Mansfield ABS, Chrome, 1/Bag	BI	12	12	\$8.65
490-11157	American Standard ABS Neo Mount, Chrome, 1/Bag	BI	12	12	\$8.22
490-11159	Eljer Side Mount w/ Brass Arm, Chrome, 1/Bag	BI	12	12	\$11.01



490-11100

### Ringer™

#### Stainless Steel Repair Ring

Item Number	Item Description	Pkg Type	Min Qty	Case Qty	Price
886-MR	Stnls Steel Closet Ring	CI	20	20	\$8.24



886-MR

#### Two-Piece Repair Ring

#### Galvanized Steel Repair Ring

Item Number	Item Description	Pkg Type	Min Qty	Case Qty	Price
886-MRM	Two-Piece Flange Repair Ring Kit, 1/Card	CI	8	8	\$24.67



886-MRM

**Raise-A-Ring™**

**Closet Flange Extension Ring**

Item Number	Item Description	Pkg Type	Min Qty	Case Qty	Price
886-411	Raise-A-Ring Kit: One 886-R Ring w/ Closet Bolts And Two Shims, Bagged	CI	20	20	\$7.16
886-R	7/16" Thick Flange Extension Ring, Carded	CI	20	20	\$4.49
886-RQ	1/4" Thick Flange Extension Ring	CI	20	20	\$3.12
886-RQK	Raise-A-Ring Kit: Three 886-Rq Rings w/ Closet Bolts, Bagged	BI	25	25	\$10.53



886-411

**QuickSpacer™**

**Closet Flange Spacer Ring**

Item Number	Item Description	Pkg Type	Min Qty	Case Qty	Price
886-ER	3/4" Closet Flange Spacer Ring	BI	25	25	\$2.89



886-ER

**Save-A-Flange™**

**Broken Flange Repair Kit**

Item Number	Item Description	Pkg Type	Min Qty	Case Qty	Price
490-11320	Closet Flange Repair Kit	BI	1	10	\$7.76



490-11320

**Closet Flange Floor Support**

**Galvanized Steel Support Plates**

Item Number	Item Description	Pkg Type	Min Qty	Case Qty	Price
490-11322	Floor Flange Support For Closet Flange, 1/Bag	CI	1	10	\$24.31

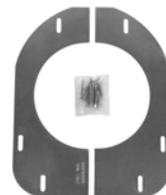

490-11322

**Misc Closet Repair**

Item Number	Item Description	Pkg Type	Min Qty	Case Qty	Price
<b>SLOAN VACUUM BREAKER</b>					
490-10700	Sloan Vacuum Breaker Kit	BI	12	12	\$3.02



490-10700

Supply

Drainage

Support

Specialties

Appendix

Misc Closet Repair (Cont)

Item Number	Item Description	Pkg Type	Min Qty	Case Qty	Price
<b>FLAPPERS</b>					
490-10108	Blue Vinyl Chemical Resistant Flapper w/ 9" Stainless Steel Chain And Hook	BI	25	25	\$5.18
490-10110	Clear Vinyl Chemical Resistant 3-Way Flapper w/ 9" Stainless Steel Chain And Hook	BI	25	25	\$4.84
490-10112	Clear Vinyl Chemical Resistant 1.6 GPF Flapper w/ 4 Orifices, 9" Stainless Steel Chain And Hook	BI	25	25	\$8.74
490-10115	Kohler Round Replacement Flapper w/ 8" Stainless Steel Chain And Hook For 1 Pc. Toilets	BI	25	25	\$6.55
490-10117	Kohler Rialto One-Piece Replacement Flapper	BI	25	25	\$6.87
490-10120	ABS Flapper w/ TPR Seal, Replaces Kohler, American Standard And Coast.	BI	25	25	\$6.40
490-10121	ABS New Style 1.6 GPF Flapper w/ TPR Seal, Replaces Kohler And Coast.	BI	25	25	\$7.41
490-10122	TPR Seal Only For 490-10120 Flapper, 1/Bag	BI	25	25	\$1.43
<b>REPLACEMENT PARTS</b>					
490-10206	Replacement 3" Tank Ball For Douglas Flush Valve	BI	25	25	\$4.97
490-10211	Replacement Tank Ball For Eljer Touch-Flush	BI	1	50	\$3.32
490-10302	American Standard Flush Valve Disc, Snap-On	BI	25	25	\$5.66
490-10312	American Standard Flush Valve Disc, Screw-On	BI	25	25	\$5.44
490-10320	American Standard Flush Valve Seal	BI	1	50	\$2.41
490-10340	Mansfield Old Style Flush Valve Gasket	BI	25	25	\$5.29
490-10341	Mansfield New Style Flush Valve Gasket	BI	25	25	\$2.75
490-10451	Float Ball Poly Bulk	BI	24	24	\$1.94



490-10108



490-10206

Supply

Drainage

Support

Specialties

Appendix

# Tub/Shower Specialties

**Tub Spouts**

**DrySeal™ Pipe Collar**

**Shower WallNut™**

**Shower Arms**

**Shower Heads**

**Add-A-Shower**



The innovative SmartSpout™ tightens flush to the finished wall - No Gap!  
The patented design installs over copper tube and uses an internal mechanism  
to pull itself tightly to the wall so no caulking is needed.



**972-36**  
**Page 639**



**972-100**  
**Page 639**



**616-02C**  
**Page 640**



**974-60306**  
**Page 640**



**974-60300**  
**Page 641**



**974-68200301**  
**Page 641**

**Tub Spouts**

**SmartSpout™**

Item Number	Item Description	Pkg Type	Min Qty	Case Qty	Price
<b>WITH DIVERTER</b>					
972-36	5/8" OD Slip Connect, Chrome, 1/Box	Bl	1	18	\$39.43
972-361PK2	5/8" OD Slip Connect & Adapter Kit, Chrome, 1/Clamshell	Bl	6	6	\$47.43
972-362PK2	5/8" OD Slip Connect & Adapter Kit, Satin Nickel, 1/Clamshell	Bl	6	6	\$55.43
972-363PK2	5/8" OD Slip Connect & Adapter Kit, Oil-Rubbed Bronze, 1/Clamshell	Bl	6	6	\$56.93
972-36RB	5/8" OD Slip Connect, Oil-Rubbed Bronze, 1/Box	Bl	1	18	\$47.81
972-36SN	5/8" OD Slip Connect, Satin Nickel, 1/Box	Bl	1	18	\$47.81
<b>NON-DIVERTER</b>					
972-32	5/8" OD Slip Connect, Chrome, 1/Box	Bl	1	18	\$35.46
972-32RB	5/8" OD Slip Connect, Oil-Rubbed Bronze, 1/Box	Bl	1	18	\$41.88
972-32SN	5/8" OD Slip Connect, Satin Nickel, 1/Box	Bl	1	18	\$41.88
<b>REPAIR ADAPTER</b>					
972-3RA	1/2" CTS Extension Only, 5/Bag	B	1	10	\$13.23



972-36



972-32RB



972-3RAKIT

**Tub Spouts**

**Standard**

Item Number	Item Description	Pkg Type	Min Qty	Case Qty	Price
<b>WITH DIVERTER</b>					
972-15	1/2" FIP At Nose, Chrome, 1/Box	B	1	50	\$22.93
972-35	5/8" OD Slip Connect w/ 1-3/8" Adjustment, Chrome, 1/Box	B	1	50	\$29.58
<b>NON-DIVERTER</b>					
972-10	1/2" FIP At Nose, Chrome, 1/Box	B	1	50	\$12.45
972-20	3/4" FIP Connection At Nose (w/ 3/4"X 1/2" Bushing), Chrome, 1/Box	B	1	50	\$12.88
972-30	5/8" OD Slip Connect w/ 1-3/8" Adjustment, Chrome, 1/Box	B	1	50	\$23.15
<b>ACCESSORIES</b>					
972-100	Brass Escutcheon w/ Foam Gasket, Chrome, 1/Bag	Bl	1	12	\$14.43



972-35



972-10



972-100

Supply

Drainage

Support

Specialties

Appendix

Supply



928-2

### DrySeal™ Pipe Collar

Item Number	Item Description	Pkg Type	Min Qty	Case Qty	Price
<b>CTS</b>					
928-2	1/2" CTS	B	50	500	\$0.27
<b>IPS</b>					
928-12	1/2" IPS	B	50	500	\$0.27

Drainage

Support



616-02C

### Shower WallNut™

- Warning: the Shower WallNut™ system MUST be installed using a copper stub out and #525-16WLB bracket for warranty coverage.
- DO NOT use thread sealant or P.T.F.E. tape on Shower WallNut™ end of shower arm

#### Related Products

Shower WallNut™ LockBlock™ p 520



307-625

Item Number	Item Description	Pkg Type	Min Qty	Case Qty	Price
<b>SHOWER ARM ADAPTER</b>					
616-02BM	Shower Arm Adapter, Matte Black, 1/Bag	BI	1	25	\$24.65
616-02C	Shower Arm Adapter, Chrome, 1/Bag	BI	25	25	\$9.17
616-02RB	Shower Arm Adapter, Oil-Rubbed Brnz, 1/Bag	BI	1	25	\$26.37
616-02SN	Shower Arm Adapter, Satin Nickel, 1/Bag	BI	1	25	\$26.37
<b>TOOLS</b>					
307-616	Shower WallNut Removal Tool	BI	1	10	\$39.08
307-625	Shower Arm Installation Tool	BI	6	6	\$11.06

Appendix



974-60306

### Shower Arms & Escutcheons

Item Number	Item Description	Pkg Type	Min Qty	Case Qty	Price
974-60306	6" Brass Shower Arm, Chrome	BI	1	25	\$10.68
974-60308	8" Brass Shower Arm, Chrome	BI	1	25	\$12.29
<b>"S" ARM</b>					
974-60315	10" Brass S-Pattern Shower Arm, Chrome	BI	1	10	\$38.88



974-60315



**Shower Heads**

Item Number	Item Description	Pkg Type	Min Qty	Case Qty	Price
974-60300	Showerhead Replacement 1-3/4" Face w/ Adjustable Spray, Chrome, 1/Box	Bl	1	6	\$50.29



974-60300

**Add-A-Shower**

**Add-A-Shower**

Item Number	Item Description	Pkg Type	Min Qty	Case Qty	Price
<b>BATH COCK TYPE</b>					
974-68100304	Bath Cock Type Add-On Shower Assembly Kit, Chrome, 1/Box	Bl	1	1	\$204.97
974-68200301	Bath Cock Type Add-On Shower Assembly Kit w/ Curtain Ring, Chrome, 1/Box	Bl	1	4	\$280.91
974-686003C04	Diverter, Bath Cock Only, Chrome, 1/Box	Bl	1	24	\$108.57
<b>SPOUT TYPE</b>					
974-68000304	Spout Type Add-On Shower Assembly Kit, Chrome, 1/Box	Bl	1	1	\$133.85



974-68200301



974-68000304

**Add-A-Shower**

**Add-A-Rod**

Item Number	Item Description	Pkg Type	Min Qty	Case Qty	Price
974-660303L04	5' Polished Aluminum Shower Rod Less Flanges	B	50	50	\$8.37
974-662303L04	6' Polished Aluminum Shower Rod Less Flanges	B	50	50	\$10.18
974-6633032H04	Corner Shower Rod w/ Support & Flanges, Polished Aluminum, 1/Box	Bl	1	1	\$67.51
974-668303BH	D-Shaped Shower Rod w/ Support & Flanges, Polished Aluminum, 1/Box	Bl	1	1	\$75.87
<b>ACCESSORIES</b>					
974-84410301	Shower Rod Ceiling Flange Only, Chrome, 1/Bag	Bl	1	50	\$12.05
974-85033201	Jiffy Adjustable Shower Rod Flange, ABS, Chrome, 2/Bag	Bl	1	100	\$2.32



974-668303BH



974-85020300

Supply

Drainage

Support

Specialties

Appendix



# **Tubing & Hose**

**Vinyl Tubing**

**Polyethylene Tubing**

**Hose**

**Fuel Line**

**Gasket Material**

# Tubing & Hose

## Vinyl Tubing

Clear and black vinyl tubing is flexible and easy to connect for a variety of applications. Braided options available for higher-pressures. Not for use as dishwasher or ice maker supply.

## Polyethylene Tubing

Flexible polyethylene tubing can be used for dishwasher or ice maker supply, as well as other fixtures/appliances.

## Hose

A variety of supply and drain hoses in assorted materials and sizes for various applications.

## Fuel Line

Flexible tubing for fuel lines in small engines and motors.

## Gasket Material

Sheet material designed for cutting custom replacement gaskets and other flat seals.

# Vinyl Tubing

**Clear Vinyl Tubing**

**Black Vinyl Tubing**





## Clear Vinyl Tubing

### Clear Standard Tubing

· Do NOT use with ice makers or dishwashers



900-01023C01005

Item Number	Item Description	Pkg Type	Min Qty	Case Qty	Price
<b>1/8" I.D.</b>					
900-01021C04005	1/8" ID x 3/16" OD (1/32" Wall) 400' EZ Dispenser	BI	1	1	\$45.84
900-01023C01005	1/8" ID x 1/4" OD (1/16" Wall) 100' Reel	BI	1	1	\$20.39
<b>17/100" I.D.</b>					
900-01030C00101	17/100" ID x 1/4" OD (1/2"5" Wall) 10' Coil	CI	10	10	\$2.42
900-01030C00201	17/100" ID x 1/4" OD (1/2"5" Wall) 20' Coil	CI	10	10	\$4.16
900-01030C04005	17/100" ID x 1/4" OD (1/2"5" Wall) 400' Reel	BI	1	1	\$62.40
<b>3/16" I.D.</b>					
900-01053C00101	3/16" ID x 5/16" OD (1/16" Wall) 10' Coil	CI	10	10	\$3.35
900-01053C00201	3/16" ID x 5/16" OD (1/16" Wall) 20' Coil	CI	10	10	\$5.74
900-01053C03005	3/16" ID x 5/16" OD (1/16" Wall) 300' Reel	BI	1	1	\$64.67
<b>1/4" I.D.</b>					
900-01103C00101	1/4" ID x 3/8" OD (1/16" Wall) 10' Coil	CI	10	10	\$3.90
900-01103C00201	1/4" ID x 3/8" OD (1/16" Wall) 20' Coil	CI	10	10	\$6.68
900-01103C00501	1/4" ID x 3/8" OD (1/16" Wall) 50' Coil	CI	2	2	\$15.28
900-01103C01005	1/4" ID x 3/8" OD (1/16" Wall) 100' Reel	BI	1	1	\$27.09
900-01103C02505	1/4" ID x 3/8" OD (1/16" Wall) 250' Reel	BI	1	1	\$62.51
<b>5/16" I.D.</b>					
900-01153C00101	5/16" ID x 7/16" OD (1/16" Wall) 10' Coil	CI	10	10	\$4.72
900-01153C00201	5/16" ID x 7/16" OD (1/16" Wall) 20' Coil	CI	10	10	\$8.08
900-01153C02005	5/16" ID x 7/16" OD (1/16" Wall) 200' EZ Dispenser	BI	1	1	\$67.29
<b>3/8" I.D.</b>					
900-01163C00101	3/8" ID x 1/2" OD (1/16" Wall) 10' Coil	CI	10	10	\$5.22
900-01163C00201	3/8" ID x 1/2" OD (1/16" Wall) 20' Coil	CI	10	10	\$8.94
900-01163C00501	3/8" ID x 1/2" OD (1/16" Wall) 50' Coil	BI	1	1	\$20.47
900-01163C01005	3/8" ID x 1/2" OD (1/16" Wall) 100' Reel	BI	1	1	\$37.22
900-01164C01005	3/8" ID x 9/16" OD (3/32" Wall) 100' EZ Dispenser	BI	1	1	\$56.07
<b>1/2" I.D.</b>					
900-01203C00101	1/2" ID x 5/8" OD (1/16" Wall) 10' Coil	CI	10	10	\$6.09
900-01203C00201	1/2" ID x 5/8" OD (1/16" Wall) 20' Coil	CI	10	10	\$10.42
900-01203C00501	1/2" ID x 5/8" OD (1/16" Wall) 50' Coil	BI	1	1	\$23.89
900-01203C01005	1/2" ID x 5/8" OD (1/16" Wall) 100' Reel	BI	1	1	\$43.44
900-01206C00101	1/2" ID x 3/4" OD (1/8" Wall) 10' Coil	CI	10	10	\$12.00
900-01206C01005	1/2" ID x 3/4" OD (1/8" Wall) 100' Reel	BI	1	1	\$85.64
<b>5/8" I.D.</b>					
900-01253C00101	5/8" ID x 3/4" OD (1/16" Wall) 10' Coil	CI	10	10	\$7.82
900-01253C00201	5/8" ID x 3/4" OD (1/16" Wall) 20' Coil	CI	5	5	\$13.38
900-01253C01005	5/8" ID x 3/4" OD (1/16" Wall) 100' EZ Dispenser	BI	1	1	\$55.81
900-01256C00101	5/8" ID x 7/8" OD (1/8" Wall) 10' Coil	CI	5	5	\$14.57
900-01256C01005	5/8" ID x 7/8" OD (1/8" Wall) 100' Reel	BI	1	1	\$103.99
<b>3/4" I.D.</b>					
900-01306C00101	3/4" ID x 1" OD (1/8" Wall) 10' Coil	CI	10	10	\$16.77
900-01306C00201	3/4" ID x 1" OD (1/8" Wall) 20' Coil	CI	5	5	\$28.74
900-01306C00755	3/4" ID x 1" OD (1/8" Wall) 75' Reel	BI	1	1	\$98.84

Supply

Drainage

Support

Specialties

Appendix

## Clear Vinyl Tubing (Cont)

### Clear Standard Tubing

Item Number	Item Description	Pkg Type	Min Qty	Case Qty	Price
<b>1" I.D.</b>					
900-01406C00021	1" ID × 1-1/4" OD (1/8" Wall) 2' Length	CI	5	5	\$4.28
900-01406C00101	1" ID × 1-1/4" OD (1/8" Wall) 10' Coil	CI	5	5	\$21.40
900-01406C00505	1" ID × 1-1/4" OD (1/8" Wall) 50' Reel	BI	1	1	\$84.12
900-01406C01005	1" ID × 1-1/4" OD (1/8" Wall) 100' Reel	BI	1	1	\$152.92
<b>1-1/4" I.D.</b>					
900-01508C00255	1-1/4" ID × 1-5/8" OD (3/16" Wall) 25' Reel	BI	1	1	\$82.57
900-01508C00504	1-1/4" ID × 1-5/8" OD (3/16" Wall) 50' Reel	BI	1	1	\$151.40
<b>1-1/2" I.D.</b>					
900-01608C00505	1-1/2" ID × 1-7/8" OD (3/16" Wall) 50' Reel	BI	1	1	\$172.26

## Clear Vinyl Tubing

### Clear Braided



900-02106C00101

Item Number	Item Description	Pkg Type	Min Qty	Case Qty	Price
<b>1/4" I.D.</b>					
900-02106C00101	1/4" ID × 1/2" OD (1/8" Wall) 10' Coil	CI	10	10	\$8.86
900-02106C02505	1/4" ID × 1/2" OD (1/8" Wall) 250' Reel	BI	1	1	\$142.22
<b>3/8" I.D.</b>					
900-02166C00101	3/8" ID × 5/8" OD (1/8" Wall) 10' Coil	CI	10	10	\$10.53
900-02166C01505	3/8" ID × 5/8" OD (1/8" Wall) 150' Reel	BI	1	1	\$112.88
<b>1/2" I.D.</b>					
900-02206C00101	1/2" ID × 3/4" OD (1/8" Wall) 10' Coil	CI	10	10	\$13.21
900-02206C01005	1/2" ID × 3/4" OD (1/8" Wall) 100' Reel	BI	1	1	\$94.33
<b>5/8" I.D.</b>					
900-02256C00101	5/8" ID × 7/8" OD (1/8" Wall) 10' Coil	CI	10	10	\$14.74
900-02256C00755	5/8" ID × 7/8" OD (1/8" Wall) 75' Reel	BI	1	1	\$86.83
<b>3/4" I.D.</b>					
900-02306C00101	3/4" ID × 1" OD (1/8" Wall) 10' Coil	CI	10	10	\$17.56
900-02306C00755	3/4" ID × 1" OD (1/8" Wall) 75' Reel	BI	1	1	\$103.48
<b>1" I.D.</b>					
900-02408C00101	1" ID × 1-3/8" OD (3/16" Wall) 10' Coil	CI	5	5	\$33.24
900-02408C00505	1" ID × 1-3/8" OD (3/16" Wall) 50' Reel	BI	1	1	\$130.62
<b>1-1/4" I.D.</b>					
900-02509C00021	1-1/4" ID × 1-3/4" OD (1/4" Wall) 2' Length	CI	5	5	\$11.65
900-02509C00505	1-1/4" ID × 1-3/4" OD (1/4" Wall) 50' Reel	BI	1	1	\$228.88
<b>1-1/2" I.D.</b>					
900-02609C00021	1-1/2" ID × 2" OD (1/4" Wall) 2' Length	CI	5	5	\$13.98
900-02609C00505	1-1/2" ID × 2" OD (1/4" Wall) 50' Reel	BI	1	1	\$274.77

Supply

Drainage

Support

Specialties

Appendix



**Black Vinyl Tubing**

Item Number	Item Description	Pkg Type	Min Qty	Case Qty	Price
	<b>3/8" I.D.</b>				
900-01163N00101	3/8" ID × 1/2" OD (1/16" Wall) 10' Coil	Cl	5	5	\$5.22
	<b>1/2" I.D.</b>				
900-01203N00101	1/2" ID × 5/8" OD (1/16" Wall) 10' Coil	Cl	5	5	\$6.09
	<b>3/4" I.D.</b>				
900-01306N00101	3/4" ID × 1" OD (1/8" Wall) 10' Coil	Cl	5	5	\$16.77



900-01163N00101

Supply

Drainage

Support

Specialties

Appendix



# **Polyethylene Tubing**

**Low-Density Polyethylene Tubing**



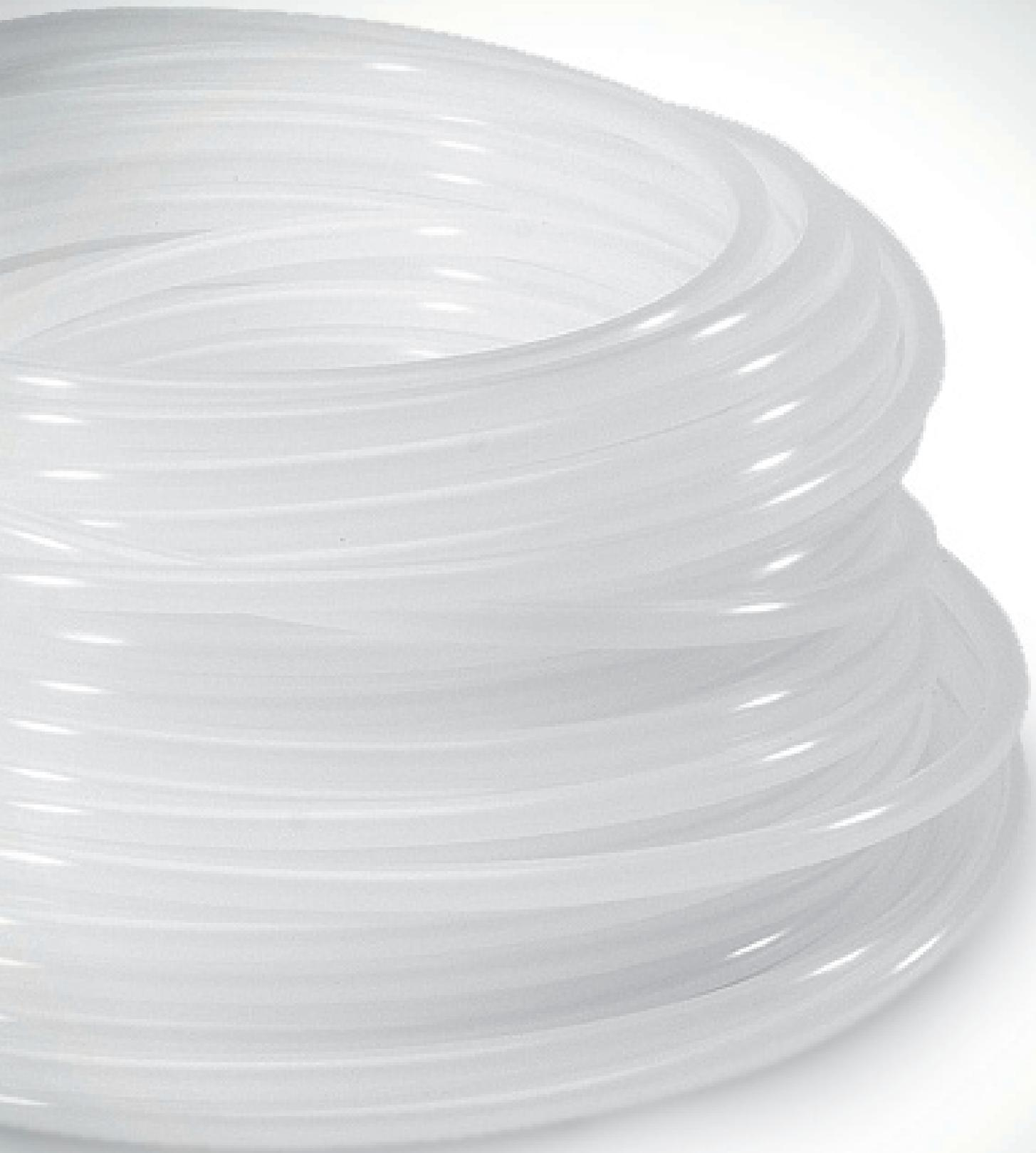

**Low-Density Polyethylene Tubing**



901-03020W00251

Item Number	Item Description	Pkg Type	Min Qty	Case Qty	Price
<b>1/4" O.D.</b>					
901-03020W00251	1/4" OD x 17/100" ID (1/25" Wall) 25' Coil	Cl	10	10	\$5.38
901-03020W00501	1/4" OD x 17/100" ID (1/25" Wall) 50' Coil	Cl	5	5	\$9.84
901-03020W01001	1/4" OD x 17/100" ID (1/25" Wall) 100' Coil	Bl	1	1	\$17.90
901-03020W01005	1/4" OD x 17/100" ID (1/25" Wall) 100' Reel	Bl	1	1	\$17.90
901-03020W04005	1/4" OD X 17/100" ID (1/25" Wall), 400' Reel	Bl	1	1	\$52.37
<b>5/16" O.D.</b>					
901-03053W00101	5/16" OD x 3/16" ID (1/16" Wall) 10' Coil	Cl	5	5	\$3.90
901-03053W03005	5/16" OD x 3/16" ID (1/16" Wall) 300' EZ Dispenser	Cl	1	1	\$74.55
<b>3/8" O.D.</b>					
901-03103W00251	3/8" x OD x 1/4" ID (1/16" Wall) 25' Coil	Cl	10	10	\$9.35
901-03103W01005	3/8" OD x 1/4" ID (1/16" Wall) 100' Reel	Bl	1	1	\$31.18
901-03103W03005	3/8" OD x 1/4" ID (1/16" Wall) 300' EZ Dispenser	Bl	1	1	\$79.27
<b>1/2" O.D.</b>					
901-03163W00251	1/2" OD x 3/8" ID (1/16" Wall) 25' Coil	Cl	5	5	\$11.56
901-03163W01005	1/2" OD x 3/8" ID (1/16" Wall) 100' Reel	Bl	1	1	\$38.54
901-03163W02005	1/2" OD x 3/8" ID (1/16" Wall) 200' Reel	Bl	1	1	\$73.70

Supply

Drainage

Support

Specialties

Appendix



# Hose

**Washer/Disposal Hose**

**Garden Hose**

**Heater/Utility Hose**

**Flexible PVC Spa Hose**

**Suction/Discharge Hose**

**Latex Hose**







## Dishwasher/Disposal Drain

### Drain Hose

- EPDM = Maximum operating temperature 225°F
- Braided Vinyl = Maximum operating temperature 185°F

Item Number	Item Description	Pkg Type	Min Qty	Case Qty	Price
<b>EPDM HOSE</b>					
900-12256N00101	5/8" ID × 7/8" OD (1/8" Wall) Black 10' Coil	BI	5	5	\$21.25
905	Dishwasher Drain Hose 5/8" ID × 50' Coil, EZ Dispenser Box (Unit of Measure Per Box)	B	1	1	\$108.62
905-PK	Dishwasher Drain Hose 5/8" ID × 50' Coil, EZ Dispenser Box (Unit of Measure Per Box)	B	50	50	\$2.22
906	Dishwasher Drain Hose 7/8" ID × 50' Coil, EZ Dispenser Box (Unit of Measure Per Foot)	B	1	1	\$182.86
906-PK	Dishwasher Drain Hose 7/8" ID × 50' Coil, EZ Dispenser Box (Unit of Measure Per Foot)	B	50	50	\$3.71
<b>BRAIDED VINYL HOSE</b>					
900-04258N00101	Dishwasher Drain Hose 5/8" × 1" OD (3/16" Wall), 10' Coil	BI	10	10	\$22.40
900-04258N00505	Dishwasher Drain Hose 5/8" × 1" OD (3/16" Wall), 50' Reel	BI	1	1	\$93.30
900-04338N00021	7/8" ID × 1-1/4" OD (3/16" Wall) × 2'	BI	12	12	\$5.98
900-04338N00101	Dishwasher Drain Hose 7/8" ID × 1-1/4" OD (3/16" Wall), × 10' Coil	BI	5	5	\$29.86



900-04258N00101



900-04338N00255

## Heater Hose

Item Number	Item Description	Pkg Type	Min Qty	Case Qty	Price
<b>EPDM HOSE</b>					
900-12306N00101	3/4" ID × 1" OD (1/8" Wall) Black 10' Coil	BI	5	5	\$29.02



900-12256N00101

## Garden Hose

Item Number	Item Description	Pkg Type	Min Qty	Case Qty	Price
900-07256G01505	5/8" ID × 7/8" OD (1/8" Wall) Green 150' Reel	BI	1	1	\$174.00

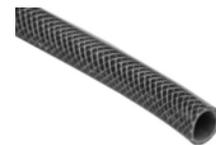

900-07256G01505

Supply

Drainage

Support

Specialties

Appendix

Supply



900-16300W00021

Drainage

Support

Specialties

Appendix



900-18300W00061



900-19600B00251



900-06103Y00101

### Flexible PVC Spa Hose

Item Number	Item Description	Pkg Type	Min Qty	Case Qty	Price
900-16200W01004	1/2" ID x 100' Reel, White	BI	1	1	\$175.41
900-16300W00021	3/4" ID x 2' Stick, White	CI	1	5	\$6.34
900-16300W00101	3/4" ID x 10' Coil, White	BI	1	1	\$31.74
900-16300W01004	3/4" ID x 100' Coil, White	BI	1	1	\$226.69
900-16400W00021	1" ID x 2' Stick, White	CI	1	5	\$7.56
900-16400W00101	1" ID x 10' Coil, White	BI	1	1	\$37.78
900-16400W00504	1" ID x 50' Coil, White	BI	1	1	\$144.81
900-16500W00021	1-1/4" ID x 2' Stick, White	CI	1	5	\$9.70
900-16500W00101	1-1/4" ID x 10' Coil, White	BI	1	1	\$48.49
900-16500W00504	1-1/4" ID x 50' Coil, White	BI	1	1	\$190.50
900-16600W00021	1-1/2" ID x 2' Stick, White	CI	1	5	\$9.91
900-16600W00101	1-1/2" ID x 10' Coil, White	BI	1	1	\$49.57
900-16600W00504	1-1/2" ID x 50' Coil, White	BI	1	1	\$194.73
900-16700W00021	2" ID x 2' Stick, White	CI	1	5	\$15.44
900-16700W00101	2" ID x 10' Coil, White	BI	1	1	\$77.20
900-16700W00254	2" ID x 25' Coil, White	BI	1	1	\$193.00

### Suction/Discharge Hose

Item Number	Item Description	Pkg Type	Min Qty	Case Qty	Price
<b>PUMP &amp; BILGE HOSE</b>					
900-18300W00061	3/4" ID x 6' Coil, White	CI	3	3	\$10.17
900-18430W00061	1-1/8" ID x 6' Coil, White	CI	3	3	\$11.78
<b>FLAT DISCHARGE HOSE (NON-REINFORCED)</b>					
900-19600B00251	1-1/2" ID x 25' Coil, Blue	CI	5	5	\$19.16
900-19600B00501	1-1/2" ID x 50' Coil, Blue	CI	5	5	\$35.10
900-19700B00251	2" ID x 25' Coil, Blue	CI	5	5	\$34.18
900-19700B00501	2" ID x 50' Coil, Blue	CI	5	5	\$62.65

### Latex Hose

Item Number	Item Description	Pkg Type	Min Qty	Case Qty	Price
900-06103Y00101	1/4" ID x 3/8" OD (1/16 Wall) Yellow 10' Coil	CI	5	5	\$20.44
900-06103Y00505	1/4" ID x 3/8" OD (1/16 Wall) Yellow 50' Reel	BI	1	1	\$85.16

# Fuel Line

Polyurethane Micro Fuel Line

Polyester Reinforced Fuel Line



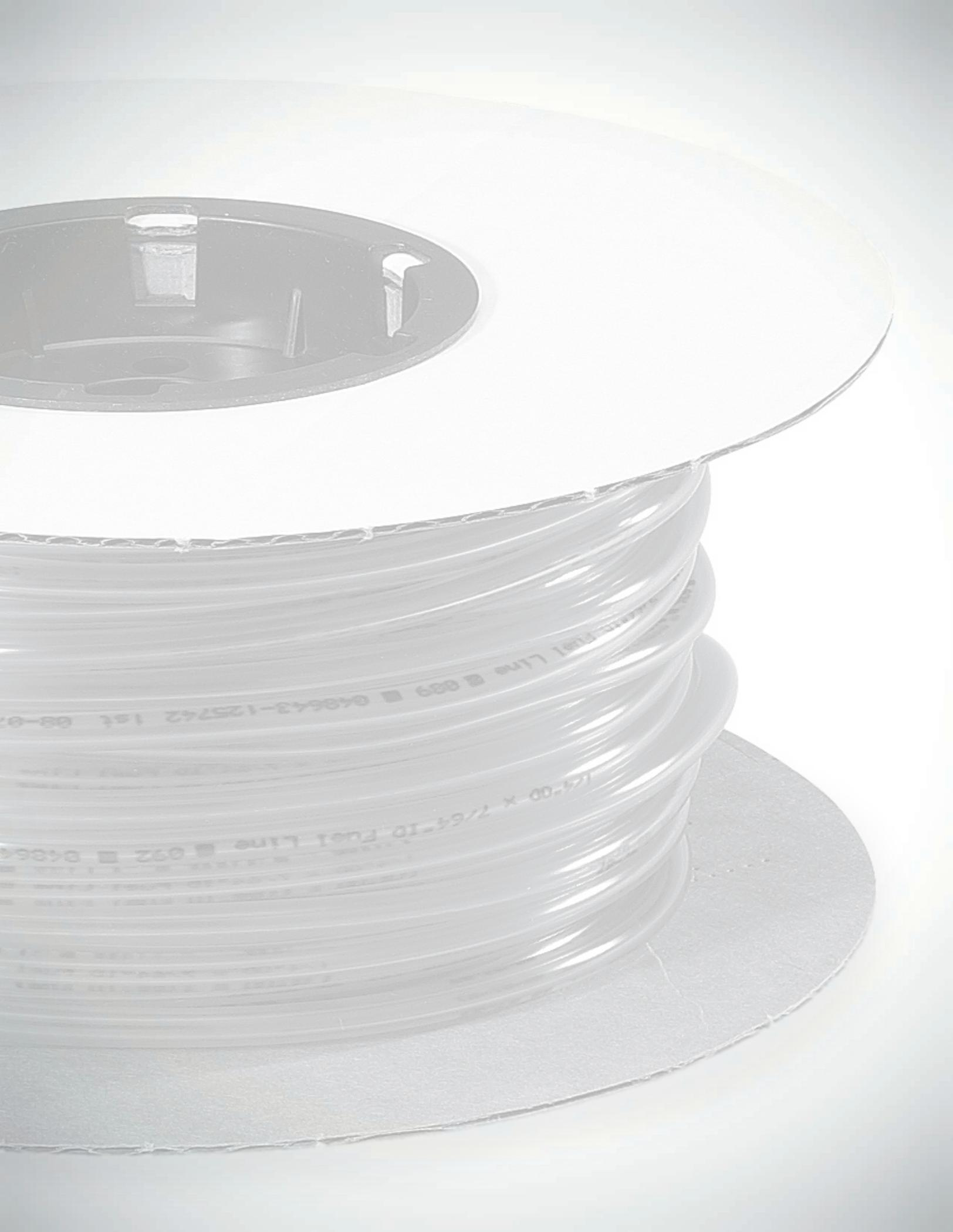

Fuel Line # 089 # 048643-125742 1st 08-02

1/4-00 x 2/64-10 Fuel Line # 092 # 048643

**Polyurethane Micro Fuel Line**

Item Number	Item Description	Pkg Type	Min Qty	Case Qty	Price
<b>1/4" OD</b>					
900-14010R00051	7/64" ID × 1/4" OD, Orange, 5' Coil	BI	10	10	\$5.74
900-14010R01005	7/64" ID × 1/4" OD, Orange, 100' Reel	BI	1	1	\$95.64
900-14023R00101	1/8" ID × 1/4 OD, Orange, 10' Coil	BI	5	5	\$9.54
<b>3/16" OD</b>					
900-14018R00051	3/32" ID × 3/16 OD, Orange, 5' Coil	BI	10	10	\$5.87
900-14018R01004	3/32" ID × 3/16 OD, Orange, 100' Reel	BI	1	1	\$97.80



900-14010R00051



900-14018R01004

**Polyester Reinforced Fuel Line**

· NOT FOR FUEL INJECTION APPLICATIONS

Item Number	Item Description	Pkg Type	Min Qty	Case Qty	Price
<b>1/2" OD</b>					
900-15106N00051	1/4" ID × 1/2", 5' Coil	CI	5	5	\$8.07
900-15106N01005	1/4" ID × 1/2", 100' Reel	BI	1	1	\$115.14
<b>5/8" OD</b>					
900-15157N00051	5/16" ID × 5/8", 5' Coil	CI	1	10	\$6.98
900-15166N00051	3/8" ID × 5/8", 5' Coil	CI	1	10	\$8.74



900-15106N00051



900-15166N00051

Supply

Drainage

Support

Specialties

Appendix



# **Gasket Material**

**Flat Gasket Material**







**Flat Gasket Material**

Item Number	Item Description	Pkg Type	Min Qty	Case Qty	Price
	<b>RED</b>				
899-306R0009	1/8" x 12" Rubber, 9' Reel	Bl	1	1	\$85.48

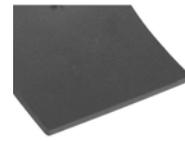

899-306R0018

Supply

Drainage

Support

Specialties

Appendix



# **Tubing/Hose Fittings**

**Compression, Flare**

**Brass Thread, Nylon Thread**

**Pipe Nipples, Poly Push Fittings**

**Hose Barb Fittings**

**Garden Hose Fittings**

**Hose Clamps, Valves & Cocks**

**Pool Hose Fittings**

# Tubing/Hose Fittings

## Compression Fittings

Compression fittings in brass and nylon material. Brass fittings for standard and Ander-Lign connections available.

## Flare Fittings

Brass flare fittings in standard and fine-thread styles. Flare fittings for LPG and gas range connection available.

## Threaded Fittings

Thread fittings in brass and nylon material. Brass fittings in bar-stock, forged, and cast options available.

## Pipe Nipples

Threaded pipe nipples in yellow brass, chrome-plated yellow brass, and red brass.

## Polypropylene Push Fittings

Easy-to-use polypropylene push fittings for use with LDPE tubing.

## Hose Barb Fittings

Fittings and adapters for hose barb connection in brass and nylon material.

## Garden Hose Fittings

Fittings and adapters for garden hose connection in brass and nylon material.

## Hose Clamps

Stainless steel worm-gear hose clamps and quick-connecting EasyClamps.

## Valves & Cocks

Self-piercing and drill-type saddle valves, drain cocks, and shutoff cocks.

## Pool Hose Fittings

Couplings and cuff fittings for pool hose.

# Brass Compression Fittings

**Couplings**

**Reducing Couplings**

**Tees**

**Elbows**

**Straight Adapters**

**Elbow Adapters**

**Ferrules**

**Caps**

**Nuts & Inserts**

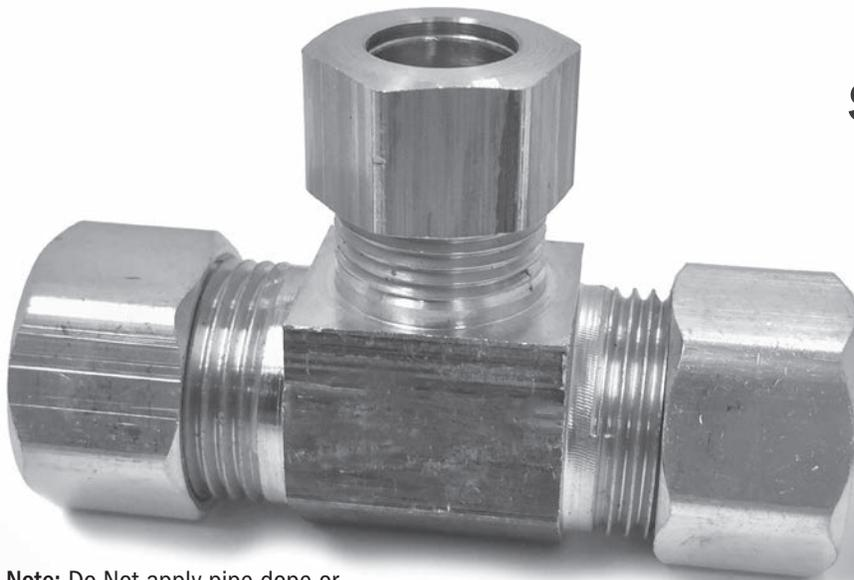

**Note:** Do Not apply pipe dope or other sealants to compression threads



**907-120201**  
Page 671



**907-13201001**  
Page



**907-1916161001**  
Page



**907-251601**  
Page 672



**907-40102005**  
Page 673



**907-44021001**  
Page 675



**907-43102001**  
Page 676



**907-27101601**  
Page 676



**909-32102001**  
Page 677



**907-010003**  
Page



**907-490201**  
Page 678



**907-080003**  
Page



**908-12020201**  
Page 683



**908-13100201**  
Page 683



**908-2002020201**  
Page 683



**908-25020201**  
Page 683



**908-40020201**  
Page 683



**908-27020201**  
Page 684

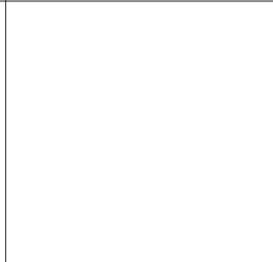
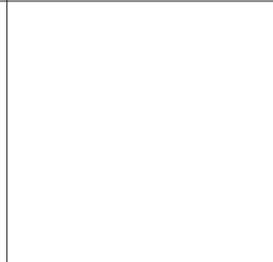

**Brass Compression Couplings**

Item Number	Item Description	Pkg Type	Min Qty	Case Qty	Price
<b>COMPRESSION</b>					
907-120201	1/4" OD Comp, 1/Bag	Bl	5	60	\$4.48
907-120205	1/4" OD Comp, 5/Bag	Bl	1	60	\$19.59
907-120210	1/4" OD Comp, 10/Bag	Bl	5	20	\$38.46
907-121001	3/8" OD Comp, 1/Bag	Bl	5	60	\$5.64
907-121005	3/8" OD Comp, 5/Bag	Bl	5	60	\$25.39
907-121601	1/2" OD Comp, 1/Bag	Bl	5	60	\$8.47
907-121605	1/2" OD Comp, 5/Bag	Bl	5	60	\$39.48
907-122001	5/8" OD Comp, 1/Bag	Bl	5	60	\$10.08
907-122005	5/8" OD Comp, 5/Bag	Bl	1	50	\$47.60
907-123001	7/8" OD Comp, 1/Bag	Bl	2	24	\$16.05
<b>ANDER-LIGN WITH BRASS INSERTS</b>					
909-120201	1/4" OD Ander-Lign, 1/Bag	Bl	10	120	\$4.02
909-120501	5/16" OD Ander-Lign, 1/Bag	Bl	5	60	\$4.35
909-121001	3/8" OD Ander-Lign, 1/Bag	Bl	10	60	\$4.73
909-121601	1/2" OD Ander-Lign, 1/Bag	Bl	5	60	\$8.17
909-122001	5/8" OD Ander-Lign, 1/Bag	Bl	5	60	\$10.32
909-123001	7/8" OD Ander-Lign, 1/Bag	Bl	2	24	\$15.82
<b>ANDER-LIGN LESS INSERTS</b>					
909-120001	1/8" OD Ander-Lign, 1/Bag	Bl	5	60	\$5.40
909-120101	3/16" OD Ander-Lign, 1/Bag	Bl	5	60	\$3.21



907-120201



909-120201



909-120001

**Brass Compression Reducing Couplings**

Item Number	Item Description	Pkg Type	Min Qty	Case Qty	Price
<b>COMPRESSION</b>					
907-13100201	3/8" x 1/4" OD Comp, 1/Bag	Bl	5	60	\$4.57
<b>ANDER-LIGN WITH BRASS INSERTS</b>					
909-13050201	5/16" x 1/4" OD Ander-Lign, 1/Bag	Bl	5	40	\$10.55
909-13100201	3/8" x 1/4" OD Ander-Lign, 1/Bag	Bl	5	60	\$7.29
909-13160201	1/2" x 1/4" OD Ander-Lign, 1/Bag	Bl	5	20	\$14.42
909-13161001	1/2" x 3/8" OD Ander-Lign, 1/Bag	Bl	5	60	\$7.38
909-13201001	5/8" x 3/8" OD Ander-Lign, 1/Bag	Bl	5	60	\$8.38
909-13201601	5/8" x 1/2" OD Ander-Lign, 1/Bag	Bl	5	60	\$14.42
909-13302001	7/8" x 5/8" OD Ander-Lign, 1/Bag	Bl	2	24	\$26.69
<b>ANDER-LIGN LESS INSERTS</b>					
909-13161060	1/2" x 3/8" OD Ander-Lign, 5/Bag	Bl	5	60	\$43.57



907-13201001



909-13100201

**Brass Compression Tees**

Item Number	Item Description	Pkg Type	Min Qty	Case Qty	Price
<b>STANDARD TEE</b>					
907-201001	3/8" OD Comp, 1/Bag	Bl	5	60	\$7.18



907-201001

Supply

Drainage

Support

Specialties

Appendix

Supply



907-1916161001

Drainage

Support



909-201001

Specialties

Appendix



907-251601



909-250201

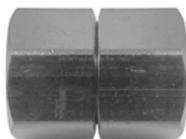

907-541001

### Brass Compression Tees (Cont)

Item Number	Item Description	Pkg Type	Min Qty	Case Qty	Price
<b>REDUCING TEE</b>					
907-1920201601	5/8" × 5/8" × 1/2" OD Comp, 1/Bag	BI	5	60	\$17.44
907-1930302001	7/8" × 7/8" × 5/8" OD Comp, 1/Bag	BI	2	24	\$59.21
907-24101001	3/8" × 3/8" OD Comp × 1/4" MIP, 1/Bag	BI	5	60	\$7.77
907-24202001	5/8" × 5/8" OD Comp × 1/2" MIP, 1/Bag	BI	5	60	\$16.44

### Brass Compression Tees

#### Ander-Lign With Brass Inserts

Item Number	Item Description	Pkg Type	Min Qty	Case Qty	Price
<b>STANDARD TEE</b>					
909-183001	7/8" OD Ander-Lign, 1/Bag	BI	2	24	\$46.73
909-200201	1/4" OD Ander-Lign, 1/Bag	BI	5	60	\$6.88
909-201001	3/8" OD Ander-Lign, 1/Bag	BI	5	120	\$7.49
909-201601	1/2" OD Ander-Lign, 1/Bag	BI	5	40	\$13.48
909-202001	5/8" OD Ander-Lign, 1/Bag	BI	5	60	\$15.05
<b>REDUCING TEE</b>					
909-21100201	3/8" × 3/8" × 1/4" OD Ander-Lign, 1/Bag	BI	5	60	\$8.98

### Brass Compression Elbows

Item Number	Item Description	Pkg Type	Min Qty	Case Qty	Price
<b>STANDARD</b>					
907-251601	1/2" OD Comp, 1/Bag	BI	5	60	\$9.03
<b>ANDER-LIGN WITH BRASS INSERTS</b>					
909-250201	1/4" OD Ander-Lign, 1/Bag	BI	5	40	\$6.19
909-251001	3/8" OD Ander-Lign, 1/Bag	BI	5	40	\$6.20
909-251601	1/2" OD Ander-Lign, 1/Bag	BI	5	20	\$11.05
909-252001	5/8" OD Ander-Lign, 1/Bag	BI	5	60	\$13.05
909-263001	7/8" OD Ander-Lign, 1/Bag	BI	2	24	\$39.02

### Brass Compression Straight Adapters

#### Female Compression

Item Number	Item Description	Pkg Type	Min Qty	Case Qty	Price
<b>FEMALE COMPRESSION × FEMALE COMPRESSION</b>					
907-541001	3/8" OD Female Comp, 1/Bag	BI	5	60	\$5.32



**Brass Compression Straight Adapters (Cont)**

**Female Compression**

Item Number	Item Description	Pkg Type	Min Qty	Case Qty	Price
<b>FEMALE COMPRESSION × COMPRESSION</b>					
907-47100200	3/8" OD Female Comp × 1/4" OD Comp, 100/Box	B	1	10	\$249.25
907-47100201	3/8" OD Female Comp × 1/4" OD Comp, 1/Bag	BI	5	60	\$2.71
907-47101601	3/8" OD Female Comp × 1/2" OD Comp, 1/Bag	BI	5	20	\$4.16
907-47151001	7/16" OD Female Comp × 3/8" OD Comp, 1/Bag	BI	5	60	\$4.03
907-47161001	1/2" OD Female Comp × 3/8" OD Comp, 1/Bag	BI	5	40	\$2.49
<b>ANDER-LIGN × FEMALE COMPRESSION LESS INSERTS</b>					
909-14100201	3/8" OD Ander-Lign × 1/4" OD Female Comp, 1/Bag	BI	5	60	\$5.63



907-47100200

**Brass Compression Straight Adapters**

**Compression × MIP**

Item Number	Item Description	Pkg Type	Min Qty	Case Qty	Price
<b>1/4" COMPRESSION</b>					
907-40021001	1/4" OD Comp × 1/4" MIP, 1/Bag	BI	5	60	\$3.35
<b>3/8" COMPRESSION</b>					
907-40101001	3/8" OD Comp × 1/4" MIP, 1/Bag	BI	5	60	\$3.74
907-40102005	3/8" OD Comp × 1/2" MIP, 5/Bag	BI	1	60	\$21.99
907-41102001	3/8" OD Comp × 1/2" MIP, 1/Bag	BI	5	60	\$5.77
907-41201005	3/8" OD Comp × 1/2" MIP, 5/Bag	BI	5	20	\$25.67
<b>5/8" COMPRESSION</b>					
907-4020200505	5/8" OD Comp × 1/2" MIP, 5/Bag	BI	5	60	\$31.10
907-41202001	5/8" OD Comp × 1/2" MIP, 1/Bag	BI	5	60	\$6.88
<b>7/8" COMPRESSION</b>					
907-40303001	7/8" OD Comp × 3/4" MIP, 1/Bag	BI	2	24	\$10.90



907-40102005

**Brass Compression Straight Adapters**

**Ander-Lign With Brass Insert × MIP**

Item Number	Item Description	Pkg Type	Min Qty	Case Qty	Price
<b>1/4" ANDER-LIGN COMPRESSION</b>					
909-40021001	1/4" OD Ander-Lign × 1/4" MIP, 1/Bag	BI	5	60	\$3.35
909-41020201	1/4" OD Ander-Lign × 1/8" MIP, 1/Bag	BI	5	60	\$3.01
909-41021601	1/4" OD Ander-Lign × 3/8" MIP, 1/Bag	BI	5	60	\$3.93
909-41022001	1/4" OD Ander-Lign × 1/2" MIP, 1/Bag	BI	5	60	\$5.40
<b>5/16" ANDER-LIGN COMPRESSION</b>					
909-41051001	5/16" OD Ander-Lign × 1/4" MIP, 1/Bag	BI	5	20	\$3.97
<b>3/8" ANDER-LIGN COMPRESSION</b>					
909-40101601	3/8" OD Ander-Lign × 3/8" MIP, 1/Bag	BI	5	60	\$4.68
909-41101001	3/8" OD Ander-Lign × 1/4" MIP, 1/Bag	BI	5	60	\$4.02
909-41102001	3/8" OD Ander-Lign × 1/2" MIP, 1/Bag	BI	10	120	\$5.78
909-41103001	3/8" OD Ander-Lign × 3/4" MIP, 1/Bag	BI	5	20	\$10.55



909-40021001

Supply

Drainage

Support

Specialties

Appendix

**Brass Compression Straight Adapters (Cont)**

**Ander-Lign With Brass Insert × MIP**



909-40303001

Item Number	Item Description	Pkg Type	Min Qty	Case Qty	Price
<b>1/2" ANDER-LIGN COMPRESSION</b>					
909-40162001	1/2" OD Ander-Lign × 1/2" MIP, 1/Bag	BI	5	60	\$7.27
909-41161601	1/2" OD Ander-Lign × 3/8" MIP, 1/Bag	BI	5	60	\$5.72
909-41163001	1/2" OD Ander-Lign × 3/4" MIP, 1/Bag	BI	5	60	\$7.51
<b>5/8" ANDER-LIGN COMPRESSION</b>					
909-40201601	5/8" OD Ander-Lign × 3/8" MIP, 1/Bag	BI	5	20	\$6.96
909-40203001	5/8" OD Ander-Lign × 3/4" MIP, 1/Bag	BI	5	60	\$14.06
909-41202001	5/8" OD Ander-Lign × 1/2" MIP, 1/Bag	BI	5	60	\$7.06
<b>3/4" ANDER-LIGN COMPRESSION</b>					
909-40253001	3/4" OD Ander-Lign × 3/4" MIP, 1/Bag	BI	5	60	\$16.15
<b>7/8" ANDER-LIGN COMPRESSION</b>					
909-40303001	7/8" OD Ander-Lign × 3/4" MIP, 1/Bag	BI	2	24	\$11.94

**Brass Compression Straight Adapters**

**Ander-Lign Less Insert × MIP**



909-4000201

Item Number	Item Description	Pkg Type	Min Qty	Case Qty	Price
<b>1/8" ANDER-LIGN COMPRESSION</b>					
909-4000201	1/8" OD Ander-Lign × 1/8" MIP, 1/Bag	BI	5	60	\$7.02
<b>3/16" ANDER-LIGN COMPRESSION</b>					
909-40010201	3/16" OD Ander-Lign × 1/8" MIP, 1/Bag	BI	5	60	\$3.47
<b>7/8" ANDER-LIGN COMPRESSION</b>					
909-41302001	7/8" OD Ander-Lign × 1/2" MIP, 1/Bag	BI	2	24	\$21.79
909-41303007	7/8" OD Ander-Lign × 3/4 MIP, 2/Clamshell	BI	5	30	\$15.25

**Brass Compression Straight Adapters**

**Female Compression × MIP**



907-58202001

Item Number	Item Description	Pkg Type	Min Qty	Case Qty	Price
<b>3/8" FEMALE COMPRESSION</b>					
907-58101001	3/8" Female Comp × 1/4" MIP, 1/Bag	BI	5	60	\$3.57
<b>1/2" FEMALE COMPRESSION</b>					
907-58161601	1/2" Female Comp × 3/8" MIP, 1/Bag	BI	5	60	\$4.14
<b>5/8" FEMALE COMPRESSION</b>					
907-58202001	5/8" Female Comp × 1/2" MIP, 1/Bag	BI	5	60	\$5.19

Supply

Drainage

Support

Specialties

Appendix

**Brass Compression Straight Adapters**

**Compression x FIP**

Item Number	Item Description	Pkg Type	Min Qty	Case Qty	Price
<b>1/4" COMPRESSION</b>					
907-44021001	1/4" OD Comp x 1/4" FIP, 1/Bag	Bl	5	60	\$4.52
<b>3/8" COMPRESSION</b>					
907-44101601	3/8" OD Comp x 3/8" FIP, 1/Bag	Bl	5	60	\$3.60
907-4410200505	3/8" OD Comp x 1/2" FIP, 5/Bag	Bl	5	60	\$21.44
907-45102001	3/8" OD Comp x 1/2" FIP, 1/Bag	Bl	5	60	\$4.53
<b>1/2" COMPRESSION</b>					
907-44162001	1/2" OD Comp x 1/2" FIP, 1/Bag	Bl	5	60	\$5.56
<b>5/8" COMPRESSION</b>					
907-45202001	5/8" OD Comp x 1/2" FIP, 1/Bag	Bl	5	60	\$6.38



907-44021001

**Brass Compression Straight Adapters**

**Ander-Lign With Brass Insert x FIP**

Item Number	Item Description	Pkg Type	Min Qty	Case Qty	Price
<b>1/4" ANDER-LIGN COMPRESSION</b>					
909-44021001	1/4" OD Ander-Lign x 1/4" FIP, 1/Bag	Bl	5	60	\$6.43
909-44021601	1/4" OD Ander-Lign x 3/8" FIP, 1/Bag	Bl	5	20	\$5.28
909-44022001	1/4" OD Ander-Lign x 1/2" FIP, 1/Bag	Bl	5	40	\$3.75
909-45020201	1/4" OD Ander-Lign x 1/8" FIP, 1/Bag	Bl	5	60	\$3.58
909-45022001	1/4" OD Ander-Lign x 1/2" FIP, 1/Bag	Bl	5	40	\$5.28
<b>5/16" ANDER-LIGN COMPRESSION</b>					
909-45051001	5/16" OD Ander-Lign x 1/4" FIP, 1/Bag	Bl	5	20	\$5.85
<b>3/8" ANDER-LIGN COMPRESSION</b>					
909-44101601	3/8" OD Ander-Lign x 3/8" FIP, 1/Bag	Bl	5	60	\$7.50
909-45101001	3/8" OD Ander-Lign x 1/4" FIP, 1/Bag	Bl	5	40	\$5.58
909-45102001	3/8" OD Ander-Lign x 1/2" FIP, 1/Bag	Bl	10	120	\$6.30
<b>1/2" ANDER-LIGN COMPRESSION</b>					
909-44161601	1/2" OD Ander-Lign x 3/8" FIP, 1/Bag	Bl	5	20	\$8.01
909-44162001	1/2" OD Ander-Lign x 1/2" FIP, 1/Bag	Bl	5	60	\$12.56
<b>5/8" ANDER-LIGN COMPRESSION</b>					
909-44203001	5/8" OD Ander-Lign x 3/4" FIP, 1/Bag	Bl	5	20	\$15.13
909-45202001	5/8" OD Ander-Lign x 1/2" FIP, 1/Bag	Bl	5	60	\$7.02
<b>7/8" ANDER-LIGN COMPRESSION</b>					
909-44303001	7/8" OD Ander-Lign x 3/4" FIP, 1/Bag	Bl	2	24	\$16.15



909-44021001



909-44303001

**Brass Compression Straight Adapters**

**Female Compression x FIP**

Item Number	Item Description	Pkg Type	Min Qty	Case Qty	Price
930-46101001	Gauge Adapter - 1/4" Swiv Comp. X 1/4" FIP, 1/Bag	Bl	5	60	\$4.42



930-46101001

Supply

Drainage

Support

Specialties

Appendix

Supply



907-43102001

Drainage



909-43102001

Support

Specialties



907-480201

Appendix



907-27101601



909-29021001

## Brass Compression Straight Adapters

### FSWT Adapters

Item Number	Item Description	Pkg Type	Min Qty	Case Qty	Price
<b>COMPRESSION × FSWT</b>					
907-43102001	3/8" OD Comp × 1/2" FSWT, 1/Bag	BI	5	60	\$4.83
<b>ANDER-LIGN WITH BRASS INSERT × FSWT</b>					
909-43102001	3/8" OD Ander-Lign × 1/2" FSWT, 1/Bag	BI	5	40	\$4.92

## Brass Compression to Flare Adapters

Item Number	Item Description	Pkg Type	Min Qty	Case Qty	Price
907-480201	1/4" OD Comp × 1/4" Female Flare w/Gasket, 1/Bag	BI	5	60	\$4.44
907-481001	3/8" OD Comp × 3/8" Female Flare w/Gasket, 1/Bag	BI	5	40	\$3.24

## Brass Compression Elbow Adapters

### Compression × MIP

Item Number	Item Description	Pkg Type	Min Qty	Case Qty	Price
<b>3/8" COMPRESSION</b>					
907-27101601	3/8" OD Comp × 3/8" MIP, 1/Bag	BI	5	60	\$5.34
907-27101605	3/8" OD Comp × 3/8" MIP, 5/Bag	BI	5	20	\$23.35

## Brass Compression Elbow Adapters

### Ander-Lign With Brass Insert × MIP

Item Number	Item Description	Pkg Type	Min Qty	Case Qty	Price
<b>1/4" ANDER-LIGN COMPRESSION</b>					
909-29021001	1/4" OD Ander-Lign × 1/4" MIP, 1/Bag	BI	5	40	\$4.48
909-30020201	1/4" OD Ander-Lign × 1/8" MIP, 1/Bag	BI	5	40	\$4.39
<b>3/8" ANDER-LIGN COMPRESSION</b>					
909-29101601	3/8" OD Ander-Lign × 3/8" MIP, 1/Bag	BI	5	60	\$5.81
909-30101001	3/8" OD Ander-Lign × 1/4" MIP, 1/Bag	BI	5	40	\$5.26
909-30102001	3/8" OD Ander-Lign × 1/2" MIP, 1/Bag	BI	5	40	\$10.30
<b>1/2" ANDER-LIGN COMPRESSION</b>					
909-29162001	1/2" OD Ander-Lign × 1/2" MIP, 1/Bag	BI	5	20	\$7.27
909-30161601	1/2" OD Ander-Lign × 3/8" MIP, 1/Bag	BI	5	40	\$8.03

**Brass Compression Elbow Adapters (Cont)**

**Ander-Lign With Brass Insert × MIP**

Item Number	Item Description	Pkg Type	Min Qty	Case Qty	Price
<b>5/8" ANDER-LIGN COMPRESSION</b>					
909-30201601	5/8" OD Ander-Lign × 3/8" MIP, 1/Bag	BI	5	20	\$10.40
909-30202001	5/8" OD Ander-Lign × 1/2" MIP, 1/Bag	BI	5	40	\$10.48

**Brass Compression Elbow Adapters**

**Compression × FIP**

Item Number	Item Description	Pkg Type	Min Qty	Case Qty	Price
<b>3/8" COMPRESSION</b>					
907-32102010	3/8" OD Comp × 1/2" FIP, 10/Bag	B	1	10	\$57.78

**Brass Compression Elbow Adapters**

**Ander-Lign Less Insert × FIP**

Item Number	Item Description	Pkg Type	Min Qty	Case Qty	Price
909-32102001	3/8" OD Ander-Lign × 1/2" FIP, 1/Bag	BI	5	60	\$8.44
909-32202001	5/8" OD Ander-Lign × 1/2" FIP, 1/Bag	BI	5	60	\$15.13



909-32102001

**Ferrules**

Item Number	Item Description	Pkg Type	Min Qty	Case Qty	Price
<b>BRASS COMPRESSION</b>					
907-010103	3/16" OD Comp, 3/Bag	BI	5	60	\$1.46
907-010203	1/4" OD Comp, 3/Bag	BI	10	120	\$1.30
907-010503	5/16" OD Comp, 3/Bag	BI	5	20	\$1.46
907-011003	3/8" OD Comp, 3/Bag	BI	10	120	\$1.35
907-011603	1/2" OD Comp, 3/Bag	BI	5	60	\$1.49
907-011625	1/2" OD Comp, 25/Bag	BI	5	60	\$12.35
907-012003	5/8" OD Comp, 3/Bag	BI	5	60	\$1.96
907-012503	3/4" OD Comp, 3/Bag	BI	5	60	\$4.52
907-013003	7/8" OD Comp, 3/Bag	BI	5	60	\$3.63
<b>POLY COMPRESSION WITH BRASS INSERT</b>					
907-050202	1/4" OD Comp, 2/Bag	BI	10	120	\$2.71
907-050502	5/16" OD Comp, 2/Bag	BI	5	60	\$3.64
907-051002	3/8" OD Comp, 2/Bag	BI	5	60	\$2.12
907-051602	1/2" OD Comp, 2/Bag	BI	5	60	\$2.30



907-010003



907-050202

Supply

Drainage

Support

Specialties

Appendix

Supply

Drainage

Support

Specialties

Appendix



907-020203

### Ferrules (Cont)

Item Number	Item Description	Pkg Type	Min Qty	Case Qty	Price
<b>POLY COMPRESSION LESS INSERT</b>					
907-020203	1/4" OD Comp, 3/Bag	BI	10	120	\$0.89
907-020210	1/4" OD Comp, 10/Bg	BI	1	480	\$2.98
907-020225	1/4" OD Comp, 25/Bag	BI	1	60	\$3.62
907-021000	3/8" OD Comp, 100/Bx	BI	1	50	\$11.94
907-021003	3/8" OD Comp, 3/Bag	BI	10	120	\$1.28
907-021025	3/8" OD Comp, 25/Bag	BI	5	60	\$6.13
907-022003	5/8" OD Comp, 3/Bag	BI	5	20	\$1.32
907-022010	5/8" OD Comp, 10/Bg	BI	1	150	\$3.71



907-490201

### Caps

· Brass compression caps require a brass compression ferrule to create a seal

Item Number	Item Description	Pkg Type	Min Qty	Case Qty	Price
<b>BRASS CAPS</b>					
907-490201	1/4" OD Comp, 1/Bag	BI	5	60	\$1.29
907-490501	5/16" OD Comp, 1/Bag	BI	5	60	\$1.51
907-491001	3/8" OD Comp, 1/Bag	BI	5	60	\$0.89
907-491010	3/8" OD Comp, 10/Bag	BI	5	60	\$9.03
907-491601	1/2" OD Comp, 1/Bag	BI	5	40	\$1.08
907-492001	5/8" OD Comp, 1/Bag	BI	5	40	\$1.18
<b>NYLON CAPS</b>					
688-C0B	1/4" Nylon Comp. Thread Cap, 10/Bag	BI	1	10	\$5.56
688-C1B	3/8" Nylon Comp. Thread Cap, 25/Bag	BI	1	4	\$6.67



688-C0B

### Nuts & Inserts

Item Number	Item Description	Pkg Type	Min Qty	Case Qty	Price
<b>BRASS COMPRESSION NUTS</b>					
907-080103	3/16" OD Comp, 3/Bag	BI	5	60	\$2.04
907-080203	1/4" OD Comp, 3/Bag	BI	10	120	\$2.30
907-080503	5/16" OD Comp, 3/Bag	BI	5	60	\$3.02
907-081000	3/8" OD Comp, 100/Bag	BI	1	5	\$63.63
907-081003	3/8" OD Comp, 3/Bag	BI	10	120	\$2.86
907-081025	3/8" OD Comp, 25/Bag	BI	5	20	\$18.84
907-081603	1/2" OD Comp, 3/Bag	BI	5	40	\$4.91
907-081625	1/2" OD Comp, 25/Bag	BI	5	60	\$35.73
907-082003	5/8" OD Comp, 3/Bag	BI	5	40	\$5.33
907-082025	5/8" OD Comp, 25/Bag	BI	5	30	\$39.18
<b>CHROME-PLATED BRASS COMPRESSION NUTS/FERRULES</b>					
908-061002	3/8" OD Comp, 2/Bag	BI	5	60	\$2.81
908-061602	1/2" OD Comp, 2/Bag	BI	5	20	\$5.98
908-070202	1/4" OD Comp, 2/Bag	BI	5	60	\$2.12



907-080003



908-061002

**Nuts & Inserts (Cont)**

Item Number	Item Description	Pkg Type	Min Qty	Case Qty	Price
<b>ANDER-LIGN BRASS INSERTS</b>					
909-030200	1/4" OD Ander-Lign, 100/Box	Bl	1	50	\$14.74
909-030203	1/4" OD Ander-Lign, 3/Bag	Bl	5	60	\$1.86
909-031000	3/8" OD Ander-Lign, 100/Bag	Bl	1	10	\$21.74
909-031003	3/8" OD Ander-Lign, 3/Bag	Bl	5	60	\$2.31
909-031603	1/2" OD Ander-Lign, 3/Bag	Bl	5	60	\$1.76
909-032003	5/8" OD Ander-Lign, 3/Bag	Bl	5	60	\$2.09
909-032010	5/8" OD Ander-Lign, 10/Bag	Bl	1	10	\$5.33
<b>ANDER-LIGN BRASS NUTS/INSERTS</b>					
909-070201	1/4" OD Comp, 1/Bag	Bl	10	120	\$1.79
909-070501	5/16" OD Comp, 1/Bag	Bl	5	60	\$2.54
909-071001	3/8" OD Comp, 1/Bag	Bl	10	120	\$2.10
909-071601	1/2" OD Comp, 1/Bag	Bl	5	20	\$3.52
909-072001	5/8" OD Comp, 1/Bag	Bl	5	40	\$5.73
909-073001	7/8" OD Comp, 1/Bag	Bl	5	60	\$7.55

**Pilot Line Breakaway Compression Nut**

Item Number	Item Description	Pkg Type	Min Qty	Case Qty	Price
907-L990201	1/4" OD Comp Breakaway Nut, 1/Bag	Bl	10	120	\$2.46



909-030200



909-070201



907-L990201

Supply

Drainage

Support

Specialties

Appendix





# **Nylon Compression Fittings**

**Couplings**

**Reducing Couplings**

**Tees**

**Elbows**

**Straight Adapters**

**Elbow Adapters**





**Nylon Couplings**

Item Number	Item Description	Pkg Type	Min Qty	Case Qty	Price
908-12020201	1/4" OD Comp	BI	5	60	\$4.99
908-12101001	3/8" OD Comp	BI	5	60	\$7.40
908-12161601	1/2" OD Comp	BI	5	60	\$18.88



908-12020201

**Nylon Reducing Couplings**

Item Number	Item Description	Pkg Type	Min Qty	Case Qty	Price
908-13100201	3/8" x 1/4" OD Comp	BI	5	60	\$5.63
908-13161001	1/2" x 3/8" OD Comp	BI	5	60	\$7.02



908-13100201

**Nylon Tees**

Item Number	Item Description	Pkg Type	Min Qty	Case Qty	Price
908-2002020201	1/4" x 1/4" x 1/4" OD Comp	BI	5	60	\$7.38
908-2010101001	3/8" x 3/8" x 3/8" OD Comp	BI	5	60	\$11.54
908-2210101001	1/4" x 1/4" OD Comp x 1/4" MIP	BI	5	60	\$7.75



908-2002020201

**Nylon Elbows**

Item Number	Item Description	Pkg Type	Min Qty	Case Qty	Price
908-25020201	1/4" OD Comp	BI	5	60	\$5.98
908-25101001	3/8" OD Comp	BI	5	60	\$7.38



908-25020201

**Nylon Straight Adapters**

**MIP**

Item Number	Item Description	Pkg Type	Min Qty	Case Qty	Price
908-40020201	1/4" OD Comp x 1/8" MIP	BI	5	60	\$3.86
908-40021001	1/4" OD Comp x 1/4" MIP	BI	5	60	\$3.50
908-40021601	1/4" OD Comp x 3/8" MIP	BI	5	60	\$4.22
908-40100201	3/8" OD Comp x 1/8" MIP	BI	5	60	\$4.25
908-40101001	3/8" OD Comp x 1/4" MIP	BI	5	60	\$4.27
908-40101601	3/8" OD Comp x 3/8" MIP	BI	5	60	\$4.54
908-40161601	1/2" OD Comp x 3/8" MIP	BI	5	60	\$5.28



908-40020201

Supply

Drainage

Support

Specialties

Appendix

**Nylon Elbow Adapters**

**MIP**



908-27020201

Item Number	Item Description	Pkg Type	Min Qty	Case Qty	Price
908-27020201	1/4" OD Comp × 1/8" MIP	BI	5	60	\$6.68
908-27021001	1/4" OD Comp × 1/4" MIP	BI	5	60	\$6.61
908-27021601	1/4" OD Comp × 3/8" MIP	BI	5	60	\$4.95
908-27101001	3/8" OD Comp × 1/4" MIP	BI	5	60	\$6.39

Supply

Drainage

Support

Specialties

Appendix

# Brass Flare Fittings

## Flare

Couplings

Reducing  
Couplings

Swivel Unions

Tees, Elbows

Straight  
Adapters

Elbow Adapters

Caps, Nuts

Plugs

## Fine-Thread Flare

Couplings

Tees

Straight Adapters

Elbow Adapters

Compression  
Adapters

Caps, Nuts





**975-103001**  
Page 687



**975-13161010**  
Page



**975-46202001**  
Page 687



**975-2020202001**  
Page 687



**975-251001**  
Page 688



**975-40021601**  
Page



**975-442016**  
Page 689



**975-31101601**  
Page 689



**975-490201**  
Page 690



**975-510205**  
Page 690



**978-12101001**  
Page



**978-201001**  
Page



**978-40102001**  
Page 691



**978-44101001**  
Page 691



**978-27101605**  
Page



**978-47021001**  
Page 691



**979-400201**  
Page



**958-48322001**  
Page

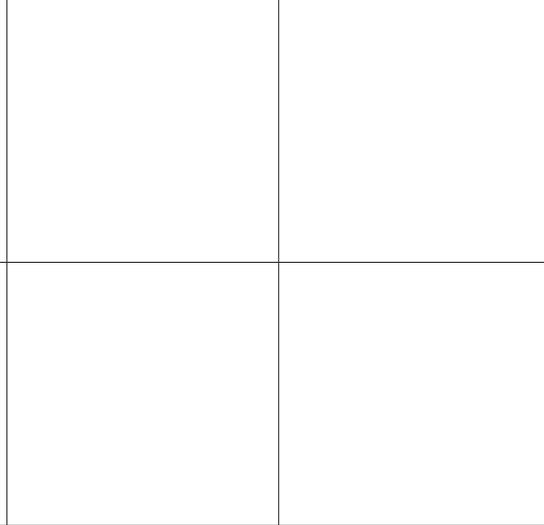

**Brass Flare Couplings**

Item Number	Item Description	Pkg Type	Min Qty	Case Qty	Price
975-103001	7/8" OD Flare, 1/Bag	BI	2	24	\$33.98
975-120201	1/4" OD Flare, 1/Bag	BI	5	20	\$2.23
975-121001	3/8" OD Flare, 1/Bag	BI	5	60	\$2.88
975-121601	1/2" OD Flare, 1/Bag	BI	5	60	\$5.39
975-122001	5/8" OD Flare, 1/Bag	BI	5	20	\$7.28



975-103001

**Brass Flare Reducing Couplings**

Item Number	Item Description	Pkg Type	Min Qty	Case Qty	Price
975-13100201	3/8" x 1/4" OD Flare, 1/Bag	BI	5	20	\$3.11
975-13161001	1/2" x 3/8" OD Flare, 1/Bag	BI	5	60	\$3.98
975-13201001	5/8" x 3/8" OD Flare, 1/Bag	BI	5	60	\$8.54
975-13201601	5/8" x 1/2" OD Flare, 1/Bag	BI	5	60	\$5.90



975-13161001

**Brass Flare Swivel Unions**

Item Number	Item Description	Pkg Type	Min Qty	Case Qty	Price
975-46161601	1/2" OD Female Flare, 1/Bag	BI	5	40	\$7.83
975-46202001	5/8" OD Female Flare, 1/Bag	BI	5	60	\$10.93
975-L541001	3/8" OD Female Flare, 1/Bag	BI	5	60	\$5.91



975-46202001

**Brass Flare Tees**

Item Number	Item Description	Pkg Type	Min Qty	Case Qty	Price
<b>STANDARD TEE</b>					
975-200201	1/4" OD Flare, 1/Bag	BI	5	20	\$4.56
975-201001	3/8" OD Flare, 1/Bag	BI	5	60	\$5.97
975-201601	1/2" OD Flare, 1/Bag	BI	5	60	\$6.45
975-2020202001	5/8" OD Flare, 1/Bag	BI	5	20	\$11.07
<b>REDUCING TEE</b>					
975-2110100201	3/8" x 3/8" x 1/4" OD Flare, 1/Bag	BI	5	60	\$7.07
975-2116161001	1/2" x 1/2" x 3/8" OD Flare, 1/Bag	BI	5	60	\$7.92
975-2120201601	5/8" x 5/8" x 1/2" OD Flare, 1/Bag	BI	5	60	\$12.63



975-2020202001



975-2110100201

Supply

Drainage

Support

Specialties

Appendix

Supply

Drainage

Support

Specialties

Appendix



975-251001

### Brass Flare Elbows

Item Number	Item Description	Pkg Type	Min Qty	Case Qty	Price
975-251001	3/8" OD Flare, 1/Bag	BI	5	40	\$4.65
975-251601	1/2" OD Flare, 1/Bag	BI	5	40	\$6.71



975-40021601

### Brass Flare Straight Adapters

#### MIP

Item Number	Item Description	Pkg Type	Min Qty	Case Qty	Price
<b>1/4" FLARE</b>					
975-40021001	1/4" OD Flare × 1/4" MIP, 1/Bag	BI	5	40	\$2.11
975-41021601	1/4" OD Flare × 3/8" MIP, 1/Bag	BI	5	60	\$3.50
<b>5/16" FLARE</b>					
975-40050001	5/16" OD Flare × 1/8" MIP, 1/Bag	BI	5	60	\$2.73
975-40050201	5/16" OD Flare × 1/4" MIP, 1/Bag	BI	5	60	\$2.45
<b>3/8" FLARE</b>					
975-40100001	3/8" OD Flare × 1/8" MIP, 1/Bag	BI	5	60	\$5.93
975-40101601	3/8" OD Flare × 3/8" MIP, 1/Bag	BI	5	60	\$2.90
975-40101605	3/8" OD Flare × 1/2" MIP, 5/Bag	BI	5	60	\$25.63
975-41101001	3/8" OD Flare × 1/4" MIP, 1/Bag	BI	5	40	\$2.45
975-41102001	3/8" OD Flare × 1/2" MIP, 1/Bag	BI	10	120	\$3.72
<b>1/2" FLARE</b>					
975-40162001	1/2" OD Flare × 1/2" MIP, 1/Bag	BI	5	60	\$3.98
975-40162501	1/2" OD Flare × 3/4" MIP, 1/Bag	BI	5	60	\$6.39
975-41161601	1/2" OD Flare × 3/8" MIP, 1/Bag	BI	5	60	\$3.52
<b>5/8" FLARE</b>					
975-41202001	5/8" OD Flare × 1/2" MIP, 1/Bag	BI	5	60	\$5.31
975-41203001	5/8" OD Flare × 3/4" MIP, 1/Bag	BI	5	20	\$5.93
<b>3/4" FLARE</b>					
975-40252501	3/4" OD Flare × 3/4" MIP, 1/Bag	BI	5	60	\$9.62



975-442016

### Brass Flare Straight Adapters

#### FIP

Item Number	Item Description	Pkg Type	Min Qty	Case Qty	Price
<b>3/8" FLARE</b>					
975-44101601	3/8" OD Flare × 3/8" FIP, 1/Bag	BI	5	60	\$3.50
975-44102501	3/8" OD Flare × 3/4" FIP, 1/Bag	BI	5	60	\$6.55
975-45101001	3/8" OD Flare × 1/4" FIP, 1/Bag	BI	5	20	\$2.84
975-45102001	3/8" OD Flare × 1/2" FIP, 1/Bag	BI	10	120	\$4.42
<b>1/2" FLARE</b>					
975-44161001	1/2" OD Flare × 3/8" FIP, 1/Bag	BI	5	40	\$3.57
975-44162001	1/2" OD Flare × 1/2" FIP, 1/Bag	BI	5	60	\$4.51
975-44162501	1/2" OD Flare × 3/4" FIP, 1/Bag	BI	5	60	\$6.65



**Brass Flare Straight Adapters (Cont)**

**FIP**

Item Number	Item Description	Pkg Type	Min Qty	Case Qty	Price
<b>5/8" FLARE</b>					
975-442016	5/8" OD Flare × 1/2" FIP, 5/Bag	Bl	5	15	\$68.02
975-44202501	5/8" OD Flare × 3/4" FIP, 1/Bag	Bl	5	20	\$6.34
975-45202001	5/8" OD Flare × 1/2" FIP, 1/Bag	Bl	5	40	\$5.04
<b>3/4" FLARE</b>					
975-44252501	3/4" OD Flare × 3/4" FIP, 1/Bag	Bl	5	60	\$16.98

**Brass Flare Elbow Adapters**

**MIP**

Item Number	Item Description	Pkg Type	Min Qty	Case Qty	Price
<b>1/4" FLARE</b>					
975-27020001	1/4" OD Flare × 1/8" MIP, 1/Bag	Bl	10	40	\$5.93
975-27020201	1/4" OD Flare × 1/4" MIP, 1/Bag	Bl	5	60	\$3.73
<b>3/8" FLARE</b>					
975-27100201	3/8" OD Flare × 1/4" MIP, 1/Bag	Bl	5	20	\$4.48
975-27101601	3/8" OD Flare × 3/8" MIP, 1/Bag	Bl	5	60	\$4.00
975-28102001	3/8" OD Flare × 1/2" MIP, 1/Bag	Bl	5	60	\$5.06
<b>1/2" FLARE</b>					
975-27161001	1/2" OD Flare × 3/8" MIP, 1/Bag	Bl	5	40	\$7.28
975-27162001	1/2" OD Flare × 1/2" MIP, 1/Bag	Bl	5	40	\$7.67
<b>5/8" FLARE</b>					
975-27201601	5/8" OD Flare × 1/2" MIP, 1/Bag	Bl	5	20	\$14.80



975-27101010

**Brass Flare Elbow Adapters**

**FIP**

Item Number	Item Description	Pkg Type	Min Qty	Case Qty	Price
<b>3/8" FLARE</b>					
975-31101001	3/8" OD Flare × 3/8" FIP, 1/Bag	Bl	5	20	\$4.91
975-31101601	3/8" OD Flare × 1/2" FIP, 1/Bag	Bl	5	60	\$4.91
<b>1/2" FLARE</b>					
975-31161001	1/2" OD Flare × 3/8" FIP, 1/Bag	Bl	5	60	\$6.65
<b>5/8" FLARE</b>					
975-31201601	5/8" OD Flare × 1/2" FIP, 1/Bag	Bl	5	60	\$13.09



975-31101601

Supply

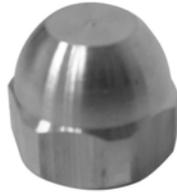

975-490201

### Brass Flare Caps

Item Number	Item Description	Pkg Type	Min Qty	Case Qty	Price
975-490201	1/4" OD Flare, 1/Bag	BI	5	60	\$1.34
975-490501	5/16" OD Flare, 1/Bag	BI	5	60	\$3.64
975-491001	3/8" OD Flare, 1/Bag	BI	5	60	\$1.97
975-491601	1/2" OD Flare, 1/Bag	BI	5	60	\$2.73
975-492001	5/8" OD Flare, 1/Bag	BI	5	40	\$4.77

Drainage

Support



975-080501

### Brass Flare Nuts

Item Number	Item Description	Pkg Type	Min Qty	Case Qty	Price
<b>SHORT ROD NUTS</b>					
975-080201	1/4" OD Flare, 1/Bag	BI	5	60	\$1.42
975-080501	5/16" OD Flare, 1/Bag	BI	5	60	\$2.16
975-081001	3/8" OD Flare, 1/Bag	BI	10	120	\$1.60
975-081010	3/8" OD Flare, 10/Bag	BI	5	60	\$15.65
975-081601	1/2" OD Flare, 1/Bag	BI	5	60	\$2.13
975-082001	5/8" OD Flare, 1/Bag	BI	5	60	\$3.23
<b>LONG ROD NUTS</b>					
975-101001	3/8" OD Flare, 1/Bag	BI	10	120	\$3.52
975-101601	1/2" OD Flare, 1/Bag	BI	10	120	\$5.61
975-102001	5/8" OD Flare, 1/Bag	BI	10	120	\$9.22
<b>SHORT FORGED NUTS</b>					
975-091001	3/8" OD Flare, 1/Bag	BI	5	60	\$2.46
975-091601	1/2" OD Flare, 1/Bag	BI	5	60	\$3.23
975-092001	5/8" OD Flare, 1/Bag	BI	5	60	\$4.78

Specialties



975-101001

Appendix



975-091601

### Brass Flare Plugs

Item Number	Item Description	Pkg Type	Min Qty	Case Qty	Price
975-510205	1/4" OD Flare, 1/Bag	BI	5	20	\$7.89
975-511005	3/8" OD Flare, 1/Bag	BI	5	60	\$3.61
975-511605	1/2" OD Flare, 1/Bag	BI	5	40	\$4.73
975-512005	5/8" OD Flare, 1/Bag	BI	5	20	\$9.21



975-510205

**Brass Fine Thread Flare Straight Adapters**

**MIP**

Item Number	Item Description	Pkg Type	Min Qty	Case Qty	Price
978-40102001	3/8" OD Fine Thread Flare × 1/2" MIP	BI	5	40	\$5.77



978-40101601

**Brass Fine Thread Flare Straight Adapters**

**FIP**

Item Number	Item Description	Pkg Type	Min Qty	Case Qty	Price
978-44101001	3/8" OD Fine Thread Flare × 3/8" FIP	BI	5	60	\$3.72
978-44101601	3/8" OD Fine Thread Flare × 1/2" FIP	BI	5	60	\$4.12



978-44101001

**Brass Fine Thread Flare Compression Adapters**

Item Number	Item Description	Pkg Type	Min Qty	Case Qty	Price
978-47021001	3/8" Female Fine Thread Flare × 1/4" OD Comp, 1/Bag	BI	5	40	\$4.28
978-47101001	3/8" Female Fine Thread Flare × 3/8" OD Comp, 1/Bag	BI	5	60	\$5.93



978-47021001

**Brass Fine Thread Flare Caps**

Item Number	Item Description	Pkg Type	Min Qty	Case Qty	Price
978-491001	3/8" OD Fine Thread Flare	BI	5	60	\$2.78



978-491001

**Brass Fine Thread Flare Nut**

Item Number	Item Description	Pkg Type	Min Qty	Case Qty	Price
978-081001	3/8" OD Fine Thread Flare, 1/Bag	BI	5	60	\$2.53

Supply

Drainage

Support

Specialties

Appendix

### Gas Range Fittings



958-48322001

Item Number	Item Description	Pkg Type	Min Qty	Case Qty	Price
<b>FLARE X FLARE ADAPTER</b>					
958-44322001	5/8" OD Female Flare × 15/16" OD Male Flare, 100/Box	B	1	1	\$698.19

Supply

Drainage

Support

Specialties

Appendix

# **Bar Stock & Forged Fittings**

**Couplings, Reducing Couplings**

**Unions, Tees, Elbows**

**Straight Adapters**

**Caps, Hex Bushings**

**Face Bushings, Hex Nipples**

**Reducing Hex Nipples**

**Ball Valves, Locknuts**

**Plugs**



Supply



930-120201

### Bar-Stock Couplings

Item Number	Item Description	Pkg Type	Min Qty	Case Qty	Price
930-120201	1/8" FIP, 1/Bag	BI	5	60	\$1.52
930-121001	1/4" FIP, 1/Bag	BI	5	60	\$1.79
930-121601	3/8" FIP, 1/Bag	BI	5	60	\$2.72
930-122001	1/2" FIP, 1/Bag	BI	5	60	\$4.19
930-122010	1/2" FIP, 10/Bag	BI	1	30	\$31.50
930-123001	3/4" FIP, 1/Bag	BI	5	60	\$4.70

Drainage

Support

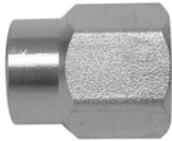

930-13100201

### Bar-Stock Reduced Couplings

Item Number	Item Description	Pkg Type	Min Qty	Case Qty	Price
930-13100201	1/4" FIP × 1/8" FIP, 1/Bag	BI	5	60	\$2.30
930-13160201	3/8" FIP × 1/8" FIP, 1/Bag	BI	5	20	\$4.26
930-13161001	3/8" FIP × 1/4" FIP, 1/Bag	BI	5	60	\$3.01
930-13200201	1/2" FIP × 1/8" FIP, 1/Bag	BI	5	20	\$10.93
930-13201001	1/2" FIP × 1/4" FIP, 1/Bag	BI	5	60	\$4.42
930-13201601	1/2" FIP × 3/8" FIP, 1/Bag	BI	5	60	\$3.96
930-13302001	3/4" FIP × 1/2" FIP, 1/Bag	BI	5	60	\$7.56

Specialties

Appendix



930-540201

### Bar-Stock Union Adapters

Item Number	Item Description	Pkg Type	Min Qty	Case Qty	Price
930-541001	1/4" FIP × 1/4" FIP, 1/Bag	BI	5	60	\$16.72
930-543001	3/4" FIP × 3/4" FIP, 1/Bag	BI	5	60	\$33.73

### Bar-Stock Tees



930-200201

Item Number	Item Description	Pkg Type	Min Qty	Case Qty	Price
<b>STANDARD TEE</b>					
930-200201	1/8" FIP, 1/Bag	BI	5	20	\$3.75
930-201001	1/4" FIP, 1/Bag	BI	5	60	\$3.74
930-201601	3/8" FIP, 1/Bag	BI	5	60	\$6.32
930-202001	1/2" FIP, 1/Bag	BI	5	60	\$9.53
930-203001	3/4" FIP, 1/Bag	BI	5	60	\$17.90
<b>REDUCING TEE</b>					
930-21161001	3/8" FIP × 3/8" FIP × 1/4" FIP, 1/Bag	BI	5	60	\$15.42

Bar-Stock Elbows

Item Number	Item Description	Pkg Type	Min Qty	Case Qty	Price
<b>90°</b>					
930-250201	1/8" FIP, 1/Bag	Bl	5	20	\$2.62
930-251001	1/4" FIP, 1/Bag	Bl	5	60	\$3.99
930-251601	3/8" FIP, 1/Bag	Bl	5	40	\$5.22
930-252001	1/2" FIP, 1/Bag	Bl	5	60	\$7.49
930-253001	3/4" FIP, 1/Bag	Bl	5	40	\$15.50
930-257001	2" FIP, 1/Bag	Bl	2	24	\$76.88



930-250201

Bar-Stock Street Elbows

Item Number	Item Description	Pkg Type	Min Qty	Case Qty	Price
<b>90° STREET</b>					
930-270201	1/8" MIP x 1/8" FIP, 1/Bag	Bl	5	60	\$1.91
930-270210	1/8" MIP x 1/8" FIP, 10/Bag	Bl	1	80	\$19.80
930-271001	1/4" MIP x 1/4" FIP, 1/Bag	Bl	5	60	\$3.11
930-271010	1/4" MIP x 1/4" FIP, 10/Bag	Bl	1	50	\$25.67
930-271601	3/8" MIP x 3/8" FIP, 1/Bag	Bl	5	60	\$4.64
930-271610	3/8" MIP x 3/8" FIP, 10/Bag	Bl	1	12	\$42.55
930-272001	1/2" MIP x 1/2" FIP, 1/Bag (Forged Fitting)	Bl	5	60	\$9.73
930-273001	3/4" MIP x 3/4" FIP, 1/Bag (Forged Fitting)	Bl	5	60	\$13.22
<b>45° STREET</b>					
930-380201	1/8" MIP x 1/8" FIP, 1/Bag	Bl	5	60	\$9.42
930-381005	1/4" MIP x 1/4" FIP, 1/Bag	Bl	5	60	\$18.54



930-270201

Bar-Stock Straight Adapters

MIP x FIP

Item Number	Item Description	Pkg Type	Min Qty	Case Qty	Price
930-56100201	1/4" FIP x 1/8" MIP, 1/Bag	Bl	5	60	\$2.08
930-56161001	3/8" FIP x 1/4" MIP, 1/Bag	Bl	5	60	\$3.16
930-56201601	1/2" FIP x 3/8" MIP, 1/Bag	Bl	5	60	\$2.63



930-56100201

Bar-Stock Caps

Item Number	Item Description	Pkg Type	Min Qty	Case Qty	Price
930-490201	1/8" FIP, 1/Bag	Bl	5	40	\$1.57
930-491001	1/4" FIP, 1/Bag	Bl	5	60	\$1.48
930-491601	3/8" FIP, 1/Bag	Bl	5	60	\$2.24
930-491610	3/8" FIP, 10/Bag	Bl	1	60	\$19.38
930-492001	1/2" FIP, 1/Bag	Bl	5	60	\$3.02
930-492010	1/2" FIP, 10/Bag	Bl	1	10	\$28.34
930-493001	3/4" FIP, 1/Bag	Bl	5	20	\$6.48
930-493010	3/4" FIP, 10/Bag	Bl	1	25	\$64.88

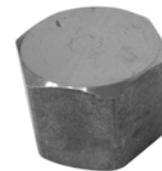

930-490210

Supply

Drainage

Support

Specialties

Appendix

### Bar-Stock Hex Bushings

Item Number	Item Description	Pkg Type	Min Qty	Case Qty	Price
930-15100201	1/4" MIP x 1/8" FIP, 1/Bag	BI	5	60	\$1.62
930-15100210	1/4" MIP x 1/8" FIP, 10/Bag	BI	1	150	\$11.49
930-15160201	3/8" MIP x 1/8" FIP, 1/Bag	BI	5	40	\$2.01
930-15161001	3/8" MIP x 1/4" FIP, 1/Bag	BI	5	60	\$2.01
930-15161010	3/8" MIP x 1/4" FIP, 10/Bag	BI	1	100	\$15.26
930-15200201	1/2" MIP x 1/8" FIP, 1/Bag	BI	5	60	\$3.30
930-15201001	1/2" MIP x 1/4" FIP, 1/Bag	BI	5	60	\$2.84
930-15201601	1/2" MIP x 3/8" FIP, 1/Bag	BI	5	60	\$2.39
930-15201610	1/2" MIP x 3/8" FIP, 10/Bag	BI	1	60	\$21.78
930-15301001	3/4" MIP x 1/4" FIP, 1/Bag	BI	5	60	\$7.15
930-15301601	3/4" MIP x 3/8" FIP, 1/Bag	BI	5	60	\$4.76
930-15302001	3/4" MIP x 1/2" FIP, 1/Bag	BI	5	60	\$4.44
930-15403001	1" MIP x 3/4" FIP, 1/Bag	BI	2	24	\$8.52

### Bar-Stock Face Bushings



930-16161001

Item Number	Item Description	Pkg Type	Min Qty	Case Qty	Price
930-16161001	3/8" MIP x 1/4" FIP, 1/Bag	BI	5	60	\$3.61
930-16302001	3/4" MIP x 1/2" FIP, 1/Bag	BI	5	60	\$4.45

### Bar-Stock Hex Nipples



930-610201

Item Number	Item Description	Pkg Type	Min Qty	Case Qty	Price
930-610201	1/8" MIP x 1/8" MIP, 1/Bag	BI	5	60	\$1.96
930-611001	1/4" MIP x 1/4" MIP, 1/Bag	BI	5	60	\$2.03
930-611601	3/8" MIP x 3/8" MIP, 1/Bag	BI	5	60	\$2.36
930-611610	3/8" MIP x 3/8" MIP, 10/Bag	BI	1	60	\$20.41
930-612001	1/2" MIP x 1/2" MIP, 1/Bag	BI	5	60	\$3.21
930-613001	3/4" MIP x 3/4" MIP, 1/Bag	BI	5	60	\$5.78

### Reducing Hex Nipples



930-62201001

Item Number	Item Description	Pkg Type	Min Qty	Case Qty	Price
930-62201001	1/2" MIP x 1/4" MIP, 1/Bag	BI	5	60	\$4.18
930-62201601	1/2" MIP x 3/8" MIP, 1/Bag	BI	5	60	\$4.57
930-62302001	3/4" MIP x 1/2" MIP, 1/Bag	BI	5	60	\$5.17



**Bar-Stock Ball Valves**

Item Number	Item Description	Pkg Type	Min Qty	Case Qty	Price
996-L100201	1/8" FIP x 1/8" FIP, Leaded, 1/Bag	Bl	5	60	\$41.03
996-L101001	1/4" FIP x 1/4" FIP, Leaded 1/Bag	Bl	5	60	\$41.33



996-L101001

**Bar-Stock Locknuts**

Item Number	Item Description	Pkg Type	Min Qty	Case Qty	Price
930-641001	1/4" FIP, 1/Bag	Bl	5	60	\$2.10
930-642001	1/2" FIP, 1/Bag	Bl	5	20	\$3.15
930-643001	3/4" FIP, 1/Bag	Bl	5	60	\$8.17



930-641001

**Bar-Stock Plugs**

Item Number	Item Description	Pkg Type	Min Qty	Case Qty	Price
<b>SQUARE-HEAD</b>					
930-500201	1/8" MIP, 1/Bag	Bl	5	60	\$1.37
930-501001	1/4" MIP, 1/Bag	Bl	5	60	\$1.64
930-501010	1/4" MIP, 10/Bag	Bl	1	150	\$10.29
930-501601	3/8" MIP, 1/Bag	Bl	5	60	\$1.90
930-502001	1/2" MIP, 1/Bag	Bl	5	60	\$2.74
930-502010	1/2" MIP, 10/Bag	Bl	1	45	\$25.13
930-503001	3/4" MIP, 1/Bag	Bl	5	60	\$4.18
930-504001	1" MIP, 1/Bag	Bl	2	24	\$9.67
930-506001	1-1/2" MIP, 1/Bag	Bl	2	24	\$24.11
<b>HEX-HEAD</b>					
930-510201	1/8" MIP, 1/Bag	Bl	5	60	\$2.30
930-511001	1/4" MIP, 1/Bag	Bl	5	60	\$1.87
930-511601	3/8" MIP, 1/Bag	Bl	5	60	\$2.29
930-512001	1/2" MIP, 1/Bag	Bl	5	60	\$4.00
930-513001	3/4" MIP, 1/Bag	Bl	5	60	\$7.00
<b>ALLEN-HEAD PLUGS</b>					
930-521001	1/4" MIP, 1/Bag	Bl	5	60	\$1.78
930-522001	1/2" MIP, 1/Bag	Bl	5	60	\$3.40
<b>SLOTTED</b>					
930-530201	1/8" MIP, 1/Bag	Bl	5	40	\$4.82



930-501001



930-512001



930-521001



930-530201



# Cast Brass Fittings

**Couplings, Reducing Couplings**

**Union Adapters**

**Tees, Elbows**

**Straight Adapters**

**Caps, Hex Bushings**

**Hex Nipples**

**Locknuts**

**Plugs**





**931-122001**  
Page 701



**931-13100201**  
Page 701



**931-541601**  
Page



**931-202001**  
Page 701



**931-252001**  
Page 702



**931-272001**  
Page 702



**931-562001**  
Page



**931-15200201**  
Page



**931-613001**  
Page



**931-642001**  
Page



**931-503001**  
Page 703

 <b>931-122001</b> Page 701	 <b>931-13100201</b> Page 701	 <b>931-541601</b> Page	 <b>931-202001</b> Page 701	 <b>931-252001</b> Page 702
 <b>931-272001</b> Page 702	 <b>931-562001</b> Page	 <b>931-15200201</b> Page	 <b>931-613001</b> Page	 <b>931-642001</b> Page
 <b>931-503001</b> Page 703				

**Cast Red Brass Couplings**

Item Number	Item Description	Pkg Type	Min Qty	Case Qty	Price
931-122001	1/2" FIP, 1/Bag	Bl	5	60	\$7.57
931-123001	3/4" FIP, 1/Bag	Bl	5	60	\$11.73
931-124001	1" FIP, 1/Bag	Bl	2	24	\$15.07
931-126001	1-1/2" FIP, 1/Bag	Bl	2	24	\$38.31
931-127001	2" FIP, 1/Bag	Bl	2	24	\$65.95



931-122001

**Cast Red Brass Reducing Couplings**

Item Number	Item Description	Pkg Type	Min Qty	Case Qty	Price
931-13100201	1/4" FIP x 1/8" FIP, 1/Bag	Bl	5	60	\$8.27
931-13160201	3/8" FIP x 1/8" FIP, 1/Bag	Bl	5	20	\$8.27
931-13161001	3/8" FIP x 1/4" FIP, 1/Bag	Bl	5	60	\$5.80
931-13200201	1/2" FIP x 1/8" FIP, 1/Bag	Bl	5	60	\$7.00
931-13403001	1" FIP x 3/4" FIP, 1/Bag	Bl	2	24	\$16.70
931-13503001	1-1/4" FIP x 3/4" FIP, 1/Bag	Bl	2	24	\$29.19
931-13604001	1-1/2" FIP x 1" FIP, 1/Bag	Bl	2	24	\$33.31
931-13705001	2" FIP x 1-1/4" FIP, 1/Bag	Bl	2	24	\$51.32
931-13706001	2" FIP x 1-1/2" FIP, 1/Bag	Bl	2	24	\$56.45



931-13100201

**Cast Red Brass Union Adapters**

Item Number	Item Description	Pkg Type	Min Qty	Case Qty	Price
931-542001	1/2" FIP, 1/Bag	Bl	5	60	\$24.06
931-544001	1" FIP, 1/Bag	Bl	2	24	\$44.87
931-545001	1-1/4" FIP, 1/Bag	Bl	2	10	\$56.88
931-546001	1-1/2" FIP, 1/Bag	Bl	2	12	\$88.62
931-547001	2" FIP, 1/Bag	Bl	2	12	\$130.47



931-541601

**Cast Red Brass Tees**

Item Number	Item Description	Pkg Type	Min Qty	Case Qty	Price
931-181601	3/8" FIP, 1/Bag	Bl	5	60	\$8.90
931-200201	1/8" FIP, 1/Bag	Bl	5	20	\$9.84
931-202001	1/2" FIP, 1/Bag	Bl	5	60	\$10.87
931-203001	3/4" FIP, 1/Bag	Bl	5	60	\$16.57
931-204001	1" FIP, 1/Bag	Bl	2	24	\$27.61



931-207001

Supply

Drainage

Support

Specialties

Appendix



931-252001



931-370201



931-272001



931-382001



931-562001

### Cast Red Brass Elbows

Item Number	Item Description	Pkg Type	Min Qty	Case Qty	Price
<b>90°</b>					
931-250201	1/8" FIP, 1/Bag	BI	5	20	\$8.10
931-251001	1/4" FIP, 1/Bag	BI	5	60	\$5.51
931-251601	3/8" FIP, 1/Bag	BI	5	40	\$8.08
931-252001	1/2" FIP, 1/Bag	BI	5	60	\$10.36
931-253001	3/4" FIP, 1/Bag	BI	5	60	\$14.16
931-254001	1" FIP, 1/Bag	BI	2	24	\$19.64
931-25500	1-1/4" FIP, 1/Bag	BI	2	24	\$38.57
931-256001	1-1/2" FIP, 1/Bag	BI	2	12	\$56.82
<b>45°</b>					
931-371601	3/8" FIP, 1/Bag	BI	5	60	\$16.49
931-372001	1/2" FIP, 1/Bag	BI	5	60	\$9.68
931-373001	3/4" FIP, 1/Bag	BI	5	60	\$14.53

### Cast Red Brass Street Elbows

Item Number	Item Description	Pkg Type	Min Qty	Case Qty	Price
<b>90° STREET</b>					
931-270201	1/8" MIP × 1/8" FIP, 1/Bag	BI	5	60	\$10.65
931-272001	1/2" MIP × 1/2" FIP, 1/Bag	BI	5	60	\$10.03
931-273001	3/4" MIP × 3/4" FIP, 1/Bag	BI	5	60	\$14.57
931-274001	1" MIP × 1" FIP, 1/Bag	BI	2	24	\$23.12
931-275001	1-1/4" MIP × 1-1/4" FIP, 1/Bag	BI	2	24	\$45.14
931-277001	2" MIP × 2" FIP, 1/Bag	BI	2	24	\$137.24
<b>45° STREET</b>					
931-382001	1/2" MIP × 1/2" FIP, 1/Bag	BI	5	60	\$9.49
931-383001	3/4" MIP × 3/4" FIP, 1/Bag	BI	5	60	\$14.00

### Cast Red Brass Straight Adapters

#### MIP × FIP

Item Number	Item Description	Pkg Type	Min Qty	Case Qty	Price
931-56100201	1/4" FIP × 1/8" MIP, 1/Bag	BI	5	60	\$14.44
931-56161001	3/8" FIP × 1/4" MIP, 1/Bag	BI	5	60	\$14.71

**Cast Red Brass Caps**

Item Number	Item Description	Pkg Type	Min Qty	Case Qty	Price
931-490201	1/8" FIP, 1/Bag	BI	5	40	\$5.78
931-491001	1/4" FIP, 1/Bag	BI	5	60	\$8.92
931-491601	3/8" FIP, 1/Bag	BI	5	60	\$6.20
931-493001	3/4" FIP, 1/Bag	BI	5	60	\$8.99
931-494001	1" FIP, 1/Bag	BI	2	24	\$17.05
931-497001	2" FIP, 1/Bag	BI	2	24	\$54.05



931-491601

**Cast Red Brass Hex Bushings**

Item Number	Item Description	Pkg Type	Min Qty	Case Qty	Price
931-15302001	3/4" MIP x 1/2" FIP, 1/Bag	BI	5	60	\$6.01
931-15503001	1-1/4" MIP x 3/4" FIP, 1/Bag	BI	2	24	\$18.88
931-15605001	1-1/2" MIP x 1-1/4" FIP, 1/Bag	BI	2	24	\$18.50
931-15705001	2" MIP x 1-1/4" FIP, 1/Bag	BI	2	16	\$34.89



931-15200201

**Cast Red Brass Hex Nipples**

Item Number	Item Description	Pkg Type	Min Qty	Case Qty	Price
931-610201	1/8" MIP, 1/Bag	BI	5	60	\$7.15
931-611001	1/4" MIP, 1/Bag	BI	5	60	\$11.17



931-613001

**Cast Red Brass Locknuts**

Item Number	Item Description	Pkg Type	Min Qty	Case Qty	Price
931-640201	1/8" FIP, 1/Bag	BI	5	60	\$3.34
931-641001	1/4" FIP, 1/Bag	BI	5	60	\$3.37
931-641601	3/8" FIP, 1/Bag	BI	5	60	\$3.52



931-641001

**Cast Red Brass Plugs**

Item Number	Item Description	Pkg Type	Min Qty	Case Qty	Price
<b>SQUARE-HEAD</b>					
931-501010	1/4" MIP, 1/Bag	BI	5	60	\$4.52
931-503001	3/4" MIP, 1/Bag	BI	5	60	\$7.10
931-504001	1" MIP, 1/Bag	BI	5	20	\$9.61
931-505001	1-1/4" MIP, 1/Bag	BI	2	24	\$16.58
931-507001	2" MIP, 1/Bag	BI	2	24	\$31.19



931-502001

**Cast Red Brass Plugs (Cont)**



931-511001

Item Number	Item Description	Pkg Type	Min Qty	Case Qty	Price
<b>HEX-HEAD</b>					
931-510201	1/8" MIP, 1/Bag	BI	5	60	\$3.76
931-511001	1/4" MIP, 1/Bag	BI	5	60	\$2.10
931-513001	3/4" MIP, 1/Bag	BI	5	60	\$15.94

Supply

Drainage

Support

Specialties

Appendix



# Nylon Thread Fittings

**Couplings**

**Bulkhead Union Adapters**

**Tees**

**Elbows**

**Hex Bushings**

**Hex Nipples**

**Plugs**



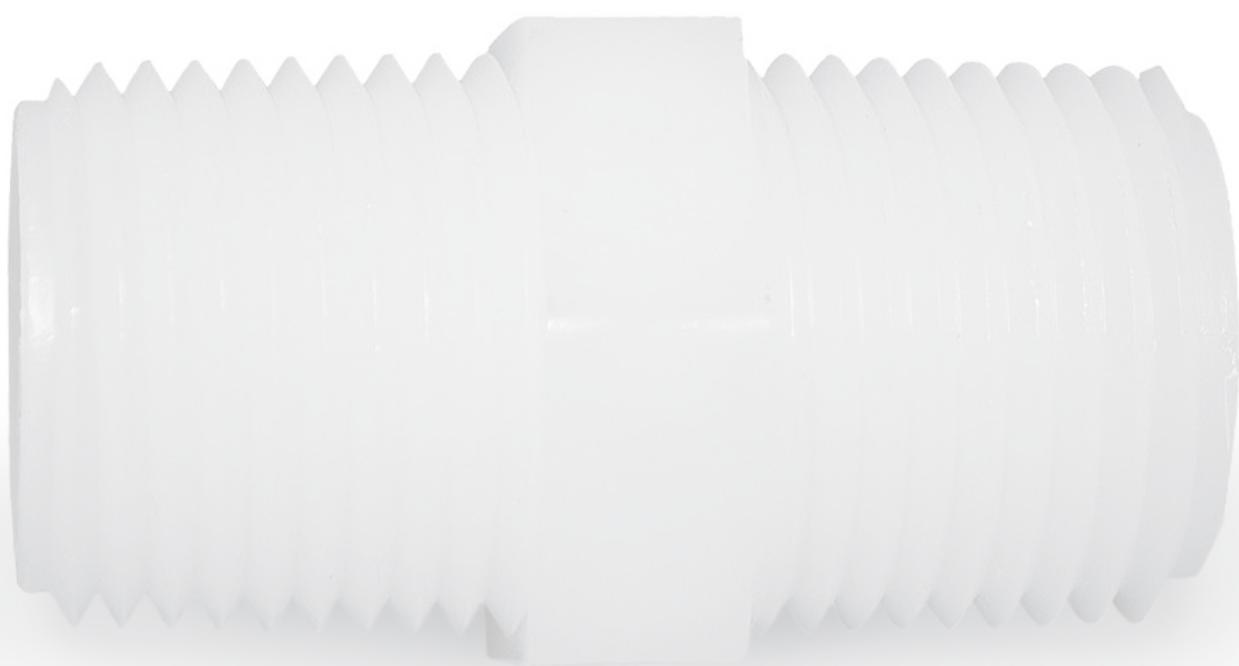

**Nylon Thread Couplings**

Item Number	Item Description	Pkg Type	Min Qty	Case Qty	Price
933-122001	1/2" FIP, 1/Bag	BI	5	60	\$5.79



933-122001

**Thread Bulkhead Union Adapters**

Item Number	Item Description	Pkg Type	Min Qty	Case Qty	Price
<b>NYLON</b>					
933-822001	1/2" FIP W/ Neoprene Washer, 1/Bag	BI	5	60	\$26.13
933-823001	3/4" FIP W/ Neoprene Washer, 1/Bag	BI	5	60	\$15.10
933-833001	3/4" FIP W/ Buna Washer, 1/Bag	BI	5	60	\$21.78
933-842001	1/2" FIP W/ EPDM Washer, 1/Bag	BI	5	60	\$12.20
933-843001	3/4" FIP W/ EPDM Washer, 1/Bag	BI	5	60	\$22.46
933-845001	1-1/4" FIP W/ EPDM Washer, 1/Bag	BI	1	2	\$31.48
<b>POLYPROPYLENE</b>					
933-8320P01	1/2" FIP W/ Buna Washer, 1/Bag	BI	5	60	\$22.79
933-8330P01	3/4" FIP W/ Buna Washer, 1/Bag	BI	5	60	\$24.47
933-8420P01	1/2" FIP W/ EPDM Washer, 1/Bag	BI	5	60	\$23.12
933-8430P01	3/4" FIP W/ EPDM Washer, 1/Bag	BI	5	60	\$24.79
933-8450P01	1-1/4" FIP W/ EPDM Washer, 1/Bag	BI	2	24	\$26.09
933-8460P01	1-1/2" FIP W/ EPDM Washer, 1/Bag	BI	2	24	\$78.74
933-8470P01	2" FIP W/ EPDM Washer, 1/Bag	BI	2	24	\$38.97



933-822001

**Barrel Valve Kits**

Item Number	Item Description	Pkg Type	Min Qty	Case Qty	Price
933-852001	1/2" FIP W/ Neoprene Washer, 1/Bag	BI	1	5	\$17.03
933-853001	3/4" FIP W/ Neoprene Washer, 1/Bag	BI	1	5	\$17.10



933-853001

**Nylon Thread Elbows**

Item Number	Item Description	Pkg Type	Min Qty	Case Qty	Price
933-252001	1/2" FIP, 1/Bag	BI	5	60	\$6.20
933-253001	3/4" FIP, 1/Bag	BI	5	60	\$6.99
933-254001	1" FIP, 1/Bag	BI	2	24	\$12.11



933-253001

Supply

Drainage

Support

Specialties

Appendix



933-15161001



933-611001

### Nylon Thread Hex Bushings

Item Number	Item Description	Pkg Type	Min Qty	Case Qty	Price
933-15201001	1/2" MIP × 1/4" FIP, 1/Bag	BI	5	60	\$2.32
933-15302001	3/4" MIP × 1/2" FIP, 1/Bag	BI	5	60	\$2.42
933-15604001	1-1/2" MIP × 1" FIP, 1/Bag	BI	2	24	\$5.74

### Nylon Thread Hex Nipples

Item Number	Item Description	Pkg Type	Min Qty	Case Qty	Price
933-611001	1/4" MIP, 1/Bag	BI	5	60	\$1.85
933-611601	3/8" MIP, 1/Bag	BI	5	60	\$1.39
933-612001	1/2" MIP, 1/Bag	BI	5	60	\$1.58
933-614001	1" MIP, 1/Bag	BI	5	60	\$2.65

# Pipe Nipples

**Yellow Brass**

**Chrome-Plated**

**Red Brass**





Pipe Nipples - Yellow Brass

Item Number	Item Description	Pkg Type	Min Qty	Case Qty	Price
<b>1/8" MIP</b>					
934-02001	Close, 1/Bag	Bl	5	60	\$2.87
934-021.501	1-1/2" Long, 1/Bag	Bl	5	60	\$2.04
934-02201	2" Long, 1/Bag	Bl	5	40	\$2.22
934-02401	4" Long, 1/Bag	Bl	5	20	\$4.84
<b>1/4" MIP</b>					
934-10001	Close, 1/Bag	Bl	5	60	\$2.47
934-101.501	1-1/2" Long, 1/Bag	Bl	5	60	\$2.42
934-102.501	2-1/2" Long, 1/Bag	Bl	5	60	\$3.76
934-10201	2" Long, 1/Bag	Bl	5	60	\$3.01
934-10301	3" Long, 1/Bag	Bl	5	60	\$3.82
934-10401	4" Long, 1/Bag	Bl	5	60	\$5.80
934-10501	5" Long, 1/Bag	Bl	5	40	\$9.06
<b>3/8" MIP</b>					
934-16001	Close, 1/Bag	Bl	5	60	\$2.44
934-161.501	1-1/2" Long, 1/Bag	Bl	5	60	\$3.13
934-162.501	2-1/2" Long, 1/Bag	Bl	5	20	\$4.70
934-16201	2" Long, 1/Bag	Bl	5	40	\$3.91
934-16301	3" Long, 1/Bag	Bl	5	20	\$6.06
934-16401	4" Long, 1/Bag	Bl	5	20	\$9.87
934-16601	6" Long, 1/Bag	Bl	5	60	\$13.75
<b>1/2" MIP</b>					
934-20001	Close, 1/Bag	Bl	5	60	\$3.06
934-201.501	1-1/2" Long, 1/Bag	Bl	5	60	\$3.08
934-202.501	2-1/2" Long, 1/Bag	Bl	5	60	\$5.48
934-20201	2" Long, 1/Bag	Bl	5	60	\$4.59
934-203.501	3-1/2" Long, 1/Bag	Bl	5	60	\$7.20
934-20301	3" Long, 1/Bag	Bl	5	60	\$6.92
934-204.501	4-1/2" Long, 1/Bag	Bl	5	60	\$15.09
934-20401	4" Long, 1/Bag	Bl	5	60	\$13.08
934-205.501	5-1/2" Long, 1/Bag	Bl	5	60	\$18.09
934-20501	5" Long, 1/Bag	Bl	5	60	\$18.09
934-20601	6" Long, 1/Bag	Bl	5	60	\$20.43
<b>3/4" MIP</b>					
934-30001	Close, 1/Bag	Bl	5	60	\$4.13
934-301.501	1-1/2" Long, 1/Bag	Bl	5	60	\$7.71
934-302.501	2-1/2" Long, 1/Bag	Bl	5	60	\$13.87
934-30201	2" Long, 1/Bag	Bl	5	60	\$11.00
934-30301	3" Long, 1/Bag	Bl	5	60	\$18.09
934-30401	4" Long, 1/Bag	Bl	5	40	\$18.76
934-30501	5" Long, 1/Bag	Bl	5	60	\$26.13
934-30601	6" Long, 1/Bag	Bl	5	60	\$28.80
<b>1" MIP</b>					
934-40001	Close, 1/Bag	Bl	2	24	\$13.41
934-402.501	2-1/2" Long, 1/Bag	Bl	2	24	\$23.12
934-40201	2" Long, 1/Bag	Bl	2	24	\$18.09
934-40401	4" Long, 1/Bag	Bl	2	24	\$26.48



934-021.501



934-102.501



934-163.501



934-40201

Supply

Drainage

Support

Specialties

Appendix

**Pipe Nipples - Chrome-Plated Yellow Brass**

Item Number	Item Description	Pkg Type	Min Qty	Case Qty	Price
<b>3/8" MIP</b>					
936-16001	Close, 1/Bag	BI	5	60	\$8.29
936-16201	2" Long, 1/Bag	BI	5	60	\$11.64
936-16301	3" Long, 1/Bag	BI	5	60	\$15.24
936-16401	4" Long, 1/Bag	BI	5	60	\$19.38
936-16501	5" Long, 1/Bag	BI	5	60	\$22.53
936-16601	6" Long, 1/Bag	BI	5	60	\$26.36
<b>1/2" MIP</b>					
936-20001	Close, 1/Bag	BI	5	60	\$10.88
936-201.501	1-1/2" Long, 1/Bag	BI	5	60	\$12.48
936-20201	2" Long, 1/Bag	BI	5	60	\$14.53
936-203.501	3-1/2" Long, 1/Bag	BI	5	60	\$22.77
936-20301	3" Long, 1/Bag	BI	5	60	\$20.04
936-20401	4" Long, 1/Bag	BI	5	60	\$20.56
936-20501	5" Long, 1/Bag	BI	5	60	\$30.96

**Pipe Nipples - Red Brass**

Item Number	Item Description	Pkg Type	Min Qty	Case Qty	Price
<b>1/8" MIP</b>					
935-02001	Close, 1/Bag	BI	5	60	\$3.91
935-022.501	2-1/2" Long, 1/Bag	BI	5	20	\$5.27
935-02301	3" Long, 1/Bag	BI	5	20	\$5.74
935-02401	4" Long, 1/Bag	BI	5	20	\$6.72
935-02501	5" Long, 1/Bag	BI	5	60	\$7.93
935-02601	6" Long, 1/Bag	BI	5	60	\$9.96
<b>1/4" MIP</b>					
935-10001	Close, 1/Bag	BI	5	60	\$4.46
935-102.501	2-1/2" Long, 1/Bag	BI	5	60	\$6.04
935-10201	2" Long, 1/Bag	BI	5	60	\$5.62
<b>3/8" MIP</b>					
935-161.501	1-1/2" Long, 1/Bag	BI	5	60	\$5.32
935-162.501	2-1/2" Long, 1/Bag	BI	5	20	\$7.37
935-16301	3" Long, 1/Bag	BI	5	20	\$8.12
935-16501	5" Long, 1/Bag	BI	5	60	\$12.33
935-16601	6" Long, 1/Bag	BI	5	60	\$14.80
<b>1/2" MIP</b>					
935-20001	Close, 1/Bag	BI	5	60	\$6.11
935-202.501	2-1/2" Long, 1/Bag	BI	5	60	\$9.66
<b>3/4" MIP</b>					
935-30001	Close, 1/Bag	BI	5	60	\$8.20
935-30301	3" Long, 1/Bag	BI	5	60	\$14.68
<b>1" MIP</b>					
935-40201	2" Long, 1/Bag	BI	2	24	\$14.79
935-40301	3" Long, 1/Bag	BI	2	24	\$20.59
935-40601	6" Long, 1/Bag	BI	2	24	\$35.96
<b>1-1/4" MIP</b>					
935-50301	3" Long, 1/Bag	BI	2	24	\$29.18

Supply

Drainage

Support

Specialties

Appendix



936-16201



936-20201



935-201.501



935-40201



935-50401



**Pipe Nipples - Red Brass (Cont)**

Item Number	Item Description	Pkg Type	Min Qty	Case Qty	Price
	<b>2" MIP</b>				
935-70401	4" Long, 1/Bag	Bl	2	24	\$60.22



935-70301

Supply

Drainage

Support

Specialties

Appendix



# Polypro Push Fittings

**Couplings**

**Elbows**

**Tees**

**Straight Adapters**

**Elbow Adapters**

**Valves**



Polypro push fittings offer a fast, easy connection for copper, polyethylene, and PEX tubing in cold-water applications.

**Note:** Do Not expose polypro push fittings to volatile organic compounds (VOCs) or caustic chemicals. Do Not use with vinly tubing.



### Polypropylene Push-Fit Couplings

· For cold-water applications only. Do Not use with vinyl tube.

Item Number	Item Description	Pkg Type	Min Qty	Case Qty	Price
645QK0	1/4" OD PF, 1/Bag	BI	5	60	\$3.57
645QK1	3/8" OD PF, 1/Bag	BI	5	60	\$5.72
645QK2	1/2" OD PF, 1/Bag	BI	5	60	\$6.46
645QK9	5/16" OD PF, 1/Bag	BI	5	60	\$6.46
<b>REDUCING</b>					
645QK10	3/8 OD PF × 1/4" OD PF, 1/Bag	BI	5	60	\$5.72
645QK90	5/16" OD PF × 1/4" OD PF, 1/Bag	BI	5	60	\$6.46



645QK1

### Polypropylene Push-Fit Elbows

· For cold-water applications only. Do Not use with vinyl tube.

Item Number	Item Description	Pkg Type	Min Qty	Case Qty	Price
642QK0	1/4" OD PF, 1/Bag	BI	5	60	\$3.44
642QK1	3/8" PF, 1/Bag	BI	5	60	\$3.63



642QK1

### Polypropylene Push-Fit Tees

· For cold-water applications only. Do Not use with vinyl tube.

Item Number	Item Description	Pkg Type	Min Qty	Case Qty	Price
641QK000	1/4" OD PF, 1/Bag	BI	5	60	\$6.39
641QK111	3/8" OD PF, 1/Bag	BI	5	60	\$7.81
641QK222	1/2" OD PF, 1/Bag	BI	5	60	\$9.23



641QK222

### Polypropylene Push-Fit Straight Adapters

· For cold-water applications only. Do Not use with vinyl tube.

Item Number	Item Description	Pkg Type	Min Qty	Case Qty	Price
<b>MIP</b>					
646QK0	1/4" OD PF × 1/4 MIP, 1/Bag	BI	5	60	\$3.05
646QK01	3/8" OD PF × 1/4 MIP, 1/Bag	BI	5	60	\$3.18
646QK1	3/8" OD PF × 3/8" MIP, 1/Bag	BI	5	60	\$3.35
646QK10	1/4" OD PF × 3/8" MIP, 1/Bag	BI	5	60	\$3.35
646QK12	1/2" OD PF × 3/8" MIP, 1/Bag	BI	5	60	\$4.46
646QK2	1/2" OD PF × 1/2" MIP, 1/Bag	BI	5	60	\$4.46
646QK20	1/4" OD PF × 1/2" MIP, 1/Bag	BI	5	60	\$4.09
646QK21	3/8" OD PF × 1/2" MIP, 1/Bag	BI	5	60	\$4.09
646QK80	1/4" OD PF × 1/8" MIP, 1/Bag	BI	5	60	\$3.72
646QK81	3/8" OD PF × 1/8" MIP, 1/Bag	BI	5	60	\$5.59



646QK2

**Polypropylene Push-Fit Straight Adapters (Cont)**

Item Number	Item Description	Pkg Type	Min Qty	Case Qty	Price
<b>FIP</b>					
647QK0	1/4" OD PF × 1/4" FIP, 1/Bag	BI	5	60	\$5.23
647QK10	3/8" OD PF × 1/4" FIP, 1/Bag	BI	5	60	\$5.23

**Polypropylene Push-Fit Elbow Adapters**

**MIP**

· For cold-water applications only. Do Not use with vinyl tube.



632QK221M

Item Number	Item Description	Pkg Type	Min Qty	Case Qty	Price
632QK000M	1/4" OD PF × 1/4 MIP, 1/Bag	BI	5	60	\$4.81
632QK002M	1/4" OD PF × 1/2" MIP, 1/Bag	BI	5	60	\$5.09
632QK110M	3/8" OD PF × 1/4 MIP, 1/Bag	BI	5	60	\$5.65
632QK111M	3/8" OD PF × 3/8" MIP, 1/Bag	BI	5	60	\$7.06
632QK221M	1/2" OD PF × 3/8" MIP, 1/Bag	BI	5	60	\$7.06
632QK222M	1/2" OD PF × 1/2" MIP, 1/Bag	BI	5	60	\$7.06

**Polypropylene Push-Fit Valves**

· For cold-water applications only. Do Not use with vinyl tube.



637QK980M

Item Number	Item Description	Pkg Type	Min Qty	Case Qty	Price
<b>PF × PF</b>					
637QK900	1/4" OD PF × 1/4" OD PF, 1/Bag	BI	5	60	\$14.14
637QK911	3/8" OD PF × 3/8" OD PF, 1/Bag	BI	5	60	\$14.93
<b>PF × MIP</b>					
637QK911M	3/8" OD PF × 3/8" MIP, 1/Bag	BI	5	60	\$13.99
637QK980M	1/4" OD PF × 1/8" MIP, 1/Bag	BI	5	60	\$13.24

Supply

Drainage

Support

Specialties

Appendix

# **Brass Hose Barb Fittings**

**Couplings**

**Elbows**

**Straight Adapters**

**Ferrules**

**Valves**







Brass Hose Barb Couplings

Item Number	Item Description	Pkg Type	Min Qty	Case Qty	Price
903-120201	1/8" Barb, 1/Bag	Bl	5	60	\$1.99
903-120501	3/16" Barb, 1/Bag	Bl	5	60	\$2.10
903-121001	1/4" Barb, 1/Bag	Bl	5	60	\$1.86
903-121501	5/16" Barb, 1/Bag	Bl	5	60	\$2.04
903-121601	3/8" Barb, 1/Bag	Bl	5	60	\$2.13
903-122001	1/2" Barb, 1/Bag	Bl	5	60	\$2.42
903-122501	5/8" Barb, 1/Bag	Bl	5	40	\$4.03
903-123301	7/8" Barb, 1/Bag	Bl	5	60	\$6.94



903-122001

Brass Hose Barb Straight Adapters

MIP

Item Number	Item Description	Pkg Type	Min Qty	Case Qty	Price
<b>1/8" BARB</b>					
903-400201	1/8" Barb x 1/8" MIP, 1/Bag	Bl	5	60	\$1.70
903-41021001	1/8" Barb x 1/4" MIP, 1/Bag	Bl	5	60	\$4.67
<b>3/16" BARB</b>					
903-41050201	3/16" Barb x 1/8" MIP, 1/Bag	Bl	5	60	\$2.68
903-41051001	3/16" Barb x 1/4" MIP, 1/Bag	Bl	5	60	\$2.02
<b>1/4" BARB</b>					
903-401001	1/4" Barb x 1/4" MIP, 1/Bag	Bl	5	60	\$2.20
903-41100201	1/4" Barb x 1/8" MIP, 1/Bag	Bl	5	60	\$2.53
903-41101601	1/4" Barb x 3/8" MIP, 1/Bag	Bl	5	60	\$2.75
903-41102001	1/4" Barb x 1/2" MIP, 1/Bag	Bl	5	60	\$3.99
<b>5/16" BARB</b>					
903-41150201	5/16" Barb x 1/8" MIP, 1/Bag	Bl	5	60	\$2.12
903-41151001	5/16" Barb x 1/4" MIP, 1/Bag	Bl	5	60	\$2.73
903-41151601	5/16" Barb x 3/8" MIP, 1/Bag	Bl	5	60	\$4.60
<b>3/8" BARB</b>					
903-401601	3/8" Barb x 3/8" MIP, 1/Bag	Bl	5	60	\$3.10
903-41161001	3/8" Barb x 1/4" MIP, 1/Bag	Bl	5	60	\$2.77
903-41162001	3/8" Barb x 1/2" MIP, 1/Bag	Bl	5	60	\$3.94
<b>1/2" BARB</b>					
903-402001	1/2" Barb x 1/2" MIP, 1/Bag	Bl	5	60	\$4.70
903-41201001	1/2" Barb x 1/4" MIP, 1/Bag	Bl	5	60	\$3.64
903-41201601	1/2" Barb x 3/8" MIP, 1/Bag	Bl	5	60	\$3.95
903-41203001	1/2" Barb x 3/4" MIP, 1/Bag	Bl	5	60	\$6.22
<b>5/8" BARB</b>					
903-41251601	5/8" Barb x 3/8" MIP, 1/Bag	Bl	5	60	\$4.02
903-41252001	5/8" Barb x 1/2" MIP, 1/Bag	Bl	5	60	\$5.11
903-41253001	5/8" Barb x 3/4" MIP, 1/Bag	Bl	5	60	\$8.27
<b>3/4" BARB</b>					
903-403001	3/4" Barb x 3/4" MIP, 1/Bag	Bl	5	60	\$6.37
903-41302001	3/4" Barb x 1/2" MIP, 1/Bag	Bl	5	60	\$5.86
<b>1" BARB</b>					
903-404001	1" Barb x 1" MIP, 1/Bag	Bl	5	60	\$12.03



903-401601

Supply

Drainage

Support

Specialties

Appendix

**Brass Hose Barb Straight Adapters**

**FIP**



903-442001



903-461601

Item Number	Item Description	Pkg Type	Min Qty	Case Qty	Price
<b>1/8" BARB</b>					
903-45021001	1/8" Barb × 1/4" FIP, 1/Bag	BI	5	40	\$4.92
<b>3/16" BARB</b>					
903-45051001	3/16" Barb × 1/4" FIP, 1/Bag	BI	5	60	\$5.26
<b>1/4" BARB</b>					
903-441001	1/4" Barb × 1/4" FIP, 1/Bag	BI	5	60	\$3.66
903-45100201	1/4" Barb × 1/8" FIP, 1/Bag	BI	5	60	\$2.97
<b>5/16" BARB</b>					
903-45151001	5/16" Barb × 1/4" FIP, 1/Bag	BI	5	60	\$2.98
<b>3/8" BARB</b>					
903-441601	3/8" Barb × 3/8" FIP, 1/Bag	BI	5	60	\$4.55
903-45161001	3/8" Barb × 1/4" FIP, 1/Bag	BI	5	60	\$2.89
903-45162001	3/8" Barb × 1/2" FIP, 1/Bag	BI	5	60	\$6.11
<b>1/2" BARB</b>					
903-442001	1/2" Barb × 1/2" FIP, 1/Bag	BI	5	60	\$4.07
903-45201601	1/2" Barb × 3/8" FIP, 1/Bag	BI	5	60	\$7.09
<b>3/8" BARB SWIVEL ADAPTER</b>					
903-461601	3/8" Barb × 3/8" FIP Swivel, 1/Bag	BI	5	60	\$5.47

**Brass Hose Barb Ferrule**



903-L99531

Item Number	Item Description	Pkg Type	Min Qty	Case Qty	Price
903-L99531	.531 I.D., Brass, 50/Bag	B	1	5	\$28.10
903-L99560	.562 I.D., Brass, 50/Bag	B	1	5	\$33.58
903-L99625	.625 I.D., Brass, 50/Bag	B	1	5	\$38.91
903-L99656	.656 I.D., Brass, 50/Bag	B	1	5	\$33.58
903-L99690	.687 I.D., Brass, 50/Bag	B	1	5	\$38.91
903-L99812	.812 I.D., Brass, 50/Bag	B	1	4	\$38.84

**Brass Hose Barb Valves**



996-L601601

Item Number	Item Description	Pkg Type	Min Qty	Case Qty	Price
<b>LEADED BRASS</b>					
996-L601001	1/4" × 1/4" Barb Ball Valve, Leaded, 1/Bag	BI	5	60	\$39.74
996-L601601	3/8" × 3/8" Barb Ball Valve, Leaded, 1/Bag	BI	5	60	\$43.38

Supply

Drainage

Support

Specialties

Appendix

# **Nylon Hose Barb Fittings**

**Couplings**

**Reducing Couplings**

**Elbows**

**Tees**

**Straight Adapters**

**Elbow Adapters**





**904-123001**  
Page 725



**904-13201601**  
Page 725



**904-25101**  
Page 725



**904-200201**  
Page 725



**904-41162001**  
Page 726



**904-271001**  
Page 727

**Nylon Hose Barb Couplings**

Item Number	Item Description	Pkg Type	Min Qty	Case Qty	Price
904-120201	1/8" Barb, 1/Bag	Bl	5	60	\$2.08
904-120501	3/16" Barb, 1/Bag	Bl	5	60	\$1.56
904-121001	1/4" Barb, 1/Bag	Bl	5	60	\$1.63
904-121501	5/16" Barb, 1/Bag	Bl	5	60	\$1.61
904-121601	3/8" Barb, 1/Bag	Bl	5	60	\$1.34
904-122001	1/2" Barb, 1/Bag	Bl	5	60	\$1.40
904-122501	5/8" Barb, 1/Bag	Bl	5	60	\$1.56
904-123001	3/4" Barb, 1/Bag	Bl	5	60	\$1.98
904-124001	1" Barb, 1/Bag	Bl	5	60	\$2.54
904-125001	1-1/4" Barb, 1/Bag	Bl	2	24	\$4.10
904-126001	1-1/2" Barb, 1/Bag	Bl	2	24	\$4.32
904-127001	2" Barb, 1/Bag	Bl	1	4	\$14.57



904-125001

**Nylon Hose Barb Reducing Couplings**

Item Number	Item Description	Pkg Type	Min Qty	Case Qty	Price
904-13100501	1/4" x 3/16" Barb, 1/Bag	Bl	5	60	\$1.47
904-13161001	3/8" x 1/4" Barb, 1/Bag	Bl	5	60	\$1.46
904-13201601	1/2" x 3/8" Barb, 1/Bag	Bl	5	60	\$1.47
904-13252001	5/8" x 1/2" Barb, 1/Bag	Bl	5	60	\$1.74



904-13201601

**Nylon Hose Barb Elbows**

Item Number	Item Description	Pkg Type	Min Qty	Case Qty	Price
904-25101	1/4" Barb, 1/Bag	Bl	5	60	\$2.02
904-251601	3/8" Barb, 1/Bag	Bl	5	60	\$2.02
904-252001	1/2" Barb, 1/Bag	Bl	5	60	\$2.02
904-252501	5/8" Barb, 1/Bag	Bl	5	60	\$2.45
904-253001	3/4" Barb, 1/Bag	Bl	5	60	\$2.42
904-254001	1" Barb, 1/Bag	Bl	5	60	\$3.56



904-25101

**Nylon Hose Barb Tees**

Item Number	Item Description	Pkg Type	Min Qty	Case Qty	Price
<b>STANDARD TEE</b>					
904-200201	1/8" Barb, 1/Bag	Bl	5	60	\$2.17
904-200501	3/16" Barb, 1/Bag	Bl	5	60	\$2.00
904-201001	1/4" Barb, 1/Bag	Bl	5	60	\$2.16
904-201601	3/8" Barb, 1/Bag	Bl	5	60	\$1.95
904-202000	1/2" Barb, 100/Bag	B	1	1	\$175.63
904-202001	1/2" Barb, 1/Bag	Bl	5	60	\$2.14
904-202501	5/8" Barb, 1/Bag	Bl	5	60	\$2.16
904-203001	3/4" Barb, 1/Bag	Bl	5	60	\$2.67
904-204001	1" Barb, 1/Bag	Bl	5	60	\$3.57



904-200201

Supply

Drainage

Support

Specialties

Appendix

**Nylon Hose Barb Tees (Cont)**



904-2120203001

Item Number	Item Description	Pkg Type	Min Qty	Case Qty	Price
<b>REDUCING TEE</b>					
904-22161001	3/8" × 3/8" × 1/4" Barb, 1/Bag	BI	5	60	\$2.38
904-22201601	1/2" × 1/2" × 3/8" Barb, 1/Bag	BI	5	60	\$2.38
<b>BULLHEAD TEE</b>					
904-22162001	3/8" × 3/8" × 1/2" Barb, 1/Bag	BI	5	60	\$2.56

**Nylon Hose Barb Straight Adapters**

**MIP**



904-41162001



904-404001

Item Number	Item Description	Pkg Type	Min Qty	Case Qty	Price
<b>3/16" BARB</b>					
904-41050201	3/16" Barb × 1/8" MIP, 1/Bag	BI	5	60	\$1.50
904-41051001	3/16" Barb × 1/4" MIP, 1/Bag	BI	5	60	\$1.46
<b>1/4" BARB</b>					
904-401001	1/4" Barb × 1/4" MIP, 1/Bag	BI	5	60	\$1.35
904-41100101	1/4" Barb × 1/8" MIP, 1/Bag	BI	5	60	\$1.42
904-41101601	1/4" Barb × 3/8" MIP, 1/Bag	BI	5	60	\$1.56
904-41102001	1/4" Barb × 1/2" MIP, 1/Bag	BI	5	60	\$1.61
<b>5/16" BARB</b>					
904-41151001	5/16" Barb × 1/4" MIP, 1/Bag	BI	5	60	\$1.46
<b>3/8" BARB</b>					
904-401601	3/8" Barb × 3/8" MIP, 1/Bag	BI	5	60	\$1.53
904-41160201	3/8" Barb × 1/8" MIP, 1/Bag	BI	5	60	\$1.46
904-41161001	3/8" Barb × 1/4" MIP, 1/Bag	BI	5	60	\$1.82
904-41162001	3/8" Barb × 1/2" MIP, 1/Bag	BI	5	60	\$1.61
904-41163001	3/8" Barb × 3/4" MIP, 1/Bag	BI	5	60	\$1.76
<b>1/2" BARB</b>					
904-402001	1/2" Barb × 1/2" MIP, 1/Bag	BI	5	60	\$1.50
904-41201001	1/2" Barb × 1/4" MIP, 1/Bag	BI	5	60	\$1.46
904-41201601	1/2" Barb × 3/8" MIP, 1/Bag	BI	5	60	\$1.49
904-41203001	1/2" Barb × 3/4" MIP, 1/Bag	BI	5	60	\$1.95
<b>5/8" BARB</b>					
904-41251601	5/8" Barb × 3/8" MIP, 1/Bag	BI	5	60	\$1.50
904-41252001	5/8" Barb × 1/2" MIP, 1/Bag	BI	5	60	\$1.75
904-41253001	5/8" Barb × 3/4" MIP, 1/Bag	BI	5	60	\$1.88
<b>3/4" BARB</b>					
904-403001	3/4" Barb × 3/4" MIP, 1/Bag	BI	5	60	\$1.83
904-41302001	3/4" Barb × 1/2" MIP, 1/Bag	BI	5	60	\$1.83
904-41304001	3/4" Barb × 1" MIP, 1/Bag	BI	5	60	\$2.19
<b>1" BARB</b>					
904-404001	1" Barb × 1" MIP, 1/Bag	BI	5	60	\$2.38
904-41403001	1" Barb × 3/4" MIP, 1/Bag	BI	5	60	\$2.20
<b>1-1/4" BARB</b>					
904-405001	1-1/4" Barb × 1-1/4" MIP, 1/Bag	BI	4	4	\$5.11
<b>2" BARB</b>					
904-407001	2" Barb × 2" MIP, 1/Bag	BI	1	4	\$8.20

Supply

Drainage

Support

Specialties

Appendix

**Nylon Hose Barb Straight Adapters**

**FIP**

Item Number	Item Description	Pkg Type	Min Qty	Case Qty	Price
904-457001	2" Barb x 2" FIP, 1/Bag	BI	1	4	\$9.04



904-457001

**Nylon Hose Barb Elbow Adapters**

**MIP**

Item Number	Item Description	Pkg Type	Min Qty	Case Qty	Price
<b>1/4" BARB</b>					
904-271001	1/4" Barb x 1/4" MIP, 1/Bag	BI	5	60	\$1.81
904-28101601	1/4" Barb x 3/8" MIP, 1/Bag	BI	5	60	\$2.21
<b>3/8" BARB</b>					
904-271601	3/8" Barb x 3/8" MIP, 1/Bag	BI	5	60	\$1.77
904-28161001	3/8" Barb x 1/4" MIP, 1/Bag	BI	5	60	\$1.98
904-28162001	3/8" Barb x 1/2" MIP, 1/Bag	BI	5	60	\$2.12
904-28163001	3/8" Barb x 3/4" MIP, 1/Bag	BI	5	60	\$2.65
<b>1/2" BARB</b>					
904-272001	1/2" Barb x 1/2" MIP, 1/Bag	BI	5	60	\$2.03
904-28201001	1/2" Barb x 1/4" MIP, 1/Bag	BI	5	60	\$2.07
904-28201601	1/2" Barb x 3/8" MIP, 1/Bag	BI	5	60	\$2.04
904-28203001	1/2" Barb x 3/4" MIP, 1/Bag	BI	5	60	\$2.48
<b>5/8" BARB</b>					
904-28252001	5/8" Barb x 1/2" MIP, 1/Bag	BI	5	60	\$2.46
904-28253001	5/8" Barb x 3/4" MIP, 1/Bag	BI	5	60	\$2.70
<b>3/4" BARB</b>					
904-273001	3/4" Barb x 3/4" MIP, 1/Bag	BI	5	60	\$2.47
904-28302001	3/4" Barb x 1/2" MIP, 1/Bag	BI	5	60	\$2.52
904-28304001	3/4" Barb x 1" MIP, 1/Bag	BI	5	60	\$2.65
<b>1" BARB</b>					
904-28403001	1" Barb x 3/4" MIP, 1/Bag	BI	5	60	\$3.17



904-28102001

Supply

Drainage

Support

Specialties

Appendix





# **Brass Garden Hose Fittings**

**Couplings**

**Elbows**

**Straight Adapters**

**Elbow Adapters**

**Cap, Wye**

**Blowout Fittings**

**Washers**





**937-7130101**  
Page 731



**937-803030201**  
Page 731



**937-6730101**  
Page 731



**937-6930101**  
Page 731



**937-65303001**  
Page 732



**937-793002201**  
Page 732

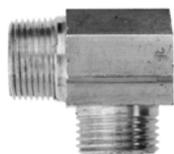

**937-273030101**  
Page



**937-4930101**  
Page 732



**937-2330101**  
Page 732



**937-96301001**  
Page 733



**291-30500**  
Page 733



**938-713030101**  
Page 737



**938-673030101**  
Page 737



**938-693030101**  
Page 737



**938-65303000**  
Page



**938-4930101**  
Page 738

**Brass Garden Hose Couplings**

Item Number	Item Description	Pkg Type	Min Qty	Case Qty	Price
937-1230201	3/4" FHT Swivel Coupling, 1/Bag	BI	5	60	\$7.08
937-123030101	3/4" FHT, 1/Bag	BI	5	60	\$4.54
937-7130101	3/4" MHT, 1/Bag	BI	5	60	\$5.75



937-7130101

**Brass Garden Hose Elbow**

Item Number	Item Description	Pkg Type	Min Qty	Case Qty	Price
937-803030201	3/4" FHT Swivel x 3/4" MHT, 1/Bag	BI	5	20	\$13.66



937-803030201

**Brass Garden Hose Straight Adapters**

**MIP**

Item Number	Item Description	Pkg Type	Min Qty	Case Qty	Price
<b>MHT x MIP</b>					
937-6730101	3/4" MHT x 3/4" MIP, 1/Bag	BI	5	60	\$5.20
937-67303020101	3/4" MHT x 3/4" MIP (1/2" FIP ID), 1/Bag	BI	5	60	\$7.71
937-683020101	3/4" MHT x 1/2" MIP, 1/Bag	BI	5	60	\$4.20
<b>FHT x MIP WITH RUBBER WASHER</b>					
937-7230101	3/4" FHT x 3/4" MIP w/ 1/2" FIP Tap, 1/Bag	BI	5	60	\$6.85
937-723030101	3/4" FHT x 3/4" MIP, 1/Bag	BI	5	60	\$10.39
937-733020101	3/4" FHT x 1/2" MIP, 1/Bag	BI	5	60	\$6.08



937-7230101

**Brass Garden Hose Straight Adapters**

**FIP**

Item Number	Item Description	Pkg Type	Min Qty	Case Qty	Price
<b>MHT x FIP</b>					
937-6930101	3/4" MHT x 3/4" FIP, 1/Bag	BI	5	60	\$4.08
937-703020101	3/4" MHT x 1/2" FIP, 1/Bag	BI	5	60	\$3.58
<b>FHT x FIP WITH RUBBER WASHER</b>					
937-7530101	3/4" FHT x 3/4" FIP, 1/Bag	BI	5	40	\$5.20
937-753030201	3/4" FHT x 3/4" FIP Swivel, 1/Bag	BI	5	60	\$7.09
937-763002101	3/4" FHT x 1/8" FIP, 1/Bag	BI	5	20	\$10.11
937-763020101	3/4" FHT x 1/2" FIP, 1/Bag	BI	5	60	\$4.77
937-763020201	3/4" FHT x 1/2" FIP Swivel, 1/Bag	BI	5	60	\$6.29



937-6930101



937-753030201

Supply



937-65303001

Drainage



937-773030101

Support

### Brass Garden Hose Straight Adapters

#### Hose Barb

Item Number	Item Description	Pkg Type	Min Qty	Case Qty	Price
<b>MHT × HOSE BARB</b>					
937-65303001	3/4" MHT × 3/4" Barb, 1/Bag	BI	5	60	\$6.48
937-66302001	3/4" MHT × 1/2" Barb, 1/Bag	BI	5	40	\$5.79
937-66302501	3/4" MHT × 5/8" Barb, 1/Bag	BI	5	20	\$5.28
<b>MACHINED FHT × HOSE BARB</b>					
937-773030101	3/4" FHT × 3/4" ID Barb, Swivel, 1/Bag	BI	5	40	\$4.75
937-782030101	3/4" FHT × 1/2" ID Barb, Swivel, 1/Bag	BI	5	40	\$8.09
937-782530101	3/4" FHT × 5/8" ID Barb, Swivel, 1/Bag	BI	5	40	\$10.91
937-8520300201	3/4" FHT × 3/8" ID Barb, Swivel, 1/Bag	BI	5	40	\$12.67
<b>STAMPED FHT X HOSE BARB</b>					
937-783016201	3/4" FHT × 3/8" ID Barb, Swivel, 1/Bag	BI	5	60	\$8.87
937-783020201	3/4" FHT × 1/2" ID Barb, Swivel, 1/Bag	BI	5	40	\$9.48

### Brass Garden Hose Straight Adapters

#### Compression

Item Number	Item Description	Pkg Type	Min Qty	Case Qty	Price
937-793002201	3/4" FHT × 1/4" OD Comp, Swivel, 1/Bag	BI	5	60	\$8.05

Specialties



937-793002201

Appendix



937-4930101

### Brass Garden Hose Cap

Item Number	Item Description	Pkg Type	Min Qty	Case Qty	Price
937-4930100	3/4" FHT, Stamped, 1/Bag	BI	5	60	\$4.23
937-4930101	3/4" FHT, Machined, 1/Bag	BI	5	60	\$5.66

### Brass Garden Hose Wye

Item Number	Item Description	Pkg Type	Min Qty	Case Qty	Price
937-2330101	3/4" FHT × 3/4" MHT × 3/4" MHT, 1/Bag	BI	5	20	\$9.61



937-2330101

**Brass Garden Hose Blowout Fittings**

Item Number	Item Description	Pkg Type	Min Qty	Case Qty	Price
937-95301001	3/4" MHT x 1/4" Air I/M, 1/Bag	BI	5	60	\$14.48
937-96301001	3/4" FHT x 1/4" Air I/M w/ Rubber Washer, 1/Bag	BI	5	60	\$15.03



937-96301001

**Brass Garden Hose Washer**

Item Number	Item Description	Pkg Type	Min Qty	Case Qty	Price
291-30500	3/4" Garden Hose Washer	B	12	240	\$0.35



291-30500

Supply

Drainage

Support

Specialties

Appendix



# **Nylon Garden Hose Fittings**

**Couplings**

**Straight Adapters**

**Cap**







**Nylon Garden Hose Couplings**

Item Number	Item Description	Pkg Type	Min Qty	Case Qty	Price
938-1230101	3/4" FHT, 1/Bag	BI	5	60	\$9.04
938-713030101	3/4" MHT, 1/Bag	BI	5	60	\$3.05



938-713030101

**Nylon Garden Hose Straight Adapters**

**MIP**

Item Number	Item Description	Pkg Type	Min Qty	Case Qty	Price
<b>MHT × MIP</b>					
938-673030101	3/4" MHT × 3/4" MIP, 1/Bag	BI	5	60	\$4.70
938-683020101	3/4" MHT × 1/2" MIP, 1/Bag	BI	5	60	\$2.75



938-673030101

**Nylon Garden Hose Straight Adapters**

**FIP**

Item Number	Item Description	Pkg Type	Min Qty	Case Qty	Price
<b>MHT × FIP</b>					
938-693030101	3/4" MHT × 3/4" FIP, 1/Bag	BI	5	60	\$10.29
<b>FHT × FIP</b>					
938-7530101	3/4" FHT × 3/4" FIP, 1/Bag	BI	5	60	\$5.04



938-693030101



938-7530101

Supply

Drainage

Support

Specialties

Appendix

Supply

Drainage

Support

Specialties

Appendix



938-65303000



938-773030201



938-4930101

## Nylon Garden Hose Straight Adapters

### Hose Barb

Item Number	Item Description	Pkg Type	Min Qty	Case Qty	Price
<b>MHT × HOSE BARB</b>					
938-65303001	3/4" MHT × 3/4" Barb, 1/Bag	BI	5	40	\$3.69
938-66302001	3/4" MHT × 1/2" Barb, 1/Bag	BI	5	40	\$4.02
938-66302501	3/4" MHT × 5/8" Barb, 1/Bag	BI	5	40	\$3.69
<b>FHT × HOSE BARB</b>					
938-783010201	3/4" FHT × 1/4" Barb, 1/Bag	BI	5	60	\$4.37
938-783016201	3/4" FHT × 3/8" Barb, 1/Bag	BI	5	60	\$4.37
938-783020201	3/4" FHT × 1/2" Barb, 1/Bag	BI	5	60	\$4.02
938-783025201	3/4" FHT Swivel × 5/8" Barb, 1/Bag	BI	5	60	\$4.37

## Nylon Garden Hose Cap

Item Number	Item Description	Pkg Type	Min Qty	Case Qty	Price
938-4930101	3/4" FHT, 1/Bag	BI	5	60	\$1.82

# Hose Clamps

**Stainless Steel Hose Clamps**

**Easy Clamps**





**Stainless Steel Hose Clamps**

Item Number	Item Description	Pkg Type	Min Qty	Case Qty	Price
<b>5/16" WIDE</b>					
905-050402	Trade Size 4, 1/4" OD To 5/8" OD, 2/Bag	B	5	60	\$2.14
905-050602	Trade Size 6, 5/16" OD To 7/8" OD, 2/Bag	B	5	60	\$2.30
905-050802	Trade Size 8, 7/16" OD To 1" OD, 2/Bag	B	5	60	\$2.98
905-051202	Trade Size 12, 1/2" OD To 1-1/4" OD, 2/Bag	B	5	60	\$3.17
905-052402	Trade Size 24, 1" OD To 2" OD, 2/Bag	B	5	60	\$2.83
905-053602	Trade Size 36, 1-3/4" OD To 2-3/4" OD, 2/Bag	B	5	60	\$2.67
905-055602	Trade Size 56, 3" OD To 4" OD, 1/Bag	B	10	60	\$1.93
905-057202	Trade Size 72, 3" OD To 5" OD, 1/Bag	B	10	60	\$2.28
905-058802	Trade Size 88, 4" OD To 6" OD, 1/Bag	B	10	60	\$4.61
<b>1/2" WIDE</b>					
905-160802	Trade Size 8, 7/16" OD To 1" OD, 2/Bag	B	10	120	\$2.68
901-10	Trade Size 10, 1/2" OD To 1-1/16	B	10	100	\$1.75
901-12	Trade Size 12, 1/2" To 1-1/4", 10/Bag	B	10	100	\$1.94
901-16	Trade Size 16, 11/16" OD To 1-1/2" OD, 10/Bag	B	10	100	\$1.97
901-20	Trade Size 20, 3/4" OD To 1-3/4" OD, 10/Bag	B	10	100	\$1.98
901-24	Trade Size 24, 1" OD To 2" OD, 10/Bag	B	10	100	\$2.17
901-28	Trade Size 28, 1-1/4" OD To 2-1/4" OD, 10/Bag	B	10	100	\$2.23
901-32	Trade Size 32, 1-1/2" OD To 2-1/2" OD, 10/Bag	B	10	100	\$2.27
905-163602	Trade Size 36, 1-3/4" OD To 2-3/4" OD, 2/Bag	B	1	10	\$2.15



905-050402



901-20

**EasyClamps**

Item Number	Item Description	Pkg Type	Min Qty	Case Qty	Price
906-0402	1/4" OD, 2/Bag	BI	5	60	\$2.14
906-0502	5/16" OD, 2/Bag	BI	5	60	\$5.33
906-0602	3/8" OD, 2/Bag	BI	5	60	\$1.58
906-0802	1/2" OD, 2/Bag	BI	5	60	\$1.51
906-1002	5/8" OD, 2/Bag	BI	5	40	\$1.62
906-1202	3/4" OD, 2/Bag	BI	10	120	\$3.36
906-1402	7/8" OD, 2/Bag	BI	10	120	\$2.32



906-0402

Supply

Drainage

Support

Specialties

Appendix



# Valves & Cocks

**Straight, Angle**

**Saddle Valves**

**Cooler Fittings**

**Drain Cocks**

**Shutoff Cocks**

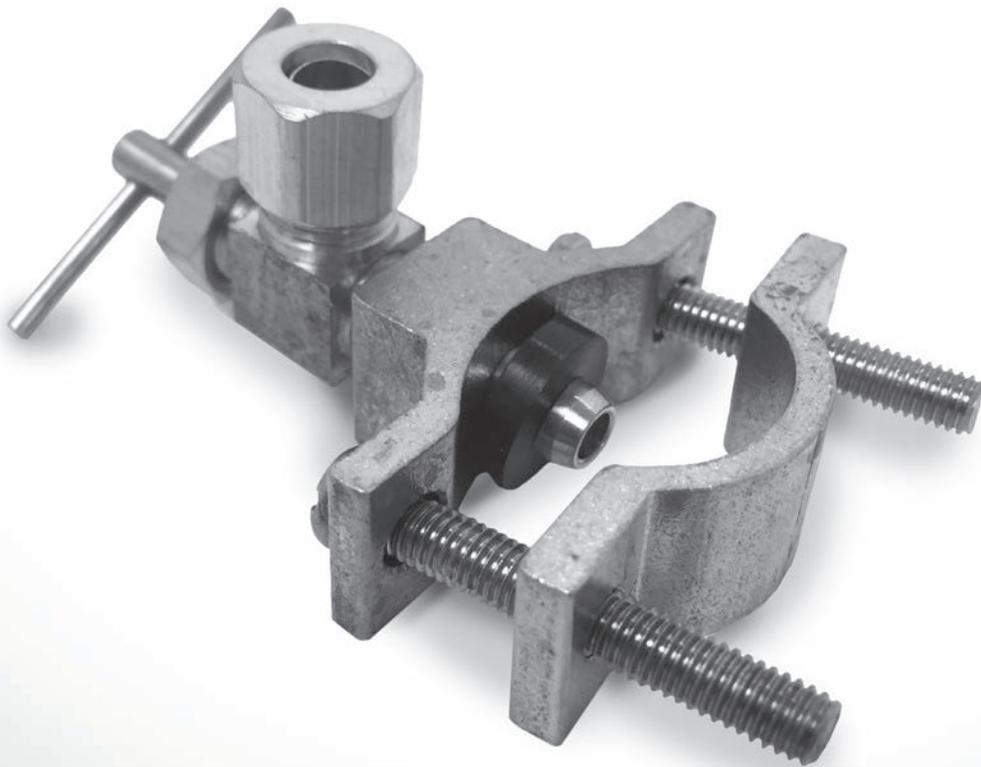



**997-400201**  
Page 745



**997-020201104001**  
Page 745



**997-940201**  
Page 746



**999-56200201**  
Page 746



**999-211610V01**  
Page 746



**998-05024001**  
Page



**998-301001**  
Page 747



Needle Valves - Straight

Item Number	Item Description	Pkg Type	Min Qty	Case Qty	Price
<b>ANDER-LIGN</b>					
997-400201	1/4" OD Ander-Lign, 1/Bag	Bl	5	60	\$13.15
997-401001	3/8" OD Ander-Lign, 1/Bag	Bl	5	60	\$19.88
<b>ANDER-LIGN × MIP</b>					
997-010201104001	1/4" OD Ander-Lign Less Inerts × 1/4" MIP, 1/Bag	Bl	5	60	\$14.82
997-42020201	1/4" OD Ander-Lign × 1/8" MIP, 1/Bag	Bl	5	40	\$10.78
<b>COMPRESSION</b>					
997-010206020601	1/4" OD Comp, 1/Bag	Bl	5	60	\$6.92
<b>COMPRESSION × MIP</b>					
997-010206024001	1/4" OD Comp × 1/8" MIP, 1/Bag	Bl	5	60	\$6.72
<b>FIP</b>					
997-0102440244	1/8" FIP, 1/Bag	Bl	5	60	\$23.25



997-400201



997-010206020601



997-010206024001



997-0102440244

Needle Valves - Angled

Item Number	Item Description	Pkg Type	Min Qty	Case Qty	Price
<b>ANDER-LIGN × MIP</b>					
997-0242020201	1/4" OD Ander-Lign × 1/8" MIP, 1/Bag	Bl	5	60	\$6.22
<b>COMPRESSION × MIP</b>					
997-020201104001	1/4" OD Comp × 1/4" MIP, 1/Bag	Bl	5	60	\$11.45
997-020206024001	1/4" OD Comp × 1/8" MIP, 1/Bag	Bl	5	60	\$8.72



997-0202011040



997-020201104001

Supply

Drainage

Support

Specialties

Appendix

Supply



997-940201

### Needle Valves - Saddle Valves

**Related Products**

Add-A-Line™ Push-Fit Tee p 129

Item Number	Item Description	Pkg Type	Min Qty	Case Qty	Price
<b>SELF-TAPPING</b>					
997-940201	Self-Tapping 1/4" OD Ander-Lign, Rough Brass, 1/Bag	BI	5	60	\$9.25
997-941001	Self-Tapping 3/8" OD Ander-Lign, Rough Brass, 1/Bag	BI	5	40	\$9.25

Drainage

Support



999-56200201

### Cooler Fittings

#### FIP x MIP Adapter

Item Number	Item Description	Pkg Type	Min Qty	Case Qty	Price
999-56200201	1/2" FIP x 1/2" MIP Cooler Adapter w/ 1/8" Tap, 1/Bag	BI	5	60	\$10.78
999-56300201	3/4" FIP x 3/4" MIP Cooler Adapter w/ 1/8" Tap, 1/Bag	BI	5	60	\$47.14

Specialties



999-211610V01

### Cooler Fittings

#### Cooler Valve

Item Number	Item Description	Pkg Type	Min Qty	Case Qty	Price
999-211610V01	3/8" OD x 3/8" OD w/ 1/4" OD Needle Ander-lign, Rough Brass 1/Bag	BI	5	60	\$23.92

Appendix

### Drain Cocks

Item Number	Item Description	Pkg Type	Min Qty	Case Qty	Price
998-05104001	1/4" MIP w/ Tee Handle, 1/Bag	BI	5	60	\$15.46

**Shutoff Cocks**

Item Number	Item Description	Pkg Type	Min Qty	Case Qty	Price
<b>COMPRESSION</b>					
998-301001	3/8" OD Comp, 1/Bag	Bl	5	20	\$17.97
<b>MIP x FIP</b>					
998-011044104001	1/4" FIP x 1/4" MIP, 1/Bag	Bl	5	60	\$29.29
<b>FLARE x FIP</b>					
998-51102001	3/8" OD Flare x 1/2" FIP, 1/Bag	Bl	5	20	\$47.78
998-51162001	1/2" OD Flare x 1/2" FIP, 1/Bag	Bl	5	20	\$35.47
<b>FLARE x FLARE</b>					
998-011048104801	3/8 OD Flare	Bl	5	40	\$21.73



998-301001



998-011044104001



998-51102001

Supply

Drainage

Support

Specialties

Appendix



# Pool Hose Fittings

**Couplings**

**Cuffs**





**Pool Hose Couplings**

Item Number	Item Description	Pkg Type	Min Qty	Case Qty	Price
902-125001	1-1/4", 1/Bag	Bl	2	24	\$7.69
902-126001	1-1/2", 1/Bag	Bl	2	24	\$7.72



902-126001

Supply

Drainage

Support

Specialties

Appendix





# **Tools & Chemicals**

**PowerPEX<sup>®</sup> Tools**

**Tools & Accessories**

**Brushes & Abrasives**

**Sealants, Lubricants  
& Tapes**

**Chemicals**

# Tools & Chemicals

## PowerPEX<sup>®</sup> Tools

Crimp tools for PEX F1807 and F2159 joints using a copper crimp ring, and compression tools for joints using the stainless steel V-Sleeve<sup>™</sup>. Expansion tools and heads for F1960 joints with PEX expansion sleeves.

## Tools & Accessories

A variety of cutting tools, wrenches, and other tools for all types of plumbing installations.

## Brushes & Abrasives

Brushes for applying pipe dope and cement, and abrasive pads/tools for cleaning copper.

## Sealants, Lubricants & Tapes

Adhesive and thread-sealing tapes, hydraulic cement and silicone thread/stem lubricant.

## Chemicals

FlowEasy<sup>™</sup> fast-acting, drain cleaner uses buffered sulphuric acid to dissolve clogs without damage to plumbing systems

# PowerPEX<sup>®</sup> Tools

ASTM F1807/F2159 Tools

ASTM F1960 Tools





## ASTM F1807/F2159 Tools

### Crimp Tools

Item Number	Item Description	Pkg Type	Min Qty	Case Qty	Price
<b>STANDARD</b>					
305-7023	1/2"- 3/4", Straight Handle	Bl	1	10	\$167.94
305-7040	1", Straight Handle	Bl	1	10	\$177.81
305-7050	1-1/4", Straight Handle	Bl	1	10	\$187.14
305-7095	5-N-1 Combo Kit w/ Case (3/8"- 1/2"- 5/8"- 3/4"- 1") Straight Handle	Bl	1	5	\$249.96
<b>COMPACT</b>					
305-7110	3/8" w/ Case	Bl	1	8	\$128.42
305-7120	1/2" w/ Case	Bl	1	8	\$128.42
305-7123	1/2"- 3/4" w/ Case	Bl	1	8	\$163.84
305-7130	3/4" w/ Case	Bl	1	8	\$128.42
305-7141	1" w/ Case	Bl	1	5	\$169.90
<b>GO/NO-GO CRIMP GAUGE</b>					
305-995	3/8", 1/2", 5/8", 3/4", 1", 1/Bag	Bl	1	200	\$8.73



305-7095



305-7120

## ASTM F1807/F2159 Tools

### Crimp Ring Removal Tools

· Use only on Brass or Stainless Steel fittings

Item Number	Item Description	Pkg Type	Min Qty	Case Qty	Price
305-999	3/8" - 1"	Bl	1	40	\$72.70



305-999

## ASTM F1807/F2159 Tools

### V-Sleeve™ Compression Tools

· Exclusively for installing Sioux Chief's V-Sleeve™ stainless steel PEX compression system

Item Number	Item Description	Pkg Type	Min Qty	Case Qty	Price
<b>STANDARD COMPRESSION TOOL</b>					
305-802	1/2" Straight Handle	Bl	1	20	\$192.00
305-804	1" Straight Handle	Bl	1	10	\$212.00
<b>RATCHETING COMPRESSION TOOL</b>					
305-802R	1/2" Ratcheting Straight Handle	B	1	20	\$192.00
305-803R	3/4" Ratcheting Straight Handle	B	1	20	\$192.00
305-804R	1" Ratcheting Straight Handle	B	1	10	\$212.00
<b>COMPACT COMPRESSION TOOL</b>					
305-92TX	1/2"	Bl	1	10	\$154.12
<b>GO/NO-GO COMPRESSION GAUGE</b>					
305-85TX	1/2", 3/4", & 1"	Bl	1	12	\$11.47



305-82TX



305-92TX



305-85TX

Supply

Drainage

Support

Specialties

Appendix

Supply

Drainage

Support

Specialties

Appendix



305-649

### ASTM F1807/F2159 Tools

#### Cinch Tools

Item Number	Item Description	Pkg Type	Min Qty	Case Qty	Price
305-649	3/8" -1"	BI	1	10	\$49.96

### ASTM F1960 Tools

#### Expansion Tools

· To insure a proper joint, Sioux Chief suggests the use of a power rotating tool



305-W2H

Item Number	Item Description	Pkg Type	Min Qty	Case Qty	Price
305-W23KIT	F1960 Standard Tool Kit w/ 1/2" & 3/4" Heads	BI	1	5	\$457.50
305-WT	F1960 Pipe Expander Tool Only	BI	1	10	\$254.32
<b>EXPANDER HEADS</b>					
305-W2H	1/2"	BI	1	20	\$97.84
305-W3H	3/4"	BI	1	20	\$97.84
305-W4H	1"	BI	1	20	\$97.84

### PowerPex® Coil Unwinder



305-X665

Item Number	Item Description	Pkg Type	Min Qty	Case Qty	Price
305-X665	PEX Tube Coil Unwinder	BI	1	1	\$467.53

# **Tools & Accessories**

**Tube Cutters, SawHorse™, Inside Pipe Cutter**

**Metal Stud Punch, Slip-Joint Pliers, Box Wrench**

**Basin Wrench, Allen Wrench Set, Strap Wrench**

**PO Plug Wrench, Faucet Seat Wrench**

**Tub/Shower Socket Set, Element Wrench**

**Screwdrivers, Push-fit Disconnect Tools**

**Faucet Handle Puller, Flaring Tool**

**Inspection Mirror, Levels, Tape Measure**

**Plunger, Work Gloves, Tie-Down Straps**

**Buckets, Boxes**



**304-11**  
Page 761



**315-10**  
Page



**300-12**  
Page 761



**390-50153**  
Page 762



**304-06**  
Page 763



**306-10**  
Page 763



**316-2**  
Page 763



**390-50197**  
Page 763



**307-625**  
Page 764



**311-10**  
Page 765



**314-10**  
Page 765



**305Q2**  
Page 765



**305-RT**  
Page 765



**318-4**  
Page 766



**390-50138**  
Page 766



**390-50117**  
Page



**390-50115**  
Page 766



**310-12**  
Page 767



**310-05**  
Page



**312-2**  
Page 767



**961-32**  
Page 767



**319-15**  
Page 767



**968-04**  
Page



**965-204**  
Page 768



**390-50200**  
Page 768



**Poly Tube Cutters**

Item Number	Item Description	Pkg Type	Min Qty	Case Qty	Price
<b>STANDARD</b>					
304-08	Plastic Tube And Hose Cutter - 2-1/4" Blade Length	Bl	12	72	\$24.37
304-1	Replacement Blade For 304-08	Bl	1	50	\$9.07
304-12	Plastic Tube And Hose Cutter - 3-1/4" Blade Length	Bl	12	12	\$24.37
304-12B	Replacement Blade For 304-12	Bl	12	12	\$10.52
<b>RATCHETING</b>					
304-11	Cuts 3/8" Thru 1-1/4" Diameter Tube/Pipe	Bl	12	12	\$29.65
305-A139092	Cuts 1-1/4" Thru 2" Diameter Tube/Pipe	Bl	1	10	\$309.26
305-A139092B	Replacement Blade for 305-A139092	Bl	1	25	\$35.62



304-08



304-11

**Copper Tube Cutters**

Item Number	Item Description	Pkg Type	Min Qty	Case Qty	Price
304-20	Mini Cutter, 1/8" Thru 5/8" Capacity	Bl	1	24	\$9.96
304-30	Zip Action Cutter w/ Deburring Tool, 3/16" Thru 1-1/4" Capacity	Bl	1	10	\$46.67
304-32	Replacement Wheel For 304-25/304-30	Bl	1	20	\$5.24



304-20

**Utility Knife**

Item Number	Item Description	Pkg Type	Min Qty	Case Qty	Price
315-1	Replacement Blades, 5 Blades/Card	B	10	100	\$2.88



315-10

**SawHorse™ Multi-Purpose Saws**

Item Number	Item Description	Pkg Type	Min Qty	Case Qty	Price
<b>SAWS</b>					
300-12	12" w/ Plastic Teeth Protector	B	12	12	\$21.20
300-20	20" w/ Plastic Teeth Protector	B	4	4	\$44.75
<b>REPLACEMENT BLADES</b>					
300-20B	Replacement Blade For 300-20	B	6	6	\$30.78



300-12



300-20

Supply

Drainage

Support

Specialties

Appendix

Supply



301-062

Drainage



301-065

Support



301-061

Specialties



390-50105

Appendix



390-50153



390-50163



390-50154

### SawHorse™ Mini Hacksaws

Item Number	Item Description	Pkg Type	Min Qty	Case Qty	Price
<b>SAWS</b>					
301-062	Deluxe Pistol Grip, 6" Blade	B	10	10	\$17.20
301-065	Standard D-Type, 6" Blade	B	20	20	\$3.59
<b>REPLACEMENT BLADES</b>					
301-061	6" Carbon Steel Replacement Blade 32 Teeth/Inch, Pin Ends	B	5	100	\$1.28

### Wire Cable Saw

Item Number	Item Description	Pkg Type	Min Qty	Case Qty	Price
390-50105	36" Wire Cable Saw For Plastic Pipe	BI	25	25	\$4.00

### Inside Pipe Cutter

Item Number	Item Description	Pkg Type	Min Qty	Case Qty	Price
<b>PIPE CUTTER</b>					
390-50153	Inside Pipe Cutter w/ Two 1-9/16" Abrasive Discs	BI	10	100	\$16.53
390-50163	Inside Pipe Cutter w/ 1-1/4" Steel Blade	BI	10	100	\$19.10
<b>REPLACEMENT BLADES</b>					
390-50154	Kit: 3 Abrasive Discs, 1 Bolt, 1 Washer	BI	10	100	\$13.42
390-50164	1 Hardened Steel Blade Only	BI	10	100	\$4.35

**Deburring Tool**

Item Number	Item Description	Pkg Type	Min Qty	Case Qty	Price
304-06	Deburring Tool, Includes One Spare Blade	BI	24	24	\$11.15



304-06

**Metal Stud Punch**

Item Number	Item Description	Pkg Type	Min Qty	Case Qty	Price
305-521PK	1-11/32" Hole w/ Carrying Case	BI	1	5	\$304.95
305-521PKB	Cutting Bit Replacement	B	1	10	\$25.54



305-521PK

**Slip-Joint Pliers**

Item Number	Item Description	Pkg Type	Min Qty	Case Qty	Price
306-10	10" Angle-Nose Pliers	BI	10	50	\$28.30



306-10

**Ratcheting Offset Box Wrenches**

Item Number	Item Description	Pkg Type	Min Qty	Case Qty	Price
316-1	3/8" x 7/16" Ratchet Box Wrench	BI	12	12	\$8.84
316-2	1/2" x 9/16" Ratchet Box Wrench	BI	12	12	\$10.89



316-2

**Telescoping Basin Wrench**

Item Number	Item Description	Pkg Type	Min Qty	Case Qty	Price
390-50197	Telescopic Basin Wrench	BI	1	20	\$29.83



390-50197

**Allen Wrench Set**

Item Number	Item Description	Pkg Type	Min Qty	Case Qty	Price
318-9	9Pc Fold-Up Allen Wrench Set	BI	10	10	\$8.46



318-9

Supply

Drainage

Support

Specialties

Appendix

Supply



313-20

### Strap Wrench

Item Number	Item Description	Pkg Type	Min Qty	Case Qty	Price
313-20	Strap Wrench	BI	12	12	\$22.34

Drainage



307-625

### Shower Arm Installation Tool

Item Number	Item Description	Pkg Type	Min Qty	Case Qty	Price
307-625	Shower Arm Installation Tool	BI	6	6	\$11.06

Support



390-50198

### PO Plug Wrench

Item Number	Item Description	Pkg Type	Min Qty	Case Qty	Price
390-50198	Pop-Up & Overflow Plug Wrench	BI	20	20	\$10.82

Specialties



390-50130

### Faucet Seat Wrenches

Item Number	Item Description	Pkg Type	Min Qty	Case Qty	Price
390-50130	Ratchet Wrench Set	BI	1	25	\$43.88
390-50132	Straight Wrench Tool	BI	12	12	\$10.85
390-50133	Angle Wrench Tool	BI	12	12	\$11.93

Appendix



390-50134

### Faucet Stem Key

Item Number	Item Description	Pkg Type	Min Qty	Case Qty	Price
390-50134	Four-Way Faucet Stem Key	BI	12	12	\$6.91

**Tub/Shower Socket Set**

Item Number	Item Description	Pkg Type	Min Qty	Case Qty	Price
311-10	Set w/ Carrier Handle	Bl	5	5	\$22.91



311-10

**Water Heater Element Wrench**

Item Number	Item Description	Pkg Type	Min Qty	Case Qty	Price
390-50185	Water Heater Element Wrench	Bl	10	10	\$13.70



390-50185

**Screwdrivers**

Item Number	Item Description	Pkg Type	Min Qty	Case Qty	Price
314-10	Six-In-One Screwdriver, Red Handle - Display Pack	Bl	12	12	\$11.59
314-12	Six-In-One w/ Easy Grip Rubber Handle	Bl	12	12	\$12.27



314-10



314-12

**PDQ™ Push-Fit Disconnect Tools**

Item Number	Item Description	Pkg Type	Min Qty	Case Qty	Price
305Q2	1/2", 1/Bag	Cl	24	24	\$2.41
305Q23PK1	1/2" & 3/4", 1 Pair/Bag	Bl	12	12	\$4.80
305Q3	3/4", 1/Bag	Cl	24	24	\$2.41
305Q4	1", 1/Bag	Cl	12	12	\$2.70
305Q4PK1	1", 1/Bag	Bl	5	400	\$2.95
305Q5	1-1/4", 1/Bag	Bl	5	5	\$26.60
305Q6	1-1/2", 1/Bag	Bl	1	1	\$28.33
305Q7	2", 1/Bag	Bl	1	1	\$28.33



305Q3

**Access Grommet Removal Tool**

Item Number	Item Description	Pkg Type	Min Qty	Case Qty	Price
305-RT	Valve Grommet Removal Tool For Access Products	Bl	1	10	\$6.54



305-RT

Supply

Drainage

Support

Specialties

Appendix

Supply



307-616

### Shower WallNut™ Removal Tool

Item Number	Item Description	Pkg Type	Min Qty	Case Qty	Price
307-616	Shower Wallnut Removal Tool	BI	1	10	\$39.08

Drainage



390-50128

### Moen Cartridge Puller

Item Number	Item Description	Pkg Type	Min Qty	Case Qty	Price
390-50128	Puller For Moen	BI	12	12	\$14.56

Support



318-4

### Faucet Handle Puller

Item Number	Item Description	Pkg Type	Min Qty	Case Qty	Price
318-4	Faucet Handle Puller	BI	5	5	\$19.37

Specialties



308-2

### Flaring Tool

Item Number	Item Description	Pkg Type	Min Qty	Case Qty	Price
308-2	Deluxe Flaring Tool	BI	1	12	\$69.43

Appendix



390-50138

### O-Ring Pick

Item Number	Item Description	Pkg Type	Min Qty	Case Qty	Price
390-50138	Deluxe O-Ring Pick	BI	12	12	\$7.93



390-50115

### Inspection Mirror

Item Number	Item Description	Pkg Type	Min Qty	Case Qty	Price
390-50115	Extendable Inspection Mirror w/ Magnetic Tip	BI	24	24	\$13.17

**Match Holder**

Item Number	Item Description	Pkg Type	Min Qty	Case Qty	Price
390-50110	Extendable Match Holder w/ Pocket Clasp	BI	25	25	\$11.90



390-50110

**Levels**

Item Number	Item Description	Pkg Type	Min Qty	Case Qty	Price
310-12	10" Aluminum Level, Magnetic	BI	10	10	\$23.07



310-10

**Plunger**

Item Number	Item Description	Pkg Type	Min Qty	Case Qty	Price
312-2	Funnel Type Rubber Plunger - 20" Handle	BI	12	12	\$9.95



312-2

**SafeFlame™ Protection Pad**

Item Number	Item Description	Pkg Type	Min Qty	Case Qty	Price
390-50160	Flame Protection Blanket	BI	1	25	\$23.59



390-50160

**Work Gloves**

Item Number	Item Description	Pkg Type	Min Qty	Case Qty	Price
961-20	Brown Jersey Gloves, 1/Pair	B	24	24	\$3.26
961-22	Knit Gloves w/ Gripping Dots, 1/Pair	B	24	24	\$3.88
961-32	All Leather Gloves, Large, 1/Pair	B	1	12	\$14.05
961-34	All Leather Gloves, Extra Large, 1/Pair	B	1	12	\$14.05



961-32

**Tie-Down Straps**

Item Number	Item Description	Pkg Type	Min Qty	Case Qty	Price
319-15	15"- 22" EPDM Tie-Down Strap	B	50	50	\$2.98
319-20	20"- 30" EPDM Tie-Down Strap	B	50	50	\$3.21
319-31	31"- 45" EPDM Tie-Down Strap	B	50	50	\$4.19



319-20

Supply

Drainage

Support

Specialties

Appendix

Supply

Drainage

Support

Specialties

Appendix



965-204



390-50200

### Bin Boxes

Item Number	Item Description	Pkg Type	Min Qty	Case Qty	Price
965-204	12" Deep x 4" Wide x 4-1/2" High	B	25	25	\$2.80
965-208	12" Deep x 8" Wide x 4-1/2" High	B	25	25	\$4.06
965-212	12" Deep x 12" Wide x 4-1/2" High	B	25	25	\$4.69
965-804	18" Deep x 4" Wide x 4-1/2" High	B	25	25	\$3.90
965-808	18" Deep x 8" Wide x 4-1/2" High	B	25	25	\$4.69
965-812	18" Deep x 12" Wide x 4-1/2" High	B	25	25	\$5.18

### Peg-Board Hook

Item Number	Item Description	Pkg Type	Min Qty	Case Qty	Price
390-50200	Peg Board Hook	B	10	50	\$1.30



# **Brushes & Abrasives**

**Fitting Brushes**

**Acid/Cement Brushes**

**Tube OD Brush**

**Abrasive Cleaning Pads**

**Abrasive Mesh**





**Fitting Brushes**

Item Number	Item Description	Pkg Type	Min Qty	Case Qty	Price
<b>DELUXE WOOD HANDLE</b>					
704-2	1/2" CTS, Stainless Steel	B	12	72	\$2.90
704-3	3/4" CTS, Stainless Steel	B	12	72	\$3.32
704-4	1" CTS, Stainless Steel	B	12	72	\$3.35
<b>PLASTIC HANDLE</b>					
700-0	1/4" CTS, Carbon Steel	B	12	120	\$5.24
700-1	3/8" CTS, Carbon Steel	B	12	120	\$4.03
700-2	1/2" CTS, Carbon Steel	B	12	120	\$4.03
700-3	3/4" CTS, Carbon Steel	B	12	120	\$4.18
700-4	1" CTS, Carbon Steel	B	12	120	\$4.57
700-5	1-1/4" CTS, Carbon Steel	B	6	60	\$4.97
700-6	1-1/2" CTS, Carbon Steel	B	6	60	\$5.42
700-7	2" CTS, Carbon Steel	B	6	60	\$6.31
705-2	1/2" CTS, Stainless Steel	B	12	120	\$9.82
705-3	3/4" CTS, Stainless Steel	B	12	120	\$10.22
705-4	1" CTS, Stainless Steel	B	12	120	\$9.32
<b>OPEN-LOOP HANDLE</b>					
702-2	1/2" CTS, Carbon Steel	B	24	240	\$1.79
702-3	3/4" CTS, Carbon Steel	B	24	240	\$1.86
702-4	1" CTS, Carbon Steel	B	24	240	\$2.12
703-2	1/2" CTS, Stainless Steel	B	24	240	\$1.91
703-3	3/4" CTS, Stainless Steel	B	24	240	\$1.96
703-4	1" CTS, Stainless Steel	B	24	240	\$2.21
703-5	1-1/4" CTS, Stainless Steel	B	12	120	\$3.42
703-6	1-1/2" CTS, Stainless Steel	B	6	60	\$3.73
703-7	2" CTS, Stainless Steel	B	6	60	\$4.20
<b>DRILL ATTACHMENT</b>					
706-2	1/2" CTS, Carbon Steel	B	12	72	\$2.04
706-3	3/4" CTS, Carbon Steel	B	12	72	\$2.11
706-4	1" CTS, Carbon Steel	B	12	72	\$2.41
707-2	1/2" CTS, Stainless Steel	B	12	72	\$2.22
707-3	3/4" CTS, Stainless Steel	B	12	72	\$2.30
707-4	1" CTS, Stainless Steel	B	12	72	\$2.54

**Acid/Cement Brushes**

Item Number	Item Description	Pkg Type	Min Qty	Case Qty	Price
<b>ACID BRUSHES</b>					
771	3/8" Wide, 6" Long, 100% Horse Hair, 144/Bag	B	1	12	\$35.73
772	1/2" Wide, 6" Long, 100% Horse Hair, 144/Bag	B	1	12	\$45.15
<b>DOPE/CEMENT BRUSHES</b>					
773	3/4" Wide, Horse Hair	B	36	360	\$2.18
774	1" Wide, Natural	B	36	36	\$3.41
776	1 1/2" Wide, Natural	B	24	24	\$4.99



704-2



700-2



703-2



706-3



771



774

Supply

Drainage

Support

Specialties

Appendix

Supply



710-2

**Tube OD Brush**

Item Number	Item Description	Pkg Type	Min Qty	Case Qty	Price
710-2	1/2" CTS	B	6	120	\$7.56
710-3	3/4" CTS	B	6	120	\$8.50
710-4	1" CTS	B	6	120	\$9.61

Drainage



750-46

**Abrasive Cleaning Pads**

Item Number	Item Description	Pkg Type	Min Qty	Case Qty	Price
750-46	4" x 6" Fine Grit, Red Nylon Pad, 10 /Bag	B	14	14	\$11.75
750-69	6" x 9" Fine Grit, Tight Weave, Red Nylon Pad, 5/Bag	B	12	12	\$10.01
752-69	6" x 9" Medium Grit, Loose Weave, Green Nylon Pad, 5/Bag	B	12	12	\$7.57

Support

Specialties



730-05

**Abrasive Mesh/Cloth**

Item Number	Item Description	Pkg Type	Min Qty	Case Qty	Price
<b>ABRASIVE MESH</b>					
730-05	5 Yard Roll In Dispenser Box	BI	24	24	\$10.25
730-10	10 Yard Roll In Dispenser Box	BI	24	24	\$17.14
730-25	25 Yard Roll In Dispenser Box	BI	12	12	\$38.21
<b>SAND CLOTH</b>					
740-02	2 Yard Roll In Bag	BI	50	50	\$1.42
740-05	5 Yard Roll In Dispenser Box	BI	24	24	\$4.81
740-10	10 Yard Roll In Dispenser Box	BI	24	24	\$9.77
740-25	25 Yard Roll In Dispenser Box	BI	12	12	\$24.44
<b>WET-PROOF CLOTH</b>					
743-05	5 Yard Roll In Dispenser Box	BI	24	24	\$6.71
743-10	10 Yard Roll In Dispenser Box	BI	24	24	\$11.89
743-25	25 Yard Roll In Dispenser Box	BI	12	12	\$24.19

Appendix



740-10



743-05

# Sealants, Lubricants & Tapes

**Sealants**

**Lubricants**

**Tapes**





**Sealants**

**Cement Stop Leak**

Item Number	Item Description	Pkg Type	Min Qty	Case Qty	Price
963-05	Cement Stop Leak, 5 Lb. Plastic Jar	BI	5	5	\$28.73



963-05

**Sealants**

**Oakum**

Item Number	Item Description	Pkg Type	Min Qty	Case Qty	Price
963-15PK2	Brown Oakum, 1 Lb/Bag	BI	20	20	\$19.08



963-15PK2

**Lubricants**

**Silicone Lubricant**

Item Number	Item Description	Pkg Type	Min Qty	Case Qty	Price
963-01	Silicone Lubricant - 1/4 Oz. Tub	B	24	240	\$4.26



963-01

**Tapes**

**Duct Tape**

· HVAC grade has more adhesive

Item Number	Item Description	Pkg Type	Min Qty	Case Qty	Price
330-260	2" Wide x 60 Yard Roll, Industrial Grade 9 Mil	BI	24	24	\$14.99
332-260	2" Wide x 60 Yard Roll, HVAC Grade 11.5 Mil	BI	24	24	\$24.64



330-260

**Tapes**

**Pipe Thread Tape**

Item Number	Item Description	Pkg Type	Min Qty	Case Qty	Price
335-260	1/2" x 260" Spool	BI	100	500	\$0.62
335-263	3/4" x 260" Spool	BI	70	350	\$0.94
335-520	1/2" x 520" Spool	BI	100	500	\$0.95
335-523	3/4" x 520" Spool	BI	70	350	\$1.56



335-260

Supply

Drainage

Support

Specialties

Appendix





# Chemicals

## FlowEasy™ Drain Cleaner





## FlowEasy™ - Liquid Drain Cleaner

Item Number	Item Description	Pkg Type	Min Qty	Case Qty	Price
963-HTL-FE128	One-Gallon Bottle FlowEasy™	BI	4	4	\$65.00
963-HTL-FE20	20 oz Bottle FlowEasy™	BI	12	12	\$16.07
963-HTL-FE32	32 Oz Bottle FlowEasy™	BI	12	12	\$23.31
963-HTL-FE64	Half-Gallon Bottle FlowEasy™	BI	4	4	\$41.28



963-HTL-FE128

Supply

Drainage

Support

Specialties

Appendix



# **Appendix**

**Alphabetical Index**

**Numerical Index**

**Rep Information**

**General Reference**

**Warranty & Terms**



1

- 1/2" F1807 Branch, Manifold 32-37
  - 1" CPVC x Spun Closed Trunk 37
  - 1" F1807 x 1" F1807 Trunk 34
  - 1" F1807 x Spun Closed Trunk 33
  - 1" FSWT x Spun Closed Trunk 36
  - 1" MSWT x 1" FSWT Trunk 36
  - 1" MSWT x 1" MSWT Trunk 35
  - 1" MSWT x Spun Closed Trunk 35
  - 1/2" F1807 x 3/4" F1807 Trunk 33
  - 1/2" F1807 x Closed Trunk 33
  - 3/4" F1807 x 1" F1807 Trunk 33
  - 3/4" F1807 x 3/4" F1807 Trunk 32
  - 3/4" F1807 x Spun Closed Trunk 32
  - 3/4" MSWT x 3/4" FSWT Trunk 34
  - 3/4" MSWT x 3/4" MSWT, Extended Trunk 35
  - 3/4" MSWT x Spun Closed Trunk 34
- 1/2" F1807 Branch, Multi-Port Tee 37
  - 3/4" F1807 x 3/4" F1807 Trunk 37
  - 3/4" F1807 x Closed Trunk 37
- 1/2" F1960 Branch, Multi-Port Tee 62
  - 3/4" F1960 PEX x 3/4" F1960 PEX Trunk 62
  - 3/4" F1960 PEX x Closed Trunk 62
- 1/2" F1960 Branch, Manifold 60-61
  - 1" CPVC x Spun Closed Trunk 61
  - 1" MSWT x 1" MSWT Trunk 61
  - 1" MSWT x Spun Closed Trunk 61
  - 3/4" F1960 x Spun Closed Trunk 60
  - 3/4" F1960 x 3/4" F1960 Trunk 60
  - 3/4" MSWT x Spun Closed Trunk 60
- 1/2" F1960 Branch, Poly Manifold 66
  - 1" F1960 x 1" F1960 Trunk 66
  - 1" F1960 x Closed Trunk 66
  - 3/4" F1960 x 3/4" F1960 Trunk 66
  - 3/4" F1960 x Closed Trunk 66
- 1/2" F1960 Branch, Poly Multi-Port Tee 66
- 1/2" Male Sweat Branch, Manifold 116
  - 1" MSWT x 1" FSWT Trunk 116
  - 1" MSWT x 1" MSWT Trunk 116
- 1/2" MIP Branch, Manifold 117
  - 1" MSWT x 1" FSWT Trunk 117
  - 1" MSWT x 1" MSWT Trunk 117
- 1/2" MIP/FSWT Ball Valve Branch, Manifold 118

- 1" MSWT x 1" FSWT Trunk 118
- 1" MSWT x 1" MSWT Trunk 118

- 1/2" Push Fit Branch, Manifold 131
  - 3/4" Push Fit x Spun Closed Trunk 131
  - 3/4" Push Fit x 3/4" Push Fit Trunk 131
- 10" Roof Drain 286
- 10" Roof Drain 364
- 10" Roof Drain & Overflow 289
- 10" Weir Roof Drain 286
- 11" Roof Drain 285
- 11" Roof Drain 363
- 12" Diameter 264-265

- Cast Iron - No-Hub Connection 264
- Cast Iron - Push-Joint Connection 265

- 12" x 12" x 10" 275
- 12" x 12" x 6" 273
- 12" x 12" x 8" 274
- 12" x 12" x 8" 279
- 12" x 8" 277
- 15" Adjustable Weir Roof Drain 284-285
- 15" Roof Drain - Alpha Series 283
- 15" Roof Drain - Bravo Series 283-284
- 15" Roof Drain & Overflow - Alpha Series 288
- 15" Roof Drain & Overflow - Bravo Series 288-289

2

- 20" Large-Capacity Roof Drain 287
- 2-Hole Tube Strap 495

3

- 3/4" Female Sweat Branch, Manifold 117
- 3/4" Male Sweat Branch, Manifold 116-117
  - 1-1/2" MSWT x 1-1/2" FSWT Trunk 116
  - 1-1/4" MSWT x 1-1/4" MSWT Trunk 116
- 2" MSWT x 2" MSWT Trunk 117

8

- 8" Roof Drain 286
- 8" Roof Drain & Overflow 290
- 8" Roof Drain & Overflow - Cast Iron Dome 365
- 8" x 6" 278
- 8" x 8" x 6" 276
- 825 Series - Offset Receptor-Base Style 426
- 825 Series - Receptor-Base Style 426
- 826 Series - Outer-Locknut Style 427
- 840 Series Floor Drains 435

9

- 9" Diameter 263-264
  - Cast Iron - No-Hub Connection 263
  - Cast Iron - Push-Joint Connection 263-264
- 90 - F1807 Elbows 18
- 90 - F1960 Elbows 49
- 90 - F1960 Poly Elbows 63
- 90 - F2159 Elbows 43
- 90 Elbow - PDQ™ Push Fit 123

A

- Above-Grade Floor Drains 255-260
  - Cast Iron - No-Hub Connection 255-257
  - Cast Iron - Push-Joint Connection 257-260
- Above-Grade Floor Drains 343-346
  - ABS on Iron - No-Hub Connection 345
  - ABS on Iron - Push-Joint Connection 346
  - PVC/ABS - Sch. 40 Hub Connection 343-344
- Abrasive Cleaning Pads 772
- Abrasive Mesh/Cloth 772
- ABS - MIP Thread Connection 370-371
- ABS on Iron - No-Hub Connection 338-339
  - 5-1/2" Tops 339
  - 6-1/2" Tops 338
- ABS on Iron - No-Hub Connection 345
- ABS on Iron - Push-Joint Connection 340-342
  - 5-1/2" Tops 341-342
  - 6-1/2" Tops 340-341
- ABS on Iron - Push-Joint Connection 346
- ABS Sch. 40 Hub Connection 458
- Access Cover Cleanouts 306-307
  - Cast Iron - No-Hub Connection 306
  - Cast Iron - Push-Joint Connection 306
  - Heavy-Duty Cleanout Housing 307
- Access Cover Cleanouts 374
- Access Grommet Removal Tool 765
- Access Tools 217
- Accessories 458
- Accessories 461
  - Condensate Trap 461
  - Pipe Bore Adapter 461
  - PVC Vent Cap 461
  - SmartSaddle™ 461
- Acid/Cement Brushes 771

# Alphabetical Index

Supply

Drainage

Support

Specialties

Appendix

Acoustical Isolation Accessories 541  
 Acoustical TD+™ Universal Clamps 541  
 Adapter - Elbow - CPVC 81  
 Adapter - Elbow - F1807 22-23  
   3/4" FIP Swivel 22  
   Female Sweat 23  
   Male Sweat 23  
   MIP 22  
   Tub/Shower Elbow 22  
 Adapter - Elbow - F1960 52-53  
   Female Sweat 53  
   Male Sweat 52  
   MIP 52  
   Tub/Shower Elbow 52  
 Adapter - Elbow - F1960 Poly 65  
 Adapter - Elbow - F2159 45  
   FIP Swivel Elbow 45  
   MIP Elbow 45  
 Adapter - Elbow - PDQ™ Push Fit 126  
   FIP 126  
   MIP 126  
 Adapter - Elbow - Sweat 102  
 Adapter - Elbow - Sweat Leaded 101  
 Adapter - Straight - CPVC 79-81  
   F1807 79  
   F1960 79  
   F3347 79  
   FIP 80  
   FIP Short-N-Swivel™ 81  
   Male Sweat 80  
   MIP 80  
   Press-Fitting 81  
 Adapter - Straight - F1807 19-21  
   CPVC - IPS Gray 20  
   CPVC, CTS 19  
   Female Sweat 21  
   FIP 21  
   Male Sweat 20  
   MIP 21  
   PVC 20  
 Adapter - Straight - F1807 24  
   Compression 24  
   Polybutylene (PB) (ASTM F1380) × PEX 24

Adapter - Straight - F1960 50-52  
   CPVC - IPS Gray 50  
   CPVC, CTS 50  
   Female Sweat 51  
   FIP 52  
   Male Sweat 51  
   MIP 51  
   PVC 50  
 Adapter - Straight - F1960 Poly 65  
 Adapter - Straight - F2159 45  
   FIP Swivel 45  
   MIP 45  
 Adapter - Straight - F3347 71  
 Adapter - Straight - PDQ™ Push Fit 125-126  
   FIP 126  
   FIP Swivel Adapter 125  
   MIP 125  
 Adapter - Straight - PVC 95-96  
   F1807 95  
   F1960 95  
   FIP 96  
   Male Sweat 95  
   MIP 96  
   Press-Fitting and Push Fit Compatible 96  
 Adapter - Straight - Sch 40 CPVC 91-92  
   F1807 91  
   F1960 91  
   FIP 92  
   Male Sweat 91  
   MIP 91  
 Adapter - Sweat/MIP 101  
 Adapter - Trap Primer 150  
 Adapters 110  
 Add-A-Line™ 111  
 Add-A-Line™ 129  
 Add-A-Shower 641  
   Add-A-Rod 641  
   Add-A-Shower 641  
 Add-A-Valve Fitting 613  
 Adjustable Access Cover 375  
 Adjustable Cleanouts 301-305  
   Cast Iron - No-Hub Connection 301-303  
   Cast Iron - Push-Joint Connection 303-305

Adjustable Cleanouts 370-371  
   ABS - MIP Thread Connection 370-371  
   PVC/ABS - Sch. 40 Hub Connection 370  
 Adjustable Concealed Arm 319  
 Adjustable Floor Drain 330-331  
 Adjustable Floor Drain Head 266-267  
   Cast Iron - MIP Thread Connection 267  
   Nickel-Bronze - MIP Thread Connection 266  
   Nickel-Bronze Extended Rim - MIP Thread Connection 266  
   Stainless Steel - MIP Thread Connection 267  
 Adjustable Floor Drain Head 331-332  
 Adjustable Slab Shower Drain 421  
 Adjustable Swivel/Loop 545  
 Adjustable/Multi-Purpose Brackets 533-534  
   SimpleStrap™ 533  
   Slider™ 533  
   Support Bracket 534  
   WiderSlider™ 533  
 Air-Admittance Valve Box 211  
 Allen Wrench Set 763  
 Anchors & Fasteners 499-500  
   Anchors, Screws and Fasteners 499  
   Cable Ties 500  
   Sioux Chief Sammys - Thread Rod Anchors 499  
   Stainless Steel Bands 500  
   StainlessStar™ 500  
 Anchors, Screws and Fasteners 499  
 ApeTape™ 509  
 Arrester - HydraRester™ 143-144  
   CPVC 143  
   MIP 143  
   PEX 144  
   Sweat/Press-Fit 143  
 Arrester - MegaRester™ 144  
   Copper 144  
   Stainless Steel 144  
 Arrester - MiniRester™ 141-142  
   Compression Tee 142  
   Female Compression Tee 142  
   Laundry Hose Tee/Toilet Fill Valve Tee 141  
   PEX Tee 142  
   Straight 141  
   Tub Shower / Stub Out Tee 141



ASTM F1807 - Fittings, Adapters & Connectors 17-24

- Cinch Clamp 17
- Crimp Ring 17
- F1807 Ballcock Adapter 23
- F1807 Coupling 19
- F1807 Elbow 18
- F1807 Elbow Adapter 22-23
- F1807 Faucet Adapter 23
- F1807 Plug 19
- F1807 Straight Adapter 19-21
- F1807 Tee 18
- Straight Adapter 24
- V-Sleeve™ 17

ASTM F1807 Accessories 39

ASTM F1807 Manifolds 32-37

- 1/2" F1807 Branch, Manifold 32-37
- 1/2" F1807 Branch, Multi-Port Tee 37

ASTM F1807 PEX Kits 30-31

- F1807 Stub Out Kit 30-31
- F1807 Water Heater Connector Kit 31

ASTM F1807 Preformed Copper & Valves 25-29

- F1807 Brass Ball Valve 28
- F1807 Bullet™ 26
- F1807 Frost-Proof Anti-Siphon Sillcock 28
- F1807 Ice Maker Valve 29
- F1807 Sillcock 28
- F1807 Stub Out Elbow 25
- F1807 Tub/Shower Pressure Connector 26
- F1807 Water Heater Connector 26-27
- F1807 Water Loop 27

ASTM F1807 Tools 38-40

- Crimp Ring Removal Tool 40
- Crimp Tool 38
- Plastic Tube Cutter 40
- Ratchet Tube Cutter 40
- V-Sleeve™ Compression Tool 40

ASTM F1807/F2159 Tools 757-758

- Cinch Tools 758
- Crimp Ring Removal Tools 757
- Crimp Tools 757
- V-Sleeve™ Compression Tools 757

ASTM F1960 - Metal Fittings, Adapters & Connectors 49-53

- F1960 Coupling 50

- F1960 Elbow 49
- F1960 Elbow Adapter 52-53
- F1960 Expansion Ring 49
- F1960 Straight Adapter 50-52
- F1960 Tee 49
- Wal-Let™ - F1960 53

ASTM F1960 - Poly Fittings, Adapters & Connectors 63-65

- F1960 Expansion Ring 63
- F1960 Poly Coupling 64
- F1960 Poly Elbow 63
- F1960 Poly Elbow Adapter 65
- F1960 Poly Faucet Adapter 65
- F1960 Poly Plug 64
- F1960 Poly Straight Adapter 65
- F1960 Poly Tee 63-64

ASTM F1960 Poly Manifolds 66

- 1/2" F1960 Branch, Poly Manifold 66
- 1/2" F1960 Branch, Poly Multi-Port Tee 66

ASTM F1960 Tools 67

ASTM F1960 Tools 758

ASTM F2159 - Fittings, Adapters & Connectors 43-45

- Cinch Clamp 43
- Crimp Ring 43
- F2159 Poly Coupling 44
- F2159 Poly Elbow 43
- F2159 Poly Elbow Adapter 45
- F2159 Poly Plug 44
- F2159 Poly Straight Adapter 45
- F2159 Poly Tee 44
- V-Sleeve™ 43

ASTM F3347 PEX Kits 73

ASTM F3347 Preformed Copper & Valves 71-72

- F3347 Brass Ball Valve 72
- F3347 Bullet™ 71
- F3347 Straight Adapter 71
- F3347 Stub Out Elbow 71
- F3347 Tub/Shower Pressure Connector 71
- F3347 Water Heater Connector 72

**B**

- Backup Float Valve 454
- Backwater Valve 453-454
- Ball Valve - CPVC - Brass 85
- Ball Valve - F1807 - Brass 28

- Ball Valve - F1960 - Brass 56
- Ball Valve - F3347 - Brass 72
- Ball Valve - PDQ™ Push Fit - Brass 129
- Ball Valve - PVC - Brass 97
- Ball Valve - Sweat - Brass 112
- Ballcock Adapter - F1807 23
- Barrel Valve Kits 707

Bar-Stock & Forged Fittings 694-697

- Bar-Stock Ball Valves 697
- Bar-Stock Caps 695
- Bar-Stock Couplings 694
- Bar-Stock Elbows 695
- Bar-Stock Face Bushings 696
- Bar-Stock Hex Bushings 696
- Bar-Stock Hex Nipples 696
- Bar-Stock Locknuts 697
- Bar-Stock Plugs 697

Bar-Stock Reduced Couplings 694

- Bar-Stock Straight Adapters 695
- Bar-Stock Street Elbows 695
- Bar-Stock Tees 694

Bar-Stock Union Adapters 694

- Reducing Hex Nipples 696

Bar-Stock Ball Valves 697

Bar-Stock Caps 695

Bar-Stock Couplings 694

Bar-Stock Elbows 695

Bar-Stock Face Bushings 696

Bar-Stock Hex Bushings 696

Bar-Stock Hex Nipples 696

Bar-Stock Locknuts 697

Bar-Stock Plugs 697

Bar-Stock Reduced Couplings 694

Bar-Stock Straight Adapters 695

Bar-Stock Street Elbows 695

Bar-Stock Tees 694

Bar-Stock Union Adapters 694

Basket Strainers 593-595

Ball-Lok™ 593

BigBoy™ 593

Champion® 593

Designer Series Double Cup 595

Duo Sink 594

- EezOn™ 594
- Junior™ Bar Sink 595
- KwikFit™ 593
- Lok-Spin® 594
- ProBrite™ 594
- Replacement Baskets 595
- SIG Strainer™ 595
- Specification™ 593
- SweetHeart™ 594
- Basket Strainers & Sink Drains 593-597
  - Basket Strainers 593-595
  - Lav Sink Drains 596-597
- Bath Waste Accessories 604
- Bath Waste Drains 601-604
  - Bath Waste Accessories 604
  - Brass Waste & Overflows 601-602
  - Plastic Waste & Overflows 602-603
- Beam Clamp & Connector Products 545
- Bell-Trap Floor Drains 435
  - Cast Iron No-Hub Connection 435
  - PVC/ABS Sch. 40 Hub Connection 435
- Bend Supports 525
  - PexChair™ 525
  - SideWinder™ 525
  - Simple Bend Support 525
  - Through-Floor Protective Sleeve 525
- BiFolator™ 490
- Bin Boxes 768
- Black Vinyl Tubing 649
- Boiler Drain 113
- Box Clips, Brackets & Supports 216
- Boxes 215
- Branch Tailpieces 583-585
  - Dishwasher 583-584
  - Lavatory 584
  - LongBranch™ Dishwasher Tailpieces 583
  - MajorTee™ 585
- Brass - Slotted 311
- Brass - Square-Head 311
- Brass Boiler Drain 113
- Brass Closet Flange Rings 447
- Brass Compression Couplings 671
- Brass Compression Elbow Adapters 676-677
  - Ander-Lign Less Insert × FIP 677
  - Ander-Lign With Brass Insert × MIP 676-677
  - Compression × FIP 677
  - Compression × MIP 676
- Brass Compression Elbows 672
- Brass Compression Fittings 671-679
  - Brass Compression Couplings 671
  - Brass Compression Elbow Adapters 676-677
  - Brass Compression Elbows 672
  - Brass Compression Reducing Couplings 671
  - Brass Compression Straight Adapters 672-676
  - Brass Compression Tees 671-672
  - Brass Compression to Flare Adapters 676
  - Caps 678
  - Ferrules 677-678
  - Nuts & Inserts 678-679
  - Pilot Line Breakaway Compression Nut 679
- Brass Compression Reducing Couplings 671
- Brass Compression Straight Adapters 672-676
  - Ander-Lign Less Insert × MIP 674
  - Ander-Lign With Brass Insert × FIP 675
  - Ander-Lign With Brass Insert × MIP 673-674
  - Compression × FIP 675
  - Compression × MIP 673
  - Female Compression 672-673
  - Female Compression × MIP 674
  - Female Compression x FIP 675
  - FSWT Adapters 676
- Brass Compression Tees 671-672
- Brass Compression to Flare Adapters 676
- Brass Fine Thread Flare Caps 691
- Brass Fine Thread Flare Compression Adapters 691
  - Brass Fine Thread Flare Nut 691
  - Brass Fine Thread Flare Straight Adapters 691
  - FIP 691
  - MIP 691
- Brass Flare Caps 690
- Brass Flare Couplings 687
- Brass Flare Elbow Adapters 689
  - FIP 689
  - MIP 689
- Brass Flare Elbows 688
- Brass Flare Fittings 687-691
  - Brass Fine Thread Flare Caps 691
  - Brass Fine Thread Flare Compression Adapters 691
  - Brass Fine Thread Flare Nut 691
  - Brass Fine Thread Flare Straight Adapters 691
  - Brass Flare Caps 690
  - Brass Flare Couplings 687
  - Brass Flare Elbow Adapters 689
  - Brass Flare Elbows 688
  - Brass Flare Nuts 690
  - Brass Flare Plugs 690
  - Brass Flare Reducing Couplings 687
  - Brass Flare Straight Adapters 688-689
  - Brass Flare Swivel Unions 687
  - Brass Flare Tees 687
  - Brass Flare Nuts 690
  - Brass Flare Plugs 690
  - Brass Flare Reducing Couplings 687
  - Brass Flare Straight Adapters 688-689
  - Brass Flare Swivel Unions 687
  - Brass Flare Tees 687
  - Brass Flare Nuts 690
  - Brass Flare Plugs 690
  - Brass Flare Reducing Couplings 687
  - Brass Flare Straight Adapters 688-689
  - FIP 688-689
  - MIP 688
  - Brass Flare Swivel Unions 687
  - Brass Flare Tees 687
  - Brass Garden Hose Blowout Fittings 733
  - Brass Garden Hose Cap 732
  - Brass Garden Hose Couplings 731
  - Brass Garden Hose Elbow 731
  - Brass Garden Hose Fittings 731-733
    - Brass Garden Hose Blowout Fittings 733
    - Brass Garden Hose Cap 732
    - Brass Garden Hose Couplings 731
    - Brass Garden Hose Elbow 731
    - Brass Garden Hose Straight Adapters 731-732
    - Brass Garden Hose Washer 733
    - Brass Garden Hose Wye 732
  - Brass Garden Hose Straight Adapters 731-732
    - Compression 732
    - FIP 731
    - Hose Barb 732
    - MIP 731
  - Brass Garden Hose Washer 733
  - Brass Garden Hose Wye 732
  - Brass Hose Barb Couplings 721
  - Brass Hose Barb Ferrule 722

Brass Hose Barb Fittings 721-722  
 Brass Hose Barb Couplings 721  
 Brass Hose Barb Ferrule 722  
 Brass Hose Barb Straight Adapters 721-722  
 Brass Hose Barb Valves 722  
 Brass Hose Barb Straight Adapters 721-722  
 FIP 722  
 MIP 721  
 Brass Hose Barb Valves 722  
 Brass Stop & Waste Valve 112  
 Brass Waste & Overflows 601-602  
 Chain & Stopper 602  
 Ezy Touch® 601  
 Standing Waste 602  
 Trip Lever 601  
 Twist-N-Close™ 601  
 Brushes & Abrasives 771-772  
 Abrasive Cleaning Pads 772  
 Abrasive Mesh/Cloth 772  
 Acid/Cement Brushes 771  
 Fitting Brushes 771  
 Tube OD Brush 772  
 Bullet - F1807 Stub Out 26  
 Bullet - F1960 Stub Out 54  
 Bullet - F3347 Stub Out 71  
 Bullet - Sweat 106  
 Male Sweat 106  
 MIP 106

**C**

Cable Ties 500  
 Cap - PDQ™ Push Fit 125  
 Caps 678  
 Carrier - Closet 315-318  
 Carrier - Lavatory 319  
 Carrier Bracket 537  
 Cast Brass Fittings 701-704  
 Cast Red Brass Caps 703  
 Cast Red Brass Couplings 701  
 Cast Red Brass Elbows 702  
 Cast Red Brass Hex Bushings 703  
 Cast Red Brass Hex Nipples 703  
 Cast Red Brass Locknuts 703  
 Cast Red Brass Plugs 703-704

Cast Red Brass Reducing Couplings 701  
 Cast Red Brass Straight Adapters 702  
 Cast Red Brass Street Elbows 702  
 Cast Red Brass Tees 701  
 Cast Red Brass Union Adapters 701  
 Cast Iron - FIP Connection 292  
 Cast Iron - No-Hub Connection 245-247  
 5-1/2" Tops 246  
 6-1/2" Tops 245  
 9" Tops 247  
 Cast Iron - No-Hub Connection 250-252  
 5-1/2" Tops 251-252  
 6-1/2" Tops 250-251  
 Cast Iron - No-Hub Connection 255-257  
 Cast Iron Strainer 257  
 Nickel-Bronze Ring & Strainer 255  
 Nickel-Bronze Ring & Strainer - Extended Rim 256  
 Stainless Steel Ring & Strainer 256  
 Cast Iron - No-Hub Connection 297-298  
 6-1/2" Tops 297  
 9" Tops 298  
 Cast Iron - No-Hub Connection 301-303  
 Ductile Iron Cover 302  
 Ductile Iron Cover with Nickel-Bronze Veneer 302  
 Ductile Iron Cover with Stainless Steel Veneer 303  
 Nickel-Bronze Cover 301  
 Stainless Steel Cover 301  
 Cast Iron - No-Hub Connection 306  
 Cast Iron - Push-Joint Connection 247-248  
 Cast Iron - Push-Joint Connection 252-254  
 5-1/2" Tops 254  
 6-1/2" Tops 252-253  
 Cast Iron - Push-Joint Connection 257-260  
 Cast Iron Strainer 260  
 Nickel-Bronze Ring & Strainer 257-258  
 Nickel-Bronze Ring & Strainer - Extended Rim 259  
 Stainless Steel Ring & Strainer 259  
 Cast Iron - Push-Joint Connection 298-299  
 Cast Iron - Push-Joint Connection 303-305  
 Ductile Iron Cover 304  
 Ductile Iron Cover with Nickel-Bronze Veneer 305  
 Ductile Iron Cover with Stainless Steel Veneer 305  
 Nickel-Bronze Cover 303

Stainless Steel Cover 304  
 Cast Iron - Push-Joint Connection 306  
 Cast Iron Closet Flanges 447  
 Cast Iron Floor Drains 437  
 Philadelphia Style Fresh Air Vent 437  
 Pittsburgh Style Floor Drain 437  
 St. Louis Style Floor Drain 437  
 Cast Iron Round Floor Sinks 277-278  
 12" x 8" 277  
 8" x 6" 278  
 Cast Iron Shower Drains 423  
 2-Piece Drain with Stamped Stainless Steel Strainer 423  
 3-Piece Drain with Grid-Pattern Head & Strainer 423  
 Cast Iron Square Floor Sinks 273-276  
 12" x 12" x 10" 275  
 12" x 12" x 6" 273  
 12" x 12" x 8" 274  
 8" x 8" x 6" 276  
 Cast Red Brass Caps 703  
 Cast Red Brass Couplings 701  
 Cast Red Brass Elbows 702  
 Cast Red Brass Hex Bushings 703  
 Cast Red Brass Hex Nipples 703  
 Cast Red Brass Locknuts 703  
 Cast Red Brass Plugs 703-704  
 Cast Red Brass Reducing Couplings 701  
 Cast Red Brass Straight Adapters 702  
 Cast Red Brass Street Elbows 702  
 Cast Red Brass Tees 701  
 Cast Red Brass Union Adapters 701  
 Cast Ring & Strainers 429-430  
 Round Pattern 429-430  
 Square Pattern 430  
 Center Outlets 566  
 Center Outlets 580  
 ChaseBracket™ 537  
 Cheater Vent 626  
 Chemicals 779  
 Cinch Clamp 17  
 Cinch Clamp 43  
 ClassicBox™ 3/4" Outlet 161  
 Cleanout - Commercial 369-378  
 Cleanout - Specification 297-310

Supply

Drainage

Support

Specialties

Appendix

# Alphabetical Index

Supply

Drainage

Support

Specialties

Appendix

- Cleanout Accessories 381-382
- Cleanout Bushing 378
  - Inside-Pipe Cleanout Bushing 378
  - Inside-Pipe Cleanout Fitting 378
- Cleanout Cover Accessories 377
- Cleanout Cover Kits 310
- Cleanout Cover Kits 377
- Cleanout Covers 310
- Cleanout Covers 376
  - ABS Covers 376
  - Stainless Steel Covers 376
- Cleanout Ferrules 309
- Cleanout Fittings 309
  - Cleanout Ferrules 309
  - Cleanout Tees 309
- Cleanout Plugs 311
  - Brass - Slotted 311
  - Brass - Square-Head 311
- Cleanout Plugs 379-380
  - Polypropylene - Slotted 379
  - Polypropylene - Square-Head 380
  - PVC - Spanner 380
- Cleanout Tees 309
- Clear Vinyl Tubing 647-648
  - Clear Braided 648
  - Clear Standard Tubing 647-648
- Clevis hanger 546
- Closet Bolt Cover Cap 631
- Closet Bolts 631
- Closet Bowl Gaskets 632
  - Wax 632
  - Waxless Foam 632
- Closet Carrier Accessories 317-318
- Closet Carriers 315-318
  - Closet Carrier Accessories 317-318
  - Horizontal 315-316
  - Vertical 316-317
- Closet Flange Floor Support 449
- Closet Flange Floor Support 635
- Closet Specialties 631-636
  - Closet Bolt Cover Cap 631
  - Closet Bolts 631
  - Closet Bowl Gaskets 632
  - Closet Flange Floor Support 635
  - ELJER Touch Flush KIT 634
  - Misc Closet Repair 635-636
  - PlumbPerfect™ 631
  - QuickSpacer™ 635
  - Raise-A-Ring™ 635
  - Ringer™ 634
  - Save-A-Flange™ 635
  - SmartCap™ 631
  - Tank Handles 634
  - Tank-To-Bowl Repair 633
  - Toilet Tank Fill Valves 633
  - Toilet Tank Flush Valves 633-634
  - Two-Piece Repair Ring 634
  - Wedgelt™ 632
- Cock Adapter - F1807 23
- Combination Roof Drain & Overflow 288-290
  - 10" Roof Drain & Overflow 289
  - 15" Roof Drain & Overflow - Alpha Series 288
  - 15" Roof Drain & Overflow - Bravo Series 288-289
  - 8" Roof Drain & Overflow 290
- Commercial Alignment Bracket 537
- Commercial Brackets 537-541
  - Acoustical Isolation Accessories 541
  - Acoustical TD+™ Universal Clamps 541
  - Carrier Bracket 537
  - ChaseBracket™ 537
  - Commercial Alignment Bracket 537
  - CTS Bell Hanger 537
  - Manifold Brackets 541
  - PipeTitan™ 538
  - PowerBar™ Mini Strut 538-539
  - SaddleUp™ 539
  - TD+™ Plenum-Rated Universal Clamps 540
  - TD+™ Universal Clamps 539-540
- Concealed Arm 319
- Condensate Funnel - Outlet Box 216
- Condensate Funnels 269
- Condensate Funnels 351
- Condensate Trap 461
- Cooler Fittings 746
  - Cooler Valve 746
  - FIP × MIP Adapter 746
- Copper Tube Cushion Clamps 547
- Copper Tube Cutters 761
- Coupling - F1807 19
- Coupling - F1960 50
- Coupling - F1960 Poly 64
- Coupling - F2159 44
- Coupling - PDQ™ Push Fit 124
- Coupling - Slip - PDQ™ Push Fit 124
- Coupling - Sweat 103
- CPVC - Fittings, Adapters & Connectors 79-82
  - CPVC Elbow Adapter 81
  - CPVC Straight Adapter 79-81
  - Wal-Let™ - CPVC 82
- CPVC - Sch 40 - Straight Adapter 91-92
  - F1807 91
  - F1960 91
  - FIP 92
  - Male Sweat 91
  - MIP 91
- CPVC - Sch 40 - Stub Out Elbows 92
- CPVC Brass Ball Valve 85
- CPVC Elbow Adapter 81
- CPVC Frost-Proof Anti-Siphon Sillcock 86
- CPVC Kits 87
  - CPVC Stub Out Elbow Kit 87
  - CPVC Water Heater Connector Kit 87
- CPVC Preformed Copper & Valves 83-86
  - CPVC Brass Ball Valve 85
  - CPVC Frost-Proof Anti-Siphon Sillcock 86
  - CPVC Sillcock 86
  - CPVC Stub Out Elbow 83
  - CPVC Tub/Shower Pressure Connector 83
  - CPVC Water Heater Connector 84-85
- CPVC Sillcock 86
- CPVC Straight Adapter 79-81
  - F1807 79
  - F1960 79
  - F3347 79
  - FIP 80
  - FIP Short-N-Swivel™ 81
  - Male Sweat 80
  - MIP 80
  - Press-Fitting 81

CPVC Straight Adapter - IPS Gray 91-92  
 F1807 91  
 F1960 91  
 FIP 92  
 Male Sweat 91  
 MIP 91  
 CPVC Stub Out Elbow 83  
 Square O Strap 83  
 Standard 83  
 CPVC Stub Out Elbow - IPS Gray 92  
 CPVC Stub Out Elbow Kit 87  
 1/2" Lav/Sink Stub Outs With Bracket 87  
 1/2" Water Closet Stub Out With Bracket 87  
 CPVC Tub/Shower Pressure Connector 83  
 CPVC Water Heater Connector 84-85  
 FIP Swivel Elbow 84  
 FIP Swivel Straight 84  
 Flexible Copper FIP Swivel 84-85  
 MIP Straight 85  
 T&P Relief Adapter 85  
 CPVC Water Heater Connector Kit 87  
 Crimp Ring 17  
 Crimp Ring 43  
 Crimp Ring Removal Tool 40  
 Crimp Rings 17  
 Crimp Rings 43  
 Crimp Tool 38  
 Crimping Tool 757  
 CTS Bell Hanger 537

**D**

Debris Covers 215  
 Deburring Tool 763  
 DeckAnchor™ Fixture Mounting Fitting 268  
 Deluxe Matte Stainless Ring & Strainer 418  
 Deluxe Nickel-Bronze Ring & Strainer 416  
 Deluxe Oil-Rubbed Bronze Finish Ring & Strainer 419  
 Deluxe Polished Stainless Ring & Strainer 417  
 Deluxe Satin Nickel Finish Ring & Strainer 417-418  
 Dishwasher Supply & Kits 618  
 Dishwasher Tailpieces 568-569  
 Dishwasher/Disposal Drain 625-627  
 Auto Vent 626  
 Dishwasher Adapter 626

Dishwasher Air Gaps 626  
 Disposal Drain 627  
 Drain Hose 625-626  
 Dishwasher/Disposal Drain 657  
 Disposer Waste 566-567  
 Disposer Waste 580  
 Drain Cocks 746  
 DropKick™ 446  
 DrySeal™ Pipe Collar 640  
 Dual-Fit Test Caps 472  
 DWV Backwater Valve 454

**E**

EasyClamps 741  
 Edge™ Support System 520  
 Elbow - F1807 18  
 Elbow - F1960 49  
 Elbow - F1960 Poly 63  
 Elbow - F2159 43  
 Elbow - PDQ™ Push Fit 123  
 Elbow - Stub Out - CPVC 83  
 Square O Strap 83  
 Standard 83  
 Elbow - Stub Out - F1807 25  
 Double Stub Out 25  
 Square O Strap 25  
 Elbow - Stub Out - F1960 54  
 Double Stub Out 54  
 Square O Strap 54  
 Elbow - Stub Out - F3347 71  
 Elbow - Stub Out - Sweat 103-104  
 Double Stub Out 104  
 Male Sweat Offset 104  
 Square O Strap 103  
 Elbow - Tub Spout - Sweat 105  
 Elbow Adapter 102  
 Elbow Adapter - PDQ™ Push Fit 126  
 FIP 126  
 MIP 126  
 Elbow Adapter - Sweat 102  
 Elbow Adapter - Sweat Leaded 101  
 Electronic Trap Primer 150-151  
 Recessed Box 151  
 Single Outlet Primer 151

Surface Mount Box & Panel 150  
 ELJER Touch Flush KIT 634  
 Emery Cloth 772  
 End Outlets 565-566  
 Non-Telescoping 565-566  
 Telescoping 565  
 End Outlets 579-580  
 Expander Tool 758  
 Expansion Ring - F1960 49  
 Expansion Tank Support Kits 555  
 Expansion Tools 67  
 Extension Hangers 505-506  
 Gas Vent Pipe Support 505  
 HangsTuff™ 505  
 Metal DWV Hanger 506  
 StickEm Up™ 506  
 Swivel J-Hanger™ 505  
 ZipStick™ 505-506  
 Extensions 568  
 Extensions 582  
 EZ Glide™ Suspension Clamp 488-489  
 EZ Glide™ Tube Clamp 488  
 EZ Glide™ Tube Insulator 489

**F**

F1807 Ballcock Adapter 23  
 F1807 Brass Ball Valve 28  
 F1807 Bullet™ 26  
 F1807 Coupling 19  
 F1807 Elbow 18  
 F1807 Elbow Adapter 22-23  
 3/4" FIP Swivel 22  
 Female Sweat 23  
 Male Sweat 23  
 MIP 22  
 Tub/Shower Elbow 22  
 F1807 Faucet Adapter 23  
 F1807 Frost-Proof Anti-Siphon Sillcock 28  
 F1807 Ice Maker Valve 29  
 F1807 Plug 19  
 F1807 Sillcock 28  
 F1807 Straight Adapter 19-21  
 CPVC - IPS Gray 20  
 CPVC, CTS 19

# Alphabetical Index

Supply

Female Sweat 21  
FIP 21  
Male Sweat 20  
MIP 21  
PVC 20

Drainage

F1807 Stub Out 26  
F1807 Stub Out Elbow 25  
    Double Stub Out 25  
    Square O Strap 25  
F1807 Stub Out Kit 30-31  
    1/2" Lav/Sink Stub Outs With Bracket 30  
    1/2" Shower Riser Elbow With Bracket 31  
    1/2" Water Closet Stub Out With Bracket 30

Support

    3/4" Water Heater Stub Outs With Bracket 30  
    StopOut™ 30  
F1807 Tee 18  
F1807 Tub/Shower Pressure Connector 26  
F1807 Water Heater Connector 26-27  
    FIP Swivel Elbow 26  
    FIP Swivel Straight 27  
    Flexible Copper, FIP Swivel 27

Specialties

F1807 Water Heater Connector Kit 31  
F1807 Water Loop 27  
F1960 Brass Ball Valve 56  
F1960 Brass Ball Valve 57  
F1960 Bullet™ 54  
F1960 Coupling 50  
F1960 Elbow 49  
F1960 Elbow Adapter 52-53  
    Female Sweat 53  
    Male Sweat 52  
    MIP 52  
    Tub/Shower Elbow 52  
F1960 Expansion Ring 49  
F1960 Expansion Ring 63  
F1960 Frost-Proof Anti-Siphon Sillcock 57  
F1960 Poly Coupling 64  
F1960 Poly Elbow 63  
F1960 Poly Elbow Adapter 65  
F1960 Poly Faucet Adapter 65  
F1960 Poly Plug 64  
F1960 Poly Straight Adapter 65  
F1960 Poly Tee 63-64

F1960 Sillcock 57  
F1960 Straight Adapter 50-52  
    CPVC - IPS Gray 50  
    CPVC, CTS 50  
Female Sweat 51  
FIP 52  
Male Sweat 51  
MIP 51  
PVC 50

F1960 Stub Out 54  
F1960 Stub Out Elbow 54  
    Double Stub Out 54  
    Square O Strap 54  
F1960 Stub Out Kit 58-59  
    1/2" Lav/Sink Stub Outs With Bracket 58  
    1/2" Shower Riser Elbow With Bracket 58  
    1/2" Water Closet Stub Out With Bracket 58  
    3/4" Water Heater Stub Outs With Bracket 59  
    StopOut™ 58

F1960 Tee 49  
F1960 Tools 67  
F1960 Tub/Shower Pressure Connector 55  
F1960 Water Heater Connector 55-56  
    FIP Swivel Elbow 55  
    FIP Swivel Straight 55  
    Flexible Copper FIP Swivel 56  
F1960 Water Heater Connector Kit 59  
F2159 Poly Coupling 44  
F2159 Poly Elbow 43  
F2159 Poly Elbow Adapter 45  
    FIP Swivel Elbow 45  
    MIP Elbow 45  
F2159 Poly Plug 44  
F2159 Poly Straight Adapter 45  
    FIP Swivel 45  
    MIP 45

F2159 Poly Tee 44  
F3347 Brass Ball Valve 72  
F3347 Bullet™ 71  
F3347 Straight Adapter 71  
F3347 Stub Out 71  
F3347 Stub Out Elbow 71  
F3347 Stub Out Kit 73

F3347 Tub/Shower Pressure Connector 71  
F3347 Water Heater Connector 72  
FastTrack™ Large-Capacity System 388  
FastTrack™ Low-Profile System 388-389  
FastTrack™ Pre-Sloped System 387-388  
FastTrack™ System 387-389  
    FastTrack™ Large-Capacity System 388  
    FastTrack™ Low-Profile System 388-389  
    FastTrack™ Pre-Sloped System 387-388  
FatMax™ Floor Drain Accessories 334  
FatMax™ Floor Sink Accessories 357-358  
FatMax™ Large-Capacity Floor Drains 263-265  
    12" Diameter 264-265  
    9" Diameter 263-264  
    Stainless Steel 265  
FatMax™ Large-Capacity Floor Drains 333-334  
    FatMax™ Floor Drain Accessories 334  
    LittleMax™ General Purpose Floor Drain 334  
    PVC/ABS - Sch. 40 Hub Connection 333  
FatMax™ PVC Round Floor Sink 357-358  
    FatMax™ Floor Sink Accessories 357-358  
    PVC - Sch. 40 Hub Connection 357  
Faucet Adapter - F1807 23  
Faucet Adapter - F1960 Poly 65  
Faucet Handle Puller 766  
Faucet Seat Wrenches 764  
Faucet Stem Key 764  
Ferrules 677-678  
FinishLine Halo™ Adjustable Cleanouts 308  
FinishLine Halo™ Adjustable Cleanouts 372-373  
FinishLine Halo™ Floor Drains 261-262  
FinishLine Halo™ Floor Drains 348-349  
FinishLine™ Above-Grade Floor Drains 250-254  
    Cast Iron - No-Hub Connection 250-252  
    Cast Iron - Push-Joint Connection 252-254  
FinishLine™ Above-Grade Floor Drains 335-342  
    ABS on Iron - No-Hub Connection 338-339  
    ABS on Iron - Push-Joint Connection 340-342  
    PVC/ABS - Sch. 40 Hub Connection 335-337  
FinishLine™ Adjustable Cleanouts 297-300  
    Cast Iron - No-Hub Connection 297-298  
    Cast Iron - Push-Joint Connection 298-299  
    Stainless Steel - No-Hub Connection 300

Appendix

FinishLine™ Adjustable Cleanouts 369  
 FinishLine™ On-Grade Floor Drains 245-249  
     Cast Iron - No-Hub Connection 245-247  
     Cast Iron - Push-Joint Connection 247-248  
     Stainless Steel - No-Hub Connection 249  
 FinishLine™ On-Grade Floor Drains 327-329  
 Fitting Brushes 771  
 Flaring Tool 766  
 Flat Gasket Material 665  
 Flexible Fittings 571  
 Flexible PVC Spa Hose 658  
 Flexible PVC Test Caps 472  
 Floor Drain Accessories 266-269  
     Adjustable Floor Drain Head 266-267  
     Condensate Funnels 269  
     DeckAnchor™ Fixture Mounting Fitting 268  
     Floor Drain Adapters 268-269  
     TrapShield™ 267  
 Floor Drain Accessories 350-352  
     Condensate Funnels 351  
     Floor Drain Adapters 351  
     Replacement Strainers 350  
     TrapShield™ 350  
     Vandal-Resistant Strainer Screws 352  
 Floor Drain Adapters 268-269  
     Extension Adapter 269  
     Flashing Drain Adapters - 4" FIP Thread 268  
     No-Hub Adapters 268  
     Push-Joint Adapters 268  
 Floor Drain Adapters 351  
     Flashing Drain Adapters 351  
     Trap Primer Adapters 351  
 Floor Drain Replacement Strainers 438-439  
     General-Purpose Cast Iron Strainers 439  
     Strainers for Bell Trap Drain 438  
     Strainers for City-Style Drains 438-439  
     Strainers for Weld One / Quad Drain 438  
 FlowEasy™ - Liquid Drain Cleaner 779  
 Foam Pipe/Tube Insulation 135-136  
     Half-Slit - Black 135-136  
     Self-Seal Seam - Black 135  
 Frames, Inserts, & Extensions 216  
 Freestanding Tub Drain 428

Freestanding Tub Drain 428  
 Fridge Box 165  
 Frost-Proof Anti-Siphon Sillcock 113  
 Frost-Proof Sillcock - CPVC 86  
 Frost-Proof Sillcock - F1807 28  
 Frost-Proof Sillcock - F1960 57  
 Frost-Proof Sillcock - Sweat/MIP 113  
 Frost-Proof Sillcock Replacement Parts 114  
 Fuel Line 661  
     Polyester Reinforced Fuel Line 661  
     Polyurethane Micro Fuel Line 661  
 Full Clamp 486  
 Full Slip Male Adapter 101  
 FullFlush™ 446  
     Inside-Pipe Gasket Connection 446  
     PVC/ABS Sch. 40 Hub Connection 446

**G**

Garden Hose 657  
 Gas Range Fittings 692  
 Gas Service - FIP Outlet 207  
 Gas Specialty Fittings 692  
 Gas Vent Pipe Support 505  
 Gasket Material 665  
 Gasketed Closet Flange 445  
 Gauges & Accessories 477  
     Hand Pump 477  
     Test Gauge Assemblies 477  
     Test Gauges 477  
 General-Purpose Cast Iron Strainers 439  
 General-Purpose Floor Drains 434-435  
     840 Series Floor Drains 435  
     Bell-Trap Floor Drains 435  
     QuadDrain™ 434  
 Grid-Pattern Head & Strainer 419-420  
 Gripper™ 436  
 GripTip™ 471  
 GripTip™ 473  
 Ground Stake 513

**H**

Hacksaw 762  
 Halo™ Adjustable Cleanouts 308  
 Halo™ Adjustable Cleanouts 372  
 Halo™ Cleanouts 308

FinishLine Halo™ Adjustable Cleanouts 308  
 Halo™ Adjustable Cleanouts 308  
 Halo™ Cleanouts 372-373  
     FinishLine Halo™ Adjustable Cleanouts 372-373  
     Halo™ Adjustable Cleanouts 372  
 Halo™ Floor Drains 261-262  
     FinishLine Halo™ Floor Drains 261-262  
     Halo™ Floor Drains 261  
 Halo™ Floor Drains 261  
 Halo™ Floor Drains 347-349  
     FinishLine Halo™ Floor Drains 348-349  
     Halo™ Floor Drains 347  
 Halo™ Floor Drains 347  
 Halo™ Shower Pan Drain 422  
 Hand Pump 477  
 HandTite™ 470  
 Hanger Straps 509  
     ApeTape™ 509  
     Metal Hanger Strap 509  
     Plastic Hanger Strap 509  
 HangsTuff Jr.™ 491  
 HangsTuff™ 505  
 HardHat™ 472  
 Heat Trap Loop 111  
 Heater Hose 657  
 Heavy-Duty Cleanout Housing 307  
 Horizontal 315-316  
     Bariatric (1,000 Lb) 316  
     Extra-Heavy (750 Lb) 315  
     Standard (500 Lb) 315  
 Hose 657-658  
     Dishwasher/Disposal Drain 657  
     Flexible PVC Spa Hose 658  
     Garden Hose 657  
     Heater Hose 657  
     Latex Hose 658  
     Suction/Discharge Hose 658  
 Hose Bibb - CPVC 86  
 Hose Bibb - F1807 28  
 Hose Bibb - F1960 57  
 Hose Bibb - Push Fit 129-130  
 Hose Bibb - Sweat 113  
 Hose Clamps 741

EasyClamps 741  
 Stainless Steel Hose Clamps 741  
 HydraRester™ 143-144  
 CPVC 143  
 MIP 143  
 PEX 144  
 Sweat/Press-Fit 143

HydroBlock™ 100 405  
 HydroBlock™ 150 405  
 HydroBlock™ 200 405-406  
 HydroBlock™ 300 406  
 HydroBlock™ System 405-406  
 HydroBlock™ 100 405  
 HydroBlock™ 150 405  
 HydroBlock™ 200 405-406  
 HydroBlock™ 300 406

HydroLine™ System 409  
 HydroLine™ System 409  
 HydroTec™ MAXI System 393-398  
 Maxi 100 - 4" Wide 393-394  
 Maxi 150 - 6" Wide 395-396  
 Maxi 200 - 8" Wide 397  
 Maxi 300 - 12" Wide 397-398  
 Maxi 400 - 16" Wide 398  
 HydroTec™ System 393-401  
 HydroTec™ MAXI System 393-398  
 HydroTec™ TOP System 399-401  
 HydroTec™ TOP System 399-401

**I**

Ice Maker - 1/4" Comp. Outlet 165-166  
 OxBox™ 1/4" Outlet 165  
 OxBox™ 1/4" Outlet, Fire-Rated 166  
 ProPlate™ 1/4" Outlet 166  
 Ice Maker Supply & Kits 618  
 Ice Maker Valve - F1807 29  
 Inflatable Cleanout Tee Plug 470  
 Inflatable Test Plug 471  
 Inside Pipe Cutter 762  
 Inside Pipe Drain 436  
 Inside-Pipe Cleanout Bushing 378  
 Inside-Pipe Cleanout Fitting 378  
 Inspection Mirror 766  
 Insulation - Pipe 135

Integral-Trap Floor Drains 433  
 IPS F438 CPVC - Fittings, Adapters & Connectors 91-92  
 CPVC Straight Adapter - IPS Gray 91-92  
 CPVC Stub Out Elbow - IPS Gray 92

**J**

JackRabbit™ Outer-Locknut Style 427  
 J-Clamp 485  
 J-Hook 491-505

**K**

Kitchen Supply - Comp. Multi-Valve Outlet 179-180  
 Knockout Closet Flanges 443  
 Knockout Test Plugs 472

**L**

Large-Capacity Shower Pan Drains 422  
 Latex Hose 658  
 Laundry - 3/4" Male Hose Outlet 157-161  
 ClassicBox™ 3/4" Outlet 161  
 OmniPanel™ 3/4" Outlet 160  
 OmniPanel™ 3/4" Outlet, Fire-Rated 160  
 OxBox ONE™ 3/4" Outlet 159  
 OxBox ONE™ 3/4" Outlet, Fire-Rated 159  
 OxBox™ 3/4" Outlet 157-158  
 OxBox™ 3/4" Outlet, Fire-Rated 158  
 Laundry Box 157-161  
 Lav Box - 3/8" Comp. Outlet 173-175  
 OmniPanel™ 3/8" Outlets 174  
 OmniPanel™ 3/8" Outlets, Fire-Rated 175  
 OxBox™ 3/8" Outlets - Dual valve 173  
 OxBox™ 3/8" Outlets, Fire-Rated - Dual Valve 173-174  
 OxBox™ 3/8" Outlets, TMV, Dual Outlet 174  
 Lav Sink Drains 596-597  
 CO Plug Drain 596  
 Industrial Sink Plug 597  
 PO Plug Drain 596  
 Lav/Sink Accessories 627  
 Lav/Sink Specialties 621-627  
 Dishwasher/Disposal Drain 625-627  
 Lav/Sink Accessories 627  
 Metal Escutcheons 622-624  
 Polypropylene Escutcheons 621-622  
 Sink/Faucet Repair 624-625  
 Lav/Sink Supply 617  
 Lavatory Carriers 319

Adjustable Concealed Arm 319  
 Concealed Arm 319  
 Plate Type 319

Levels 767  
 Lift & Turn 601-603  
 LittleMax™ Compact PVC Round Floor Sink 359  
 LittleMax™ General Purpose Floor Drain 334  
 Low-Density Polyethylene Tubing 653  
 Low-Profile Linear Shower Drain 425  
 Lubricants 775

**M**

MainBlock™ 490  
 Manifold - 1/2" F1807 Branches 32-37  
 1" CPVC x Spun Closed Trunk 37  
 1" F1807 x 1" F1807 Trunk 34  
 1" F1807 x Spun Closed Trunk 33  
 1" FSWT x Spun Closed Trunk 36  
 1" MSWT x 1" FSWT Trunk 36  
 1" MSWT x 1" MSWT Trunk 35  
 1" MSWT x Spun Closed Trunk 35  
 1/2" F1807 x 3/4" F1807 Trunk 33  
 1/2" F1807 x Closed Trunk 33  
 3/4" F1807 x 1" F1807 Trunk 33  
 3/4" F1807 x 3/4" F1807 Trunk 32  
 3/4" F1807 x Spun Closed Trunk 32  
 3/4" MSWT x 3/4" FSWT Trunk 34  
 3/4" MSWT x 3/4" MSWT, Extended Trunk 35  
 3/4" MSWT x Spun Closed Trunk 34  
 Manifold - 1/2" F1960 Branches 60-61  
 1" CPVC x Spun Closed Trunk 61  
 1" MSWT x 1" MSWT Trunk 61  
 1" MSWT x Spun Closed Trunk 61  
 3/4" F1960 x Spun Closed Trunk 60  
 3/4" F1960 x 3/4" F1960 Trunk 60  
 3/4" MSWT x Spun Closed Trunk 60  
 Manifold - 1/2" MIP Branches 117  
 1" MSWT x 1" FSWT Trunk 117  
 1" MSWT x 1" MSWT Trunk 117  
 Manifold - 1/2" MIP/Female Sweat Ball Valve Branches 118  
 1" MSWT x 1" FSWT Trunk 118  
 1" MSWT x 1" MSWT Trunk 118  
 Manifold - 1/2" Sweat Branches 116  
 1" MSWT x 1" FSWT Trunk 116



1" MSWT × 1" MSWT Trunk 116  
 Manifold - ¾" Male Sweat Branches 116-117  
 1-1/2" MSWT × 1-1/2" FSWT Trunk 116  
 1-1/4" MSWT × 1-1/4" MSWT Trunk 116  
 2" MSWT × 2" MSWT Trunk 117  
 Manifold - Poly - ½" F1960 Branches 66  
 1" F1960 x 1" F1960 Trunk 66  
 1" F1960 x Closed Trunk 66  
 3/4" F1960 x 3/4" F1960 Trunk 66  
 3/4" F1960 x Closed Trunk 66  
 Manifold Brackets 541  
 Match Holder 767  
 MegaRester™ 144  
 Copper 144  
 Stainless Steel 144  
 Metal Access Panel 221  
 Metal CTS/IPS 495-496  
 2-Hole Tube Strap 495  
 Milford Hanger 496  
 Natick Hanger 496  
 Vinyl-coated Steel Clamp with Screw 495  
 Wire Pipe Hook 496  
 Metal DWV Hanger 506  
 Metal Escutcheons 622-624  
 Deep Bell 623  
 Deep Box 622-623  
 Hinged Floor & Ceiling Plates 623-624  
 Shallow Escutcheons 622  
 Metal Hanger Strap 509  
 Metal Stud Punch 763  
 Metal Tubular 575-589  
 Branch Tailpieces 583-585  
 Center Outlets 580  
 Disposer Waste 580  
 End Outlets 579-580  
 Extensions 582  
 Metal Tubular Accessories 588-589  
 P-Traps 575-578  
 Sink Tailpieces 580-581  
 S-Traps 578  
 Threaded Tube 586  
 Trap Accessories 579  
 Tubular Fittings 587

Waste Arms 585  
 Metal Tubular Accessories 588-589  
 Desanco Fittings & Adapters 588-589  
 Nuts & Washers 588  
 Sink Funnel 589  
 Milford Hanger 496  
 MiniRester™ 141-142  
 Compression Tee 142  
 Female Compression Tee 142  
 Laundry Hose Tee/Toilet Fill Valve Tee 141  
 PEX Tee 142  
 Straight 141  
 Tub Shower / Stub Out Tee 141  
 MIP Thread Connection 457  
 Misc Closet Repair 635-636  
 Mixing Valve 115  
 Moen Cartridge Puller 766  
 Multi Clip 490  
 Multi-Port Tee - ½" F1807 Branches 37  
 3/4" F1807 × 3/4" F1807 Trunk 37  
 3/4" F1807 × Closed Trunk 37  
 Multi-Port Tee - ½" F1960 Branches 62  
 3/4" F1960 PEX x 3/4" F1960 PEX Trunk 62  
 3/4" F1960 PEX x Closed Trunk 62  
 Multi-Port Tee - Poly - ½" F1960 Branches 66  
 Multi-Turn Angle Stops 612  
 Multi-Turn Straight Stops 613

**N**

Natick Hanger 496  
 Needle Valves - Angled 745  
 Needle Valves - Saddle Valves 746  
 Needle Valves - Straight 745  
 Nickel-Bronze Downspout Nozzles 293  
 No-Caulk Connection 426  
 Non-Adjustable Floor Drain 332  
 Nuts & Inserts 678-679  
 Nylon Compression Fittings 683-684  
 Nylon Couplings 683  
 Nylon Elbow Adapters 684  
 Nylon Elbows 683  
 Nylon Reducing Couplings 683  
 Nylon Straight Adapters 683  
 Nylon Tees 683

Nylon Couplings 683  
 Nylon Elbow Adapters 684  
 Nylon Elbows 683  
 Nylon Garden Hose Cap 738  
 Nylon Garden Hose Couplings 737  
 Nylon Garden Hose Fittings 737-738  
 Nylon Garden Hose Cap 738  
 Nylon Garden Hose Couplings 737  
 Nylon Garden Hose Straight Adapters 737-738  
 Nylon Garden Hose Straight Adapters 737-738  
 FIP 737  
 Hose Barb 738  
 MIP 737  
 Nylon Hose Barb Couplings 725  
 Nylon Hose Barb Elbow Adapters 727  
 Nylon Hose Barb Elbows 725  
 Nylon Hose Barb Fittings 725-727  
 Nylon Hose Barb Couplings 725  
 Nylon Hose Barb Elbow Adapters 727  
 Nylon Hose Barb Elbows 725  
 Nylon Hose Barb Reducing Couplings 725  
 Nylon Hose Barb Straight Adapters 726-727  
 Nylon Hose Barb Tees 725-726  
 Nylon Hose Barb Reducing Couplings 725  
 Nylon Hose Barb Straight Adapters 726-727  
 FIP 727  
 MIP 726  
 Nylon Hose Barb Tees 725-726  
 Nylon Reducing Couplings 683  
 Nylon Straight Adapters 683  
 Nylon Tees 683  
 Nylon Thread Couplings 707  
 Nylon Thread Elbows 707  
 Nylon Thread Fittings 707-708  
 Barrel Valve Kits 707  
 Nylon Thread Couplings 707  
 Nylon Thread Elbows 707  
 Nylon Thread Hex Bushings 708  
 Nylon Thread Hex Nipples 708  
 Thread Bulkhead Union Adapters 707  
 Nylon Thread Hex Bushings 708  
 Nylon Thread Hex Nipples 708

**O**

Offset Closet Flanges 446  
 DropKick™ 446  
 FullFlush™ 446  
 Offset Riser 107  
 OmniPanel™ 3/4" Outlet 160  
   Arrester 160  
   Non-Arrester 160  
 OmniPanel™ 3/4" Outlet, Fire-Rated 160  
   Arrester 160  
   Non-Arrester 160  
 OmniPanel™ 3/8" Outlets 174  
   Arrester 174  
   Non-Arrester 174  
 OmniPanel™ 3/8" Outlets, Fire-Rated 175  
   Arrester 175  
   Non-Arrester 175  
 On-Grade Floor Drains 330-332  
   Adjustable Floor Drain 330-331  
   Adjustable Floor Drain Head 331-332  
   Non-Adjustable Floor Drain 332  
 Open Closet Flanges 444  
 Open Flanges 444  
 O-Ring Pick 766  
 Outlet Box 157-161  
 Outlet Box Accessories 215-217  
   Access Tools 217  
   Box Clips, Brackets & Supports 216  
   Boxes 215  
   Debris Covers 215  
   Frames, Inserts, & Extensions 216  
   Secondary Drainage Funnel 216  
   Valves 215  
 Overhead 545-548  
   Adjustable Swivel/Loop 545  
   Beam Clamp & Connector Products 545  
   Clevis hanger 546  
   Copper Tube Cushion Clamps 547  
   PipeEye™ Suspension Bracket 545  
   Sioux Chief Sammys - Thread Rod Anchors 548  
   Split Ring Hanger 546  
   Strut Clamps 547  
 OverUnder™ Access Panel 221  
 OxBox ONE™ 3/4" Outlet 159

Arrester 159  
 Non-Arrester 159  
 OxBox ONE™ 3/4" Outlet, Fire-Rated 159  
   Arrester With Frame 159  
   Non-Arrester With Frame 159  
 OxBox™ 1/4" Outlet 165  
   Arrester 165  
   Non-Arrester 165  
 OxBox™ 1/4" Outlet, Fire-Rated 166  
   Arrester 166  
   Non-Arrester 166  
 OxBox™ 3/4" Outlet 157-158  
   Arrester 157  
   Non-Arrester 157-158  
 OxBox™ 3/4" Outlet, Fire-Rated 158  
   Arrester 158  
   Non-Arrester 158  
 OxBox™ 3/8" Outlet, Fire-Rated - Single Valve 169-170  
   Arrester 169  
   Non-Arrester 170  
 OxBox™ 3/8" Outlets - Dual valve 173  
   Arrester 173  
   Non-Arrester 173  
 OxBox™ 3/8" Outlets, Fire-Rated - Dual Valve 173-174  
   Arrester 173  
   Non-Arrester 174  
 OxBox™ 3/8" Outlets, Multi-Valve 179-180  
   3 Valve Rough-In Outlet 179  
   3 Valve With Frame Fire-Rated Outlet 180  
   4 Valve Rough-In Outlet 179-180  
   4 Valve With Frame Fire-Rated Outlet 180  
 OxBox™ 3/8" Outlets, TMV, Dual Outlet 174  
 OxBox™ 3/8" Outlet-Single valve 169  
   Arrester 169  
   Non-Arrester 169  
 OxBox™ Gas 207  
   Fire-Rated Outlet Box 207  
   Outlet Box 207  
 OxBox™ Turbovent™ 211

**P**

PadLock™ 487  
 Panels 221  
   Metal Access Panel 221

OverUnder™ Access Panel 221  
 Plastic Access Panel 221  
 Paste Flux brush 771  
 PDQ™ Push - Fittings, Adapters & Connectors 123-126  
   Push Fit Cap 125  
   Push Fit Coupling 124  
   Push Fit Elbow 123  
   Push Fit Elbow Adapter 126  
   Push Fit Slip Coupling 124  
   Push Fit Straight Adapter 125-126  
   Push Fit Tee 123  
   Push Fit Transition Adapter 124  
   Push Fit Transition Tee 124  
 PDQ™ Push Fit Manifolds 131  
 PDQ™ Push Fitting Accessories 127  
   Poly Tube Stiffener 127  
   Push Fit Disconnect Tools 127  
   Stainless Steel Tube Stiffener 127  
 PDQ™ Push Preformed Copper & Valves 128-130  
   Add-A-Line™ 129  
   Push Fit Brass Ball Valve 129  
   Push Fit Frost-Proof Sillcock 130  
   Push Fit Sillcock 129  
   Push Fit Stub Out Elbow 128  
   Push Fit Tub/Shower Connector 128  
   Push Fit Water Heater Connector Kit 130  
   Push-Fit Water Heater Connector 128-129  
 PDQ™ Push-Fit Disconnect Tools 765  
 Peg-Board Hook 768  
 PEX A Tube - Barrier 14  
 PEX B Tube - Barrier 12-13  
   Coils 12-13  
   Sticks 12  
 PEX Ballcock Adapter - F1807 23  
 PEX Coupling - F1807 19  
 PEX Coupling - F1960 50  
 PEX Coupling - F1960 Poly 64  
 PEX Coupling - F2159 44  
 PEX Crimp Removal Tool 40  
 PEX Crimp Tools 38  
 PEX Elbow - F1807 18  
 PEX Elbow - F1960 49  
 PEX Elbow - F1960 Poly 63

- PEX Elbow - F2159 43
- PEX Elbow Adapter - F1807 22-23
  - 3/4" FIP Swivel 22
  - Female Sweat 23
  - Male Sweat 23
  - MIP 22
  - Tub/Shower Elbow 22
- PEX Elbow Adapter - F1960 52-53
  - Female Sweat 53
  - Male Sweat 52
  - MIP 52
  - Tub/Shower Elbow 52
- PEX Elbow Adapter - F1960 Poly 65
- PEX Elbow Adapter - F2159 45
  - FIP Swivel Elbow 45
  - MIP Elbow 45
- PEX Expansion Tools 67
- PEX Faucet Adapter - F1807 23
- PEX Faucet Adapter - F1960 Poly 65
- PEX Plug - F1807 19
- PEX Plug - F1960 Poly 64
- PEX Plug - F2159 44
- PEX Rings - Crimp 17
- PEX Rings - Crimp 43
- PEX Straight Adapter - F1807 19-21
  - CPVC - IPS Gray 20
  - CPVC, CTS 19
  - Female Sweat 21
  - FIP 21
  - Male Sweat 20
  - MIP 21
  - PVC 20
- PEX Straight Adapter - F1807 24
  - Compression 24
  - Polybutylene (PB) (ASTM F1380) × PEX 24
- PEX Straight Adapter - F1960 50-52
  - CPVC - IPS Gray 50
  - CPVC, CTS 50
  - Female Sweat 51
  - FIP 52
  - Male Sweat 51
  - MIP 51
  - PVC 50
- PEX Straight Adapter - F1960 Poly 65
- PEX Straight Adapter - F2159 45
  - FIP Swivel 45
  - MIP 45
- PEX Straight Adapter - F3347 71
- PEX Tee - F1807 18
- PEX Tee - F1960 49
- PEX Tee - F1960 Poly 63-64
- PEX Tee - F2159 44
- PexChair™ 525
- Philadelphia Style Fresh Air Vent 437
- PickUp Talon™ 485
- Pilot Line Breakaway Compression Nut 679
- Pipe Bore Adapter 461
- Pipe Insulation 135-136
- Pipe Nipples 711-713
  - Pipe Nipples - Chrome-Plated Yellow Brass 712
  - Pipe Nipples - Red Brass 712-713
  - Pipe Nipples - Yellow Brass 711
- Pipe Nipples - Chrome-Plated Yellow Brass 712
- Pipe Nipples - Red Brass 712-713
- Pipe Nipples - Yellow Brass 711
- Pipe Strainers 436
  - Gripper™ 436
  - Inside Pipe Drain 436
  - Replacel™ 436
- PipeEye™ 489
- PipeEye™ Suspension Bracket 545
- PipeTitan™ 538
- Pittsburgh Style Floor Drain 437
- Planter-Area Drains 366
- Plastic Access Panel 221
  - One-Piece 221
  - Two-Piece 221
- Plastic CTS - tube hangers 485-491
  - BiFolator™ 490
  - EZ Glide™ Suspension Clamp 488-489
  - EZ Glide™ Tube Clamp 488
  - EZ Glide™ Tube Insulator 489
  - HangsTuff Jr.™ 491
  - MainBlock™ 490
  - PadLock™ 487
  - PickUp Talon™ 485
- PipeEye™ 489
- Single Hole Tube Strap 491
- SiouxStrap™ 486
- Suspensulator™ 489
- TD+™ 491
- Totem™ 487
- TouchDown™ 490
- TubeTalon™ 485
- TwinTalon™ 486
- Plastic Hanger Strap 509
- Plastic Tube Cutter 40
- Plastic Tubular 563-572
  - Center Outlets 566
  - Dishwasher Tailpieces 568-569
  - Disposer Waste 566-567
  - End Outlets 565-566
  - Extensions 568
  - Flexible Fittings 571
  - Plastic Tubular Accessories 572
  - P-Traps 563-564
  - Sink Tailpiece/Extension 567
  - Sink Tailpieces 567
  - S-Traps 564
  - Trap Accessories 564
  - Tubular Fittings 570
  - Waste Arms 569
- Plastic Tubular Accessories 572
- Plastic Waste & Overflows 602-603
  - Cable Drive 602
  - Ezy Touch® 603
  - Trip Lever 602
  - Twist-N-Close™ 603
- Plate Type 319
- Plate Type 320
- Plate Type 321
- Plug - F1807 19
- Plug - F1960 Poly 64
- Plug - F2159 44
- PlumbPerfect™ 631
- Plunger 767
- PO Plug Wrench 764
- Poly Tube Cutters 761
- Poly Tube Stiffener 127

Supply

Drainage

Support

Specialties

Appendix

- Polyester Reinforced Fuel Line 661
- Polyethylene Tubing 653
- Polypropylene - Slotted 379
- Polypropylene - Square-Head 380
- Polypropylene Escutcheons 621-622
  - SnapOne™ Escutcheons 621-622
  - TrimTite™ Escutcheons 621
- Polypropylene Push-Fit Couplings 717
- Polypropylene Push-Fit Elbow Adapters 718
- Polypropylene Push-Fit Elbows 717
- Polypropylene Push-Fit Fittings 717-718
  - Polypropylene Push-Fit Couplings 717
  - Polypropylene Push-Fit Elbow Adapters 718
  - Polypropylene Push-Fit Elbows 717
  - Polypropylene Push-Fit Straight Adapters 717-718
  - Polypropylene Push-Fit Tees 717
  - Polypropylene Push-Fit Valves 718
- Polypropylene Push-Fit Straight Adapters 717-718
  - Polypropylene Push-Fit Tees 717
  - Polypropylene Push-Fit Valves 718
- Polyurethane Micro Fuel Line 661
- Pool Hose Couplings 751
- Pool Hose Fittings 751
- PowerBar™ 529-530
  - Accessories and Bulk Components 530
  - Acoustical 530
  - Universal Slider Bracket 529
- PowerBar™ Mini Strut 538-539
- PowerPex® Coil Unwinder 758
- PowerPEX® F1960 Manifolds 60-62
  - 1/2" F1960 Branch, Multi-Port Tee 62
  - 1/2" F1960 Branch, Manifold 60-61
- PowerPEX® F1960 PEX Kits 58-59
  - F1960 Stub Out Kit 58-59
  - F1960 Water Heater Connector Kit 59
- PowerPEX® F1960 Preformed Copper & Valves 54-57
  - F1960 Brass Ball Valve 56
  - F1960 Brass Ball Valve 57
  - F1960 Bullet™ 54
  - F1960 Frost-Proof Anti-Siphon Sillcock 57
  - F1960 Sillcock 57
  - F1960 Stub Out Elbow 54
  - F1960 Tub/Shower Pressure Connector 55
- F1960 Water Heater Connector 55-56
- PowerPex® Tools 757-758
  - ASTM F1807/F2159 Tools 757-758
  - ASTM F1960 Tools 758
  - PowerPex® Coil Unwinder 758
- PowerPEX® Tools 14
- PowerPEX® Tube 11-14
  - PowerPEX® Tools 14
  - Type A Oxygen Barrier PEX Tube 14
  - Type A PEX Tube 13
  - Type B Oxygen Barrier PEX Tube 12-13
  - Type B PEX Tube 11-12
- PrimePerfect™ 149
- Primers 149-151
- ProCheck™ 453
- Promenade Drain 291
- Promenade Drains 291
- ProPlate™ 1/4" Outlet 166
- ProPlate™ 3/8" Outlet 170
  - Fire-Rated Rough-In Outlet 170
  - Rough-In Outlet 170
- P-Traps 563-564
  - Repair 564
  - Reversible 563
  - Standard 563
- P-Traps 575-578
  - Adjustable Sink Trap 577
  - Deep Bell Escutcheon 576
  - Deep Box Escutcheon 576
  - Regulation 576-577
  - Repair P-Trap 578
  - Shallow Escutcheon 575
  - Swing Tee 577
  - Utility Traps 577
- Push Fit Add-A-Line™ 129
- Push Fit Ball Valve - PDQ™ - Brass 129
- Push Fit Brass Ball Valve 129
- Push Fit Cap 125
- Push Fit Cap - PDQ™ 125
- Push Fit Coupling 124
- Push Fit Coupling - PDQ™ 124
- Push Fit Disconnect Tools 127
- Push Fit Elbow 123
- Push Fit Elbow - PDQ™ 123
- Push Fit Elbow Adapter 126
  - FIP 126
  - MIP 126
- Push Fit Elbow Adapter - PDQ™ 126
  - FIP 126
  - MIP 126
- Push Fit Frost-Proof Sillcock 130
- Push Fit Sillcock 129
- Push Fit Sillcock - PDQ™ 129
- Push Fit Slip Coupling 124
- Push Fit Slip Coupling - PDQ™ 124
- Push Fit Straight Adapter 125-126
  - FIP 126
  - FIP Swivel Adapter 125
  - MIP 125
- Push Fit Straight Adapter - PDQ™ 125-126
  - FIP 126
  - FIP Swivel Adapter 125
  - MIP 125
- Push Fit Stub Out Elbow 128
- Push Fit Tee 123
- Push Fit Tee - PDQ™ 123
- Push Fit Transition Adapter 124
- Push Fit Transition Adapter - PDQ™ 124
- Push Fit Transition Tee 124
- Push Fit Transition Tee - PDQ™ 124
- Push Fit Tub/Shower Connector 128
- Push Fit Water Heater Connector Kit 130
- Push-Fit Water Heater Connector 128-129
  - FIP Swivel Straight 128
  - Straight Flexible Copper FIP Swivel 129
- Push-In Closet Flanges 445
- PushTite™ 445
- PVC - Fittings, Adapters & Connectors 95-97
  - PVC Brass Ball Valve 97
  - PVC Straight Adapter 95-96
- PVC - Sch. 40 Hub Connection 355
- PVC - Sch. 40 Hub Connection 357
- PVC - Sch. 40 Hub Connection 359
- PVC - Spanner 380
- PVC Brass Ball Valve 97
- PVC Sch. 40 Hub Connection 457

PVC Straight Adapter 95-96  
 F1807 95  
 F1960 95  
 FIP 96  
 Male Sweat 95  
 MIP 96  
 Press-Fitting and Push Fit Compatible 96  
 PVC Tube Cutter 40  
 PVC Tube Cutter - Ratchet 40  
 PVC Vent Cap 461  
 PVC/ABS - Sch. 40 Hub Connection 327-329  
 5-1/2" Tops 328-329  
 6-1/2" Tops 327-328  
 PVC/ABS - Sch. 40 Hub Connection 333  
 PVC/ABS - Sch. 40 Hub Connection 335-337  
 5-1/2" Tops 336-337  
 6-1/2" Tops 335-336  
 PVC/ABS - Sch. 40 Hub Connection 343-344  
 5-1/2" Tops 344  
 6-1/2" Tops 343  
 PVC/ABS - Sch. 40 Hub Connection 366  
 PVC/ABS - Sch. 40 Hub Connection 369  
 PVC/ABS - Sch. 40 Hub Connection 370  
 PVC/ABS - Sch. 40 Hub Connection 374

**Q**

QuadDrain™ 434  
 2x3 PVC/ABS Sch. 40 Hub 434  
 Full-Slip Hub Connection 434  
 Quarter-Turn Bar Stock 609  
 Quarter-Turn Forged Angle Stops 610  
 Quarter-Turn Forged Straight Stops 611  
 Quick Connect 123-131  
 QuickPlug™ 473  
 QuickSpacer™ 448  
 QuickSpacer™ 635

**R**

Raise-A-Ring™ 448  
 Raise-A-Ring™ 635  
 Ratchet Tube Cutter 40  
 Ratcheting Offset Box Wrenches 763  
 RealTite™ 468-469  
 Reducing Hex Nipples 696  
 Relief Valve - CPVC 84

Relief Valve - F1807 27  
 Relief Valve - F1960 55  
 Relief Valve - Sweat 112  
 Repair Flange 445  
 Replacelt™ 436  
 Replacement Cleanout Covers 381-382  
 Cast Iron Covers 382  
 Gray ABS Covers 382  
 Nickel Bronze Covers 381  
 Stainless Steel Covers 382  
 Tenz-Alloy Covers 381  
 Replacement Strainers 350  
 Ring - F1960 49  
 Ringer™ 448  
 Ringer™ 634  
 Rings - PEX Crimp 17  
 Rings - PEX Crimp 43  
 Riser 617  
 Riser - Sweat 107  
 Riser Stub Out 107  
 Roof Drain & Overflow 365  
 Roof Drain Accessories 293  
 Nickel-Bronze Downspout Nozzles 293  
 Stainless Steel Downspout Nozzle Cover 293  
 Vent Cap 293  
 Roof Drains 283-287  
 10" Roof Drain 286  
 10" Weir Roof Drain 286  
 11" Roof Drain 285  
 15" Adjustable Weir Roof Drain 284-285  
 15" Roof Drain - Alpha Series 283  
 15" Roof Drain - Bravo Series 283-284  
 20" Large-Capacity Roof Drain 287  
 8" Roof Drain 286  
 Roof Drains 363-364  
 10" Roof Drain 364  
 11" Roof Drain 363  
 Roof Top Block 542  
 Roof Top Support 542  
 Round Floor Sinks 280

**S**

SaddleUp™ 539  
 SafeFlame™ Protection Pad 767

Sand Cloth 772  
 Save-A-Flange™ 448  
 Save-A-Flange™ 635  
 SawHorse™ Mini Hacksaws 762  
 SawHorse™ Multi-Purpose Saws 761  
 Screwdrivers 765  
 Screw-On Stainless Steel Strainer 415  
 Screw-On Strainers 429  
 Scupper Drains 292  
 Sealants 775  
 Cement Stop Leak 775  
 Oakum 775  
 Sealants, Lubricants, & Tapes 775  
 Lubricants 775  
 Sealants 775  
 Tapes 775  
 Secondary Drainage Funnel 216  
 Secure-All™ 520  
 ServiceBox™ - Dual Valve 187  
 ServiceBox™ - Pressure Reducing Valve 191  
 Less Drain 191  
 with Drain 191  
 ServiceBox™ - Single Valve 183  
 ServiceBox™ - Single Valve Termination Outlet 199  
 ServiceBox™ - Water Heater 195  
 Flow-Thru with Cold-Side valve 195  
 Termination with Cold-Side valve 195  
 ServiceBox™ - Water Softener Outlet 203  
 Set Screw Connection 375  
 Shallow Access 454  
 Backup Float Valve 454  
 DWV Backwater Valve 454  
 Shallow-or-Deep Access 453  
 Shield Plate 552  
 Shower Arm Installation Tool 764  
 Shower Arm Test Plug 473  
 Shower Arms & Escutcheons 640  
 Shower Drain Replacement Strainers 429-430  
 Cast Ring & Strainers 429-430  
 Screw-On Strainers 429  
 Snap-In Strainers 429  
 Shower Heads 641  
 Shower Module Drains 426-427

- 825 Series - Offset Receptor-Base Style 426
- 825 Series - Receptor-Base Style 426
- 826 Series - Outer-Locknut Style 427
- JackRabbit™ Outer-Locknut Style 427
- No-Caulk Connection 426
- Shower Pan Drains 415-423
  - Adjustable Slab Shower Drain 421
  - Cast Iron Shower Drains 423
  - Deluxe Matte Stainless Ring & Strainer 418
  - Deluxe Nickel-Bronze Ring & Strainer 416
  - Deluxe Oil-Rubbed Bronze Finish Ring & Strainer 419
  - Deluxe Polished Stainless Ring & Strainer 417
  - Deluxe Satin Nickel Finish Ring & Strainer 417-418
  - Grid-Pattern Head & Strainer 419-420
  - Halo™ Shower Pan Drain 422
  - Large-Capacity Shower Pan Drains 422
  - Screw-On Stainless Steel Strainer 415
  - Snap-In Stainless Steel Strainer 415-416
  - Tile-Insert Strainer 420-421
- Shower Riser 107
- Shower Riser Kits - Sweat 119
- Shower WallNut™ 640
- Shower WallNut™ Removal Tool 766
- Shower-Up&trade; Kits - Sweat 119
- Shutoff Cocks 747
- SideWinder™ 525
- Sillcock 113
- Sillcock - CPVC 86
- Sillcock - F1807 28
- Sillcock - F1960 57
- Sillcock - Frost-Proof - CPVC 86
- Sillcock - Frost-Proof - F1807 28
- Sillcock - Frost-Proof - F1960 57
- Sillcock - Frost-Proof - Sweat/MIP 113
- Sillcock - Frost-Proof Replacement Parts 114
- Sillcock - PDQ™ Push Fit 129
- Simple Bend Support 525
- SimpleStrap™ 533
- Single Hole Tube Strap 491
- Sink Tailpiece/Extension 567
- Sink Tailpieces 567
- Sink Tailpieces 580-581
- Sink/Faucet Repair 624-625
- Faucet Aerators 624
- Faucet Hole Covers 624
- Kitchen Hose Spray 625
- NoPutty™ Gaskets 625
- O-Rings 624
- Sioux Chief Sammys - Thread Rod Anchors 499
- Sioux Chief Sammys - Thread Rod Anchors 548
- SiouxStrap™ 486
- Site-Adjustable Linear Shower Drain 425
- Slab Manifold - ½" F1807 Branches 37
  - ¾" F1807 × ¾" F1807 Trunk 37
  - ¾" F1807 × Closed Trunk 37
- Slab Manifold - ½" F1960 Branches 62
  - ¾" F1960 PEX × ¾" F1960 PEX Trunk 62
  - ¾" F1960 PEX × Closed Trunk 62
- Slab Manifold - Poly - ½" F1960 Branches 66
- Sleeve - F1960 49
- Slider™ 533
- Slip-Joint Pliers 763
- SmartCap™ 631
- SmartSaddle™ 461
- Snap-In Stainless Steel Strainer 415-416
- Snap-In Strainers 429
- Solder Straps 522
- Spacer & Repair Rings 448-449
  - Closet Flange Floor Support 449
  - QuickSpacer™ 448
  - Raise-A-Ring™ 448
  - Ringer™ 448
  - Save-A-Flange™ 448
  - Two-Piece Repair Ring 448
- Specialty Flanges 447
  - Brass Closet Flange Rings 447
  - Cast Iron Closet Flanges 447
  - Urinal Flange Kit 447
- Split Ring Hanger 546
- Splitter 149
  - Distributor 149
  - Wye Splitter 149
- Square Access Panels 310
- SquareMax™ Floor Sink Accessories 356
- SquareMax™ PVC Square Floor Sink 355-356
  - PVC - Sch. 40 Hub Connection 355
  - SquareMax™ Floor Sink Accessories 356
- St. Louis Style Floor Drain 437
- Stainless Steel 265
- Stainless Steel - No-Hub Connection 249
- Stainless Steel - No-Hub Connection 300
- Stainless Steel Bands 500
- Stainless Steel Downspout Nozzle Cover 293
- Stainless Steel Hose Clamps 741
- Stainless Steel Linear Shower Drain 424
- Stainless Steel Round Floor Sinks 280
- Stainless Steel Square Floor Sinks 279
- Stainless Steel Tube Stiffener 127
- StainlessStar™ 500
- StickEm Up™ 506
- Stop & Waste Valve 112
- Stop Valve 609-613
- Straight Adapter 24
  - Compression 24
  - Polybutylene (PB) (ASTM F1380) × PEX 24
- Straight Adapter - PDQ™ Push Fit 125-126
  - FIP 126
  - FIP Swivel Adapter 125
  - MIP 125
- Straight Adapter - Sch 40 CPVC 91-92
  - F1807 91
  - F1960 91
  - FIP 92
  - Male Sweat 91
  - MIP 91
- Strainers for Bell Trap Drain 438
- Strainers for City-Style Drains 438-439
- Strainers for Weld One / Quad Drain 438
- Strap Wrench 764
- S-Traps 564
- S-Traps 578
- StreamLine™ Linear Shower Pan Drains 424-425
  - Low-Profile Linear Shower Drain 425
  - Site-Adjustable Linear Shower Drain 425
  - Stainless Steel Linear Shower Drain 424
- StrongArm™ 519-520
  - LockBlock™ or PEX Bend LockBlock™ 519
  - Shower WallNut™ LockBlock™ 520
  - Vent Support 520

- Strut Clamps 547
- Stub Out - F1807 26
- Stub Out - F1960 54
- Stub Out - F3347 71
- Stub Out - Sweat 106
  - Male Sweat 106
  - MIP 106
- Stub Out Bracket 521
- Stub Out Bracket with Stud Guard 521
- Stub Out Brackets 519-522
  - Edge™ Support System 520
  - Secure-All™ 520
  - Solder Straps 522
  - StrongArm™ 519-520
  - Stub Out Bracket 521
  - Stub Out Bracket with Stud Guard 521
- Stub Out Elbow - CPVC 83
  - Square O Strap 83
  - Standard 83
- Stub Out Elbow - F1807 25
  - Double Stub Out 25
  - Square O Strap 25
- Stub Out Elbow - F1960 54
  - Double Stub Out 54
  - Square O Strap 54
- Stub Out Elbow - F3347 71
- Stub Out Elbow - PDQ™ Push Fit 128
- Stub Out Elbow - Sweat 103-104
  - Double Stub Out 104
  - Male Sweat Offset 104
  - Square O Strap 103
- Stub Out Elbows - Sch 40 CPVC 92
- Stub Out Kits - CPVC 87
  - 1/2" Lav/Sink Stub Outs With Bracket 87
  - 1/2" Water Closet Stub Out With Bracket 87
- Stub Out Kits - F1807 30-31
  - 1/2" Lav/Sink Stub Outs With Bracket 30
  - 1/2" Shower Riser Elbow With Bracket 31
  - 1/2" Water Closet Stub Out With Bracket 30
  - 3/4" Water Heater Stub Outs With Bracket 30
  - StopOut™ 30
- Stub Out Kits - F1960 58-59
  - 1/2" Lav/Sink Stub Outs With Bracket 58
- 1/2" Shower Riser Elbow With Bracket 58
- 1/2" Water Closet Stub Out With Bracket 58
- 3/4" Water Heater Stub Outs With Bracket 59
- StopOut™ 58
- Stub Out Kits - F3347 73
- Stud Guard 551
  - Metal Studs 551
  - Self-Nailing 551
- Stud Guards & Safety Plates 551-552
  - Shield Plate 552
  - Stud Guard 551
  - Stud Shoe 551
- Stud Shoe 551
- Suction/Discharge Hose 658
- Supply Stops & Kits 609-613
  - Add-A-Valve Fitting 613
  - Multi-Turn Angle Stops 612
  - Multi-Turn Straight Stops 613
  - Quarter-Turn Bar Stock 609
  - Quarter-Turn Forged Angle Stops 610
  - Quarter-Turn Forged Straight Stops 611
- Supply Tubes 617-618
  - Dishwasher Supply & Kits 618
  - Ice Maker Supply & Kits 618
  - Lav/Sink Supply 617
  - Toilet Supply 617
  - Washers & Gaskets 618
- Support Bracket 534
- Suspension Clamp 488-489
- Suspensulator™ 489
- Sweat - Fittings, Adapters & Connectors 101-102
  - Elbow Adapter 102
  - Full Slip Male Adapter 101
  - Sweat Dielectric Union 102
  - Sweat Elbow Adapter 101
  - Wal-Let™ 101
- Sweat Brass Ball Valve 112
- Sweat Bullet™ 106
  - Male Sweat 106
  - MIP 106
- Sweat Coupling 103
- Sweat Dielectric Union 102
- Sweat Elbow Adapter 101
- Sweat Kits 119
  - Sweat Shower-Up™ Kit 119
  - Sweat Water Heater Connector Kit 119
- Sweat Manifolds 116-118
  - 1/2" Male Sweat Branch, Manifold 116
  - 1/2" MIP Branch, Manifold 117
  - 1/2" MIP/FSWT Ball Valve Branch, Manifold 118
  - 3/4" Female Sweat Branch, Manifold 117
  - 3/4" Male Sweat Branch, Manifold 116-117
- Sweat Preformed Copper & Valves 103-115
  - Adapters 110
  - Add-A-Line™ 111
  - Brass Boiler Drain 113
  - Brass Stop & Waste Valve 112
  - Frost-Proof Anti-Siphon Sillcock 113
  - Frost-Proof Sillcock Replacement Parts 114
  - Heat Trap Loop 111
  - Riser Stub Out 107
  - Sillcock 113
  - Sweat Brass Ball Valve 112
  - Sweat Bullet™ 106
  - Sweat Coupling 103
  - Sweat Stub Out Elbow 103-104
  - Sweat Tub Spout Elbow 105
  - Sweat Tub/Shower Pressure Connector 106
  - Termination Fitting 103
  - Thermostatic Mixing Valve 115
  - Vacuum Breaker 114
  - Water Heater Connector 107-110
  - Water Heater Stub Out Loop 111
  - Water Meter Adapters 112
  - Water Service Connectors 111
  - Water Softener Connector 110
- Sweat Shower-Up™ Kit 119
- Sweat Stub Out 106
  - Male Sweat 106
  - MIP 106
- Sweat Stub Out Elbow 103-104
  - Double Stub Out 104
  - Male Sweat Offset 104
  - Square O Strap 103
- Sweat Tub Spout Elbow 105
- Sweat Tub/Shower Pressure Connector 106

Supply

Drainage

Support

Specialties

Appendix

# Alphabetical Index

Supply

Sweat Water Heater Connector Kit 119  
Sweat/MIP Adapter 101  
Swivel J-Hanger™ 505

## T

Drainage

Tank Handles 634  
Tank-To-Bowl Repair 633  
Tapes 775  
    Duct Tape 775  
    Pipe Thread Tape 775

Support

T-Cone™ 467  
TD+™ 491  
TD+™ Plenum-Rated Universal Clamps 540  
TD+™ Universal Clamps 539-540  
Tee - Add-A-Line™ 111  
Tee - Add-A-Line™ - PDQ™ Push Fit 129  
Tee - F1807 18  
Tee - F1960 49  
Tee - F1960 Poly 63-64  
Tee - F2159 44  
Tee - Ice Maker Valve - F1807 29  
Tee - PDQ™ Push Fit 123  
Tee - Transition - PDQ™ Push Fit 124  
TeePee™ 470

Specialties

Telescoping Basin Wrench 763  
Termination Fitting 103  
Test Devices 467-473  
    Dual-Fit Test Caps 472  
    Flexible PVC Test Caps 472  
    GripTip™ 471  
    GripTip™ 473  
    HandTite™ 470  
    HardHat™ 472  
    Inflatable Cleanout Tee Plug 470  
    Inflatable Test Plug 471  
    Knockout Test Plugs 472  
    QuickPlug™ 473  
    RealTite™ 468-469  
    Shower Arm Test Plug 473  
    T-Cone™ 467  
    TeePee™ 470  
    TestTitan™ 467  
Test Gauge Assemblies 477  
Test Gauges 477

Appendix

Testable Closet Flange 443  
TestTitan™ 467  
Thermostatic Mixing Valve 115  
Thread Bulkhead Union Adapters 707  
Threaded Tube 586  
Through-Floor Protective Sleeve 525  
Tie-Down Straps 767  
Tile-Insert Strainer 420-421  
TKO™ 443  
TMV 115  
Toilet Bolts 631  
Toilet Supply 617  
Toilet Tank Fill Valves 633  
    Anti-Siphon 633  
    Governor™ 633  
Toilet Tank Flush Valves 633-634  
Toilet/Dishwasher Box - 3/8" Comp. Outlet 169-170  
    OxBox™ 3/8" Outlet, Fire-Rated - Single Valve 169-170  
    OxBox™ 3/8" Outlet-Single valve 169  
    ProPlate™ 3/8" Outlet 170  
Tomahawk™ 513  
Tools & Accessories 761-768  
    Access Grommet Removal Tool 765  
    Allen Wrench Set 763  
    Bin Boxes 768  
    Copper Tube Cutters 761  
    Deburring Tool 763  
    Faucet Handle Puller 766  
    Faucet Seat Wrenches 764  
    Faucet Stem Key 764  
    Flaring Tool 766  
    Inside Pipe Cutter 762  
    Inspection Mirror 766  
    Levels 767  
    Match Holder 767  
    Metal Stud Punch 763  
    Moen Cartridge Puller 766  
    O-Ring Pick 766  
    PDQ™ Push-Fit Disconnect Tools 765  
    Peg-Board Hook 768  
    Plunger 767  
    PO Plug Wrench 764  
    Poly Tube Cutters 761

Ratcheting Offset Box Wrenches 763  
SafeFlame™ Protection Pad 767  
SawHorse™ Mini Hacksaws 762  
SawHorse™ Multi-Purpose Saws 761  
Screwdrivers 765  
Shower Arm Installation Tool 764  
Shower WallNut™ Removal Tool 766  
Slip-Joint Pliers 763  
Strap Wrench 764  
Telescoping Basin Wrench 763  
Tie-Down Straps 767  
Tub/Shower Socket Set 765  
Utility Knife 761  
Water Heater Element Wrench 765  
Wire Cable Saw 762  
Work Gloves 767  
Totem™ 487  
TouchDown™ 490  
Transition Adapter - PDQ™ Push Fit 124  
Transition Tee - PDQ™ Push Fit 124  
Trap Accessories 564  
Trap Accessories 579  
Trap Primer Adapter 150  
Trap Primers 149-151  
    Electronic Trap Primer 150-151  
    PrimePerfect™ 149  
    Splitter 149  
    Trap Primer Adapter 150  
    TrapEase™ 150  
    TrapShield™ 151  
TrapEase™ 150  
TrapShield™ 151  
TrapShield™ 267  
TrapShield™ 350  
Trench Drains 387-406  
Tub Spout Elbow - Sweat 105  
Tub Spouts 639  
    SmartSpout™ 639  
    Standard 639  
Tub/Shower Pressure Connector - CPVC 83  
Tub/Shower Pressure Connector - F1807 26  
Tub/Shower Pressure Connector - F1960 55  
Tub/Shower Pressure Connector - F3347 71



Tub/Shower Pressure Connector - Sweat 106  
 Tub/Shower Socket Set 765  
 Tub/Shower Specialties 639-641  
     Add-A-Shower 641  
     DrySeal™ Pipe Collar 640  
     Shower Arms & Escutcheons 640  
     Shower Heads 641  
     Shower WallNut™ 640  
     Tub Spouts 639  
 Tube Clamp 488  
 Tube Cutter - Plastic 40  
 Tube Cutter - Ratchet 40  
 Tube Insulator 489-490  
 Tube OD Brush 772  
 Tube Stiffener 39  
 TubeTalon™ 485  
 Tubing - PEX 11-14  
 Tubing - Vinyl 647-649  
 Tubular Fittings 570  
 Tubular Fittings 587  
 TurboVent™ 457-458  
     ABS Sch. 40 Hub Connection 458  
     Accessories 458  
     MIP Thread Connection 457  
     PVC Sch. 40 Hub Connection 457  
 TwinTalon™ 486  
 Two-Piece Repair Ring 448  
 Two-Piece Repair Ring 634  
 Type A Oxygen Barrier PEX Tube 14  
 Type A PEX Tube 13  
     Coils 13  
     Sticks 13  
 Type B Oxygen Barrier PEX Tube 12-13  
     Coils 12-13  
     Sticks 12  
 Type B PEX Tube 11-12  
     Coils 11-12  
     Sticks 11

**U**

Universal Brackets 529-530  
 Urinal Carriers 320  
 Urinal Flange Kit 447  
 Utility Knife 761

**V**

VacuRester™ 145  
 Vacuum Breaker 114  
 Valve - Add-A-Line™ 111  
 Valve - CPVC - Brass 85  
 Valve - F1807 - Brass 28  
 Valve - F1960 - Brass 56  
 Valve - F3347 - Brass 72  
 Valve - Ice Maker - F1807 29  
 Valve - PDQ™ Push Fit - Brass 129  
 Valve - PVC - Brass 97  
 Valve - Sweat - Brass 112  
 Valves 215  
 Valves & Cocks 745-747  
     Cooler Fittings 746  
     Drain Cocks 746  
     Needle Valves - Angled 745  
     Needle Valves - Saddle Valves 746  
     Needle Valves - Straight 745  
     Shutoff Cocks 747  
 Vandal-Resistant Strainer Screws 352  
 Vent Cap 293  
 Vertical 316-317  
     Bariatric (1,000 Lb) 317  
     Extra-Heavy (750 Lb) 317  
     Standard (500 Lb) 316  
 Vinyl Tubing 647-649  
     Black Vinyl Tubing 649  
     Clear Vinyl Tubing 647-648  
 Vinyl-coated Steel Clamp with Screw 495  
 V-Sleeve™ 17  
 V-Sleeve™ 43  
 V-Sleeve™ Compression Tool 40

**W**

Wall Cleanouts 310  
     Cleanout Cover Kits 310  
     Cleanout Covers 310  
     Square Access Panels 310  
 Wall Cleanouts 376-377  
     Cleanout Cover Accessories 377  
     Cleanout Cover Kits 377  
     Cleanout Covers 376  
 Wall Termination Fitting - CPVC 82

Wall Termination Fitting - Sweat 101  
 Wal-Let™ 101  
 Wal-Let™ - CPVC 82  
 Wal-Let™ - F1960 53  
 Washers & Gaskets 618  
 Washing Machine Box 157-161  
 Waste Arms 569  
 Waste Arms 585  
 Water Cooler Carriers 321  
 Water Hammer Arrester - HydraRester™ 143-144  
     CPVC 143  
     MIP 143  
     PEX 144  
     Sweat/Press-Fit 143  
 Water Hammer Arrester - MegaRester™ 144  
     Copper 144  
     Stainless Steel 144  
 Water Hammer Arrester - MiniRester™ 141-142  
     Compression Tee 142  
     Female Compression Tee 142  
     Laundry Hose Tee/Toilet Fill Valve Tee 141  
     PEX Tee 142  
     Straight 141  
     Tub Shower / Stub Out Tee 141  
 Water Hammer Arresters 141-145  
     HydraRester™ 143-144  
     MegaRester™ 144  
     MiniRester™ 141-142  
     VacuRester™ 145  
 Water Heater Accessories 555  
     Expansion Tank Support Kits 555  
     Water Heater Stand 555  
 Water Heater Connector 107-110  
     Corrugated Flexible SS Connectors 110  
     Female Sweat × FIP Elbow 107  
     FIP Swivel × Full-Slip Female Sweat 108  
     FIP Swivel × Male Sweat 108  
     FIP Swivel Elbow 108  
     FIP Swivel With Expansion Tank Branch 109  
     Flexible Copper Water Heater Connector 109  
     Valved With Expansion Tank Branch, Full Port 109  
 Water Heater Connector - CPVC 84-85  
     FIP Swivel Elbow 84

# Alphabetical Index

## Supply

FIP Swivel Straight 84  
Flexible Copper FIP Swivel 84-85  
MIP Straight 85  
T&P Relief Adapter 85

ZipStick™ 505-506

## Drainage

Water Heater Connector - F1807 26-27  
FIP Swivel Elbow 26  
FIP Swivel Straight 27  
Flexible Copper, FIP Swivel 27  
Water Heater Connector - F1960 55-56  
FIP Swivel Elbow 55  
FIP Swivel Straight 55  
Flexible Copper FIP Swivel 56

## Support

Water Heater Connector - F3347 72  
Water Heater Connector Kit - CPVC 87  
Water Heater Connector Kit - F1807 31  
Water Heater Connector Kit - F1960 59  
Water Heater Connector Kits - Sweat 119  
Water Heater Element Wrench 765  
Water Heater Loops 27  
Water Heater Stand 555

## Specialties

Water Heater Stub Out Loop 111  
Water Meter Adapters 112  
Water Service - Dual Valve 187  
Water Service - PRV 191  
Water Service - Single Valve 183  
Water Service - Termination Box 199  
Water Service - Water Heater 195  
Water Service - Water Softener 203  
Water Service Connectors 111  
Water Softener Connector 110  
Wedgelt™ 632  
WeldOne™ 433  
WiderSlider™ 533  
Wire Cable Saw 762  
Wire Pipe Hook 496  
Wobble Wedges 632  
Work Gloves 767

## Appendix

### Y

Y Splitter 149  
Distributor 149  
Wye Splitter 149

### Z

Zip Ties 500

Item No	Page No	Min Qty	Case Qty	UPC Bar-Coded	UPC 6-Digit	Weight (lbs.)	Item No	Page No	Min Qty	Case Qty	UPC Bar-Coded	UPC 6-Digit	Weight (lbs.)
111-G22	112	10	100	No	203502	0.51	119-0908	114	10	10	No	566287	0.1257
111-G23	112	10	100	No	203526	0.78	119-0910	114	10	10	No	566294	0.1426
113-32	113	10	100	Yes	500144	0.523	119-0912	114	10	10	No	566300	0.1693
113-33	113	10	100	Yes	500151	0.552	119-10	114	6	6	Yes	566317	0.0877
117-03	114	20	240	Yes	500182	0.2423	119-204	113	1	25	No	518811	1.5395
117-12	113	10	100	No	200655	0.68	119-206	113	1	25	No	518828	1.5454
117-C22	86	25	25	No	400055	0.6455	119-208	113	1	25	No	518835	1.55
117-C223E	86	25	25	No	400277	0.554	119-210	113	1	25	No	518842	1.744
117Q22	129	6	6	Yes	408310	0.7917	119-210CPK	113	5	5	Yes	518859	2.0337
117S2	113	10	100	Yes	711472	0.4755	119-212	113	1	25	No	518873	1.8096
117W2	57	10	100	Yes	711489	-	119-C208	86	5	5	No	406163	1.55
117X2	28	10	100	Yes	711496	0.497	119-C210	86	5	5	No	406170	1.6524
118-01	114	12	12	No	500007	0.077	119Q208	130	5	5	No	421838	1.53
118-02	114	12	12	No	500212	0.0072	119Q210	130	5	5	No	421821	1.62
118-03	114	1	1	No	500229	0.013	119X204P	28	2	2	No	518880	1.45
118-04	114	12	100	No	500236	0.006	119X206P	28	5	5	No	518897	1.4828
118-05	114	12	12	No	506672	0.001	119X208P	28	5	5	No	518903	1.535
118-06	114	1	1	No	500342	0.0035	119X210P	28	5	5	No	518910	1.65
118-07	114	1	1	No	500441	0.045	119X212P	28	5	5	No	518927	1.678
118-08	114	1	100	No	500274	0.027	120-TM3F	115	1	10	Yes	733962	-
118-0904	114	1	1	No	500281	0.116	120-TM3F-1	115	1	500	Yes	735775	-
118-0906	114	1	1	No	500298	0.14	120-TM3F-1	174	1	500	Yes	735775	-
118-0908	114	1	1	No	500304	0.158	120-TM3F-2	115	1	300	Yes	735744	-
118-0910	114	1	1	No	500311	0.176	120-TM3F-2	174	1	300	Yes	735744	-
118-0912	114	1	1	No	500328	0.305	120-TM3F-3	115	1	500	Yes	735768	-
118-C208	86	5	5	No	400390	0.7688	120-TM3F-3	174	1	500	Yes	735768	-
118M204	113	1	40	Yes	401779	1.37	129-G1C1C	609	24	144	Yes	502391	0.2465
118M206	113	1	40	Yes	401830	1.2525	129-G1F1C	609	24	144	Yes	502360	0.2778
118M208	113	1	40	Yes	401885	1.3475	129-G1RETRO	609	24	144	Yes	502353	0.2597
118M210	113	1	40	Yes	402004	1.415	129-G2C0C	609	24	144	Yes	502346	0.3031
118M212	113	2	40	Yes	402028	1.6562	129-G2C1C	609	24	144	Yes	502339	0.2958
118W204	57	1	40	Yes	402202	1.1425	129-G2F1C	609	24	144	Yes	502322	0.284
118W206	57	1	40	Yes	402226	1.2225	129-G2S1C	609	24	144	Yes	502315	0.2399
118W208	57	1	40	Yes	402301	1.3162	129-G2V1C	609	24	144	Yes	502308	0.2917
118W210	57	1	40	Yes	402325	1.4038	129-G2W0C	609	24	144	Yes	502292	0.2361
118W212	57	1	40	Yes	402349	1.4975	129-G2W1C	609	24	144	Yes	204844	0.2134
118X204	28	1	40	Yes	402080	1.1338	129-G2X0C	609	24	144	Yes	502285	0.2309
118X206	28	1	40	Yes	402103	1.2288	129-G2X1C	609	24	144	Yes	502278	0.2292
118X208	28	1	40	Yes	402141	1.3062	130-G1F1C	609	24	144	Yes	502261	0.2792
118X210	28	1	40	Yes	402165	1.4025	130-G2C0C	609	24	144	Yes	502254	0.3083
118X212	28	2	40	Yes	402189	1.505	130-G2C1C	609	24	144	Yes	502223	0.2997
119-00	114	25	25	No	566195	0.0144	130-G2F1C	609	24	144	Yes	502216	0.309
119-01	114	10	10	No	566652	0.0957	130-G2S1C	609	24	144	Yes	502209	0.2378
119-03	114	10	10	No	566218	0.0699	130-G2V1C	609	24	144	Yes	502193	0.292
119-04	114	25	25	No	566225	0.0087	130-G2W0C	609	24	144	Yes	502186	0.2583
119-07	114	1	100	No	566232	0.136	130-G2W1C	609	24	144	Yes	204851	0.2321
119-08	114	6	6	No	566249	0.0858	130-G2X0C	609	24	144	Yes	502179	0.2434
119-08C	114	6	6	No	566256	0.0851	130-G2X1C	609	24	144	Yes	502162	0.2372
119-0904	114	10	10	No	566263	0.0844	131-G0Y3HR101	611	5	60	Yes	722331	0.2283
119-0906	114	10	10	No	566270	0.1043	131-G1F1C04	611	20	240	Yes	450722	0.21

Supply

Drainage

Support

Specialties

Appendix

# Numerical Index

Supply

Drainage

Support

Specialties

Appendix

Item No	Page No	Min Qty	Case Qty	UPC Bar-Coded	UPC 6-Digit	Weight (lbs.)	Item No	Page No	Min Qty	Case Qty	UPC Bar-Coded	UPC 6-Digit	Weight (lbs.)
131-G1Q1C04	611	<b>32</b>	32	Yes	450739	0.3109	<b>134-G2C1C1CDHR104</b>	612	1	50	Yes	450883	0.651
131-G2C1C04	611	<b>20</b>	240	Yes	450746	0.2706	<b>134-G2C1C1CR104</b>	612	1	30	Yes	450890	0.295
131-G2C1C09	611	<b>50</b>	50	Yes	449313	0.27	<b>134-G2C1CE504</b>	612	1	50	Yes	461421	0.255
131-G2F1C04	611	<b>20</b>	240	Yes	450760	0.2385	<b>134-G2C1CLK04</b>	612	1	50	Yes	451187	0.373
131-G2Q1C04	611	<b>32</b>	32	Yes	502711	0.2391	<b>134-G2C1CR104</b>	612	<b>50</b>	50	Yes	451194	0.262
131-G2S1C04	611	<b>20</b>	240	Yes	450777	0.2298	<b>134-G2C2C04</b>	612	<b>50</b>	50	Yes	451200	0.265
131-G2S1CE504	611	<b>10</b>	120	Yes	450784	0.3754	<b>134-G2C2M04</b>	612	<b>50</b>	50	Yes	451217	0.29
131-G2V1C04	611	<b>20</b>	120	Yes	450791	0.2825	<b>134-G2F1C04</b>	612	<b>50</b>	50	Yes	451224	0.241
131-G2X1C04	611	<b>30</b>	30	Yes	502728	0.2083	<b>134-G2F1C1C04</b>	612	1	30	Yes	461445	0.26
131-G2X2X04	611	<b>20</b>	240	Yes	450807	0.1869	<b>134-G2F1C1CR104</b>	612	1	30	Yes	450968	0.2833
131-GRETR001	611	<b>30</b>	30	Yes	449214	0.305	<b>134-G2F1CLK04</b>	612	1	50	Yes	451231	0.361
132-G1F1C04	610	<b>20</b>	240	Yes	450814	0.235	<b>134-G2F2C04</b>	612	<b>50</b>	50	Yes	451286	0.255
132-G1Q1C04	610	<b>32</b>	32	Yes	450821	0.2359	<b>134-G2F2CLK04</b>	612	1	50	Yes	451293	0.373
132-G2C0C04	610	<b>20</b>	240	Yes	450838	0.2804	<b>134-G2F2M04</b>	612	<b>50</b>	50	Yes	451309	0.273
132-G2C1C04	610	<b>20</b>	240	Yes	450845	0.2906	<b>134-G2S0CR104</b>	612	<b>50</b>	50	Yes	451316	0.259
132-G2C1C09	610	<b>10</b>	50	Yes	449177	0.296	<b>134-G2S1C04</b>	612	<b>50</b>	50	Yes	451323	0.25
132-G2C1C0C01	610	<b>5</b>	30	Yes	449160	0.3267	<b>134-G2S1CE504</b>	612	1	50	Yes	451330	0.389
132-G2C1C1C04	610	<b>20</b>	240	Yes	450869	0.3265	<b>134-G2S1CE5LK04</b>	612	1	50	Yes	451347	0.45
132-G2C1CLH04	610	<b>20</b>	240	Yes	450906	0.3579	<b>134-G2S1CLK04</b>	612	<b>50</b>	50	Yes	451354	0.311
132-G2C1CN104	610	<b>20</b>	240	Yes	450913	0.266	<b>134-G2S1CR104</b>	612	<b>50</b>	50	Yes	451361	0.254
132-G2C2M01	610	<b>30</b>	30	Yes	449146	0.33	<b>134-G2V1C04</b>	612	<b>50</b>	50	Yes	451378	0.27
132-G2F0C01	610	<b>30</b>	30	Yes	449139	0.2667	<b>134-G2V1CR104</b>	612	<b>50</b>	50	Yes	451385	0.289
132-G2F1C04	610	<b>20</b>	240	Yes	437853	0.2744	<b>134-G2X1C04</b>	612	<b>50</b>	50	Yes	451392	0.176
132-G2F1C0C01	610	<b>5</b>	30	Yes	449115	0.3183	<b>200-062</b>	583	25	25	No	500472	0.352
132-G2F1C1C04	610	<b>20</b>	240	Yes	450951	0.3	<b>200-064</b>	583	25	25	No	500489	0.36
132-G2F2C04	610	<b>20</b>	240	Yes	449092	0.2971	<b>200-066</b>	583	25	25	No	500496	0.408
132-G2Q1C04	610	<b>32</b>	32	Yes	700155	0.29	<b>200-082</b>	583	25	25	No	500502	0.4301
132-G2S1C04	610	<b>20</b>	240	Yes	450975	0.2383	<b>200-084</b>	583	25	25	No	500519	0.4801
132-G2S1CE504	610	<b>10</b>	120	Yes	450999	0.365	<b>200-090</b>	150	25	25	No	105004	0.4801
132-G2V1C04	610	<b>20</b>	120	Yes	451002	0.3004	<b>200-092</b>	150	25	25	No	105011	0.438
132-G2X1C04	610	<b>5</b>	30	Yes	449030	0.2	<b>200-122</b>	583	25	25	No	500540	0.532
133-G1F1C04	613	<b>50</b>	50	Yes	451026	0.252	<b>200-12225</b>	584	25	25	No	502896	0.61
133-G2C1C04	613	<b>50</b>	50	Yes	451033	0.294	<b>200-124</b>	583	25	25	No	518965	0.6073
133-G2C1C1CDHR104	613	1	50	Yes	450753	0.657	<b>206-064</b>	583	25	25	No	500397	0.474
133-G2F1C04	613	<b>50</b>	50	Yes	451057	0.291	<b>206-066</b>	583	25	25	No	500588	0.464
133-G2S1C04	613	<b>50</b>	50	Yes	451064	0.313	<b>206-084</b>	583	<b>25</b>	25	No	500595	0.6946
133-G2S1CE504	613	1	50	Yes	449009	0.444	<b>206-096</b>	150	25	25	No	415240	0.3853
133-G2S1CR104	613	<b>50</b>	50	Yes	451071	0.305	<b>207-06325</b>	584	25	25	No	451408	0.344
133-G2V1C04	613	<b>50</b>	50	Yes	451088	0.321	<b>207-08325</b>	584	25	25	No	451415	0.358
133-G2V1CR104	613	<b>50</b>	50	Yes	451095	0.339	<b>207-08425</b>	584	25	25	No	714176	-
133-G2X1C04	613	<b>50</b>	50	Yes	451101	0.229	<b>207-12425</b>	584	25	25	No	451439	0.78
133-GZ2M2FR104	613	<b>50</b>	20	Yes	502735	0.36	<b>210-064</b>	583	25	25	No	500601	0.3841
133-GZ2S2SR104	613	<b>50</b>	50	Yes	451118	0.25	<b>210-066</b>	583	25	25	No	500618	0.372
134-G1F1C04	612	<b>50</b>	50	Yes	448996	0.191	<b>210-084</b>	583	25	25	No	500625	0.4563
134-G2C0C04	612	<b>50</b>	50	Yes	451156	0.237	<b>210-086</b>	583	25	25	No	500632	0.454
134-G2C0CR104	612	<b>50</b>	50	Yes	451163	0.25	<b>210-122</b>	583	25	25	No	500649	0.55
134-G2C1C04	612	<b>50</b>	50	Yes	451170	0.243	<b>210-12225</b>	584	1	25	No	502902	0.606
134-G2C1C0CDHR104	612	1	50	Yes	450852	0.651	<b>210-28625</b>	584	25	25	No	451446	0.416
134-G2C1C1C04	612	1	30	Yes	207135	0.275	<b>210-38625</b>	584	25	25	No	451453	0.472
134-G2C1C1CDH04	612	1	50	Yes	450876	0.604	<b>213-060</b>	584	25	25	No	504838	0.324

Item No	Page No	Min Qty	Case Qty	UPC Bar-Coded	UPC 6-Digit	Weight (lbs.)	Item No	Page No	Min Qty	Case Qty	UPC Bar-Coded	UPC 6-Digit	Weight (lbs.)
213-061	584	25	25	No	509550	0.324	230-171616101	565	<b>25</b>	25	Yes	701305	0.548
213-067	585	25	25	No	500670	0.3378	230-180616101	565	<b>25</b>	25	Yes	701312	0.534
213-068	584	25	25	No	509574	0.3166	230-180616201	565	<b>25</b>	25	Yes	701329	0.5031
213-069	585	25	25	No	509567	0.2911	230-181616101	565	<b>25</b>	25	Yes	701336	0.514
213-090	150	25	25	No	105028	0.3483	230-190616101	565	<b>25</b>	25	Yes	701343	-
213-092	150	25	25	No	105035	0.3483	230-190616201	565	<b>25</b>	25	Yes	701350	0.54
215-064	584	25	25	No	500700	0.3503	230-191616101	565	<b>25</b>	25	Yes	701367	-
215-066	584	25	25	No	500717	0.3503	230-200616101	565	<b>25</b>	25	Yes	451569	0.46
216-084	583	25	25	No	500724	0.428	230-200616201	565	<b>25</b>	25	Yes	701374	0.452
216-086	583	25	25	No	500731	0.448	230-201616101	565	<b>25</b>	25	Yes	701381	-
230-0105101	563	<b>25</b>	25	Yes	448941	0.258	230-210616101	565	<b>25</b>	25	Yes	451576	0.5044
230-0105201	563	<b>25</b>	25	Yes	451460	0.242	230-210616201	565	<b>25</b>	25	Yes	701398	0.474
230-0106101	563	<b>50</b>	50	Yes	706768	0.3	230-220616101	565	<b>10</b>	10	Yes	448835	0.5
230-0106201	563	<b>50</b>	50	Yes	701091	0.309	230-220616201	565	<b>25</b>	25	Yes	701404	0.47
230-0115101	563	<b>25</b>	25	Yes	451477	0.246	230-230616101	565	<b>25</b>	25	Yes	701411	0.438
230-0115201	563	<b>25</b>	25	Yes	207166	0.234	230-230616201	565	<b>25</b>	25	Yes	701428	0.452
230-0206101	563	<b>50</b>	50	Yes	448927	0.318	230-231616101	565	<b>25</b>	25	Yes	701435	-
230-0206201	563	<b>50</b>	50	Yes	451484	0.365	230-240616101	565	<b>25</b>	25	Yes	701442	0.456
230-0226301	563	<b>25</b>	25	Yes	701107	0.512	230-240616201	565	<b>25</b>	25	Yes	701459	0.464
230-0316101	563	<b>50</b>	50	Yes	451491	0.342	230-241616101	565	<b>25</b>	25	Yes	701466	0.462
230-0316201	563	<b>50</b>	50	Yes	207180	0.339	230-250616101	565	<b>25</b>	25	Yes	451590	0.454
230-0406101	563	<b>50</b>	50	Yes	451514	0.413	230-250616201	565	<b>25</b>	25	Yes	701473	0.466
230-0406201	563	<b>50</b>	50	Yes	451521	0.408	230-251616101	565	<b>25</b>	25	Yes	701480	0.472
230-0516150	563	<b>50</b>	50	Yes	701114	0.344	230-2606101	565	<b>20</b>	20	Yes	448828	0.47
230-0706101	563	<b>50</b>	50	Yes	701121	0.355	230-2606201	565	<b>20</b>	20	Yes	725677	0.68
230-0706201	563	<b>50</b>	50	Yes	701138	0.36	230-261616101	565	<b>25</b>	25	Yes	701497	0.52
230-0706401	563	<b>50</b>	50	Yes	701145	0.41	230-270616101	566	<b>25</b>	25	Yes	701503	-
230-0716101	563	<b>50</b>	50	Yes	701152	0.347	230-270616201	566	<b>25</b>	25	Yes	715364	-
230-0716201	563	<b>50</b>	50	Yes	701169	0.35	230-270621101	566	<b>25</b>	25	Yes	701510	-
230-0806101	563	<b>50</b>	50	Yes	701176	0.346	230-270625101	566	<b>25</b>	25	Yes	701527	0.736
230-0806201	563	<b>50</b>	50	Yes	701183	0.348	230-271616101	566	<b>25</b>	25	Yes	701534	0.428
230-0908101	564	<b>12</b>	12	Yes	448903	0.2625	230-271616201	566	<b>25</b>	25	Yes	701541	-
230-0918101	564	<b>12</b>	12	Yes	701190	-	230-271621101	566	<b>25</b>	25	Yes	701558	0.522
230-1005101	564	<b>10</b>	10	Yes	448897	0.59	230-271625101	566	<b>25</b>	25	Yes	701565	0.626
230-1005201	564	<b>10</b>	10	Yes	701206	0.62	230-280616101	566	<b>25</b>	25	Yes	701572	0.432
230-1015101	564	<b>10</b>	10	Yes	701213	0.505	230-280616201	566	<b>25</b>	25	Yes	701589	0.414
230-106101	564	<b>10</b>	10	Yes	203854	0.76	230-281616101	566	<b>25</b>	25	Yes	701596	0.438
230-1106101	564	<b>10</b>	10	Yes	448880	0.64	230-2906101	566	<b>10</b>	10	Yes	448811	0.505
230-1106201	564	<b>10</b>	10	Yes	701220	0.78	230-290616201	566	<b>25</b>	25	Yes	451675	0.444
230-1106301	564	<b>10</b>	10	Yes	701237	0.82	230-291616101	566	<b>25</b>	25	Yes	701602	0.464
230-1116101	564	<b>10</b>	10	Yes	701244	-	230-300616101	566	<b>25</b>	25	Yes	503435	0.456
230-1505101	564	<b>12</b>	12	Yes	448873	0.1625	230-300616201	566	<b>25</b>	25	Yes	701619	0.436
230-1506101	564	<b>25</b>	25	Yes	448866	0.188	230-300621101	566	<b>25</b>	25	Yes	701626	0.48
230-1516101	564	<b>25</b>	25	Yes	701251	0.194	230-300625101	566	<b>25</b>	25	Yes	701633	0.536
230-1606101	564	<b>12</b>	12	Yes	448859	0.2292	230-301616101	566	<b>25</b>	25	Yes	701640	0.446
230-1616101	564	<b>12</b>	12	Yes	701268	0.2167	230-301621101	566	<b>25</b>	25	Yes	701657	0.484
230-170507101	564	<b>25</b>	25	Yes	701275	0.134	230-301625101	566	<b>25</b>	25	Yes	701664	-
230-170607101	564	<b>25</b>	25	Yes	448842	0.14	230-310616101	566	<b>25</b>	25	Yes	701671	0.448
230-170616101	565	<b>25</b>	25	Yes	701282	0.538	230-310616201	566	<b>25</b>	25	Yes	701688	0.482
230-170616201	565	<b>25</b>	25	Yes	701299	-	230-311616101	566	<b>25</b>	25	Yes	701695	0.452

Supply

Drainage

Support

Specialties

Appendix

# Numerical Index

Supply

Drainage

Support

Specialties

Appendix

Item No	Page No	Min Qty	Case Qty	UPC Bar-Coded	UPC 6-Digit	Weight (lbs.)	Item No	Page No	Min Qty	Case Qty	UPC Bar-Coded	UPC 6-Digit	Weight (lbs.)
230-320616101	566	<b>25</b>	25	Yes	501226	0.488	230-48061625	568	<b>25</b>	25	Yes	502940	0.338
230-320616201	566	<b>25</b>	25	Yes	701701	0.516	230-530608225	569	<b>25</b>	25	Yes	701886	0.154
230-321616101	566	<b>25</b>	25	Yes	207241	0.506	230-53060825	569	<b>25</b>	25	Yes	203823	0.152
230-330616101	567	<b>25</b>	25	Yes	451750	0.412	230-53160825	569	<b>25</b>	25	Yes	701893	0.152
230-330616201	567	<b>25</b>	25	Yes	711786	0.412	230-54060825	569	<b>25</b>	25	Yes	503442	0.162
230-331616101	567	<b>25</b>	25	Yes	451767	0.452	230-54160825	569	<b>25</b>	25	Yes	701909	-
230-40060125	567	<b>25</b>	25	Yes	451774	0.03	230-550608225	569	<b>25</b>	25	Yes	715371	0.154
230-40060450	567	<b>50</b>	50	Yes	451781	0.049	230-55060825	569	<b>25</b>	25	Yes	452085	0.158
230-40060650	567	<b>50</b>	50	Yes	451798	0.075	230-55160825	569	<b>25</b>	25	Yes	452092	0.242
230-40060825	567	<b>25</b>	25	Yes	451804	0.108	230-56060825	569	<b>25</b>	25	Yes	452108	0.154
230-40061225	567	<b>25</b>	25	Yes	451811	0.152	230-56160825	569	<b>25</b>	25	Yes	701916	0.17
230-40160450	567	<b>50</b>	50	Yes	207258	-	230-57060825	568	<b>25</b>	25	Yes	701923	0.196
230-40160650	567	<b>50</b>	50	Yes	451828	0.083	230-58060825	568	<b>25</b>	25	Yes	701930	0.194
230-40160825	567	<b>25</b>	25	Yes	451835	0.108	230-600607101	569	<b>25</b>	25	Yes	448705	0.175
230-40161225	567	<b>25</b>	25	Yes	451842	0.17	230-600609125	569	<b>25</b>	25	Yes	701947	0.188
230-41061625	567	<b>25</b>	25	Yes	451859	0.226	230-600611125	569	<b>25</b>	25	Yes	452115	0.192
230-41161625	567	<b>25</b>	25	Yes	451866	0.21	230-600615125	569	<b>25</b>	25	Yes	452122	0.236
230-44061625	567	<b>25</b>	25	Yes	701718	0.64	230-600624125	569	<b>25</b>	25	Yes	452139	0.562
230-450506132	568	<b>32</b>	32	Yes	451873	0.1031	230-60160725	569	<b>25</b>	25	Yes	207272	0.17
230-450506232	568	<b>32</b>	32	Yes	701725	0.1031	230-60160925	569	<b>25</b>	25	Yes	701954	0.19
230-450508125	568	<b>25</b>	25	Yes	701732	0.124	230-601611125	569	<b>25</b>	25	Yes	452146	0.198
230-450508225	568	<b>25</b>	25	Yes	701749	0.12	230-601615125	569	<b>25</b>	25	Yes	452153	0.24
230-450512116	568	<b>16</b>	16	Yes	451880	0.1688	230-61060725	569	<b>25</b>	25	Yes	701961	0.174
230-450512216	568	<b>16</b>	16	Yes	701756	0.1812	230-61060925	569	<b>25</b>	25	Yes	452160	0.18
230-450606132	568	<b>32</b>	32	Yes	451897	0.122	230-61061225	569	<b>25</b>	25	Yes	207289	0.196
230-450606232	568	<b>32</b>	32	Yes	701763	0.1328	230-61061525	569	<b>25</b>	25	Yes	452177	0.264
230-450608116	568	<b>16</b>	16	Yes	451903	0.1531	230-61160725	569	<b>25</b>	25	Yes	701978	0.172
230-450608216	568	<b>16</b>	16	Yes	701770	0.1812	230-61160925	569	<b>25</b>	25	Yes	701985	0.184
230-450612116	568	<b>16</b>	16	Yes	451910	0.2281	230-611611125	569	<b>25</b>	25	Yes	701992	0.1924
230-450612216	568	<b>16</b>	16	Yes	701787	0.2281	230-61161525	569	<b>25</b>	25	Yes	452184	0.274
230-451506132	568	<b>32</b>	32	Yes	701794	0.1031	230-8006125	570	<b>25</b>	25	Yes	452191	0.132
230-451606132	568	<b>32</b>	32	Yes	451927	0.1297	230-8016125	570	<b>25</b>	25	Yes	702005	0.118
230-451608116	568	<b>16</b>	16	Yes	451934	0.1438	230-8206125	570	<b>25</b>	25	Yes	452207	0.106
230-451608216	568	<b>16</b>	16	Yes	701800	0.1812	230-8216125	570	<b>25</b>	25	Yes	452214	0.129
230-451612116	568	<b>16</b>	16	Yes	451941	0.1969	230-8406101	570	<b>25</b>	25	Yes	448668	0.128
230-460516125	568	<b>25</b>	25	Yes	451958	0.214	230-8506101	570	<b>25</b>	25	Yes	448651	0.1917
230-460516225	568	<b>25</b>	25	Yes	701817	0.236	230-8516101	570	<b>25</b>	25	Yes	702012	-
230-460616125	568	<b>25</b>	25	Yes	451965	0.282	230-860625	570	<b>25</b>	25	Yes	702029	-
230-460616225	568	<b>25</b>	25	Yes	701824	0.29	230-861625	570	<b>25</b>	25	Yes	702036	-
230-461516125	568	<b>25</b>	25	Yes	701831	0.238	230-8706125	570	<b>25</b>	25	Yes	448644	0.176
230-461616125	568	<b>25</b>	25	Yes	451972	0.268	230-8716125	570	<b>25</b>	25	Yes	702043	0.178
230-461616225	568	<b>25</b>	25	Yes	701848	0.29	230-8806125	570	<b>25</b>	25	Yes	702050	0.178
230-47050650	568	<b>50</b>	50	Yes	451989	0.074	230-8816125	570	<b>25</b>	25	Yes	702067	-
230-47050825	568	<b>25</b>	25	Yes	451996	0.14	230-9006101	570	<b>25</b>	25	Yes	448637	0.386
230-47051225	568	<b>25</b>	25	Yes	452009	0.194	230-9506101	570	<b>25</b>	25	Yes	448620	0.086
230-47060825	568	<b>25</b>	25	Yes	452016	0.1625	230-9506GT	471	<b>25</b>	25	No	714862	0.096
230-47061225	568	<b>25</b>	25	Yes	452023	0.2652	230-9506GT	570	<b>25</b>	25	No	714862	0.096
230-47150850	568	<b>50</b>	50	Yes	701855	0.094	230-9506SGT	570	<b>25</b>	25	No	715487	-
230-47160625	568	<b>25</b>	25	Yes	701862	0.248	230-9516101	570	<b>25</b>	25	Yes	702074	0.088
230-47161225	568	<b>25</b>	25	Yes	701879	-	231-1506101	571	<b>25</b>	25	Yes	448613	0.252

Item No	Page No	Min Qty	Case Qty	UPC Bar-Coded	UPC 6-Digit	Weight (lbs.)	Item No	Page No	Min Qty	Case Qty	UPC Bar-Coded	UPC 6-Digit	Weight (lbs.)
231-4006101	571	<b>15</b>	15	Yes	448606	0.1533	240-0464C04	575	1	25	Yes	452597	1.856
231-4505101	571	<b>15</b>	15	Yes	448590	0.1033	240-0467C04	575	1	25	Yes	452580	1.896
231-4506101	571	<b>15</b>	15	Yes	448583	0.1433	240-0487C04	575	1	25	Yes	452603	1.752
231-4606101	571	<b>25</b>	25	Yes	448576	0.142	240-0553C04	576	1	25	Yes	207371	-
234-QP	473	<b>25</b>	100	No	300003	0.035	240-05541C04	576	1	25	Yes	452610	1.512
234-QP	572	<b>25</b>	100	No	300003	0.035	240-0554C04	576	1	25	Yes	452627	1.502
234-QP2	473	<b>25</b>	100	No	321572	0.0175	240-0563C04	576	1	25	Yes	207388	-
234-QP2	572	<b>25</b>	100	No	321572	0.0175	240-0564C04	576	1	25	Yes	452634	1.844
239	626	<b>50</b>	50	No	518996	0.08	240-05B531C04	576	1	25	Yes	706591	-
239PK2	626	<b>10</b>	10	Yes	302007	0.1254	240-05B631C04	576	1	25	Yes	706607	-
240-0151C04	575	1	25	Yes	452245	0.652	240-06631C04	575	1	25	Yes	452641	1.3
240-015212C04	575	1	25	Yes	452252	1.04	240-08648R104	576	1	5	Yes	452658	1.85
240-0152C04	575	1	25	Yes	452276	0.866	240-08688R104	576	1	5	Yes	452665	0.35
240-015312C04	575	1	25	Yes	452283	1.266	240-08848C04	576	1	5	Yes	452672	1.56
240-01531C04	575	1	25	Yes	706546	-	240-08948R104	576	1	5	Yes	452696	3.4
240-01539C04	575	1	25	Yes	706553	-	240-09648R104	577	1	5	Yes	452733	1.79
240-0153C04	575	1	25	Yes	452306	1.038	240-09847C04	577	1	5	Yes	452740	1.5
240-0161C04	575	1	25	Yes	452313	0.944	240-09847R104	577	1	5	Yes	452726	1.98
240-0161R104	575	1	25	Yes	448545	0.83	240-09848C04	577	1	5	Yes	452757	1.62
240-016215C04	575	1	25	Yes	207302	-	240-09947C04	577	1	5	Yes	706829	1.68
240-01621C04	575	1	25	Yes	462091	1.17	240-09947R104	577	1	5	Yes	452764	2.1
240-0162C04	575	1	25	Yes	452320	1.046	240-09988R104	577	1	5	Yes	452771	3.48
240-0162R104	575	1	25	Yes	452337	0.986	240-1052C04	578	1	25	Yes	452702	0.758
240-0163121C04	575	1	25	Yes	452344	1.608	240-1062C04	578	1	25	Yes	452719	0.9
240-016312C04	575	1	25	Yes	452351	1.51	240-1151C04	578	1	12	Yes	452795	1.1375
240-01631C04	575	1	25	Yes	452368	1.312	240-1152C04	578	1	12	Yes	452801	1.45
240-01639C04	575	1	25	Yes	706560	-	240-1153C04	578	1	12	Yes	452818	1.8375
240-0163C04	575	1	25	Yes	452382	1.286	240-1161C04	578	1	12	Yes	452825	1.5042
240-0163R104	575	1	25	Yes	452399	1.24	240-1162C04	578	1	12	Yes	452832	1.9167
240-01831C04	575	1	25	Yes	452412	1.234	240-1163C04	578	1	12	Yes	452849	2.125
240-0252C04	576	1	25	Yes	452436	0.89	240-12531C04	578	1	12	Yes	452856	1.8625
240-025315C04	576	1	25	Yes	207319	1.496	240-12631C04	578	1	12	Yes	452863	2.2292
240-02531C04	576	1	25	Yes	452443	1.092	240-1352C04	578	1	12	Yes	706614	-
240-0253C04	576	1	25	Yes	452450	1.098	240-13531C04	578	1	12	Yes	452870	1.95
240-0261C04	576	1	25	Yes	452467	0.942	240-1353C04	578	1	12	Yes	706621	-
240-0262C04	576	1	25	Yes	452474	1.026	240-1362C04	578	1	12	Yes	706638	-
240-026312C04	576	1	25	Yes	502957	-	240-13631C04	578	1	12	Yes	452887	2.2958
240-02631C04	576	1	25	Yes	452481	1.302	240-1453C04	578	1	12	Yes	452894	1.875
240-0263C04	576	1	25	Yes	452498	1.294	240-1463C04	578	1	12	Yes	452900	2.3
240-03531C04	576	1	25	Yes	706577	-	240-1551C12	579	1	12	Yes	452917	0.4458
240-0353C04	576	1	25	Yes	452504	1.13	240-1552C04	579	1	25	Yes	452924	0.484
240-03631C04	576	1	25	Yes	706584	-	240-1553C04	579	1	25	Yes	452931	0.564
240-0363C04	576	1	25	Yes	452511	1.402	240-1561C01	579	1	12	Yes	448514	0.5458
240-0452C04	575	1	25	Yes	462107	-	240-1562C04	579	1	25	Yes	452948	0.576
240-0453C04	575	1	25	Yes	452528	1.086	240-1563C04	579	1	25	Yes	502889	-
240-0454C04	575	1	25	Yes	452542	1.494	240-1661C04	579	1	25	Yes	706430	0.61
240-04571C04	575	1	25	Yes	452535	1.498	240-1662C04	579	1	25	Yes	452979	0.472
240-0462C04	575	1	25	Yes	452559	1.062	240-1663C04	579	1	25	Yes	452986	0.752
240-04631C04	575	1	25	Yes	452566	1.36	240-175107C24	579	1	24	Yes	207401	0.2167
240-0463C04	575	1	25	Yes	452573	1.288	240-176107C24	579	1	24	Yes	452993	0.2854

Supply

Drainage

Support

Specialties

Appendix

# Numerical Index

Supply

Drainage

Support

Specialties

Appendix

Item No	Page No	Min Qty	Case Qty	UPC Bar-Coded	UPC 6-Digit	Weight (lbs.)	Item No	Page No	Min Qty	Case Qty	UPC Bar-Coded	UPC 6-Digit	Weight (lbs.)
240-176212C24	579	1	24	Yes	453006	0.5333	240-406312C25	581	1	25	Yes	453426	0.644
240-176307C24	579	1	24	Yes	453013	0.4833	240-406312R125	581	1	25	Yes	453433	0.668
240-1861C04	578	1	12	Yes	448491	1.9125	240-416116C25	581	1	25	Yes	453457	0.53
240-19875C04	577	1	25	Yes	207432	-	240-416216C25	581	1	25	Yes	453464	0.636
240-20825C04	577	1	25	Yes	453020	1.72	240-416316C25	581	1	25	Yes	706669	-
240-20835C04	577	1	25	Yes	453037	1.888	240-455106C32	582	1	32	Yes	453471	0.2109
240-2163C04	579	1	25	Yes	453044	0.584	240-455108C16	582	1	16	Yes	453488	0.2562
240-2267C04	577	1	25	Yes	453051	1.184	240-455112C16	582	1	16	Yes	453495	0.3667
240-22836C04	577	1	25	Yes	453068	1.124	240-455112R116	582	1	16	Yes	453501	0.4656
240-2287C04	577	1	25	Yes	453075	1.192	240-455206C32	582	1	32	Yes	453518	0.2781
240-276116C04	579	1	25	Yes	453082	1.704	240-455208C16	582	1	16	Yes	453525	0.3625
240-276121C04	579	1	25	Yes	453099	2.092	240-455212C16	582	1	16	Yes	453532	0.5219
240-276216C04	579	1	25	Yes	453105	1.934	240-455306C32	582	1	32	Yes	453549	0.3344
240-276221C04	579	1	25	Yes	207500	-	240-455308C16	582	1	16	Yes	453556	0.4719
240-276316C04	579	1	25	Yes	453112	2.024	240-455312C16	582	1	16	Yes	453563	0.6344
240-276321C04	579	1	25	Yes	207517	2.434	240-456106C32	582	1	32	Yes	453570	0.2656
240-286116C04	580	1	25	Yes	453129	1.684	240-456108C16	582	1	16	Yes	453587	0.3594
240-286216C04	580	1	25	Yes	453136	1.806	240-4561106C32	582	1	32	Yes	706676	-
240-2863161C04	580	1	25	Yes	453143	1.754	240-4561112C16	582	1	16	Yes	706683	-
240-306116C04	580	1	25	Yes	453150	1.672	240-456112C16	582	1	16	Yes	453594	0.475
240-306121C04	580	1	25	Yes	453167	1.984	240-456112R106	582	1	16	Yes	448392	0.4906
240-3062161C04	580	1	25	Yes	207524	2.258	240-456206C16	582	1	16	Yes	706690	-
240-306216C04	580	1	25	Yes	453174	1.746	240-456208C16	582	1	16	Yes	453600	0.4219
240-3063161C04	580	1	25	Yes	453181	2.114	240-456212C16	582	1	16	Yes	453617	0.5656
240-316116C04	580	1	25	Yes	453198	1.336	240-456306C32	582	1	32	Yes	453624	0.4297
240-316216C04	580	1	25	Yes	453204	1.53	240-456308C16	582	1	16	Yes	453631	0.5125
240-316316C04	580	1	25	Yes	706645	-	240-4563121C16	582	1	16	Yes	453648	0.7469
240-336213C04	580	1	25	Yes	453211	2.014	240-4563121R116	582	1	16	Yes	453655	0.7281
240-336313C04	580	1	25	Yes	706652	2.114	240-456312C16	582	1	16	Yes	453662	0.7531
240-405104C50	580	1	50	Yes	453228	0.143	240-465115C16	582	1	16	Yes	453679	0.6906
240-405106C50	580	1	50	Yes	453235	0.182	240-466116C16	582	1	16	Yes	453686	0.7188
240-405108C25	580	1	25	Yes	453242	0.196	240-466216C16	582	1	16	Yes	706706	0.7188
240-405112C25	580	1	25	Yes	453259	0.358	240-475106C50	582	1	50	Yes	462114	0.135
240-406104C50	581	1	50	Yes	453266	0.134	240-475108C25	582	1	25	Yes	207562	-
240-406106C50	581	1	50	Yes	453273	0.198	240-475112C25	582	1	25	Yes	453693	0.272
240-406106R150	581	1	50	Yes	453280	0.199	240-476106C01	582	1	25	Yes	207579	-
240-406108C25	581	1	25	Yes	453297	0.262	240-476108C25	582	1	25	Yes	453709	0.266
240-406112C25	581	1	25	Yes	453310	0.401	240-476112C25	582	1	25	Yes	453716	0.296
240-406112R125	581	1	25	Yes	453327	0.4275	240-476212C25	582	1	25	Yes	502742	0.542
240-406118R125	581	1	25	Yes	207548	-	240-606107C01	585	1	25	Yes	448385	0.342
240-406124R125	581	1	25	Yes	453334	0.926	240-606108R124	585	1	24	Yes	453747	0.3958
240-406204C50	581	1	50	Yes	453341	0.164	240-606111C24	585	1	24	Yes	453754	0.525
240-406206C50	581	1	50	Yes	453358	0.248	240-606111R124	585	1	24	Yes	453761	0.5271
240-406206R150	581	1	50	Yes	207555	-	240-606115C24	585	1	24	Yes	453778	0.6125
240-406208C25	581	1	25	Yes	453365	0.388	240-606118R124	585	1	24	Yes	453785	0.725
240-406212C25	581	1	25	Yes	453372	0.476	240-606124R124	585	1	24	Yes	453792	0.9208
240-406212R125	581	1	25	Yes	453389	0.456	240-606136R124	585	1	24	Yes	453730	1.3083
240-406306C50	581	1	50	Yes	453396	0.297	240-606211C24	585	1	24	Yes	453815	0.6188
240-406308C25	581	1	25	Yes	453402	0.438	240-606215C24	585	1	24	Yes	706713	-
240-406308R125	581	1	25	Yes	453419	0.436	240-606224R124	585	1	24	Yes	207609	1.2583



Item No	Page No	Min Qty	Case Qty	UPC Bar-Coded	UPC 6-Digit	Weight (lbs.)	Item No	Page No	Min Qty	Case Qty	UPC Bar-Coded	UPC 6-Digit	Weight (lbs.)
240-6063111C24	585	1	24	Yes	453839	0.8438	240-9051C50	587	1	50	Yes	454317	0.397
240-6063112R124	585	1	24	Yes	453846	0.8312	240-9051R150	587	1	50	Yes	454324	0.433
240-6063181R124	585	1	24	Yes	453853	1.1354	240-9052C50	587	1	50	Yes	454331	0.537
240-6063241C24	585	1	24	Yes	453860	1.4396	240-9061C25	587	1	50	Yes	454348	0.517
240-6063241R124	585	1	24	Yes	453877	1.4583	240-9061R150	587	1	50	Yes	454355	0.538
240-616107C01	585	1	24	Yes	453884	0.2646	240-9062C50	587	1	50	Yes	454362	0.608
240-616111C24	585	1	24	Yes	706720	0.4812	240-90631C50	587	1	50	Yes	454379	0.811
240-616111R124	585	1	24	Yes	453891	0.4958	240-90631R150	587	1	50	Yes	454386	0.815
240-616115C24	585	1	24	Yes	453907	0.5042	240-9394R104	577	1	15	Yes	454393	3.35
240-616115R124	585	1	24	Yes	453914	0.5271	240-98720625	579	1	100	Yes	454416	0.896
240-616124C24	585	1	24	Yes	453921	0.9417	240-996208R116	589	1	50	Yes	454423	0.288
240-616124R124	585	1	24	Yes	453938	0.7875	242-10	625	10	10	Yes	501141	0.5589
240-616215C24	585	1	24	Yes	453945	0.6396	242-20	625	25	100	Yes	501158	0.0709
240-616311C24	585	1	24	Yes	706737	-	242-20102	625	10	10	Yes	501165	0.6129
240-616311R124	585	1	24	Yes	453952	0.6812	242-20116	625	25	25	Yes	501189	0.0787
240-626124R120	585	1	20	Yes	453976	1.0275	242-25	625	10	10	Yes	501196	0.145
240-636312R124	585	1	24	Yes	448378	1.2542	245-12530C04	595	1	50	Yes	454447	0.588
240-636316R116	585	1	16	Yes	453983	1.8031	245-12832C04	594	1	5	Yes	448309	1.2
240-703212C25	586	1	25	Yes	453990	0.506	245-12930C04	594	1	50	Yes	448293	0.584
240-705206C50	586	1	50	Yes	454003	0.221	245-13640C04	594	1	50	Yes	454454	0.382
240-705208C25	586	1	25	Yes	454010	0.32	245-16440C04	593	1	20	Yes	448279	0.737
240-705212C25	586	1	25	Yes	454027	0.462	245-16450C04	593	1	20	Yes	448231	0.85
240-705212R125	586	1	25	Yes	454034	0.446	245-16452C04	593	1	20	Yes	448224	0.995
240-705312C25	586	1	25	Yes	454041	0.514	245-16460C04	594	1	24	Yes	448200	0.852
240-705312R125	586	1	25	Yes	454058	0.5	245-16462C04	594	1	50	Yes	448194	0.824
240-705318C25	586	1	25	Yes	706744	-	245-16470C04	593	1	24	Yes	448170	0.827
240-706206C06	586	1	50	Yes	448347	0.254	245-16520C04	593	1	50	Yes	448149	0.3735
240-706208C25	586	1	25	Yes	454065	0.31	245-16522C04	593	1	50	Yes	448132	1.06
240-706212C25	586	1	25	Yes	454072	0.488	245-16530C04	594	1	24	Yes	448125	0.9229
240-706212R125	586	1	25	Yes	454089	0.462	245-16540C04	593	1	50	Yes	448118	0.813
240-706218R125	586	1	25	Yes	454096	0.682	245-16550C04	594	1	50	Yes	448095	0.846
240-706224R125	586	1	25	Yes	454102	1.076	245-16560C04	594	1	50	Yes	448088	0.854
240-706312C25	586	1	25	Yes	454119	0.626	245-16950B204	595	1	5	Yes	454478	1.21
240-706312R125	586	1	25	Yes	454126	0.62	245-52100C04	595	1	100	Yes	448064	0.471
240-706318R125	586	1	25	Yes	454133	0.924	245-56400C01	595	1	100	Yes	448057	0.43
240-718108C25	586	1	25	Yes	454140	0.342	245-96401C01	595	1	50	Yes	448026	0.14
240-8051C25	587	1	25	Yes	454157	0.218	245-96440C01	595	1	25	Yes	448019	0.16
240-8061C25	587	1	25	Yes	454164	0.248	245-96490C04	595	1	50	Yes	448002	0.111
240-825106C01	587	1	24	Yes	454171	0.2958	245-96520C01	595	1	50	Yes	447999	0.186
240-825108C01	587	1	12	Yes	454188	0.3708	245-96540C01	595	1	50	Yes	454515	0.086
240-825112C01	587	1	12	Yes	454195	0.4292	245-99649C04	595	1	10	Yes	462121	0.08
240-8251C25	587	1	25	Yes	454218	0.272	249	626	25	50	Yes	501202	0.274
240-8261C25	587	1	25	Yes	454249	0.274	249-20135	626	50	50	Yes	501219	0.26
240-8451C25	587	1	25	Yes	454263	0.236	250-11	457	1	4	Yes	501769	0.6041
240-8461C25	587	1	50	Yes	454270	0.296	250-11A	458	1	6	Yes	105110	0.2667
240-8561R112	587	1	12	Yes	454287	0.7625	250-11AC	458	1	8	Yes	501776	1.1475
240-8564C01	587	1	12	Yes	448323	0.7042	250-11P	457	6	6	Yes	105127	0.325
240-8664C12	587	1	12	Yes	454294	0.7375	250-11PC	457	1	8	Yes	501813	1.3131
240-8764C06	587	1	12	Yes	448316	0.8292	250-11TB	458	1	6	Yes	100658	0.5033
240-8864C12	587	1	12	Yes	454300	0.7917	250-11TW	457	1	6	Yes	100641	0.5533

Supply

Drainage

Support

Specialties

Appendix

# Numerical Index

Supply

Drainage

Support

Specialties

Appendix

Item No	Page No	Min Qty	Case Qty	UPC Bar-Coded	UPC 6-Digit	Weight (lbs.)	Item No	Page No	Min Qty	Case Qty	UPC Bar-Coded	UPC 6-Digit	Weight (lbs.)
250-12	457	<b>1</b>	4	Yes	501332	0.6425	283-T24120C00	617	<b>25</b>	100	No	454683	0.1965
250-122AB	458	<b>50</b>	50	Yes	501981	0.2614	283-T25112C00	617	<b>25</b>	100	No	462152	0.108
250-122AC	458	<b>1</b>	8	Yes	501950	1.495	283-T25116C00	617	<b>25</b>	100	No	102614	0.1435
250-122P	457	<b>6</b>	6	Yes	327192	0.3667	283-T25120C00	617	<b>25</b>	100	No	454690	0.2015
250-122PB	457	<b>50</b>	50	Yes	502025	0.3044	285-100	617	<b>100</b>	1000	No	501448	0.0007
250-122PC	457	<b>8</b>	8	Yes	502001	1.7625	285-100	617	<b>100</b>	1000	No	501448	0.0007
250-12A	458	<b>1</b>	6	Yes	105141	0.3083	285-100	617	<b>100</b>	1000	No	501448	0.0007
250-12AC	458	<b>1</b>	8	Yes	501752	1.3812	285-S0412000	617	<b>100</b>	100	No	207654	0.055
250-12P	457	<b>1</b>	6	Yes	105134	0.3667	285-S0413000	617	<b>100</b>	100	No	454713	0.0775
250-12PC	457	<b>1</b>	8	Yes	501844	1.5438	285-S0413600	617	<b>100</b>	100	No	454720	0.086
250-696122A	211	<b>6</b>	6	Yes	502032	0.8817	285-T2411200	617	<b>100</b>	100	No	207661	-
250-696122A	458	<b>6</b>	6	Yes	502032	0.8817	285-T2412000	617	<b>100</b>	100	No	207678	0.0535
250-696122P	211	<b>6</b>	6	Yes	502049	0.8283	289-IMK04	618	<b>5</b>	5	Yes	206510	0.55
250-696122P	457	<b>6</b>	6	Yes	502049	0.8283	290-20180	572	<b>5</b>	25	No	501530	0.035
250-696R122A	211	<b>1</b>	6	Yes	410948	1.0333	290-20180	627	<b>5</b>	25	No	501530	0.035
250-696R122A	458	<b>1</b>	6	Yes	410948	1.0333	290-20185	627	<b>12</b>	12	Yes	501554	0.1182
250-696R122P	211	<b>1</b>	6	Yes	410931	0.9833	290-20200	597	<b>10</b>	50	Yes	501561	0.0209
250-696R122P	457	<b>1</b>	6	Yes	410931	0.9833	290-20320	625	<b>100</b>	1000	No	501646	0.0053
270-525	588	<b>25</b>	100	No	454522	0.325	290-20320PK2	625	<b>12</b>	12	Yes	566157	0.0531
270-6	588	<b>25</b>	25	No	501325	0.38	290-20322	625	<b>100</b>	1000	No	501653	0.002
272-5625	588	<b>25</b>	100	No	454539	0.4115	290-20322PK2	625	<b>12</b>	12	Yes	566164	0.0334
272-6	588	<b>25</b>	25	No	501349	0.384	290-20324	625	<b>100</b>	1000	No	501660	0.004
274-5	589	<b>10</b>	100	No	501356	0.0635	290-20324PK2	625	<b>12</b>	12	Yes	566171	0.0414
274-6	589	<b>10</b>	100	No	501363	0.0698	290-20480	618	<b>50</b>	500	No	501714	0.0165
274-7	589	<b>10</b>	100	No	501370	0.062	290-20514C04	596	<b>25</b>	25	Yes	502995	0.726
280-A266537	39	<b>10</b>	2500	No	567062	0.005	290-20515C04	596	<b>1</b>	25	Yes	454751	1.458
280-A266537	127	<b>10</b>	2500	No	567062	0.005	290-20553C04	596	<b>1</b>	50	Yes	447852	1
280-A266607	39	<b>50</b>	1000	No	567079	0.0017	290-20630C04	596	<b>1</b>	50	Yes	454768	0.3
280-A266607	127	<b>50</b>	1000	No	567079	0.0017	290-206322C04	596	<b>1</b>	50	Yes	454775	0.409
280-A266617	39	<b>50</b>	1000	No	567086	0.0022	290-20632C04	596	<b>1</b>	50	Yes	454782	0.44
280-A266617	127	<b>50</b>	1000	No	567086	0.0022	290-20635C04	596	<b>1</b>	50	Yes	454799	0.2
280-A266627	39	<b>25</b>	25	No	567093	0.0736	290-21100	624	<b>48</b>	48	Yes	501974	0.0542
280-A266627	127	<b>25</b>	25	No	567093	0.0736	290-21104	624	<b>48</b>	48	Yes	501998	0.0435
281-072	618	<b>12</b>	12	Yes	556615	0.4745	290-21110	624	<b>5</b>	250	Yes	502018	0.0844
283-S04112C00	617	<b>25</b>	100	No	454553	0.1075	290-363020C01	596	<b>1</b>	25	Yes	447814	0.186
283-S04112R100	617	<b>25</b>	100	No	454560	0.1065	290-363520C01	596	<b>1</b>	25	Yes	447807	0.196
283-S04116C00	617	<b>25</b>	100	No	462145	0.1515	290-3650501	596	<b>1</b>	50	Yes	454805	0.176
283-S04120C00	617	<b>25</b>	100	No	454577	0.0335	290-630223C04	596	<b>1</b>	50	Yes	447784	0.15
283-S04120R100	617	<b>25</b>	100	No	454584	0.1905	290-634223C04	596	<b>1</b>	25	Yes	447777	1.058
283-S04130C50	617	<b>25</b>	100	No	454591	0.304	291-30380	624	<b>10</b>	10	Yes	502650	0.4
283-S04130R150	617	<b>25</b>	100	No	454607	0.28	291-30500	618	<b>12</b>	240	No	502834	0.0052
283-S04136C50	617	<b>25</b>	100	No	454614	0.296	291-30500	733	<b>12</b>	240	No	502834	0.0052
283-S04136R100	617	<b>25</b>	100	No	454621	0.298	300-12	761	<b>12</b>	12	No	500120	0.4583
283-S05112R150	617	<b>50</b>	50	No	501516	0.111	300-20	761	<b>4</b>	4	No	500205	1.08
283-S05120R150	617	<b>50</b>	50	No	501523	0.1863	300-20B	761	<b>6</b>	6	No	504173	1.1031
283-S06112C50	617	<b>25</b>	100	No	454638	0.1445	301-061	762	<b>5</b>	100	No	500373	0.0396
283-S06112R150	617	<b>25</b>	100	No	454645	0.144	301-062	762	<b>10</b>	10	No	500267	0.376
283-S06120C50	617	<b>25</b>	100	No	454652	0.21	301-065	762	<b>20</b>	20	No	500366	0.17
283-S06120R150	617	<b>25</b>	100	No	454669	0.2095	304-06	763	<b>24</b>	24	Yes	520432	0.0771
283-T24112C00	617	<b>25</b>	100	No	454676	0.1335	304-08	40	<b>12</b>	72	Yes	510150	0.276
							304-08	761	<b>12</b>	72	Yes	510150	0.276

Item No	Page No	Min Qty	Case Qty	UPC Bar-Coded	UPC 6-Digit	Weight (lbs.)	Item No	Page No	Min Qty	Case Qty	UPC Bar-Coded	UPC 6-Digit	Weight (lbs.)
304-1	40	1	50	Yes	500571	0.068	305Q2	127	24	24	Yes	400468	0.0179
304-1	761	1	50	Yes	500571	0.068	305Q2	765	24	24	Yes	400468	0.0179
304-11	40	<b>12</b>	12	Yes	567161	0.6208	305Q23PK1	127	<b>12</b>	12	Yes	411648	0.0333
304-11	761	<b>12</b>	12	Yes	567161	0.6208	305Q23PK1	765	<b>12</b>	12	Yes	411648	0.0333
304-12	40	<b>12</b>	12	Yes	566119	0.3333	305Q3	127	24	24	Yes	400482	0.0292
304-12	761	<b>12</b>	12	Yes	566119	0.3333	305Q3	765	24	24	Yes	400482	0.0292
304-12B	40	<b>12</b>	12	Yes	566102	2.4279	305Q4	127	12	12	Yes	400499	0.0421
304-12B	761	<b>12</b>	12	Yes	566102	2.4279	305Q4	765	12	12	Yes	400499	0.0421
304-20	761	1	24	Yes	566461	0.2333	305Q4PK1	127	<b>5</b>	400	Yes	400499	0.0295
304-30	761	1	10	Yes	556219	0.8366	305Q4PK1	765	<b>5</b>	400	Yes	400499	0.0295
304-32	761	1	20	Yes	556226	0.0222	305Q5	127	5	5	Yes	408006	0.345
305-521PK	763	1	5	Yes	566737	8.9	305Q5	765	5	5	Yes	408006	0.345
305-521PKB	763	1	10	No	566812	0.39	305Q6	127	1	1	Yes	408013	0.365
305-649	758	1	10	Yes	737816	4.738	305Q6	765	1	1	Yes	408013	0.365
305-7023	38	1	10	Yes	711809	3.445	305Q7	127	1	1	Yes	407979	0.438
305-7023	757	1	10	Yes	711809	3.445	305Q7	765	1	1	Yes	407979	0.438
305-7040	38	1	10	Yes	711854	2.8	305-RT	217	1	10	Yes	102829	0.285
305-7040	757	1	10	Yes	711854	2.8	305-RT	765	1	10	Yes	102829	0.285
305-7050	38	1	10	Yes	711793	5.12	305-W23KIT	67	1	5	Yes	204790	4.628
305-7050	757	1	10	Yes	711793	5.12	305-W23KIT	758	1	5	Yes	204790	4.628
305-7095	38	1	5	Yes	711816	6.11	305-W2H	67	1	20	Yes	204806	0.455
305-7095	757	1	5	Yes	711816	6.11	305-W2H	758	1	20	Yes	204806	0.455
305-7110	38	1	8	Yes	711823	3.5938	305-W3H	67	1	20	Yes	204813	0.526
305-7110	757	1	8	Yes	711823	3.5938	305-W3H	758	1	20	Yes	204813	0.526
305-7120	38	1	8	Yes	711830	3.6188	305-W4H	67	1	20	Yes	204820	0.712
305-7120	757	1	8	Yes	711830	3.6188	305-W4H	758	1	20	Yes	204820	0.712
305-7123	38	1	8	Yes	711847	3.8	305-WT	67	1	10	Yes	204837	2.072
305-7123	757	1	8	Yes	711847	3.8	305-WT	758	1	10	Yes	204837	2.072
305-7130	38	1	8	Yes	711861	3.7375	305-X665	14	<b>1</b>	1	Yes	447579	33.6
305-7130	757	1	8	Yes	711861	3.7375	305-X665	758	<b>1</b>	1	Yes	447579	33.6
305-7141	757	1	5	Yes	737823	5.738	306-10	763	<b>10</b>	50	Yes	504340	0.949
305-802	40	1	20	Yes	714947	2.3	307-616	640	1	10	Yes	400321	0.3955
305-802	757	1	20	Yes	714947	2.3	307-616	766	1	10	Yes	400321	0.3955
305-802R	757	1	20	No	738066	2.3	307-625	640	<b>6</b>	6	Yes	400130	0.9083
305-803R	757	1	20	No	738073	2.5	307-625	764	<b>6</b>	6	Yes	400130	0.9083
305-804	40	1	10	Yes	714961	2.8	308-2	766	1	12	Yes	556257	2.5488
305-804	757	1	10	Yes	714961	2.8	310-12	767	<b>10</b>	10	Yes	566126	0.33
305-804R	757	1	10	No	738080	5.59	311-10	765	<b>5</b>	5	Yes	504388	1.97
305-85TX	40	1	12	Yes	501738	0.1808	312-2	767	<b>12</b>	12	Yes	504395	1.1375
305-85TX	757	1	12	Yes	501738	0.1808	313-20	764	<b>12</b>	12	Yes	566379	0.5667
305-92TX	40	1	10	Yes	501905	2.63	314-10	765	<b>12</b>	12	Yes	504418	0.3362
305-92TX	757	1	10	Yes	501905	2.63	314-12	765	<b>12</b>	12	Yes	566324	0.3556
305-995	38	1	200	Yes	711878	0.25	315-1	761	10	100	No	504432	0.015
305-995	757	1	200	Yes	711878	0.25	316-1	763	<b>12</b>	12	Yes	566409	0.2168
305-999	40	1	40	Yes	711885	0.9212	316-2	763	<b>12</b>	12	Yes	566416	0.3469
305-999	757	1	40	Yes	711885	0.9212	318-4	766	<b>5</b>	5	Yes	566430	0.6511
305-A139092	40	1	10	Yes	566874	2.5287	318-9	763	<b>10</b>	10	Yes	566447	0.3638
305-A139092	761	1	10	Yes	566874	2.5287	319-15	767	<b>50</b>	50	No	504463	0.3
305-A139092B	40	1	25	Yes	566089	0.393	319-20	767	<b>50</b>	50	No	504470	0.34
305-A139092B	761	1	25	Yes	566089	0.393	319-31	767	<b>50</b>	50	No	504487	0.3168

Supply

Drainage

Support

Specialties

Appendix

# Numerical Index

Supply

Drainage

Support

Specialties

Appendix

Item No	Page No	Min Qty	Case Qty	UPC Bar-Coded	UPC 6-Digit	Weight (lbs.)	Item No	Page No	Min Qty	Case Qty	UPC Bar-Coded	UPC 6-Digit	Weight (lbs.)
330-260	775	<b>24</b>	24	Yes	504494	1.55	<b>427</b>	631	<b>100</b>	100	No	505316	0.025
332-260	775	<b>24</b>	24	Yes	504500	2.0563	<b>427-PB</b>	631	<b>50</b>	50	Yes	510136	0.0505
335-260	775	<b>100</b>	500	Yes	504517	0.024	<b>440-2W</b>	631	<b>25</b>	25	Yes	556608	0.1189
335-263	775	<b>70</b>	350	Yes	504524	0.0384	<b>442-2B</b>	631	<b>25</b>	25	Yes	506467	0.0094
335-520	775	<b>100</b>	500	Yes	509253	0.028	<b>442-2W</b>	631	<b>25</b>	25	Yes	566584	0.0621
335-523	775	<b>70</b>	350	Yes	504548	0.0428	<b>452-PB</b>	633	<b>50</b>	50	Yes	304247	0.2289
355-05PK2	477	<b>1</b>	10	Yes	504555	0.5298	<b>460-10</b>	632	<b>100</b>	1000	No	505354	0.0118
355-100PK1	477	<b>1</b>	10	Yes	722300	-	<b>460-10J</b>	632	<b>1</b>	1	Yes	519047	2.12
355-15PK1	477	<b>1</b>	10	Yes	518019	0.7865	<b>460-11300</b>	632	<b>10</b>	10	No	315106	0.135
355-30PK1	477	<b>1</b>	10	Yes	518033	0.7513	<b>460-11310</b>	632	<b>10</b>	10	No	315120	0.1349
355-60PK1	477	<b>1</b>	10	Yes	518064	0.7913	<b>460-20</b>	632	<b>100</b>	1000	No	505408	0.0118
356-100PK1	477	<b>1</b>	10	Yes	518606	0.3221	<b>460-20J</b>	632	<b>1</b>	1	Yes	519054	0.0145
356-300PK1	477	<b>1</b>	10	Yes	377357	0.3417	<b>490-10108</b>	636	<b>25</b>	25	Yes	505484	0.126
356-30PK1	477	<b>1</b>	10	Yes	504579	0.3223	<b>490-10110</b>	636	<b>25</b>	25	Yes	505507	0.1224
356-60PK1	477	<b>1</b>	10	Yes	504586	0.3587	<b>490-10112</b>	636	<b>25</b>	25	Yes	505521	0.6314
360-15PK1	477	<b>1</b>	10	Yes	518514	0.3633	<b>490-10115</b>	636	<b>25</b>	25	Yes	505538	0.1468
360-300PK1	477	<b>1</b>	10	No	520302	0.455	<b>490-10117</b>	636	<b>25</b>	25	Yes	202765	0.094
390-50105	762	<b>25</b>	25	Yes	500243	0.0517	<b>490-10120</b>	636	<b>25</b>	25	Yes	505552	0.084
390-50110	767	<b>25</b>	25	Yes	504609	0.0848	<b>490-10121</b>	636	<b>25</b>	25	Yes	505569	0.1264
390-50115	766	<b>24</b>	24	Yes	504616	0.0938	<b>490-10122</b>	636	<b>25</b>	25	Yes	505576	0.0205
390-50128	766	<b>12</b>	12	Yes	504678	0.3194	<b>490-10206</b>	636	<b>25</b>	25	Yes	505637	0.1672
390-50130	764	<b>1</b>	25	Yes	504685	1.1512	<b>490-10211</b>	636	<b>1</b>	50	Yes	505651	0.1298
390-50132	764	<b>12</b>	12	Yes	504692	0.2742	<b>490-10302</b>	636	<b>25</b>	25	Yes	505668	0.0904
390-50133	764	<b>12</b>	12	Yes	504708	0.4203	<b>490-10312</b>	636	<b>25</b>	25	Yes	505705	0.0904
390-50134	764	<b>12</b>	12	Yes	507341	0.3583	<b>490-10320</b>	636	<b>1</b>	50	Yes	505743	0.0382
390-50138	766	<b>12</b>	12	Yes	504739	0.0725	<b>490-10325</b>	634	<b>12</b>	12	Yes	505750	0.303
390-50153	762	<b>10</b>	100	Yes	500687	0.1733	<b>490-10340</b>	636	<b>25</b>	25	Yes	505781	0.106
390-50154	762	<b>10</b>	100	Yes	500694	0.0615	<b>490-10341</b>	636	<b>25</b>	25	Yes	505798	0.022
390-50160	767	<b>1</b>	25	Yes	501608	0.386	<b>490-10451</b>	636	<b>24</b>	24	Yes	505965	0.1812
390-50163	762	<b>10</b>	100	Yes	500656	0.2977	<b>490-10465</b>	633	<b>12</b>	12	Yes	505989	0.4667
390-50164	762	<b>10</b>	100	Yes	500663	0.026	<b>490-10500</b>	633	<b>1</b>	50	Yes	506016	0.2806
390-50185	765	<b>10</b>	10	Yes	504951	0.33	<b>490-10540</b>	632	<b>10</b>	10	No	506047	0.3037
390-50197	763	<b>1</b>	20	Yes	504999	1.8151	<b>490-10541</b>	632	<b>10</b>	10	No	506054	0.1857
390-50198	764	<b>20</b>	20	Yes	505002	0.46	<b>490-10542</b>	632	<b>10</b>	10	No	506061	0.2347
390-50200	768	<b>10</b>	50	No	505026	0.1101	<b>490-10543</b>	632	<b>10</b>	10	No	506078	0.37
402-10	632	<b>24</b>	24	No	566638	0.4877	<b>490-10545</b>	632	<b>10</b>	10	No	506092	0.3215
402-410	632	<b>24</b>	24	Yes	519344	0.6074	<b>490-10546</b>	632	<b>10</b>	10	No	304469	0.4445
402-427	632	<b>24</b>	24	Yes	519405	0.5479	<b>490-10547</b>	632	<b>10</b>	10	No	506115	0.473
402-440	632	<b>24</b>	24	Yes	508935	0.6621	<b>490-10548</b>	632	<b>10</b>	10	No	506122	0.645
410-PB	631	<b>50</b>	50	Yes	519009	0.094	<b>490-10555</b>	633	<b>25</b>	25	Yes	506139	0.314
411-PB	631	<b>50</b>	50	Yes	519061	0.121	<b>490-10560</b>	633	<b>25</b>	25	Yes	506146	0.356
412-PB	631	<b>50</b>	50	Yes	519016	0.103	<b>490-10565</b>	633	<b>25</b>	25	Yes	506153	0.382
414-PB	631	<b>50</b>	50	Yes	519023	0.1445	<b>490-10570</b>	633	<b>25</b>	25	Yes	506160	0.542
415-PB	631	<b>50</b>	50	Yes	505118	0.1425	<b>490-10572</b>	633	<b>25</b>	25	Yes	506177	0.5624
416-PB	631	<b>50</b>	50	Yes	519030	0.1245	<b>490-10575</b>	633	<b>25</b>	25	Yes	506184	0.3517
417	631	<b>100</b>	1000	No	505149	0.0094	<b>490-10585</b>	633	<b>25</b>	25	Yes	506191	0.468
418	631	<b>100</b>	1000	Yes	505156	0.0125	<b>490-10656</b>	633	<b>25</b>	25	Yes	506214	0.078
419	631	<b>100</b>	5000	No	505163	0.0061	<b>490-10661</b>	633	<b>25</b>	25	Yes	506238	0.142
425	631	<b>100</b>	100	No	304100	0.0199	<b>490-10666</b>	633	<b>25</b>	25	Yes	506252	0.154
425-PB	631	<b>50</b>	50	Yes	505262	0.042	<b>490-10673</b>	633	<b>25</b>	25	Yes	506290	0.1

Item No	Page No	Min Qty	Case Qty	UPC Bar-Coded	UPC 6-Digit	Weight (lbs.)	Item No	Page No	Min Qty	Case Qty	UPC Bar-Coded	UPC 6-Digit	Weight (lbs.)
490-10676	633	<b>25</b>	25	Yes	506313	0.062	502-9	495	<b>25</b>	25	No	200198	0.24
490-10700	635	<b>12</b>	12	Yes	506320	0.0792	502-9PK	495	<b>10</b>	10	Yes	204196	0.24
490-1080M2KIT	633	<b>1</b>	5	Yes	457530	1.19	505-24	522	<b>100</b>	100	No	200273	0.047
490-11100	634	<b>25</b>	25	Yes	506337	0.216	505-29	522	<b>100</b>	100	No	265494	0.0307
490-11120	634	<b>15</b>	15	Yes	506351	0.2833	505-34	522	<b>100</b>	100	No	200341	0.0488
490-11140	634	<b>12</b>	12	Yes	506375	0.1681	505-39	522	<b>100</b>	100	No	265500	0.0278
490-11150	633	<b>12</b>	12	Yes	506405	0.6612	505-44	522	<b>50</b>	50	No	266965	0.047
490-11151	633	<b>12</b>	12	Yes	506412	0.3766	505-49	522	<b>50</b>	50	No	200327	0.0339
490-11152	634	<b>25</b>	25	Yes	506429	0.0889	505-5	522	<b>25</b>	100	No	201164	0.0419
490-11157	634	<b>12</b>	12	Yes	506450	0.1481	506-26	496	<b>50</b>	500	No	265692	0.0645
490-11159	634	<b>12</b>	12	Yes	506474	0.3451	506-26C	496	<b>50</b>	500	No	205681	0.062
490-11240	631	<b>25</b>	500	Yes	506566	0.0378	506-26CPK2	496	<b>5</b>	5	Yes	205667	0.324
490-11320	448	<b>1</b>	10	Yes	303462	0.185	506-26P	496	<b>50</b>	500	No	265746	0.0623
490-11320	635	<b>1</b>	10	Yes	303462	0.185	506-26PK2	496	<b>5</b>	5	Yes	205063	0.307
490-11322	449	<b>1</b>	10	Yes	303486	0.76	506-34	496	<b>50</b>	500	No	265708	0.044
490-11322	635	<b>1</b>	10	Yes	303486	0.76	506-34P	496	<b>50</b>	500	No	265753	0.046
500-2	495	<b>100</b>	500	No	200013	0.0143	506-36	496	<b>50</b>	500	No	265715	0.0608
501-0	495	<b>500</b>	500	No	265968	0.018	506-36C	496	<b>50</b>	500	No	265791	0.064
501-1	495	<b>500</b>	500	No	265920	0.0125	506-36CPK2	496	<b>5</b>	5	Yes	205742	0.324
501-2	495	<b>500</b>	500	No	265937	0.0133	506-36P	496	<b>50</b>	500	No	265760	0.065
501-2PK	495	<b>100</b>	100	Yes	204233	0.009	506-36PK2	496	<b>5</b>	5	Yes	205148	0.313
501-2PK2	495	<b>10</b>	10	Yes	204226	0.15	506-38P	496	<b>50</b>	500	No	265777	0.0836
501-2PK3	495	<b>1</b>	10	Yes	204240	0.779	506-46	496	<b>50</b>	500	No	205247	0.0661
501-3	495	<b>500</b>	500	No	265944	0.0152	506-46C	496	<b>50</b>	500	No	265814	0.0662
501-3PK	495	<b>100</b>	100	Yes	204271	0.011	506-46CPK2	496	<b>5</b>	5	Yes	205827	0.336
501-3PK2	495	<b>10</b>	10	Yes	204264	0.16	506-46P	496	<b>50</b>	500	No	265784	0.0658
501-3PK3	495	<b>1</b>	10	Yes	204288	0.995	506-46PK2	496	<b>5</b>	5	Yes	205223	0.307
501-4	495	<b>100</b>	100	No	265951	0.0362	506-56	496	<b>50</b>	500	No	200594	0.0576
501-4PK	495	<b>100</b>	100	Yes	204301	0.0304	508-2B	537	<b>25</b>	25	No	201126	0.073
501-5	495	<b>100</b>	100	No	200082	0.0412	508-2PK	537	<b>25</b>	25	Yes	203519	0.0791
501-5PK	495	<b>100</b>	100	Yes	204318	0.0295	508-3B	537	<b>25</b>	25	No	201133	0.076
501-6	495	<b>100</b>	100	No	200099	0.0556	508-3PK	537	<b>25</b>	25	Yes	203557	0.0671
501-6PK	495	<b>100</b>	100	Yes	204325	0.036	508-4B	537	<b>25</b>	25	No	201157	0.0842
501-7	495	<b>100</b>	100	No	200105	0.0444	508-4PK	537	<b>25</b>	25	Yes	203588	0.082
502-1	495	<b>100</b>	100	No	204004	0.018	510-6PK	506	<b>20</b>	20	Yes	260666	0.2452
502-2	495	<b>100</b>	100	No	265524	0.0188	510-6VPK	506	<b>10</b>	10	Yes	260864	0.3044
502-2PK2	495	<b>10</b>	10	Yes	204028	0.2255	510-7PK	506	<b>20</b>	20	Yes	260673	0.2933
502-3	495	<b>100</b>	100	No	265548	0.0265	510-7VPK	506	<b>10</b>	10	Yes	260871	0.3165
502-3PK2	495	<b>10</b>	10	Yes	204066	0.257	510-8PK	506	<b>20</b>	20	Yes	260697	0.3982
502-4	495	<b>100</b>	100	No	265555	0.044	510-8VPK	506	<b>10</b>	10	Yes	260895	0.3917
502-4PK2	495	<b>10</b>	10	Yes	203922	0.192	510-9PK	506	<b>20</b>	20	Yes	260703	0.4362
502-5	495	<b>50</b>	50	No	265562	0.06	510-9VPK	506	<b>10</b>	10	Yes	260901	0.4838
502-5PK2	495	<b>10</b>	10	Yes	203939	0.26	512-26PK	496	<b>50</b>	50	Yes	215666	0.079
502-6	495	<b>50</b>	50	No	265579	0.0595	512-36PK	496	<b>50</b>	50	Yes	215741	0.082
502-6PK2	495	<b>10</b>	10	Yes	267474	0.24	512-46PK	496	<b>50</b>	50	Yes	215826	0.086
502-7	495	<b>50</b>	50	No	265517	0.096	513-26PK	496	<b>25</b>	25	Yes	215093	0.0638
502-75	495	<b>25</b>	25	No	200174	0.1608	513-36PK	496	<b>25</b>	25	Yes	215178	0.1021
502-7PK	495	<b>50</b>	50	Yes	204165	0.104	514-G02	545	<b>100</b>	100	No	205032	0.0904
502-8	495	<b>25</b>	25	No	265531	0.1832	514-G02Q	545	<b>50</b>	50	No	205490	0.105
502-8PK	495	<b>15</b>	15	Yes	204189	0.178	514-G03	545	<b>100</b>	100	No	205056	0.0992

Supply

Drainage

Support

Specialties

Appendix

# Numerical Index

Supply

Drainage

Support

Specialties

Appendix

Item No	Page No	Min Qty	Case Qty	UPC Bar-Coded	UPC 6-Digit	Weight (lbs.)	Item No	Page No	Min Qty	Case Qty	UPC Bar-Coded	UPC 6-Digit	Weight (lbs.)
514-G03Q	545	50	50	No	205483	0.111	517-G02	547	<b>100</b>	100	Yes	203762	0.1046
514-G04	545	<b>100</b>	100	No	205070	0.0975	517-G03	547	<b>100</b>	100	Yes	203779	0.1145
514-G04Q	545	25	25	No	205476	0.126	517-G04	547	<b>100</b>	100	Yes	203786	0.1548
514-G05	545	<b>100</b>	100	No	205087	0.1102	517-G05	547	<b>100</b>	100	Yes	203830	0.0829
514-G05Q	545	25	25	No	205469	0.138	517-G06	547	<b>50</b>	50	Yes	203847	0.2936
514-G06	545	<b>100</b>	100	No	205094	0.116	517-G07	547	<b>50</b>	50	Yes	203861	0.3506
514-G06Q	545	25	25	No	205513	0.156	517-G08	547	<b>50</b>	50	Yes	203878	0.3891
514-G07	545	<b>100</b>	100	No	205117	0.1325	517-G09	547	<b>25</b>	25	Yes	203885	0.4334
514-G07Q	545	10	10	No	205452	0.165	517-G10	547	<b>25</b>	25	Yes	203908	0.6332
515-10GPK2	546	<b>10</b>	10	Yes	261106	0.925	517-I062PK2	547	<b>25</b>	25	Yes	204363	0.154
515-2CPK2	546	<b>10</b>	10	Yes	261229	0.1573	517-I087PK2	547	<b>25</b>	25	Yes	204370	0.194
515-2GPK2	546	<b>10</b>	10	Yes	261021	0.1613	517-I112PK2	547	<b>20</b>	20	Yes	204394	0.23
515-3CPK2	546	<b>10</b>	10	Yes	261236	0.1593	517-I137PK2	547	<b>20</b>	20	Yes	204493	0.3263
515-3GPK2	546	<b>10</b>	10	Yes	261038	0.1803	517-I162PK2	547	<b>20</b>	20	Yes	204509	0.3571
515-4CPK2	546	<b>10</b>	10	Yes	261243	0.1413	517-I212PK2	547	<b>10</b>	10	Yes	204516	0.5247
515-4GPK2	546	<b>10</b>	10	Yes	261045	0.1983	520-09	216	<b>250</b>	250	No	101167	0.0882
515-5CPK2	546	<b>10</b>	10	Yes	261250	0.2341	520-19	533	<b>50</b>	50	No	206640	0.216
515-5GPK2	546	<b>10</b>	10	Yes	261052	0.2891	520-19C	533	<b>50</b>	50	No	206657	0.216
515-6CPK2	546	<b>10</b>	10	Yes	261267	0.2924	520-19CPK	533	<b>25</b>	25	Yes	209061	0.2239
515-6GPK2	546	<b>10</b>	10	Yes	261069	0.2624	520-19PK	533	<b>50</b>	50	Yes	209023	0.2285
515-7CPK2	546	<b>10</b>	10	Yes	261274	0.4064	520-19T	533	50	50	No	206664	0.204
515-7GPK2	546	<b>10</b>	10	Yes	261076	0.33	520-19TC	533	50	50	No	206671	0.195
515-8GPK2	546	<b>10</b>	10	Yes	261083	0.8826	520-24	533	25	25	No	206688	0.292
515-9GPK2	546	<b>10</b>	10	Yes	261090	0.6371	520-419	533	50	50	No	206701	0.203
516-2CPK2	546	<b>20</b>	20	Yes	263421	0.11	520-419T	533	50	50	No	206725	0.1792
516-2GB	546	100	100	No	201324	0.1	520-419TC	533	50	50	No	206732	0.18
516-2GPK2	546	<b>20</b>	20	Yes	263223	0.1225	520-616	533	<b>50</b>	50	No	200853	0.4
516-3CPK2	546	<b>20</b>	20	Yes	263438	0.1244	520-626	533	<b>50</b>	50	No	201317	0.52
516-3GPK2	546	<b>20</b>	20	Yes	263230	0.135	520-626PK	533	<b>10</b>	10	Yes	201317	0.545
516-4CB	546	100	100	No	201195	0.087	520-E16	520	<b>100</b>	100	No	266736	0.1257
516-4CPK2	546	<b>10</b>	10	Yes	263445	0.1703	520-E24	520	<b>100</b>	100	No	266712	0.2425
516-4GPK2	546	<b>10</b>	10	Yes	263247	0.185	521-110	537	25	25	No	201201	0.7125
516-5CB	546	100	100	No	201256	0.101	521-111	537	50	50	No	267795	0.3084
516-5CPK2	546	<b>10</b>	10	Yes	263452	0.175	521-112	537	50	50	No	267801	0.354
516-5GPK2	546	<b>10</b>	10	Yes	263254	0.215	521-113	537	50	50	No	267818	0.3572
516-6CB	546	100	100	No	201294	0.114	521-118	521	<b>50</b>	50	No	206749	0.354
516-6CPK2	546	<b>10</b>	10	Yes	263469	0.19	521-118R	521	25	25	No	206756	0.3736
516-6GPK2	546	<b>10</b>	10	Yes	263261	0.27	521-126	521	50	50	No	206763	0.4134
516-7CB	546	100	100	No	201416	0.15	521-210	505	<b>25</b>	25	Yes	206770	0.0738
516-7CPK2	546	<b>10</b>	10	Yes	263476	0.23	521-210	506	<b>25</b>	25	Yes	206770	0.0738
516-7GPK2	546	<b>10</b>	10	Yes	263278	0.2985	521-318	521	<b>50</b>	50	No	206787	0.628
517-C02	547	<b>100</b>	100	Yes	203564	0.0878	521-360	521	<b>50</b>	50	No	206794	0.738
517-C03	547	<b>100</b>	100	Yes	203595	0.1005	521-3725B	521	<b>100</b>	100	No	266552	0.2566
517-C04	547	<b>100</b>	100	Yes	203601	0.1356	521-557	545	<b>25</b>	25	No	265982	0.0556
517-C05	547	<b>50</b>	50	Yes	203618	0.1597	521-558	545	<b>25</b>	25	No	206800	0.164
517-C06	547	<b>50</b>	50	Yes	203625	0.168	521-559	545	<b>25</b>	25	No	266163	0.188
517-C07	547	<b>50</b>	50	Yes	203687	0.3177	521-6415	521	<b>25</b>	25	No	206817	0.36
517-C08	547	<b>50</b>	50	Yes	203694	0.3398	521-6416	521	<b>25</b>	25	No	265852	0.3532
517-C09	547	<b>50</b>	50	Yes	203724	0.3841	521-723	537	25	25	Yes	266156	0.3694
517-C10	547	<b>25</b>	25	Yes	203748	0.582	521-723BB	537	25	25	No	201447	0.2227

Item No	Page No	Min Qty	Case Qty	UPC Bar-Coded	UPC 6-Digit	Weight (lbs.)	Item No	Page No	Min Qty	Case Qty	UPC Bar-Coded	UPC 6-Digit	Weight (lbs.)
521-725	537	<b>5</b>	5	No	260888	0.806	523-2MS	538	50	50	No	267184	0.175
521-728	537	<b>5</b>	5	No	260840	0.788	523-2MS2	538	50	50	No	267191	0.24
521-729	537	<b>5</b>	5	No	206947	0.78	523-2MS3	538	50	50	No	267207	0.239
521-730	537	<b>5</b>	5	No	207036	0.77	523-2MS4	538	50	50	No	267214	0.3732
521-810	521	<b>50</b>	50	No	206831	0.388	523-31	495	<b>100</b>	1000	No	201744	0.0283
521-810PK	521	<b>50</b>	50	Yes	220202	0.3972	523-32	495	<b>100</b>	1000	No	201751	0.0294
521-820	521	50	50	No	206848	0.256	523-33	495	<b>50</b>	500	No	201768	0.0406
521-851	520	50	50	No	206855	0.5005	523-34	495	<b>50</b>	500	No	201775	0.051
521-851PK	520	<b>25</b>	25	Yes	207029	0.514	523-3MS2C	539	<b>25</b>	100	No	205353	0.0549
521-852	520	50	50	No	206862	0.6314	523-3MS2G	539	<b>25</b>	100	No	205544	0.0375
522-100B	530	1	10	No	201331	0.2431	523-3MS3C	539	<b>25</b>	100	No	205506	0.0375
522-100BPK2	530	1	10	Yes	266187	0.0482	523-3MS3G	539	<b>25</b>	100	No	205551	0.043
522-101	530	<b>100</b>	100	No	201355	0.0089	523-3MS4C	539	<b>10</b>	50	No	205537	0.1
522-102	530	<b>100</b>	100	No	267603	0.0078	523-3MS4G	539	<b>10</b>	50	No	205568	0.113
522-5500	530	<b>100</b>	100	No	201591	0.0317	523-3MS5C	539	<b>10</b>	50	No	205582	0.115
522-5500	538	<b>100</b>	100	No	201591	0.0317	523-3MS5G	539	<b>10</b>	50	No	205599	0.12
522-5501	530	<b>100</b>	100	No	206923	0.0372	523-3MS6C	539	<b>10</b>	50	No	205605	0.138
522-5501	538	<b>100</b>	100	No	206923	0.0372	523-3MS6G	539	<b>10</b>	10	No	205612	0.165
523-01	530	<b>50</b>	50	No	201614	0.0937	523-3MS7C	539	<b>10</b>	50	No	205629	0.161
523-1	530	<b>50</b>	50	No	201232	0.0601	523-3MS7G	539	<b>10</b>	10	No	205575	0.18
523-1	539	<b>50</b>	50	No	201232	0.0601	523-3MS8G	539	<b>10</b>	10	No	205636	0.23
523-16	529	<b>50</b>	50	No	266460	0.325	523-3MS9G	539	<b>10</b>	10	No	205650	0.285
523-1604	529	<b>50</b>	50	No	266446	0.3289	523-3MSL	538	25	25	No	201621	0.7556
523-1610	529	50	50	No	266477	0.3285	523-3MSS	538	25	25	No	201652	0.45
523-1614	529	50	50	No	266361	0.3538	523-3MSS2	538	25	25	No	201874	0.508
523-1614Q	530	<b>25</b>	25	No	709301	0.314	523-3MSS3	538	25	25	No	201898	0.532
523-1620	529	<b>50</b>	50	No	266354	0.3586	523-5500Q	530	<b>100</b>	100	No	203205	0.0276
523-162001	529	1	1	No	266378	17.637	523-5501Q	530	100	100	No	319906	0.8818
523-1620PK1	529	<b>10</b>	10	Yes	266545	0.4428	523-712W	530	<b>10</b>	50	No	203298	0.038
523-1624	529	<b>50</b>	50	No	266385	0.3819	523-734W	530	<b>10</b>	50	No	203304	0.1113
523-162401	529	1	1	No	266392	17.1	523-DEQ	530	1	25	Yes	202772	0.02
523-1624Q	530	25	25	No	202789	0.4034	523F2424	529	50	50	No	208071	0.6259
523-1630	529	50	50	No	266439	0.3874	523F5500	530	<b>100</b>	100	No	265999	0.049
523-1634	529	50	50	No	266408	0.4119	523F5500	538	<b>100</b>	100	No	265999	0.049
523-1634Q	530	25	25	No	202796	0.376	523-VLK1	529	25	25	Yes	205162	0.552
523-16DEQ	530	<b>25</b>	25	No	709219	0.288	523-VLK2	529	25	25	Yes	205179	0.57
523-1B	539	<b>5</b>	50	No	201638	0.1637	524-10	509	<b>50</b>	50	No	201782	0.6
523-1C	539	<b>5</b>	50	No	200532	0.145	524-100	509	<b>5</b>	5	No	201799	5.588
523-1D	539	<b>5</b>	50	No	200556	0.132	524-1022PK2	509	<b>10</b>	50	Yes	203137	0.616
523-1K52000	529	<b>10</b>	10	No	201645	0.5562	524-10CPK2	509	<b>10</b>	10	Yes	203168	0.3692
523-24	529	<b>50</b>	50	No	201669	0.395	524-10PK	509	50	50	Yes	203038	0.5628
523-2404	529	<b>50</b>	50	No	201676	0.422	524-10PK2	509	<b>10</b>	10	Yes	203021	0.5107
523-2414	529	50	50	No	201683	0.5637	524-50	509	<b>10</b>	10	No	201829	2.4383
523-2420	529	<b>50</b>	50	No	201690	0.48	524-50PK3	509	<b>1</b>	10	Yes	203069	2.505
523-242001	529	1	1	No	201225	23.398	525-02	533	<b>100</b>	1000	No	314741	0.0128
523-2424	529	<b>50</b>	50	No	201713	0.5002	525-02G	533	<b>100</b>	1000	No	324016	0.0156
523-242401	529	1	1	No	201218	24.56	525-03	533	<b>100</b>	1000	No	314758	0.0146
523-2424Q	530	25	25	No	202819	0.6101	525-1612	519	<b>25</b>	25	No	267078	0.4708
523-2434	529	50	50	No	201737	0.523	525-1613	519	<b>25</b>	25	No	300010	0.4738
523-2434Q	530	25	25	No	202826	0.5637	525-1614	519	<b>25</b>	25	No	267610	0.478

Supply

Drainage

Support

Specialties

Appendix

# Numerical Index

Supply

Drainage

Support

Specialties

Appendix

Item No	Page No	Min Qty	Case Qty	UPC Bar-Coded	UPC 6-Digit	Weight (lbs.)	Item No	Page No	Min Qty	Case Qty	UPC Bar-Coded	UPC 6-Digit	Weight (lbs.)
525-161PB	519	<b>25</b>	25	Yes	267313	0.52	528-10	509	<b>50</b>	50	No	201836	0.3398
525-161PBL	519	<b>25</b>	25	No	267924	0.5704	528-100	509	<b>5</b>	5	No	201843	3.326
525-161PBPBK	519	10	10	Yes	200877	0.5728	528-10PK	509	<b>50</b>	50	Yes	203090	0.304
525-1622	519	<b>25</b>	25	No	267085	0.5372	528-10PK2	509	<b>10</b>	10	Yes	203083	0.34
525-1622L	519	<b>25</b>	25	No	202314	0.5626	528-25PK2	509	<b>1</b>	12	Yes	266972	0.8312
525-1622PK1	519	10	10	Yes	266651	0.5293	528-50	509	<b>10</b>	10	No	201867	1.7053
525-1622V	520	25	25	No	200501	0.664	530-163	551	<b>100</b>	100	No	265821	0.074
525-1623	519	<b>25</b>	25	No	267092	0.5372	530-1635	551	<b>100</b>	100	No	201881	0.2661
525-1624	519	<b>25</b>	25	No	267627	0.53	530-163PK	551	<b>100</b>	100	Yes	265821	0.0675
525-162PB	519	<b>25</b>	25	Yes	267320	0.68	530-166	551	<b>100</b>	100	No	201904	0.152
525-162PBL	519	<b>25</b>	25	No	267917	0.7264	530-166PK	551	<b>100</b>	100	Yes	201003	0.152
525-162PBPBK	519	10	10	Yes	200884	0.735	530-166PK3	551	<b>1</b>	1	Yes	202505	14.25
525-162PBV	520	25	25	No	200518	0.831	530-169	551	<b>50</b>	50	No	207746	0.204
525-16T	519	<b>100</b>	100	No	267139	0.1925	530-6M	551	<b>100</b>	100	No	266149	0.1531
525-16WLB	520	<b>25</b>	25	No	267696	0.5449	533-1	551	<b>25</b>	25	No	201942	0.578
525-2002PK2	533	50	50	Yes	200846	0.306	533-2	551	<b>25</b>	25	No	201959	0.7682
525-20B	519	<b>100</b>	100	No	267047	0.1966	533-3	551	<b>10</b>	10	No	201966	0.8685
525-20B	534	<b>100</b>	100	No	267047	0.1966	535-14	513	<b>25</b>	25	No	201973	0.798
525-2412	519	<b>25</b>	25	No	267108	0.6067	535-914	513	<b>25</b>	25	No	201997	0.59
525-2413	519	<b>25</b>	25	No	300515	0.6067	535-926	513	<b>25</b>	25	No	202000	0.9659
525-241PB	519	<b>25</b>	25	No	267344	0.6976	535-9P	513	<b>50</b>	50	No	202017	0.0998
525-241PBL	519	<b>25</b>	25	No	267900	0.7275	536-09	552	<b>50</b>	50	No	202024	0.22
525-2422	519	<b>25</b>	25	No	267115	0.6788	536-12	552	<b>50</b>	50	No	202031	0.2974
525-242PB	519	<b>25</b>	25	No	267351	0.837	536-18	552	<b>50</b>	50	No	202048	0.428
525-242PBL	519	<b>25</b>	25	No	267894	1.3988	536-35	551	<b>100</b>	100	No	202055	0.2263
525-24T	519	<b>100</b>	100	No	267146	0.2596	536-36	551	<b>50</b>	50	No	266064	0.352
525-32C	490	<b>1</b>	25	Yes	713162	-	536-56E	551	<b>50</b>	50	No	200006	0.4933
525-33	490	25	25	No	200976	0.2348	536-58	551	<b>50</b>	50	No	202062	0.636
525-33C	490	<b>1</b>	25	Yes	713179	-	536-612	552	<b>25</b>	25	No	266071	1.0523
525-34	490	25	25	No	200983	0.2548	536-616	552	<b>25</b>	25	No	267177	1.652
525-34C	490	<b>1</b>	25	Yes	713186	-	536-68E	551	<b>50</b>	50	No	200037	0.7153
525-35	490	25	25	No	326072	0.2386	536-85	552	<b>50</b>	50	Yes	206275	0.7518
525-35C	490	<b>1</b>	25	No	713193	-	538-09	552	<b>50</b>	50	No	202086	0.194
525-6917	533	<b>100</b>	100	No	713476	0.1985	538-09PK	552	<b>50</b>	50	Yes	206220	0.188
525-6917	534	<b>100</b>	100	No	713476	0.1985	538-12	552	<b>50</b>	50	No	202093	0.252
525-6920	533	<b>100</b>	100	No	713483	0.244	538-18	552	<b>50</b>	50	No	202109	0.348
525-6920	534	<b>100</b>	100	No	713483	0.244	539-18	552	<b>25</b>	25	No	202116	0.997
525-6926	533	<b>100</b>	100	No	713490	0.2495	539-518	552	<b>25</b>	25	No	208088	1.432
525-6926	534	<b>100</b>	100	No	713490	0.2495	539-6	552	<b>50</b>	50	No	202123	0.392
525-B2	519	<b>50</b>	50	No	267153	0.0714	541-CB	545	<b>25</b>	25	No	201805	0.164
525-B2S	519	<b>50</b>	50	Yes	200952	0.1015	541-CPK2	545	<b>20</b>	20	Yes	263636	0.2014
525-B3	519	<b>50</b>	50	No	267160	0.0732	541-GB	545	<b>25</b>	25	No	201850	0.173
525-B3S	519	<b>50</b>	50	Yes	201096	0.101	541-GPK2	545	<b>20</b>	20	Yes	263629	0.2114
525-B4	519	<b>50</b>	50	No	267658	0.077	542-PK2	545	<b>10</b>	10	Yes	264015	0.3973
525-P2	519	<b>50</b>	50	No	267375	0.0613	543-21	542	<b>8</b>	8	No	735256	0.542
525-P22	519	<b>50</b>	50	No	268358	0.1532	543-21R	542	<b>8</b>	8	Yes	729361	0.88
525-P2M	519	<b>100</b>	100	No	268334	0.1379	549-712	506	<b>50</b>	50	No	202185	0.1293
525-P2M1	519	<b>25</b>	25	Yes	268341	0.32	549-734	506	<b>25</b>	25	No	202192	0.1465
525-P2PK	519	<b>10</b>	10	Yes	200891	0.0536	549-810	505	<b>6</b>	6	No	200051	0.7417
525-WLB	520	<b>50</b>	50	No	267702	0.1765	549-811	505	<b>6</b>	6	No	200068	0.7167



Item No	Page No	Min Qty	Case Qty	UPC Bar-Coded	UPC 6-Digit	Weight (lbs.)	Item No	Page No	Min Qty	Case Qty	UPC Bar-Coded	UPC 6-Digit	Weight (lbs.)
550-02	491	<b>1</b>	10	Yes	203335	0.353	551-3C	486	<b>50</b>	500	No	200310	0.0195
550-11	490	<b>100</b>	100	No	202215	0.0335	551-3PK2	486	20	20	Yes	200587	0.2249
550-11E	490	100	100	Yes	266217	0.0925	551-4	486	<b>25</b>	250	No	202475	0.0296
550-11PK2	490	1	10	Yes	200440	0.1577	551-4BKT	486	<b>1</b>	1	No	735249	11.65
550-11Q	490	<b>100</b>	100	No	202239	0.0379	551-4C	486	<b>25</b>	250	No	202499	0.0333
550-11QPK2	490	1	10	Yes	266194	0.3521	551-4PK2	486	20	20	Yes	496775	0.3462
550-12	490	<b>1</b>	1	No	202246	2.9321	551-P2	487	<b>100</b>	1000	No	265296	0.0172
550-210	540	<b>25</b>	250	No	205858	0.0344	551-P2PK3	487	1	10	Yes	200563	1.7452
550-2111	491	<b>50</b>	50	Yes	205841	0.097	551-P2Q	487	<b>100</b>	100	No	205940	0.022
550-2111	539	<b>50</b>	50	Yes	205841	0.097	551-P2S	487	<b>300</b>	300	No	265449	0.0168
550-2111PK3	491	<b>1</b>	1	No	205919	4.6	551-P3	487	<b>50</b>	500	No	265302	0.0228
550-2111PK3	539	<b>1</b>	1	No	205919	4.6	551-P3PK3	487	1	10	Yes	200600	1.1886
550-2111Q	541	5	50	Yes	205834	0.125	551-P3Q	487	<b>100</b>	100	No	205957	0.03
550-2112	491	<b>5</b>	25	Yes	205926	0.136	551-P3S	487	<b>300</b>	300	No	200624	0.0222
550-2112	539	<b>5</b>	25	Yes	205926	0.136	551-P4Q	487	<b>25</b>	25	No	205964	0.038
550-2112Q	541	<b>5</b>	25	Yes	205865	0.194	551-P5Q	487	<b>25</b>	25	No	205988	0.042
550-2113	539	<b>25</b>	25	Yes	205933	0.186	552-A2	487	<b>50</b>	50	No	267382	0.0234
550-2121	540	<b>50</b>	50	Yes	206305	0.118	552-A3	487	<b>50</b>	50	No	267399	0.0273
550-2121PK3	540	<b>1</b>	1	No	206480	5.55	552-B22	487	<b>50</b>	50	No	267405	0.0332
550-2121Q	541	1	25	Yes	206312	0.162	552-B23	487	<b>50</b>	50	No	267412	0.0344
550-2122	540	<b>1</b>	25	Yes	206329	0.158	552-B33	487	<b>50</b>	50	No	267429	0.0345
550-2122Q	541	<b>1</b>	25	Yes	206336	0.212	552-C22	487	<b>50</b>	50	No	267436	0.0319
550-214QPK2	541	<b>1</b>	10	Yes	206503	0.18	552-C23	487	<b>50</b>	50	No	267443	0.0332
550-214QPK3	541	<b>1</b>	4	Yes	206497	0.6125	552-C33	487	<b>50</b>	50	No	267450	0.032
550-3131	540	50	50	Yes	724632	0.094	553-014	505	<b>100</b>	100	No	202987	0.2045
550-3131PK3	540	<b>1</b>	1	Yes	724649	-	553-014PK	505	25	25	Yes	202987	0.178
550-3132	540	<b>25</b>	25	Yes	724656	-	553-026	505	<b>50</b>	50	No	204561	0.3221
550-AMB	541	10	10	Yes	205377	0.5732	553-22W	491	<b>50</b>	150	No	252005	0.0575
550F11	490	<b>25</b>	100	Yes	200419	0.047	553-23W	491	<b>50</b>	150	No	252012	0.0645
550F3111	540	25	25	Yes	724670	-	553-2W	491	<b>50</b>	50	Yes	252043	0.0341
550F3121	540	<b>10</b>	10	Yes	724687	0.165	553-3W	491	<b>50</b>	50	Yes	252081	0.0354
550F3121PK3	540	<b>1</b>	1	Yes	724700	-	553-4W	491	<b>50</b>	50	Yes	252128	0.0389
550F3131	540	<b>10</b>	10	Yes	724694	-	553-5W	491	<b>50</b>	50	Yes	252449	0.0461
550F3131PK3	540	<b>1</b>	1	Yes	724717	-	553-6W	505	<b>50</b>	50	Yes	252166	0.0844
550-FP2	525	<b>25</b>	25	No	266996	0.28	553-6WM25	505	<b>10</b>	10	Yes	207753	2.155
550-FP2S	525	<b>25</b>	25	No	267597	0.1962	553-6WZ	505	<b>25</b>	100	No	205872	0.108
550-M2	525	<b>50</b>	50	No	202352	0.1013	553-6WZPK2	505	4	5	Yes	267825	0.51
550-M3	525	<b>25</b>	25	No	202369	0.23	553-7W	505	<b>50</b>	50	Yes	252203	0.1028
550-MP2	525	<b>25</b>	25	No	202383	0.2048	553-7WZ	505	<b>25</b>	100	No	205889	0.1115
550-MP2PK	525	<b>10</b>	10	Yes	208545	0.2299	553-7WZPK2	505	4	5	Yes	267832	0.52
550-MP3	525	<b>25</b>	25	No	266538	0.322	553-830W	505	<b>50</b>	50	Yes	252852	0.1447
550-PB2	525	<b>50</b>	50	No	203175	0.0544	553-8W	505	<b>50</b>	50	Yes	252241	0.1082
550-PB3	525	<b>50</b>	50	No	205346	0.165	553-8WM25	505	<b>10</b>	10	Yes	207777	2.515
550-PC2	525	<b>10</b>	10	No	205131	0.333	553-8WZ	505	<b>25</b>	100	No	205896	0.1365
551-2	486	<b>100</b>	1000	No	202390	0.0131	553-8WZPK2	505	4	5	Yes	267849	0.61
551-2BKT	486	<b>1</b>	1	No	735300	17.45	553-9W	505	<b>25</b>	25	Yes	252289	0.1652
551-2C	486	<b>100</b>	1000	No	202413	0.0132	553-9WZ	505	<b>25</b>	100	No	205902	0.153
551-2PK2	486	<b>20</b>	20	Yes	200549	0.1542	553-9WZPK2	505	4	5	Yes	267856	0.67
551-3	486	<b>50</b>	500	No	265289	0.0206	553-STRP	505	<b>50</b>	50	No	204554	0.074
551-3BKT	486	<b>1</b>	1	No	735317	13.55	554-08	500	<b>100</b>	2500	No	202802	0.0028

Supply

Drainage

Support

Specialties

Appendix

# Numerical Index

Supply

Drainage

Support

Specialties

Appendix

Item No	Page No	Min Qty	Case Qty	UPC Bar-Coded	UPC 6-Digit	Weight (lbs.)	Item No	Page No	Min Qty	Case Qty	UPC Bar-Coded	UPC 6-Digit	Weight (lbs.)
554-100	509	1	20	Yes	203281	1.2054	557-5PK2	488	10	10	Yes	200167	0.1495
554-100W	509	1	20	Yes	266514	0.9125	557-5Q	488	<b>25</b>	25	No	318961	0.0587
554-10PK2	509	<b>10</b>	10	Yes	203229	0.16	557-6	488	<b>25</b>	250	No	203236	0.0307
554-14	500	<b>100</b>	1000	No	265456	0.0053	557-6PK2	488	10	10	Yes	200181	0.2035
554-14H	500	<b>100</b>	1000	No	200075	0.0126	557-7	488	<b>25</b>	250	No	202901	0.0428
554-21	500	<b>50</b>	500	No	202833	0.0286	557F2	489	<b>100</b>	1000	No	203250	0.0163
554-25	509	<b>1</b>	20	Yes	203243	0.3625	557F3	489	<b>50</b>	500	No	203267	0.0212
554-25W	509	<b>1</b>	20	Yes	266521	0.24	557F4	489	<b>50</b>	500	No	203274	0.0291
554-36	500	<b>50</b>	250	No	202857	0.042	557F5	489	<b>10</b>	10	No	200716	0.1083
555-1	485	<b>100</b>	1000	No	265319	0.0071	557F6	489	<b>10</b>	10	No	200723	0.1083
555-2	485	<b>100</b>	1000	No	265326	0.0097	557F7	489	<b>10</b>	10	No	200730	0.085
555-23	486	<b>100</b>	1000	No	265357	0.0155	558-2	489	<b>50</b>	500	No	265418	0.021
555-23BKT	486	<b>1</b>	1	No	735324	15.9	558-23	490	<b>100</b>	1000	No	266606	0.009
555-23PK2	486	10	10	Yes	200921	0.186	558-23B	490	<b>100</b>	1000	No	267788	0.0092
555-23PK3	486	1	10	Yes	205193	0.9434	558-2PK2	489	10	10	Yes	201522	0.1263
555-23S	486	<b>300</b>	300	No	266330	0.0162	558-3	489	<b>50</b>	500	No	265425	0.0164
555-2BKT	485	<b>1</b>	1	No	735331	18.65	558-3PK2	489	10	10	Yes	201560	0.1033
555-3	485	<b>100</b>	1000	No	265333	0.0148	558-4	489	<b>25</b>	250	No	265432	0.0163
555-3BKT	485	<b>1</b>	1	No	735263	17.15	558-E1	489	<b>50</b>	500	No	203366	0.0235
555-4	485	<b>50</b>	500	No	265340	0.0236	558-E2	489	<b>50</b>	500	No	265388	0.0193
555-4BKT	485	<b>1</b>	1	No	735270	15.99	558-E2PK2	489	10	10	Yes	201300	0.1257
555-623	486	<b>100</b>	1000	No	203007	0.0135	558-E3	489	<b>50</b>	500	No	265395	0.0174
555-623PK2	486	<b>10</b>	10	Yes	267863	0.166	558-E3PK2	489	10	10	Yes	201348	0.1167
556-2	485	<b>100</b>	1000	No	206992	0.0094	558-E4	489	<b>25</b>	250	No	265401	0.0163
556-2BKT	485	<b>1</b>	1	No	735287	18.816	558-E4PK2	489	10	10	Yes	201379	0.0929
556-2PK2	485	<b>10</b>	10	Yes	200747	0.0943	558-M23	489	<b>100</b>	1000	No	201607	0.0072
556-2PK3	485	<b>1</b>	10	Yes	200761	0.9433	558-M23H	489	<b>100</b>	1000	No	201980	0.0084
556-2S	485	<b>300</b>	300	No	203076	0.0117	558-M23PK2	489	10	10	Yes	201508	0.055
556-3	485	<b>100</b>	1000	No	206985	0.0145	558-M23R	489	<b>100</b>	1000	No	201928	0.0072
556-3BKT	485	<b>1</b>	1	No	735294	14.75	558-M4	489	<b>25</b>	250	No	203441	0.0062
556-3PK2	485	<b>10</b>	10	Yes	200785	0.178	558-M4H	489	<b>50</b>	1000	No	266798	0.0051
556-3PK3	485	<b>1</b>	10	Yes	200808	1.5199	558-M4R	489	<b>25</b>	250	No	203458	0.0063
556-3S	485	<b>300</b>	300	No	203120	0.0155	559-2	488	<b>100</b>	1000	No	265364	0.0105
556-4	485	<b>50</b>	500	No	206954	0.0268	559-2PK2	488	10	10	Yes	201102	0.0779
556-4BKT	485	<b>1</b>	1	No	735232	14.5688	559-3	488	<b>50</b>	1000	No	203311	0.0136
556-4C	485	<b>50</b>	500	No	203151	0.0252	559-3PK2	488	10	10	Yes	201140	0.0914
556-4PK2	485	10	10	Yes	266989	0.289	559-4	488	<b>50</b>	500	No	200235	0.0191
556-4PK3	485	<b>1</b>	10	Yes	200822	1.3831	559-4PK2	488	10	10	Yes	265371	0.1235
556-5	485	<b>250</b>	250	No	203915	0.0359	559-5	488	<b>25</b>	250	No	200242	0.0322
556-5S	485	<b>25</b>	100	No	204295	0.0362	559-6	488	<b>25</b>	250	No	200280	0.037
557-2	488	<b>100</b>	1000	No	206893	0.0089	559-7	488	<b>25</b>	250	No	200303	0.0498
557-2PK2	488	10	10	Yes	201706	0.0714	559-7PK2	488	10	10	Yes	203427	0.145
557-2Q	488	<b>50</b>	50	No	203182	0.0331	559F2	488	<b>100</b>	1000	No	203571	0.0193
557-3	488	<b>100</b>	1000	No	203199	0.0115	559F3	488	<b>50</b>	500	No	203403	0.0253
557-3PK2	488	10	10	Yes	201720	0.0814	559F4	488	<b>50</b>	500	No	203397	0.0364
557-3Q	488	<b>50</b>	50	No	318978	0.0041	559F5	488	10	10	No	200754	0.0746
557-4	488	<b>50</b>	500	No	203212	0.0156	559F6	488	10	10	No	200778	0.0836
557-4PK2	488	10	10	Yes	200150	0.0993	559F7	488	10	10	No	200792	0.0905
557-4Q	488	<b>25</b>	25	No	318954	0.0407	570	538	<b>24</b>	24	No	203632	0.2771
557-5	488	<b>25</b>	250	No	206978	0.0256	570-10	538	24	24	Yes	203649	0.45

Item No	Page No	Min Qty	Case Qty	UPC Bar-Coded	UPC 6-Digit	Weight (lbs.)	Item No	Page No	Min Qty	Case Qty	UPC Bar-Coded	UPC 6-Digit	Weight (lbs.)
570-20	538	<b>24</b>	24	Yes	203656	0.5737	591-06B	519	<b>10</b>	10	Yes	266958	0.335
570-22	538	24	24	Yes	203380	0.5697	591-081	499	<b>10</b>	10	No	266309	0.5313
570-24	538	24	24	Yes	203670	0.566	591-081	519	<b>10</b>	10	No	266309	0.5313
570-53	538	50	1000	Yes	203373	0.036	598-010	555	1	1	Yes	200617	14.645
570-58	538	<b>50</b>	50	Yes	203663	0.063	598-011	555	1	1	Yes	200648	14.305
572	538	24	24	No	265869	0.3491	598-012	555	1	1	Yes	200679	22.2
572-20	538	24	24	Yes	203793	0.6133	598-0210	555	<b>10</b>	10	No	202949	0.2285
572-22	538	24	24	Yes	203809	0.6093	598-0210PK1	555	1	25	Yes	204684	0.234
572-24	538	24	24	Yes	203816	0.6333	598-0210PK2	555	1	25	Yes	204691	0.4246
572-53	538	50	250	Yes	208132	0.0369	598-0213	555	<b>10</b>	10	No	202963	0.2745
574-710	500	<b>10</b>	10	No	202888	0.1605	598-0213PK1	555	1	25	Yes	204738	0.2858
574-710	539	<b>10</b>	10	No	202888	0.1605	598-0213PK2	555	1	25	Yes	204745	0.5196
574-713	500	<b>10</b>	10	No	202895	0.2085	598-022	555	<b>10</b>	10	Yes	733474	1.33
574-713	539	<b>10</b>	10	No	202895	0.2085	598-023	555	<b>10</b>	10	Yes	733719	1.78
574-72	500	<b>50</b>	50	No	506658	0.1081	600-206PK	103	<b>10</b>	10	Yes	400567	0.1678
574-72	538	<b>50</b>	50	No	506658	0.1081	600-212PK	103	<b>10</b>	10	Yes	400628	0.3251
574-72	539	<b>50</b>	50	No	506658	0.1081	600-306PK	103	<b>10</b>	10	Yes	400765	0.2528
574-74	500	<b>50</b>	50	No	200686	0.0905	600-312PK	103	<b>10</b>	10	Yes	400826	0.4951
574-74	538	<b>50</b>	50	No	200686	0.0905	600Q206	124	<b>6</b>	6	Yes	201546	0.195
574-74	539	<b>50</b>	50	No	200686	0.0905	600Q306	124	<b>6</b>	6	Yes	201577	0.2925
574-75	500	<b>50</b>	50	No	506665	0.1041	600QG406	124	<b>6</b>	6	Yes	415813	0.5417
574-75	538	<b>50</b>	50	No	506665	0.1041	601-G20CV	111	6	6	Yes	415646	0.6908
574-75	539	<b>50</b>	50	No	506665	0.1041	601-G21CV	111	6	6	Yes	415660	0.6858
574-77	500	<b>50</b>	50	No	506641	0.1299	601-G30CV	111	6	6	Yes	415677	0.8567
574-77	538	<b>50</b>	50	No	506641	0.1299	601Q20V	129	6	6	Yes	416568	0.5583
574-77	539	<b>50</b>	50	No	506641	0.1299	601Q30V	129	6	6	Yes	416520	0.7333
575-100Q	541	1	12	No	268365	2.0704	603Q2	39	<b>15</b>	15	Yes	407917	0.03
575-101Q	541	<b>1</b>	10	No	203359	1.772	603Q2	127	<b>15</b>	15	Yes	407917	0.03
575-102Q	541	<b>1</b>	10	No	203496	4.1	603Q3	39	<b>15</b>	15	Yes	407924	0.0433
575-510Q	541	25	25	No	200815	0.0544	603Q3	127	<b>15</b>	15	Yes	407924	0.0433
575-511Q	541	25	25	No	200839	0.0938	603Q4	39	15	15	Yes	407931	0.05
575-512Q	541	25	25	No	200860	0.2016	603Q4	127	15	15	Yes	407931	0.05
590-10	499	<b>10</b>	10	Yes	503022	1.0693	605QG2	125	<b>12</b>	12	Yes	415820	0.0879
590-4411	499	1	5	Yes	267931	1.56	605QG3	125	<b>6</b>	6	Yes	415837	0.1583
590-4411	548	1	5	Yes	267931	1.56	605QG4	125	<b>6</b>	6	Yes	415844	0.2342
590-4411-3	499	1	5	Yes	200136	1.894	605QG5	125	<b>3</b>	3	Yes	415851	0.5417
590-4411-3	548	1	5	Yes	200136	1.894	605QG6	125	<b>3</b>	3	Yes	415868	0.8517
590-4412	499	1	5	Yes	267948	1.72	605QG7	125	<b>3</b>	3	Yes	415875	1.2183
590-4412	548	1	5	Yes	267948	1.72	608-D288E	104	25	25	No	400284	0.5812
590-4413	499	1	5	Yes	267955	1.54	608-L2138	103	50	50	No	400574	0.4614
590-4413	548	1	5	Yes	267955	1.54	608-L2187	103	50	50	No	400581	0.5506
590-4421	499	1	5	Yes	267962	1.91	608-L2277	103	50	50	No	400598	0.7503
590-4421	548	1	5	Yes	267962	1.91	608-L2308	107	25	25	No	400604	0.8608
590-4423	499	1	5	Yes	267986	2.1	608-L246	103	50	50	No	400673	0.203
590-4423	548	1	5	Yes	267986	2.1	608-L248	103	50	50	No	400680	0.238
590-44ND1	499	1	12	Yes	267993	0.0904	608-L2508	107	25	25	No	400710	1.377
590-44ND1	548	1	12	Yes	267993	0.0904	608-L2508E	107	25	25	No	400727	1.4965
590-44ND2	499	1	12	Yes	268006	0.1124	608-L263A	106	<b>50</b>	50	No	401243	0.1772
590-44ND2	548	1	12	Yes	268006	0.1124	608-L2812	103	50	50	No	400789	0.4415
591-06B	499	<b>10</b>	10	Yes	266958	0.335	608-L348	103	50	50	No	400796	0.4315

Supply

Drainage

Support

Specialties

Appendix

# Numerical Index

Supply

Drainage

Support

Specialties

Appendix

Item No	Page No	Min Qty	Case Qty	UPC Bar-Coded	UPC 6-Digit	Weight (lbs.)	Item No	Page No	Min Qty	Case Qty	UPC Bar-Coded	UPC 6-Digit	Weight (lbs.)
608-L4612	103	25	25	No	400291	0.892	615W216	53	<b>25</b>	25	No	102423	0.194
609-L2138	103	50	50	No	400857	0.462	615W216	101	<b>25</b>	25	No	102423	0.194
609-L246	103	50	50	No	400864	0.2069	616-02BM	640	1	25	Yes	715579	0.13
609-L246E	103	25	25	No	400871	0.2985	616-02C	640	25	25	Yes	506894	0.1147
609-L248	103	50	50	No	400888	0.2426	616-02RB	640	1	25	Yes	403551	0.1113
609-L248E	103	25	25	No	400895	0.3	616-02SN	640	1	25	Yes	506931	0.1113
609-L2612	103	50	50	No	400901	0.3962	616-15	107	25	25	No	401359	0.1567
609-L2812	103	50	50	No	400956	0.438	616-2	101	<b>50</b>	50	No	401366	0.389
609-L348	103	50	50	No	400970	0.417	616-2E3	101	<b>50</b>	50	No	419101	0.2691
609-L4612	103	25	25	No	401007	0.944	616-2PK2	101	<b>10</b>	10	Yes	401625	0.4397
609-L4812	103	25	25	No	401014	1.0461	616-3E3	101	<b>25</b>	25	No	444547	0.37
612-108	105	25	25	No	401021	0.4588	616-630	107	<b>50</b>	50	No	401380	0.924
612-2S	500	<b>50</b>	500	No	207708	0.021	616-630X	107	<b>50</b>	50	No	401397	0.9339
612-3S	500	<b>25</b>	250	No	207715	0.0186	616-630Y	107	<b>50</b>	50	No	401403	0.979
612-4S	500	<b>25</b>	250	No	207722	0.016	616-648	107	<b>12</b>	12	No	401410	1.2057
612-557	105	25	25	No	401038	0.4011	616-650	107	<b>25</b>	25	No	401427	1.364
612-57	105	25	25	No	464101	0.3168	616-650X	107	<b>25</b>	25	No	401434	1.67
612-87	105	25	25	No	401045	0.3904	616-650Y	107	<b>25</b>	25	No	401441	1.484
613-107	105	50	50	No	401069	0.372	616-CG2E3	81	<b>50</b>	50	No	412355	0.1619
613-137	105	<b>50</b>	50	No	401076	0.4388	616X2PX	22	<b>50</b>	50	No	482969	0.4435
613-139	105	50	50	No	401083	0.4833	622-L03	106	100	100	No	410054	0.0703
613-57	105	<b>50</b>	50	No	401090	0.2576	622-L06	106	<b>100</b>	100	No	401489	0.1331
613-57M	105	<b>50</b>	50	No	401113	0.3238	622-L06PK	106	<b>20</b>	20	Yes	400079	0.1425
613-57PK	105	<b>20</b>	20	Yes	401052	0.268	622-L08	106	<b>100</b>	100	No	401496	0.1767
613-57X	105	<b>50</b>	50	No	401120	0.33	622-L08PK	106	<b>10</b>	10	Yes	703491	0.183
613-57Y	105	<b>50</b>	50	No	401137	0.3111	622-L09CF	103	25	25	No	401533	0.2856
613-67	105	<b>50</b>	50	No	401144	0.2794	622-L10	106	100	100	No	401540	0.2255
613-67F	105	<b>50</b>	50	No	498397	0.3716	622-L12	106	<b>100</b>	100	No	401557	0.2653
613-67M	105	<b>50</b>	50	No	401151	0.3496	622-L12PK	106	<b>10</b>	10	Yes	711694	0.2911
613-67X	105	<b>50</b>	50	No	401168	0.36	622-L15	106	100	100	No	401564	0.3315
613-67Y	105	<b>50</b>	50	No	401175	0.3411	622-L24E	106	20	20	No	401601	0.61
613-87	105	<b>50</b>	50	No	401182	0.3252	623-L06	106	50	50	No	401700	0.222
613-87E	105	25	25	No	401199	0.4003	623-L08	106	50	50	No	401717	0.291
613-87M	105	50	50	No	401205	0.3896	623-L12	106	50	50	No	401724	0.436
613-87X	105	<b>50</b>	50	No	401212	0.3987	623-L18	106	50	50	No	401755	0.6636
613-87Y	105	<b>50</b>	50	No	401229	0.3869	624-L08	106	30	30	No	401809	0.4167
613-887L	104	25	25	No	403537	0.5148	624-L12	106	30	30	No	401823	0.6033
613-887R	104	25	25	No	403544	0.5148	624-L15	106	30	30	No	401847	0.7733
614-2	101	<b>50</b>	500	No	401526	0.0319	624-L18	106	30	30	No	401854	0.9676
614-3	101	<b>50</b>	500	No	401250	0.0395	630-C2412	83	<b>50</b>	50	No	401960	0.362
614-4	101	<b>25</b>	250	No	401267	0.0604	630-C248	83	<b>50</b>	50	No	401977	0.2686
614-8L	106	<b>50</b>	50	No	401281	0.2481	630-C248E	83	<b>25</b>	25	No	401984	0.3359
615-213	101	<b>10</b>	10	No	401298	0.2925	630-C248PK	83	<b>10</b>	10	Yes	490735	0.2937
615-233	101	<b>10</b>	10	No	401311	0.309	630-C287	83	<b>50</b>	50	No	401991	0.3454
615-313	101	<b>10</b>	10	No	495112	0.395	630-C348	83	<b>50</b>	50	No	401618	0.7196
615-333	101	<b>10</b>	10	No	495129	0.4619	630-C3612	83	<b>25</b>	25	No	406026	0.662
615-C2113	82	<b>25</b>	25	No	495358	0.566	630-C41016	83	<b>25</b>	25	No	418364	1.416
615-C2113	101	<b>25</b>	25	No	495358	0.566	630-C41110	83	<b>25</b>	25	No	400338	1.1968
615-C215	82	<b>10</b>	10	No	499295	0.314	630-C41110E	83	<b>10</b>	10	No	407481	1.215
615-C215	101	<b>10</b>	10	No	499295	0.314	630-C9248	92	<b>50</b>	50	No	402585	0.291

Item No	Page No	Min Qty	Case Qty	UPC Bar-Coded	UPC 6-Digit	Weight (lbs.)	Item No	Page No	Min Qty	Case Qty	UPC Bar-Coded	UPC 6-Digit	Weight (lbs.)
630-C93612	92	<b>25</b>	25	No	410122	0.66	<b>632-C263PK</b>	83	<b>10</b>	10	Yes	491466	0.2015
<b>630-C941012</b>	92	<b>25</b>	25	No	410252	1.182	<b>632-C263X</b>	83	<b>50</b>	50	No	403278	0.2748
630Q248	128	<b>20</b>	20	Yes	409355	0.3157	<b>632-C263XPX</b>	83	<b>10</b>	10	Yes	499936	0.294
<b>630Q248E</b>	128	<b>10</b>	10	Yes	421814	0.299	<b>632-C263YPK</b>	83	<b>10</b>	10	Yes	499943	0.2751
630Q368	128	<b>10</b>	10	Yes	410740	0.5735	<b>632-C283</b>	83	<b>50</b>	50	No	402530	0.248
<b>630Q4910E</b>	128	<b>10</b>	10	Yes	417756	1.095	<b>632PX222M</b>	45	<b>1</b>	10	No	438270	0.64
630VG248	71	<b>25</b>	25	No	416872	0.3773	<b>632PX232M</b>	45	<b>1</b>	10	No	438904	0.725
<b>630VG248E</b>	71	<b>25</b>	25	No	413314	0.3773	<b>632PX332M</b>	45	<b>1</b>	10	No	438973	0.835
<b>630WG2138</b>	54	<b>50</b>	50	No	406712	0.5504	<b>632Q263</b>	128	<b>20</b>	20	Yes	409362	0.215
<b>630WG2412</b>	54	<b>50</b>	50	No	412898	0.385	<b>632Q263X</b>	128	<b>20</b>	20	Yes	409379	0.3118
<b>630WG248</b>	54	<b>50</b>	50	No	404633	0.31	<b>632Q263Y</b>	128	<b>20</b>	20	Yes	409386	0.2922
<b>630WG248E</b>	54	<b>25</b>	25	No	404640	0.3378	<b>632QG222F</b>	126	<b>6</b>	6	Yes	415882	0.16
<b>630WG248EPK1</b>	54	<b>10</b>	10	Yes	422279	0.4071	<b>632QG222M</b>	126	<b>6</b>	6	Yes	415899	0.193
<b>630WG248PK1</b>	54	<b>10</b>	10	Yes	422286	0.3506	<b>632QK000M</b>	718	<b>5</b>	60	Yes	681003	-
<b>630WG348</b>	54	<b>25</b>	25	No	404657	0.5698	<b>632QK002M</b>	718	<b>5</b>	60	Yes	681010	-
<b>630WG348E</b>	54	<b>25</b>	25	No	404664	0.6224	<b>632QK110M</b>	718	<b>5</b>	60	Yes	437228	-
<b>630WG4612</b>	54	<b>25</b>	25	No	406705	1.1985	<b>632QK111M</b>	718	<b>5</b>	60	Yes	681034	-
<b>630WG4612E</b>	54	<b>10</b>	10	No	406699	1.2885	<b>632QK221M</b>	718	<b>5</b>	60	Yes	681041	-
<b>630WGD288E</b>	54	<b>25</b>	25	No	406682	0.6452	<b>632QK222M</b>	718	<b>5</b>	60	Yes	681058	-
<b>630X146</b>	25	50	50	No	402035	0.2014	<b>632VG273</b>	71	<b>50</b>	50	No	416940	0.246
<b>630X148</b>	25	50	50	No	400345	0.2426	<b>632W273X</b>	55	<b>50</b>	50	No	402387	0.3342
<b>630X148E</b>	25	25	25	No	400369	0.3045	<b>632WG222M</b>	52	<b>50</b>	50	No	409416	0.259
<b>630X2138</b>	25	50	50	No	403445	0.457	<b>632WG222MPK2</b>	52	<b>10</b>	10	Yes	418913	0.5285
<b>630X2412</b>	25	50	50	No	400376	0.3398	<b>632WG263</b>	55	<b>50</b>	50	No	406743	0.2513
<b>630X2412E</b>	25	<b>25</b>	25	No	441706	0.3843	<b>632WG263Y</b>	55	<b>50</b>	50	No	406736	0.2902
<b>630X246</b>	25	<b>50</b>	50	No	403438	0.2014	<b>632WG332</b>	52	<b>25</b>	25	No	409423	0.235
<b>630X246E</b>	25	<b>25</b>	25	No	402097	0.2606	<b>632WG335</b>	53	<b>25</b>	25	No	409430	0.163
<b>630X248</b>	25	<b>50</b>	50	No	402110	0.2426	<b>632WP222M</b>	65	<b>25</b>	375	No	423702	0.0224
<b>630X248E</b>	25	<b>25</b>	25	No	495266	0.3018	<b>632X222</b>	23	<b>100</b>	1000	No	402448	0.0453
<b>630X248EPK</b>	25	<b>20</b>	20	Yes	480965	0.2981	<b>632X225</b>	23	<b>100</b>	1000	No	402462	0.0502
<b>630X248PK</b>	25	<b>6</b>	6	Yes	480941	0.2504	<b>632X243</b>	26	<b>50</b>	50	No	402486	0.1291
<b>630X3136</b>	25	50	50	No	402134	0.666	<b>632X243PK</b>	26	<b>20</b>	20	Yes	481467	0.1564
<b>630X3412</b>	25	50	50	No	400352	0.5745	<b>632X263</b>	26	50	50	No	402493	0.1877
<b>630X348</b>	25	<b>50</b>	50	No	402158	0.4338	<b>632X263X</b>	26	<b>50</b>	50	No	402509	0.2583
<b>630X348E</b>	25	<b>25</b>	25	No	403339	0.4942	<b>632X263Y</b>	26	<b>50</b>	50	No	402516	0.2394
<b>630X4612</b>	25	25	25	No	410184	0.8818	<b>632X283</b>	26	50	50	No	482419	0.2196
<b>630X468</b>	25	25	25	No	410177	0.676	<b>632X332</b>	23	<b>25</b>	250	No	402523	0.0972
<b>630X468E</b>	25	10	10	No	441713	0.765	<b>632X335</b>	23	<b>25</b>	250	No	402547	0.109
<b>630XD288</b>	25	25	25	No	487117	0.53	<b>632X458</b>	26	<b>25</b>	25	No	499820	0.612
<b>631-33</b>	108	1	25	No	407641	0.322	<b>632XG222M</b>	22	<b>50</b>	50	No	404497	0.086
<b>631-33F</b>	107	<b>25</b>	25	No	403315	0.2633	<b>632XG332M</b>	22	<b>50</b>	50	No	404510	0.398
<b>631-C307</b>	84	<b>25</b>	25	No	402196	0.4578	<b>633-312</b>	108	<b>25</b>	25	No	402592	0.5587
<b>631-CG307FP</b>	84	<b>10</b>	10	No	411389	1.205	<b>633-318</b>	108	<b>10</b>	10	No	402455	0.7842
<b>631-G305FP</b>	107	<b>25</b>	25	No	413338	0.0276	<b>633-C02</b>	81	<b>50</b>	50	No	402691	0.1983
<b>631WG02</b>	55	25	25	No	709455	0.352	<b>633-C02</b>	84	<b>50</b>	50	No	402691	0.1983
<b>631WG02FP</b>	55	<b>12</b>	12	No	411785	1.06	<b>633-C02PK</b>	81	<b>10</b>	10	Yes	493101	0.2112
<b>631X02</b>	26	<b>25</b>	25	No	402257	0.3167	<b>633-C02PK</b>	84	<b>10</b>	10	Yes	493101	0.2112
<b>631XG02FP</b>	26	<b>12</b>	12	No	411808	1.115	<b>633-C09</b>	84	<b>25</b>	25	No	402707	0.4413
<b>631XG3TM9</b>	26	<b>25</b>	25	No	713681	0.794	<b>633-C18</b>	84	<b>25</b>	25	No	402721	0.7803
<b>632-C263</b>	83	<b>50</b>	50	No	402332	0.1892	<b>633-C24</b>	84	<b>25</b>	25	No	402776	0.9744

Supply

Drainage

Support

Specialties

Appendix

# Numerical Index

Supply

Drainage

Support

Specialties

Appendix

Item No	Page No	Min Qty	Case Qty	UPC Bar-Coded	UPC 6-Digit	Weight (lbs.)	Item No	Page No	Min Qty	Case Qty	UPC Bar-Coded	UPC 6-Digit	Weight (lbs.)
633-C418	84	<b>25</b>	25	No	402806	0.8962	<b>634-4F4F18</b>	110	<b>10</b>	40	Yes	502438	0.7475
633-C4403	81	<b>20</b>	20	No	402868	0.4033	<b>634-C118</b>	84	<b>25</b>	25	No	402998	0.612
633-CG18FP	84	<b>10</b>	10	No	411419	1.382	<b>634-CG118FP</b>	85	<b>25</b>	25	No	407887	1.16
633-CG18FPT	84	<b>10</b>	10	No	411426	1.695	<b>634Q418</b>	129	<b>12</b>	12	No	410757	0.6498
633-CG18FRV	84	<b>10</b>	10	No	415554	1.6	<b>634Q418FP</b>	129	<b>10</b>	10	No	410764	1.3857
633-CG18HRV	84	<b>10</b>	10	No	723284	15.7	<b>634WG418</b>	56	<b>25</b>	25	No	406767	0.6443
633-CG418FP	84	<b>10</b>	10	No	411440	1.5305	<b>634WG418FP</b>	56	<b>25</b>	25	No	407894	1.168
633-G312FP	108	<b>10</b>	10	No	411709	1.2535	<b>634X418</b>	27	<b>10</b>	10	Yes	403018	0.5554
633-G318FP	108	<b>10</b>	10	No	412904	1.7083	<b>634XG418FP</b>	27	<b>25</b>	25	Yes	407900	1.106
633-G3TM11	109	<b>25</b>	25	No	411464	0.7266	<b>636-3L10888</b>	111	<b>10</b>	10	No	403094	1.856
633-G3TM15	109	<b>25</b>	25	No	411518	0.8714	<b>636-3TR</b>	111	25	25	No	403117	0.6752
633-G3TM18FP	109	1	25	No	407658	1.496	<b>636-4L10888</b>	111	<b>10</b>	10	No	403124	2.16
633-G3TM18FPF	109	1	25	No	407665	1.522	<b>636X38883</b>	27	<b>12</b>	12	No	403162	1.5937
633-G4TM15	109	<b>25</b>	25	No	411877	1.1371	<b>636X48884</b>	27	<b>12</b>	12	No	403193	2.0071
633Q03	125	<b>12</b>	12	Yes	410986	0.218	<b>637-B23HWP</b>	618	<b>5</b>	20	Yes	447050	0.17
633Q06FP	128	<b>10</b>	10	Yes	410825	1.1254	<b>637-C20</b>	81	<b>25</b>	25	No	403209	0.1108
633Q18	128	<b>10</b>	10	Yes	410832	0.8103	<b>637-C20PK2</b>	81	<b>10</b>	10	Yes	493088	0.1331
633Q18FP	128	<b>10</b>	10	Yes	410849	1.4	<b>637-G23H</b>	102	<b>20</b>	20	No	205124	0.1925
633VG18	72	<b>10</b>	10	No	411846	0.7756	<b>637-G23H</b>	618	<b>20</b>	20	No	205124	0.1925
633VG18FP	72	<b>10</b>	10	No	411815	1.415	<b>637PX20</b>	45	<b>1</b>	10	Yes	439451	1.54
633WG18	55	<b>25</b>	25	No	406750	0.8503	<b>637PX25</b>	45	<b>1</b>	10	No	439482	1.73
633WG18FP	55	<b>10</b>	10	No	411839	1.63	<b>637Q2</b>	125	<b>12</b>	12	Yes	410979	0.1238
633WG18FPT	55	<b>10</b>	10	No	416612	1.66	<b>637QK900</b>	718	<b>5</b>	60	Yes	681065	-
633WG18FRV	55	10	10	No	713605	1.6	<b>637QK911</b>	718	<b>5</b>	60	Yes	437457	-
633WG18HRV	55	<b>10</b>	10	No	723260	1.585	<b>637QK911M</b>	718	<b>5</b>	60	Yes	681089	-
633WG18PK1	55	<b>10</b>	10	Yes	406750	0.89	<b>637QK980M</b>	718	<b>5</b>	60	Yes	681096	-
633WG18WRV	55	<b>10</b>	10	No	723277	-	<b>637WP20</b>	65	<b>25</b>	500	No	423719	0.0286
633WG306FP	55	<b>10</b>	10	No	433220	0.855	<b>637WP25</b>	65	<b>25</b>	375	No	423726	0.0334
633X02	27	<b>25</b>	25	No	495433	0.1599	<b>637X20</b>	23	<b>50</b>	500	No	481542	0.0405
633X18	27	<b>25</b>	25	No	402882	0.7534	<b>637X20PK2</b>	23	<b>10</b>	10	Yes	481528	0.1069
633X18PK	27	<b>25</b>	25	Yes	484468	0.7364	<b>637X235</b>	22	<b>50</b>	50	No	403254	0.1816
633XG18FP	27	<b>10</b>	10	Yes	412867	1.5219	<b>637X25</b>	23	<b>50</b>	50	No	481580	0.0606
633XG18FPT	27	<b>10</b>	10	No	412942	1.6675	<b>637X335</b>	22	<b>25</b>	25	No	487902	0.1868
633XG18FRV	27	<b>10</b>	10	No	416773	1.615	<b>637X423PK</b>	23	<b>10</b>	10	Yes	401663	0.1209
633XG18HRV	27	<b>10</b>	10	No	723291	1.555	<b>637XG711</b>	24	<b>20</b>	20	No	423047	0.0965
633XG18XRV	27	<b>10</b>	10	No	723307	15.1	<b>637XG721</b>	24	<b>20</b>	20	No	423030	0.095
634-112	109	<b>12</b>	12	No	400413	0.4367	<b>637XG920</b>	29	<b>25</b>	250	No	415301	0.11
634-112PK5	109	<b>5</b>	5	Yes	409034	0.47	<b>637XG920PK1</b>	29	<b>10</b>	10	Yes	415318	0.16
634-115	109	<b>12</b>	12	No	402936	0.5075	<b>637XG9220</b>	29	<b>25</b>	250	No	415325	0.1229
634-118	109	<b>12</b>	12	No	402943	0.601	<b>637XG9220PK1</b>	29	<b>10</b>	10	Yes	415493	0.0215
634-118PK5	109	<b>5</b>	5	Yes	409096	0.6317	<b>638VG208E4</b>	71	<b>25</b>	25	No	421968	0.3122
634-124	109	<b>12</b>	12	No	400437	0.8067	<b>638VG218E4</b>	71	<b>25</b>	25	No	421951	0.5265
634-124PK5	109	<b>5</b>	5	Yes	409119	0.8296	<b>638WG208</b>	54	<b>50</b>	50	No	411150	0.2435
634-315	109	<b>12</b>	12	No	402974	0.456	<b>638WG212E</b>	54	<b>50</b>	50	No	406774	0.3677
634-318	109	<b>12</b>	12	No	402981	0.54	<b>638WG215</b>	54	<b>50</b>	50	No	411167	0.3968
634-324	109	<b>12</b>	12	No	408983	0.664	<b>638X208</b>	26	<b>100</b>	100	No	403360	0.1785
634-3F3F12	110	<b>10</b>	40	Yes	502469	0.3762	<b>638X208PK</b>	26	<b>20</b>	20	Yes	481306	0.1906
634-3F3F18	110	<b>10</b>	40	Yes	502476	0.5012	<b>638X212</b>	26	100	100	No	481320	0.2613
634-3F3F24	110	<b>10</b>	40	Yes	502483	0.5975	<b>638X212E</b>	26	<b>50</b>	50	No	499837	0.3187
634-4F3F18	110	<b>10</b>	40	Yes	502421	0.57	<b>638X218E</b>	26	<b>25</b>	25	No	418746	0.4211

Item No	Page No	Min Qty	Case Qty	UPC Bar-Coded	UPC 6-Digit	Weight (lbs.)	Item No	Page No	Min Qty	Case Qty	UPC Bar-Coded	UPC 6-Digit	Weight (lbs.)
638X312	26	50	50	No	403384	0.4503	641WG322	49	<b>20</b>	20	No	409461	0.2751
640PX12	44	<b>1</b>	20	No	439932	0.2625	641WG323	49	<b>20</b>	20	No	409478	0.2766
640PX13	44	<b>1</b>	20	No	440358	0.26	641WG332	49	<b>20</b>	20	No	409485	0.2913
640PX14	44	<b>1</b>	10	No	442666	0.0169	641WG333	49	<b>20</b>	20	No	409492	0.265
640WP02	64	<b>25</b>	1000	No	423733	0.008	641WG334	49	<b>20</b>	20	No	409508	0.4425
640WP03	64	<b>25</b>	750	No	423740	0.0088	641WG433	49	<b>20</b>	20	No	409515	0.4575
640WP04	64	<b>10</b>	360	No	423757	0.0271	641WG442	49	<b>20</b>	20	No	409522	0.474
640WP5	64	<b>1</b>	5	Yes	710130	-	641WG443	49	<b>20</b>	20	No	409546	0.5
640WP6	64	<b>1</b>	5	Yes	710147	-	641WG444	49	<b>20</b>	20	No	409553	0.5225
640WP7	64	<b>1</b>	5	Yes	710154	-	641WG445	49	<b>5</b>	5	Yes	723321	-
640XG01	19	<b>100</b>	1000	No	404626	0.0161	641WG534	49	<b>5</b>	5	Yes	723338	-
640XG02	19	<b>100</b>	1000	No	408648	0.018	641WG543	49	<b>5</b>	5	No	440556	-
640XG03	19	<b>100</b>	1000	No	408655	0.0354	641WG544	49	<b>5</b>	5	No	440617	-
640XG04	19	<b>25</b>	250	No	408662	0.0764	641WG545	49	<b>5</b>	5	Yes	723345	-
641PX222	44	<b>1</b>	10	No	443618	0.7	641WP222	63	<b>25</b>	500	No	423764	0.0211
641PX223	44	<b>1</b>	10	No	443823	0.45	641WP223	64	<b>25</b>	300	No	423771	0.0278
641PX322	44	<b>1</b>	10	No	450531	0.445	641WP322	63	<b>25</b>	300	No	423788	0.0345
641PX323	44	<b>1</b>	10	No	450982	0.54	641WP323	63	<b>25</b>	250	No	423795	0.0357
641PX332	44	<b>1</b>	10	No	457134	0.496	641WP332	63	<b>25</b>	250	No	423801	0.0338
641PX333	44	<b>1</b>	10	No	457547	0.65	641WP333	63	<b>25</b>	200	No	423818	0.0412
641PX334	44	<b>1</b>	10	No	457844	0.825	641WP334	64	<b>10</b>	140	No	714992	-
641PX433	44	<b>1</b>	10	No	457851	0.97	641WP433	63	<b>10</b>	140	No	715005	0.07
641PX434	44	<b>1</b>	10	No	457882	1.14	641WP434	63	<b>10</b>	120	No	715012	-
641PX442	44	<b>1</b>	10	No	457899	0.0498	641WP442	63	<b>10</b>	150	No	715029	0.0583
641PX443	44	<b>1</b>	10	No	457905	0.0538	641WP443	63	<b>10</b>	120	No	423825	0.0632
641PX444	44	<b>1</b>	10	No	457912	0.0575	641WP444	63	<b>10</b>	100	No	423832	0.089
641Q3-3Q2	124	<b>1</b>	6	Yes	424075	0.4	641WP535	63	<b>1</b>	5	Yes	710161	-
641QG222	123	<b>12</b>	12	Yes	415912	0.2312	641WP543	63	<b>1</b>	5	Yes	715036	-
641QG222F	123	<b>6</b>	6	Yes	415929	0.2492	641WP544	63	<b>1</b>	5	Yes	715043	-
641QG222M	123	<b>6</b>	6	Yes	415936	0.2333	641WP545	63	<b>1</b>	5	Yes	710178	-
641QG223	123	<b>6</b>	6	Yes	415943	0.3083	641WP552	63	<b>1</b>	5	Yes	710185	0.1
641QG224	123	<b>6</b>	6	Yes	415950	0.3833	641WP553	63	<b>1</b>	5	Yes	710192	0.705
641QG322	123	<b>12</b>	12	Yes	415967	0.295	641WP554	63	<b>1</b>	5	Yes	710208	-
641QG323	123	<b>6</b>	6	Yes	415974	0.3692	641WP555	63	<b>1</b>	5	Yes	710215	0.805
641QG332	123	<b>6</b>	6	Yes	415981	0.3558	641WP636	64	<b>1</b>	5	Yes	710222	-
641QG333	123	<b>12</b>	12	Yes	415998	0.3912	641WP646	64	<b>1</b>	5	Yes	710239	-
641QG333F	123	<b>6</b>	6	Yes	416001	0.4925	641WP654	64	<b>1</b>	5	Yes	715081	-
641QG333M	123	<b>6</b>	6	Yes	416018	0.4142	641WP655	64	<b>1</b>	5	Yes	710246	-
641QG334	123	<b>6</b>	6	Yes	416025	0.475	641WP656	64	<b>1</b>	5	Yes	710253	-
641QG424	123	<b>6</b>	6	Yes	416032	0.5408	641WP663	64	<b>1</b>	5	Yes	710260	-
641QG443	123	<b>6</b>	6	Yes	416049	0.5592	641WP664	64	<b>1</b>	5	Yes	710277	-
641QG444	123	<b>6</b>	6	Yes	416056	0.6683	641WP665	64	<b>1</b>	5	Yes	710284	0.99
641QG555	123	<b>3</b>	3	Yes	416063	1.5833	641WP666	63	<b>1</b>	5	Yes	710291	-
641QG666	123	<b>3</b>	3	Yes	416070	2.5167	641WP747	64	<b>1</b>	5	Yes	710307	-
641QG777	123	<b>3</b>	3	Yes	416087	3.8517	641WP757	64	<b>1</b>	5	Yes	710314	-
641QK000	717	<b>5</b>	60	Yes	681102	-	641WP764	64	<b>1</b>	5	Yes	715111	-
641QK111	717	<b>5</b>	60	Yes	681119	-	641WP773	64	<b>1</b>	5	Yes	715166	-
641QK222	717	<b>5</b>	60	Yes	681126	-	641WP774	64	<b>1</b>	5	Yes	710321	-
641WG222	49	<b>50</b>	50	No	409447	0.136	641WP775	64	<b>1</b>	5	Yes	710338	2.2
641WG223	49	<b>20</b>	20	No	409454	0.2534	641WP776	64	<b>1</b>	5	Yes	710345	-

Supply

Drainage

Support

Specialties

Appendix

# Numerical Index

Supply

Drainage

Support

Specialties

Appendix

Item No	Page No	Min Qty	Case Qty	UPC Bar-Coded	UPC 6-Digit	Weight (lbs.)	Item No	Page No	Min Qty	Case Qty	UPC Bar-Coded	UPC 6-Digit	Weight (lbs.)
641WP777	63	<b>1</b>	5	Yes	710352	-	<b>643-C9311</b>	91	<b>25</b>	25	No	410139	0.44
641XG111	18	<b>50</b>	500	No	404893	0.0555	<b>643-C9418</b>	91	<b>25</b>	25	No	410160	0.994
641XG222	18	<b>50</b>	50	No	404909	0.057	<b>643-P311</b>	95	50	50	No	407511	0.4335
641XG223	18	<b>20</b>	200	No	404916	0.1272	<b>643-P418</b>	95	25	25	No	407535	0.974
641XG322	18	<b>20</b>	200	No	404923	0.112	<b>643-P518</b>	95	1	10	No	407528	1.4993
641XG323	18	<b>20</b>	200	No	404930	0.1088	<b>643-P620</b>	95	1	10	No	407542	2.1377
641XG332	18	<b>20</b>	200	No	404947	0.0858	<b>643-P722</b>	95	1	10	No	407559	3.515
641XG333	18	<b>20</b>	200	No	405098	0.0958	<b>643WG2</b>	51	<b>100</b>	100	No	409591	0.0515
641XG442	18	<b>20</b>	200	No	405111	0.1298	<b>643WG23</b>	51	<b>50</b>	50	No	409393	0.094
641XG443	18	<b>20</b>	200	No	405166	0.158	<b>643WG3</b>	51	<b>50</b>	50	No	409669	0.1138
641XG444	18	<b>20</b>	200	No	405234	0.1838	<b>643WG32</b>	51	<b>50</b>	50	No	409409	0.0814
642PX2	43	<b>1</b>	10	No	457936	0.31	<b>643WG4</b>	51	<b>25</b>	25	No	409683	0.2015
642PX3	43	<b>1</b>	10	No	457943	0.59	<b>643WG43</b>	51	<b>25</b>	25	No	409690	0.1412
642PX32	43	<b>1</b>	10	No	457950	0.46	<b>643WG5</b>	51	<b>5</b>	5	No	409706	0.33
642PX4	43	<b>1</b>	10	No	457967	1.21	<b>643WG6</b>	51	<b>5</b>	5	No	409713	0.468
642QG2	123	<b>12</b>	12	Yes	416094	0.2996	<b>643WG7</b>	51	<b>5</b>	5	No	409720	1.0486
642QG3	123	<b>12</b>	12	Yes	416100	0.3017	<b>643X2</b>	20	<b>100</b>	1000	No	481764	0.0262
642QG32	123	<b>6</b>	6	Yes	416117	0.2558	<b>643X202</b>	20	<b>50</b>	500	No	403827	0.0442
642QG4	123	<b>6</b>	6	Yes	416124	0.4942	<b>643X208</b>	26	<b>100</b>	100	No	403834	0.174
642QG43	123	<b>6</b>	6	Yes	416131	0.4067	<b>643X212</b>	26	<b>100</b>	100	No	403841	0.2613
642QG5	123	<b>3</b>	3	Yes	416148	1.195	<b>643X23</b>	20	<b>50</b>	100	No	481771	0.04
642QG6	123	<b>3</b>	3	Yes	416155	1.8833	<b>643X3</b>	20	<b>50</b>	500	No	481849	0.0524
642QG7	123	<b>3</b>	3	Yes	416162	2.8667	<b>643X32</b>	20	<b>50</b>	500	No	481801	0.0528
642QK0	717	<b>5</b>	60	Yes	681133	-	<b>643X34</b>	20	<b>25</b>	250	No	403889	0.0866
642QK1	717	<b>5</b>	60	Yes	681140	-	<b>643X4</b>	20	<b>25</b>	250	No	481924	0.1048
642WG2	49	<b>25</b>	25	No	409560	0.12	<b>643X43</b>	20	<b>25</b>	250	No	403902	0.0846
642WG3	49	<b>25</b>	25	No	409577	0.196	<b>643X5</b>	20	<b>10</b>	10	No	722478	0.175
642WG4	49	<b>25</b>	25	No	409584	0.384	<b>643XG1</b>	20	<b>100</b>	1000	No	408730	0.0339
642WP2	63	<b>25</b>	625	No	423849	0.0146	<b>643XG2</b>	20	<b>100</b>	1000	No	408747	0.0346
642WP3	63	<b>25</b>	375	No	423856	0.0295	<b>643XG23</b>	20	<b>50</b>	500	No	408754	0.0422
642WP4	63	<b>10</b>	160	No	423863	0.0541	<b>643XG3</b>	20	<b>50</b>	500	No	408761	0.0172
642WP5	63	<b>1</b>	5	Yes	710369	0.655	<b>643XG32</b>	20	<b>50</b>	500	No	408778	0.0622
642WP6	63	<b>1</b>	5	Yes	710376	-	<b>643XG34</b>	20	<b>25</b>	250	No	408785	0.076
642WP7	63	<b>1</b>	5	Yes	710383	-	<b>643XG4</b>	20	<b>25</b>	250	No	408792	0.1106
642X2	18	<b>25</b>	250	No	487063	0.0426	<b>643XG43</b>	20	<b>25</b>	250	No	408808	0.1132
642X3	18	<b>25</b>	250	No	487100	0.0899	<b>644WG2</b>	51	<b>100</b>	100	No	409737	0.0661
642X43	18	<b>25</b>	25	No	405937	0.2041	<b>644WG23</b>	51	<b>50</b>	50	No	409676	0.097
642XG1	18	<b>25</b>	250	No	408679	0.0528	<b>644WG3</b>	51	<b>50</b>	50	No	409744	0.1471
642XG2	18	<b>25</b>	250	No	408686	0.0384	<b>644WG32</b>	51	<b>50</b>	50	No	409973	0.0076
642XG23	18	<b>25</b>	250	No	408693	0.0574	<b>644WG4</b>	51	<b>25</b>	25	No	409751	0.2641
642XG3	18	<b>25</b>	250	No	408709	0.0704	<b>644WG5</b>	51	<b>5</b>	5	No	409775	0.354
642XG4	18	<b>25</b>	25	No	408716	0.138	<b>644WG6</b>	51	<b>5</b>	5	No	409782	0.5825
642XG43	18	<b>25</b>	25	No	408723	0.18	<b>644WG7</b>	51	<b>5</b>	5	No	409799	1.0287
643-C211	80	<b>100</b>	100	No	403766	0.2608	<b>644X2</b>	21	<b>100</b>	1000	No	495273	0.0281
643-C311	80	<b>50</b>	50	No	403773	0.4389	<b>644X23</b>	21	<b>25</b>	100	No	443212	0.041
643-C418	80	25	25	No	403780	0.972	<b>644X3</b>	21	<b>50</b>	500	No	495280	0.0569
643-C518	80	10	10	No	407498	1.492	<b>644X32</b>	21	<b>50</b>	500	No	482105	0.0566
643-C620	80	1	10	No	465443	2.1385	<b>644X34</b>	21	<b>25</b>	250	No	403971	0.0756
643-C722	80	1	10	No	407504	3.3069	<b>644X4</b>	21	<b>25</b>	250	No	482266	0.1125
643-C9211	91	<b>25</b>	25	No	402622	0.28	<b>644X43</b>	21	<b>25</b>	250	No	403995	0.1064



Item No	Page No	Min Qty	Case Qty	UPC Bar-Coded	UPC 6-Digit	Weight (lbs.)	Item No	Page No	Min Qty	Case Qty	UPC Bar-Coded	UPC 6-Digit	Weight (lbs.)
644X5	21	<b>10</b>	10	No	722492	0.1816	645WGC3	79	<b>50</b>	50	No	406798	0.159
644XG1	21	<b>100</b>	500	No	408815	0.0435	645WGC4	50	<b>20</b>	20	No	406804	0.4737
644XG2	21	<b>100</b>	1000	No	408822	0.036	645WGC4	79	<b>20</b>	20	No	406804	0.4737
644XG3	21	<b>50</b>	500	No	408839	0.08	645WGC5	50	5	5	No	450159	0.76
644XG32	21	<b>50</b>	500	No	408846	0.0707	645WGC5	79	5	5	No	450159	0.76
644XG4	21	<b>25</b>	250	No	408853	0.065	645WGC6	50	5	5	No	450142	1.01
644XG43	21	<b>25</b>	250	No	408860	0.137	645WGC6	79	5	5	No	450142	1.01
645PX2	44	<b>1</b>	20	No	457981	0.326	645WGC7	50	5	5	No	410283	1.91
645PX3	44	<b>1</b>	20	No	457998	0.3475	645WGC7	79	5	5	No	410283	1.91
645PX32	44	<b>1</b>	20	No	458001	0.2925	645WGC93	50	<b>50</b>	50	No	713308	0.245
645PX4	44	<b>1</b>	10	No	458018	0.64	645WGC93	91	<b>50</b>	50	No	713308	0.245
645PX42	44	<b>1</b>	10	No	458025	0.47	645WGC94	50	<b>20</b>	20	No	713315	0.4025
645PX43	44	<b>1</b>	10	No	458032	0.575	645WGC94	91	<b>20</b>	20	No	713315	0.4025
645Q2-3	124	10	10	Yes	423993	0.145	645WGC95	50	10	10	No	713384	0.795
645Q3-2	124	10	10	Yes	424006	0.17	645WGC95	91	10	10	No	713384	0.795
645QG2	124	<b>12</b>	12	Yes	416179	0.1433	645WP2	64	<b>25</b>	1000	No	423870	0.0121
645QG3	124	<b>12</b>	12	Yes	416186	0.2458	645WP3	64	<b>25</b>	500	No	423894	0.0214
645QG32	124	<b>6</b>	6	Yes	416193	0.2017	645WP32	64	<b>25</b>	500	No	423887	0.0191
645QG4	124	<b>6</b>	6	Yes	416209	0.3492	645WP4	64	<b>10</b>	200	No	423917	0.0392
645QG43	124	<b>6</b>	6	Yes	416216	0.3058	645WP42	64	<b>25</b>	250	No	715180	0.0322
645QG5	124	<b>3</b>	3	Yes	416223	0.9167	645WP43	64	<b>25</b>	250	No	423900	0.0326
645QG54	124	<b>3</b>	3	Yes	416230	0.6833	645WP5	64	<b>1</b>	5	Yes	710390	-
645QG6	124	<b>3</b>	3	Yes	416247	1.5	645WP53	64	<b>1</b>	5	Yes	710406	0.445
645QG65	124	<b>3</b>	3	Yes	416254	1.2017	645WP54	64	<b>1</b>	5	Yes	710413	0.465
645QG7	124	<b>3</b>	3	Yes	416261	2.1167	645WP6	64	<b>1</b>	5	Yes	710420	-
645QG76	124	<b>3</b>	3	Yes	416278	1.8333	645WP65	64	<b>1</b>	5	Yes	710437	-
645QK0	717	<b>5</b>	60	Yes	681157	-	645WP7	64	<b>1</b>	5	Yes	710444	-
645QK1	717	<b>5</b>	60	Yes	681164	-	645WP76	64	<b>1</b>	5	Yes	710451	1.09
645QK10	717	<b>5</b>	60	Yes	681171	-	645X2	19	<b>100</b>	1000	No	482365	0.0234
645QK2	717	<b>5</b>	60	Yes	681188	-	645X23P	20	<b>50</b>	50	No	495983	0.2009
645QK9	717	<b>5</b>	60	Yes	681195	-	645X23P	95	<b>50</b>	50	No	495983	0.2009
645QK90	717	<b>5</b>	60	Yes	681201	-	645X2G	24	<b>50</b>	50	No	482549	0.058
645VGC2	71	<b>50</b>	50	No	413352	0.11	645X2GPK2	24	<b>10</b>	10	Yes	482549	0.0758
645VGC2	79	<b>50</b>	50	No	413352	0.11	645X3	19	<b>50</b>	500	No	482440	0.0382
645VGC3	71	<b>50</b>	50	No	413383	0.215	645X32	19	<b>50</b>	500	No	482402	0.0372
645VGC3	79	<b>50</b>	50	No	413383	0.215	645X34P	20	<b>20</b>	20	No	495853	0.3074
645VGC4	71	<b>20</b>	20	No	413390	0.368	645X34P	95	<b>20</b>	20	No	495853	0.3074
645VGC4	79	<b>20</b>	20	No	413390	0.368	645X3G	24	<b>50</b>	50	No	482563	0.0799
645WG2	50	<b>100</b>	100	No	409805	0.0635	645X3GPK2	24	<b>10</b>	10	Yes	482563	0.0938
645WG3	50	<b>50</b>	50	No	409812	0.1302	645X3P	20	<b>50</b>	50	No	495945	0.2001
645WG32	50	<b>50</b>	50	No	409829	0.1122	645X3P	95	<b>50</b>	50	No	495945	0.2001
645WG3P	50	<b>50</b>	50	No	404879	0.2896	645X4	19	<b>25</b>	250	No	482525	0.0807
645WG3P	95	<b>50</b>	50	No	404879	0.2896	645X43	19	<b>25</b>	250	No	482488	0.0711
645WG4	50	<b>25</b>	25	No	409836	0.2308	645X43P	20	<b>20</b>	20	No	495860	0.2261
645WG43	50	<b>25</b>	25	No	409843	0.1929	645X43P	95	<b>20</b>	20	No	495860	0.2261
645WG4P	50	<b>20</b>	20	No	404886	0.4777	645X4P	20	<b>20</b>	20	No	495846	0.1606
645WG4P	95	<b>20</b>	20	No	404886	0.4777	645X4P	95	<b>20</b>	20	No	495846	0.1606
645WGC2	50	<b>50</b>	50	No	406781	0.076	645X5	19	<b>10</b>	10	No	722508	0.1413
645WGC2	79	<b>50</b>	50	No	406781	0.076	645X54	19	<b>10</b>	10	No	722515	0.1339
645WGC3	50	<b>50</b>	50	No	406798	0.159	645XC2	19	<b>50</b>	50	No	404152	0.0684

Supply

Drainage

Support

Specialties

Appendix

# Numerical Index

Supply

Drainage

Support

Specialties

Appendix

Item No	Page No	Min Qty	Case Qty	UPC Bar-Coded	UPC 6-Digit	Weight (lbs.)	Item No	Page No	Min Qty	Case Qty	UPC Bar-Coded	UPC 6-Digit	Weight (lbs.)
645XC2	79	<b>50</b>	50	No	404152	0.0684	646-CG96	91	10	10	No	708519	0.805
645XC23	19	<b>50</b>	50	No	496225	0.171	646-CG97	91	10	10	No	708526	1.22
645XC23	79	<b>50</b>	50	No	496225	0.171	646-GP4312FD	111	<b>25</b>	25	No	412232	1.509
645XC2PK2	19	<b>10</b>	10	Yes	482051	0.0908	646-GP4412FD	111	<b>25</b>	25	No	412256	2.124
645XC2PK2	79	<b>10</b>	10	Yes	482051	0.0908	646-PG3	96	<b>50</b>	50	No	407177	0.276
645XC3	19	<b>50</b>	50	No	404169	0.1267	646-PG4	96	<b>20</b>	20	No	407191	0.4165
645XC3	79	<b>50</b>	50	No	404169	0.1267	646-PG5	96	10	10	No	404503	0.71
645XC34	19	<b>20</b>	20	No	496119	0.2989	646-PG6	96	10	10	No	404527	0.795
645XC34	79	<b>20</b>	20	No	496119	0.2989	646-PG7	96	10	10	No	404541	1.22
645XC3PK2	19	<b>10</b>	10	Yes	482136	0.1493	646PX2	45	<b>1</b>	10	No	458049	0.166
645XC3PK2	79	<b>10</b>	10	Yes	482136	0.1493	646PX23	45	<b>1</b>	10	No	458056	0.665
645XC4	19	<b>20</b>	20	No	404176	0.2025	646PX3	45	<b>1</b>	10	No	458063	0.65
645XC4	79	<b>20</b>	20	No	404176	0.2025	646PX32	45	<b>1</b>	10	No	458070	0.58
645XC43	19	<b>20</b>	20	No	496201	0.2036	646PX4	45	<b>1</b>	10	No	458087	1.18
645XC43	79	<b>20</b>	20	No	496201	0.2036	646QG2	125	<b>12</b>	12	Yes	416285	0.1333
645XC923	20	25	25	No	713711	0.214	646QG3	125	<b>12</b>	12	Yes	416292	0.2
645XC923	91	25	25	No	713711	0.214	646QG32	125	<b>6</b>	6	Yes	416308	0.2042
645XC93	20	<b>50</b>	50	No	712363	0.142	646QG34	125	<b>6</b>	6	Yes	416315	0.2883
645XC93	91	<b>50</b>	50	No	712363	0.142	646QG4	125	<b>6</b>	6	Yes	416322	0.2883
645XC94	20	<b>20</b>	20	No	712370	0.2125	646QG5	125	<b>3</b>	3	Yes	416339	0.7867
645XC94	91	<b>20</b>	20	No	712370	0.2125	646QG6	125	<b>3</b>	3	Yes	416346	1.0683
645XCM2	19	<b>50</b>	50	No	457042	0.06	646QG7	125	<b>3</b>	3	Yes	416353	1.4833
645XCM2	79	<b>50</b>	50	No	457042	0.06	646QK0	717	<b>5</b>	60	Yes	681218	-
645XG1	19	<b>100</b>	1000	No	408877	0.0211	646QK01	717	<b>5</b>	60	Yes	681225	-
645XG12	19	<b>50</b>	500	No	408884	0.0267	646QK1	717	<b>5</b>	60	Yes	681232	-
645XG2	19	<b>100</b>	1000	No	408891	0.0268	646QK10	717	<b>5</b>	60	Yes	681249	-
645XG3	19	<b>50</b>	500	No	408907	0.048	646QK12	717	<b>5</b>	60	Yes	681256	-
645XG32	19	<b>50</b>	500	No	408914	0.0415	646QK2	717	<b>5</b>	60	Yes	681263	-
645XG4	19	<b>25</b>	250	No	408921	0.0808	646QK20	717	<b>5</b>	60	Yes	681270	-
645XG43	19	<b>25</b>	250	No	408938	0.07	646QK21	717	<b>5</b>	60	Yes	681287	-
645XGC2	19	<b>50</b>	50	No	728579	-	646QK80	717	<b>5</b>	60	Yes	681294	-
645XGC2	79	<b>50</b>	50	No	728579	-	646QK81	717	<b>5</b>	60	Yes	681300	-
645XGC3	19	<b>50</b>	50	No	728586	-	646WG2	51	<b>100</b>	100	No	409850	0.1212
645XGC3	79	<b>50</b>	50	No	728586	-	646WG3	51	<b>25</b>	25	No	409867	0.1883
645XGC4	19	<b>20</b>	20	No	728593	-	646WG32	51	<b>25</b>	25	No	409874	0.184
645XGC4	79	<b>20</b>	20	No	728593	-	646WG34	51	<b>25</b>	25	No	409881	0.226
646-C4308	85	<b>25</b>	25	No	496836	0.5361	646WG4	51	<b>25</b>	25	No	409898	0.2987
646-CG2	80	<b>50</b>	50	No	406897	0.0925	646WG43	51	<b>25</b>	25	No	409904	0.326
646-CG2PK1	80	<b>25</b>	25	Yes	416728	0.0941	646WG5	51	<b>5</b>	5	No	409911	0.654
646-CG3	80	<b>50</b>	50	No	406903	0.1608	646WG6	51	<b>5</b>	5	No	409928	0.89
646-CG318	85	<b>25</b>	25	No	415608	0.786	646WG7	51	<b>5</b>	5	No	409935	1.8665
646-CG318FP	85	<b>10</b>	10	No	415363	1.37	646WP2	65	<b>25</b>	800	No	423924	0.0162
646-CG4	80	<b>20</b>	20	No	406910	0.0618	646WP3	65	<b>25</b>	500	No	423931	-
646-CG5	80	10	10	No	101297	0.535	646WP32	65	<b>10</b>	400	No	423986	0.024
646-CG6	80	10	10	No	101358	0.01	646WP3PK2	65	<b>10</b>	10	Yes	422972	-
646-CG7	80	10	10	No	101402	1.16	646WP4	65	<b>10</b>	200	No	715210	-
646-CG92	91	<b>50</b>	50	No	458285	-	646XG2	21	<b>100</b>	100	No	406958	0.085
646-CG93	91	<b>50</b>	50	No	458292	0.223	646XG23	21	<b>50</b>	50	No	408945	0.088
646-CG94	91	<b>20</b>	20	No	733177	0.3925	646XG3	21	<b>25</b>	250	No	406972	0.1012
646-CG95	91	10	10	No	708502	0.7	646XG32	21	<b>50</b>	50	No	406989	0.128

Item No	Page No	Min Qty	Case Qty	UPC Bar-Coded	UPC 6-Digit	Weight (lbs.)	Item No	Page No	Min Qty	Case Qty	UPC Bar-Coded	UPC 6-Digit	Weight (lbs.)
646XG34	21	<b>25</b>	25	No	406996	0.148	647XG23PK2	21	<b>10</b>	10	Yes	407115	0.2129
646XG4	21	<b>50</b>	50	No	407054	0.206	647XG2E3	22	<b>50</b>	50	No	710000	0.194
646XG43	21	<b>50</b>	50	No	408952	0.2739	647XG2EPK1	22	<b>20</b>	20	No	415585	0.293
647-C3E	81	<b>25</b>	25	No	407566	0.4312	647XG3	21	<b>50</b>	50	No	407139	0.109
647-C4E	81	<b>10</b>	10	No	407573	0.7242	647XG4	21	<b>50</b>	50	No	407153	0.25
647-CG2	80	<b>50</b>	50	No	406927	0.1073	648-3SM	110	<b>5</b>	5	Yes	713070	-
647-CG2E3	81	<b>50</b>	50	No	415530	0.3414	648-3SM	112	<b>5</b>	5	Yes	713070	-
647-CG2E3PK1	81	<b>10</b>	10	Yes	415547	0.341	648-3SMARX	112	<b>6</b>	6	Yes	726421	0.993
647-CG2PK1	80	<b>25</b>	25	Yes	416742	0.1021	648-3SW	56	<b>5</b>	5	Yes	735706	-
647-CG3	80	<b>50</b>	50	No	406934	0.164	648-3SW	110	<b>5</b>	5	Yes	735706	-
647-CG4	80	<b>20</b>	20	No	406941	0.4251	648-3SW	112	<b>5</b>	5	Yes	735706	-
647-CG5	80	10	10	No	101419	0.555	648-3SX	28	<b>5</b>	5	No	735195	0.58
647-CG6	80	10	10	No	101426	0.1266	648-3SX	110	<b>5</b>	5	No	735195	0.58
647-CG7	80	10	10	No	404442	0.2122	648-3SX	112	<b>5</b>	5	No	735195	0.58
647-CG92	92	<b>50</b>	50	No	458308	-	648-ARW	55	<b>6</b>	6	Yes	726285	-
647-CG93	92	<b>50</b>	50	No	458315	0.253	648-ARX	27	<b>6</b>	6	Yes	726278	-
647-CG94	92	20	20	No	733184	-	648-ARX	112	<b>6</b>	6	Yes	726278	-
647-CG95	92	10	10	No	708533	0.59	648-CG2FP	85	<b>10</b>	10	No	411921	0.7025
647-CG96	92	10	10	No	708557	0.765	648-CG2FPD	85	<b>10</b>	10	No	412058	0.536
647-CG97	92	10	10	No	708564	0.925	648-CG3FP	85	<b>10</b>	10	No	412102	1.0427
647-PG3	96	<b>50</b>	50	No	407245	0.292	648-CG3FPD	85	<b>10</b>	10	No	412119	0.8972
647-PG4	96	<b>20</b>	20	No	407252	0.4276	648-CG4FP	85	<b>10</b>	10	No	412126	1.21
647-PG5	96	10	10	No	404688	0.58	648-CG4FPD	85	<b>10</b>	10	No	412133	1.525
647-PG6	96	10	10	No	406224	0.745	648-CG5FP	85	5	5	No	412140	2.7914
647-PG7	96	10	10	No	406491	0.94	648-CG6FP	85	<b>1</b>	1	No	412157	4.3159
647QG2	126	<b>12</b>	12	Yes	416360	0.1458	648-CG7FP	85	<b>1</b>	1	No	412164	6.6868
647QG2E3	126	<b>6</b>	6	Yes	416377	0.2458	648-PG3FP	97	<b>10</b>	10	No	415288	0.9502
647QG3	126	<b>12</b>	12	Yes	416384	0.2408	648-PG4FP	97	<b>10</b>	10	No	423597	1.48
647QG32	126	<b>6</b>	6	Yes	416391	0.2042	648-PG5FP	97	5	5	No	423580	2.8758
647QG34	126	<b>6</b>	6	Yes	416407	0.2908	648-PG6FP	97	<b>1</b>	1	No	423573	3.9
647QG4	126	<b>12</b>	12	Yes	416414	0.3217	648-PG7FP	97	<b>1</b>	1	No	415271	5.52
647QG43	126	<b>6</b>	6	Yes	416421	0.2533	648QG2	129	<b>12</b>	12	Yes	416469	0.4208
647QG5	126	<b>3</b>	3	Yes	416438	0.7933	648QG3	129	<b>12</b>	12	Yes	416490	0.681
647QG6	126	<b>3</b>	3	Yes	416445	1.11	648QG4	129	<b>6</b>	6	Yes	416506	1.1542
647QG7	126	<b>3</b>	3	Yes	416452	1.5683	648VG2FP	72	<b>10</b>	10	No	412997	0.59
647QK0	718	<b>5</b>	60	Yes	681317	-	648VG3FP	72	<b>10</b>	10	No	413000	0.86
647QK10	718	<b>5</b>	60	Yes	681324	-	648VG4FP	72	<b>10</b>	10	No	413017	1.48
647WG2	52	<b>50</b>	50	No	409942	0.1391	648WG-2	57	<b>6</b>	108	Yes	406446	0.2986
647WG23	52	<b>50</b>	50	No	409959	0.1684	648WG2FPD	56	<b>10</b>	10	No	423054	0.5381
647WG2E3	52	<b>50</b>	50	No	416698	0.2	648WG2FPPK1	56	<b>10</b>	100	Yes	412362	0.2947
647WG3	52	<b>50</b>	50	No	409966	0.196	648WG-3	57	<b>6</b>	72	Yes	406552	0.4889
647WG32	52	<b>25</b>	25	No	409607	0.198	648-WG3CR	112	<b>6</b>	6	Yes	724458	-
647WG4	52	<b>25</b>	25	No	409980	0.4363	648WG3FPD	56	<b>6</b>	6	No	423115	0.925
647WG43	52	<b>25</b>	25	No	409997	0.386	648WG3FPPK1	56	<b>10</b>	100	Yes	412379	0.4334
647WG5	52	<b>5</b>	5	No	410016	0.5503	648-WG3HR	112	<b>6</b>	6	Yes	724465	0.9417
647WG6	52	<b>5</b>	5	No	410030	0.8236	648-WG3WR	112	<b>6</b>	6	Yes	724472	0.9583
647WG7	52	<b>5</b>	5	No	410535	1.6813	648WG3WRV	56	6	6	Yes	723659	0.9667
647X23E	22	<b>50</b>	50	No	482938	0.2462	648WG-4	57	<b>6</b>	36	Yes	406583	0.7611
647XG2	21	<b>50</b>	250	No	407092	0.0798	648WG4FPPK1	56	12	60	Yes	412348	0.7779
647XG21E3	22	<b>25</b>	25	No	445346	0.238	648WG5FP	56	<b>5</b>	5	No	415714	2.025

Supply

Drainage

Support

Specialties

Appendix

# Numerical Index

Supply

Drainage

Support

Specialties

Appendix

Item No	Page No	Min Qty	Case Qty	UPC Bar-Coded	UPC 6-Digit	Weight (lbs.)	Item No	Page No	Min Qty	Case Qty	UPC Bar-Coded	UPC 6-Digit	Weight (lbs.)
648WG6FP	56	<b>1</b>	1	No	415721	3.31	649Y4PK1	43	<b>10</b>	10	Yes	706508	0.2615
648WG7FP	56	<b>1</b>	1	No	415738	5.91	652-A	143	1	16	No	107527	0.609
648XG2	28	10	120	No	406866	0.2729	652-AC	143	1	16	No	106780	0.698
648XG2FA	612	<b>5</b>	60	No	202734	0.1662	652-AD	145	1	16	No	109668	0.652
648XG2PK	28	<b>10</b>	10	Yes	412966	0.232	652-AS	143	1	16	No	107022	0.6997
648XG3	28	8	96	No	406873	0.2896	652-AWG	144	1	16	No	423122	0.6232
648-XG3CR	112	<b>6</b>	6	Yes	724489	0.95	652-AX	144	1	16	No	430311	0.5645
648XG3FPD	28	<b>5</b>	30	No	445100	0.45	653-B	143	1	16	No	107534	0.7912
648-XG3HR	112	<b>6</b>	6	Yes	724496	-	653-BC	143	1	16	No	154101	0.8193
648XG3PK	28	<b>10</b>	10	Yes	412973	0.3235	653-BS	143	1	16	No	107053	0.8445
648-XG3XR	112	<b>6</b>	6	Yes	724502	0.9167	653-BWG	144	1	16	No	422798	0.8472
648XG3XRV	28	6	6	Yes	723642	0.9153	653-BX	144	1	16	No	430328	0.7294
648XG4	28	4	40	No	406880	0.6763	654-C	143	1	16	No	107541	1.03
648XG4PK	28	<b>6</b>	6	Yes	412980	0.7265	654-CC	143	1	16	No	154118	1.05
649TX2	17	<b>100</b>	1000	No	407603	0.0064	654-CS	143	1	16	No	107084	1.0344
649TX2	43	<b>100</b>	1000	No	407603	0.0064	654-CWG	144	1	16	No	423139	1.1031
649TX3	17	<b>100</b>	500	No	407948	0.0095	654-CX	144	1	16	No	404466	0.9941
649TX3	43	<b>100</b>	500	No	407948	0.0095	655-D	143	1	4	No	107558	2.0476
649TX4	17	<b>25</b>	250	No	407955	0.0174	655-DS	143	1	4	No	107114	2.1239
649TX4	43	<b>25</b>	250	No	407955	0.0174	656-E	143	1	4	No	107121	2.3756
649WP2	49	<b>50</b>	1000	No	729347	0.0072	656-ES	143	1	4	No	107145	2.4422
649WP2	63	<b>50</b>	1000	No	729347	0.0072	657-F	143	1	4	No	107152	2.7856
649WP3	49	<b>50</b>	500	No	729354	0.0129	657-FD	145	1	4	No	109675	2.7856
649WP3	63	<b>50</b>	500	No	729354	0.0129	657-FS	143	1	4	No	107176	2.9875
649WP4	49	<b>25</b>	250	No	729415	0.0238	658-1503	144	<b>1</b>	1	No	107268	17.11
649WP4	63	<b>25</b>	250	No	729415	0.0238	658-2002	144	<b>1</b>	1	No	107336	17.99
649WP5	49	<b>10</b>	10	No	710468	0.52	658-2004	144	<b>1</b>	1	No	107350	18.636
649WP5	63	<b>10</b>	10	No	710468	0.52	658-4004	144	<b>1</b>	1	No	107411	30.9261
649WP6	49	<b>10</b>	10	No	710475	-	658-4004F2	144	<b>1</b>	1	No	107435	32.6249
649WP6	63	<b>10</b>	10	No	710475	-	658S2002	144	<b>1</b>	1	No	107503	20.5
649WP7	49	<b>10</b>	10	No	710482	-	658S2004F2	144	<b>1</b>	1	No	107510	29.4572
649WP7	63	<b>10</b>	10	No	710482	-	658S4004F2	144	<b>1</b>	1	No	107565	41.3
649X1	17	<b>100</b>	1000	No	483522	0.0111	660-G2	141	<b>6</b>	6	Yes	154316	0.3821
649X1	43	<b>100</b>	1000	No	483522	0.0111	660-G2B	141	<b>50</b>	50	No	407832	0.143
649X2	17	<b>100</b>	1000	No	495327	0.0127	660-GTC0	142	<b>6</b>	6	Yes	415103	0.3625
649X2	43	<b>100</b>	1000	No	495327	0.0127	660-GTC0B	142	<b>25</b>	25	No	415110	0.2748
649X3	17	<b>100</b>	500	No	495334	0.0178	660-GTC1	142	<b>6</b>	6	Yes	415127	0.4575
649X3	43	<b>100</b>	500	No	495334	0.0178	660-GTC1B	142	<b>25</b>	25	No	415134	0.296
649X4	17	<b>25</b>	250	No	483645	0.024	660-GTR	142	<b>6</b>	6	Yes	154330	0.5917
649X4	43	<b>25</b>	250	No	483645	0.024	660-GTR0	142	<b>6</b>	6	Yes	415141	0.28
649X5	17	<b>25</b>	250	No	495457	0.0453	660-GTR0B	142	<b>25</b>	25	No	415158	0.28
649X6	17	<b>25</b>	250	No	495372	0.0786	660-GTR1	142	<b>6</b>	6	Yes	154347	0.5333
649X7	17	<b>10</b>	200	No	725646	-	660-GTR1B	142	<b>25</b>	25	No	407849	0.4452
649Y1PK1	17	1	200	Yes	706454	0.0625	660-GTRB	142	<b>25</b>	25	No	407856	0.5107
649Y1PK1	43	1	200	Yes	706454	0.0625	660-GTW2B	142	<b>25</b>	25	No	415790	0.3094
649Y2	17	1	20	Yes	706478	0.9675	660-GTX2	142	<b>6</b>	6	Yes	415165	0.468
649Y2	43	1	20	Yes	706478	0.9675	660-GTX2B	142	<b>25</b>	25	No	413123	0.416
649Y3	17	1	10	Yes	706492	1.57	660-GVPX2B	141	50	50	No	415196	0.31
649Y3	43	1	10	Yes	706492	1.57	660-H	141	<b>6</b>	6	Yes	106605	0.7005
649Y4PK1	17	<b>10</b>	10	Yes	706508	0.2615	660-HB	141	<b>25</b>	25	No	106070	0.396

Item No	Page No	Min Qty	Case Qty	UPC Bar-Coded	UPC 6-Digit	Weight (lbs.)	Item No	Page No	Min Qty	Case Qty	UPC Bar-Coded	UPC 6-Digit	Weight (lbs.)
660-HPK2	141	<b>20</b>	20	Yes	707925	0.8025	663-23834SS	135	<b>1</b>	1	No	711243	7.65
660-S	141	<b>6</b>	6	Yes	106773	0.3275	663-25810SS	135	<b>1</b>	1	No	711335	9.15
660-SB	141	<b>50</b>	50	No	106094	0.2409	663-25812SS	135	<b>1</b>	1	No	711175	7.85
660-TK	141	<b>6</b>	6	Yes	106162	0.55	663-25838SS	135	<b>1</b>	1	No	711076	7.95
660-TKB	141	<b>25</b>	25	No	106186	0.4873	663-31212SS	135	<b>1</b>	1	No	714763	7.75
660-TS	141	25	25	No	106230	0.2834	664X2B10	11	<b>1</b>	1	No	455390	28
660-TS8	141	25	25	No	106247	0.546	664X2B20	11	<b>1</b>	1	No	421425	55
660-TS88	141	25	25	No	106254	0.7332	664X2R10	11	<b>1</b>	1	No	455406	28
660-TSWG	141	<b>25</b>	25	No	462411	0.3519	664X2R20	11	<b>1</b>	1	No	421418	55
660-TSWG8	141	25	25	No	400093	0.59	664X2W10	11	<b>1</b>	1	No	455413	28
660-TSX	141	25	25	No	109835	0.4465	664X2W20	11	<b>1</b>	1	No	421432	55
660-TSX88	141	25	25	No	109828	0.7954	664X3B10	11	<b>1</b>	1	No	455420	26
660-V82B	141	<b>50</b>	50	No	490759	0.1614	664X3B20	11	<b>1</b>	1	No	421456	53
660-WG2B	141	<b>50</b>	50	No	406811	0.2257	664X3H20	12	<b>1</b>	1	No	439154	26
660-X2B	141	<b>50</b>	50	No	106315	0.1605	664X3R10	11	<b>1</b>	1	No	455437	26
663-05810HS	136	<b>1</b>	1	No	710925	7.65	664X3R20	11	<b>1</b>	1	No	421449	55
663-05810SS	135	<b>1</b>	1	No	711267	8.55	664X3W10	11	<b>1</b>	1	No	455444	26
663-05812HS	136	<b>1</b>	1	No	710758	8.15	664X3W20	11	<b>1</b>	1	No	421463	54
663-05812SS	135	<b>1</b>	1	No	711090	8.35	664X4B10	11	<b>1</b>	1	No	712035	26
663-05834SS	135	<b>1</b>	1	No	711182	10.7	664X4B20	11	<b>1</b>	1	No	421487	52
663-05838HS	135	<b>1</b>	1	No	710673	8.1	664X4H20	12	<b>1</b>	1	No	102874	18
663-05838SS	135	<b>1</b>	1	No	711014	9.4	664X4R10	11	<b>1</b>	1	No	712042	25.5
663-07810HS	136	<b>1</b>	1	No	710932	9.05	664X4R20	11	<b>1</b>	1	No	421470	51
663-07810SS	135	<b>1</b>	1	No	711274	9.55	664X4W10	11	<b>1</b>	1	No	102898	26.36
663-07812HS	136	<b>1</b>	1	No	710772	7.05	664X4W20	11	<b>1</b>	1	No	421494	51.9
663-07812SS	135	<b>1</b>	1	No	711113	10.15	664X5W20	11	<b>1</b>	1	No	421500	51.24
663-07834SS	135	<b>1</b>	1	No	711199	10.4	664X6W20	11	<b>1</b>	1	No	422231	59.1992
663-07838HS	135	<b>1</b>	1	No	710680	6.95	664X7W20	11	<b>1</b>	1	No	422248	3
663-07838SS	135	<b>1</b>	1	No	711021	7.3	664XA6W20	13	<b>1</b>	1	No	713544	56
663-11810HS	136	<b>1</b>	1	No	710949	9.2	664XA7W20	13	<b>1</b>	1	No	204769	60
663-11810SS	135	<b>1</b>	1	No	711281	9.85	665X0W100	11	<b>1</b>	1	Yes	444936	3
663-11812SS	135	<b>1</b>	1	No	711120	7.7	665X1W100	11	<b>1</b>	1	Yes	444929	4
663-11834SS	135	<b>1</b>	1	No	711205	8.7	665X2B100	11	<b>1</b>	1	Yes	421524	6
663-11838HS	135	<b>1</b>	1	No	710697	7.1	665X2B1000	12	<b>1</b>	1	Yes	421616	55
663-11838SS	135	<b>1</b>	1	No	711038	7.7	665X2B300	12	<b>1</b>	1	Yes	421555	16.5
663-13810SS	135	<b>1</b>	1	No	711298	10.2	665X2B500	12	<b>1</b>	1	Yes	421586	28
663-13812SS	135	<b>1</b>	1	No	711137	8.05	665X2H100	12	<b>1</b>	1	Yes	418074	6.29
663-13834SS	135	<b>1</b>	1	No	711212	9.45	665X2H1000	13	<b>1</b>	1	Yes	206411	54.892
663-13838HS	135	<b>1</b>	1	No	710703	7.4	665X2H1200	13	<b>1</b>	1	Yes	703842	64.15
663-13838SS	135	<b>1</b>	1	No	711045	7.8	665X2H300	13	<b>1</b>	1	Yes	102539	16.4676
663-15810SS	135	<b>1</b>	1	No	711304	9.9	665X2H500	13	<b>1</b>	1	Yes	458261	27.446
663-15812SS	135	<b>1</b>	1	No	711144	8.2	665X2R100	11	<b>1</b>	1	Yes	421517	6
663-15834SS	135	<b>1</b>	1	No	711229	10	665X2R1000	12	<b>1</b>	1	Yes	421609	55
663-15838SS	135	<b>1</b>	1	No	711052	7.8	665X2R300	12	<b>1</b>	1	Yes	421548	16.5
663-21810SS	135	<b>1</b>	1	No	711311	9.8	665X2R500	12	<b>1</b>	1	Yes	421579	28
663-21812SS	135	<b>1</b>	1	No	711151	7.9	665X2W100	11	<b>1</b>	1	Yes	421531	6
663-21834SS	135	<b>1</b>	1	No	711236	8.55	665X2W1000	12	<b>1</b>	1	Yes	421623	55
663-21838SS	135	<b>1</b>	1	No	711069	6.7	665X2W300	12	<b>1</b>	1	Yes	421562	16.5
663-23810SS	135	<b>1</b>	1	No	711328	9.85	665X2W500	12	<b>1</b>	1	Yes	421593	28
663-23812SS	135	<b>1</b>	1	No	711168	7.75	665X3B100	11	<b>1</b>	1	Yes	421647	11

Supply

Drainage

Support

Specialties

Appendix

# Numerical Index

Supply

Drainage

Support

Specialties

Appendix

Item No	Page No	Min Qty	Case Qty	UPC Bar-Coded	UPC 6-Digit	Weight (lbs.)	Item No	Page No	Min Qty	Case Qty	UPC Bar-Coded	UPC 6-Digit	Weight (lbs.)
665X3B300	12	1	1	Yes	421678	31.99	672WG0440	61	1	10	Yes	407337	0.844
665X3B500	12	1	1	Yes	421708	53	672WG0490	60	10	10	Yes	429551	0.416
665X3H100	12	1	1	Yes	418081	13.9	672WG0499	60	10	10	Yes	457189	1.245
665X3H300	13	1	1	Yes	443366	31.5	672WG04C0	61	10	10	Yes	412294	1.2053
665X3H500	13	1	1	Yes	703262	51	672WG0630	60	1	10	Yes	411938	1.5376
665X3R100	11	1	1	Yes	421630	11	672WG0640	61	1	10	Yes	407368	1.074
665X3R300	12	1	1	Yes	421661	31.99	672WG0690	60	10	10	Yes	457196	1.36
665X3R500	12	1	1	Yes	421692	53	672WG0699	60	10	10	Yes	457219	1.565
665X3W100	11	1	1	Yes	421654	11.9	672WG06C0	61	10	10	Yes	412287	1.3748
665X3W300	12	1	1	Yes	421685	32.99	672WG0830	60	1	10	Yes	411884	2.0439
665X3W500	12	1	1	Yes	421715	53	672WG0840	61	1	10	Yes	407375	2.0465
665X4B100	11	1	1	Yes	421739	17.2	672WG0890	60	10	10	Yes	457226	1.515
665X4B300	12	1	1	Yes	421760	51.6	672WG0899	60	10	10	Yes	457233	1.89
665X4B500	12	1	1	Yes	421791	86	672WG08C0	61	10	10	Yes	412270	2.1491
665X4H100	12	1	1	Yes	455130	19.0225	672WG1040	61	1	10	Yes	407382	1.69
665X4H300	13	1	1	Yes	703750	-	672WG1240	61	1	10	Yes	407399	2.006
665X4H500	13	1	1	Yes	444394	86	672WGT0390	62	10	100	Yes	443977	0.01
665X4R100	11	1	1	Yes	421722	17.2	672WGT0399	62	10	100	Yes	456595	0.475
665X4R300	12	1	1	Yes	421753	51.6	672WGT0490	62	10	100	Yes	458247	0.451
665X4R500	12	1	1	Yes	421784	86	672WGT0499	62	10	100	Yes	458254	0.495
665X4W100	11	1	1	Yes	421746	17.2	672WP0290	66	10	50	Yes	710499	-
665X4W300	12	1	1	Yes	421777	51.6	672WP0299	66	10	140	Yes	710505	0.0661
665X4W500	12	1	1	Yes	421807	84	672WP0390	66	10	140	Yes	710512	-
665X5W100	11	1	1	Yes	455635	25	672WP0399	66	10	140	Yes	710529	0.0882
665X5W300	12	1	1	Yes	463128	75	672WP0470	66	10	100	Yes	715265	-
665X6W100	11	1	1	Yes	457264	37	672WP0477	66	10	100	Yes	715272	-
665X6W300	12	1	1	Yes	455642	106.2	672WP0490	66	10	100	Yes	710536	0.111
665X8W100	11	1	1	Yes	457462	5.5	672WP0499	66	10	100	Yes	710543	0.111
665X9H100	12	1	1	Yes	703767	8.1	672WP0670	66	10	60	Yes	715289	-
665X9H1000	13	1	1	Yes	444486	76.8	672WP0677	66	10	60	Yes	715296	-
665X9H300	13	1	1	Yes	703774	24.2	672WP0690	66	10	60	Yes	710550	0.1542
665X9H500	13	1	1	Yes	703552	39.7325	672WP0699	66	10	60	Yes	710567	0.1683
665XA2N100	13	1	1	Yes	417671	6	672WPT0399	66	10	10	Yes	715302	0.1075
665XA2N1000H	14	1	1	Yes	205230	56.1	672WPT0499	66	10	10	Yes	715319	0.095
665XA2N250	13	1	1	Yes	417701	26.5152	672WPT0699	66	10	10	Yes	715326	0.1392
665XA2N300H	14	1	1	Yes	410436	18	672WV0230	60	1	10	Yes	407726	1.1797
665XA2N500	13	1	1	Yes	417763	53.0303	672WV0330	60	1	10	Yes	407719	1.694
665XA3N100	13	1	1	Yes	417688	11	672WV0430	60	1	10	Yes	407702	2.8388
665XA3N250	13	1	1	Yes	417725	27.5	672WV0444	61	1	10	Yes	411211	1.67
665XA4N100	13	1	1	Yes	417695	17.5	672WV0630	60	1	10	Yes	407696	2.9185
672Q0490	131	10	10	Yes	410696	1.186	672WV0644	61	1	10	Yes	411228	2.36
672Q0499	131	10	10	Yes	410719	1.295	672WV0830	60	1	10	Yes	407689	5.1138
672Q0590	131	10	10	Yes	410702	1.417	672WV0844	61	1	10	Yes	411235	3.551
672Q0599	131	10	10	Yes	410726	1.583	672WV1030	60	1	10	Yes	407672	4.47
672Q0690	131	10	10	Yes	410689	1.6105	672WV1044	61	1	10	Yes	411242	4.6911
672Q0699	131	10	10	Yes	410733	1.737	672WV1230	60	1	4	Yes	407429	5.176
672WG0240	61	1	10	Yes	407412	0.461	672X0242	36	1	10	Yes	499653	0.639
672WG0340	61	1	10	Yes	407405	0.6952	672X0330	34	25	25	No	400772	0.6592
672WG03C0	61	10	10	Yes	412300	1.033	672X0342	36	1	10	Yes	499660	0.8061
672WG0430	60	1	10	Yes	412874	1.1217	672X0380	33	25	25	No	457431	0.57

Item No	Page No	Min Qty	Case Qty	UPC Bar-Coded	UPC 6-Digit	Weight (lbs.)	Item No	Page No	Min Qty	Case Qty	UPC Bar-Coded	UPC 6-Digit	Weight (lbs.)
672X0390	32	25	25	No	405050	0.5211	<b>672X10C0</b>	37	10	10	No	498847	1.6374
<b>672X0390PK</b>	32	<b>5</b>	5	Yes	402011	0.5714	<b>672X1230</b>	34	25	25	No	405296	1.7731
672X0399	32	25	25	No	405067	0.5209	<b>672X1233EE</b>	35	10	10	No	405302	3.0547
<b>672X03C0</b>	37	10	10	No	499561	0.7305	<b>672X1240</b>	35	25	25	No	405319	1.7731
672X0430	34	25	25	No	405074	0.7324	<b>672X1244</b>	35	25	25	No	406132	1.9955
<b>672X0431PK</b>	34	<b>5</b>	5	Yes	480729	1.078	<b>672X1270</b>	33	10	10	No	497918	1.7832
<b>672X0433EE</b>	35	10	10	No	405081	1.1682	<b>672X1277</b>	34	10	10	No	497901	1.8036
<b>672X0440</b>	35	25	25	No	406071	0.8368	<b>672X1290</b>	32	25	25	No	480460	1.588
<b>672X0442</b>	36	1	10	Yes	499677	0.9478	<b>672X1297</b>	33	10	10	No	498427	1.7832
<b>672X0470</b>	33	10	10	No	498175	0.7003	<b>672X1299</b>	32	25	25	No	480224	1.576
<b>672X0477</b>	34	10	10	No	497826	0.7003	<b>672X12C0</b>	37	10	10	No	498540	1.902
<b>672X0480</b>	33	25	25	No	457424	0.626	<b>672X4L-1131B3</b>	36	5	5	Yes	405340	3.813
<b>672X0490</b>	32	25	25	No	480323	0.6448	<b>672XB0242</b>	36	1	10	Yes	499684	1.6998
<b>672X0490PK</b>	32	<b>5</b>	5	Yes	402059	0.6951	<b>672XB0342</b>	36	1	10	Yes	499691	2.4035
<b>672X0497</b>	33	10	10	No	497819	0.7003	<b>672XB0442</b>	36	1	10	Yes	499707	3.0666
<b>672X0499</b>	32	25	25	No	480125	0.6448	<b>672XGT0390</b>	37	<b>10</b>	100	Yes	442499	0.01
<b>672X0499PK</b>	32	<b>6</b>	6	Yes	420602	0.885	<b>672XGT0399</b>	37	<b>10</b>	100	Yes	443694	0.0255
<b>672X04C0</b>	37	10	10	No	499233	0.8368	<b>672XGT0490</b>	37	<b>10</b>	100	Yes	442888	0.25
<b>672X0590</b>	32	25	25	No	405128	0.8035	<b>672XGT0499</b>	37	<b>10</b>	100	Yes	443380	0.01
<b>672X0599</b>	32	25	25	No	405135	0.7935	<b>672XV0242</b>	36	1	10	Yes	499714	1.1199
<b>672X05C0</b>	37	10	10	No	499219	0.9398	<b>672XV0342</b>	36	1	10	Yes	499721	1.5234
<b>672X0630</b>	34	25	25	No	405142	1.0048	<b>672XV0431PK</b>	36	5	5	Yes	480835	1.8586
<b>672X0633EE</b>	35	10	10	No	405159	1.4066	<b>672XV0442</b>	36	1	10	Yes	499738	2.0055
<b>672X0640</b>	35	25	25	No	406095	0.976	<b>672XV0486PK</b>	34	5	5	Yes	700650	1.41
<b>672X0644</b>	35	25	25	No	406101	1.2257	<b>672XV0490</b>	32	1	10	Yes	405357	1.64
<b>672X0670</b>	33	10	10	No	497987	0.9464	<b>672XV0490PK</b>	32	<b>5</b>	5	Yes	401670	1.9397
<b>672X0677</b>	34	10	10	No	497833	0.9418	<b>672XV0499</b>	32	1	10	Yes	405364	2.1978
<b>672X0690</b>	32	25	25	No	480361	0.8958	<b>672XV0590</b>	32	1	10	Yes	405371	2.5752
<b>672X0690PK</b>	32	<b>5</b>	5	Yes	402073	0.9876	<b>672XV0599</b>	32	1	10	Yes	405388	2.05
<b>672X0697</b>	33	10	10	No	497802	0.9464	<b>672XV0690</b>	32	1	10	Yes	405395	2.9734
<b>672X0698</b>	33	25	25	No	457417	0.92	<b>672XV0699</b>	32	1	10	Yes	405401	3.1922
<b>672X0699</b>	32	25	25	No	405180	0.8958	<b>672XV0699-2PK</b>	32	5	5	Yes	480170	2.778
<b>672X0699PK</b>	32	<b>6</b>	6	Yes	480163	0.974	<b>672XV0810</b>	36	1	10	Yes	405418	3.408
<b>672X06C0</b>	37	10	10	No	499127	1.0665	<b>672XV0810L</b>	36	1	10	Yes	441737	3.9482
<b>672X0790</b>	32	25	25	No	405197	0.788	<b>672XV1010</b>	36	1	10	Yes	405425	4.7564
<b>672X0830</b>	34	25	25	No	405203	1.2822	<b>672XV1010L</b>	36	1	10	Yes	441744	4.7564
<b>672X0833EE</b>	35	10	10	No	405210	1.7579	<b>672XV1210</b>	36	1	4	Yes	405432	6.0507
<b>672X0840</b>	35	25	25	No	406118	1.3394	<b>672XV1210L</b>	36	1	4	Yes	441751	6.1478
<b>672X0844</b>	35	25	25	No	406125	1.4826	<b>672XV1510</b>	36	1	5	Yes	405449	7.3391
<b>672X0870</b>	33	10	10	No	497932	1.1901	<b>672XV1510L</b>	36	1	5	Yes	441768	7.3824
<b>672X0877</b>	34	10	10	No	497864	1.2691	<b>672XV1810</b>	36	1	5	Yes	405456	8.5368
<b>672X0890</b>	32	25	25	No	405227	1.1901	<b>672XV1810L</b>	36	1	5	Yes	441775	8.5368
<b>672X0897</b>	33	10	10	No	497765	1.1901	<b>672XV4L-11313</b>	36	1	5	Yes	405463	6.1294
<b>672X0899</b>	32	25	25	No	480187	1.1901	<b>675-20442</b>	117	10	10	No	499769	1.1545
<b>672X08C0</b>	37	10	10	No	498830	1.3773	<b>675-20544</b>	117	10	10	No	405500	1.1232
<b>672X0930</b>	34	25	25	No	405241	1.4109	<b>675-V20244</b>	118	1	10	Yes	405517	1.1597
<b>672X0990</b>	32	25	25	No	405258	1.2998	<b>675-V20344</b>	118	1	10	Yes	405524	1.9628
<b>672X0999</b>	32	25	25	No	405265	1.2998	<b>675-V20442</b>	118	1	10	Yes	499479	2.0393
<b>672X1033EE</b>	35	10	10	No	405272	2.0149	<b>675-V20544</b>	118	1	10	Yes	405548	1.179
<b>672X1090</b>	32	25	25	No	405289	1.4285	<b>67745L-08334</b>	117	1	5	Yes	405555	4.6767

Supply

Drainage

Support

Specialties

Appendix

# Numerical Index

Supply

Drainage

Support

Specialties

Appendix

Item No	Page No	Min Qty	Case Qty	UPC Bar-Coded	UPC 6-Digit	Weight (lbs.)	Item No	Page No	Min Qty	Case Qty	UPC Bar-Coded	UPC 6-Digit	Weight (lbs.)
678-20242	116	10	10	Yes	405562	0.4528	687-3QV	199	<b>8</b>	8	Yes	713049	-
678-20342	116	10	10	Yes	405579	0.567	687-3RPQ	191	1	9	Yes	712844	-
678-20344	116	10	10	Yes	405586	0.5374	687-3RPQD	191	1	9	Yes	712769	-
678-20442	116	10	10	Yes	405593	0.708	687-3RQQ	191	1	9	Yes	712868	-
678-20644	116	10	10	Yes	405609	0.975	687-3RQQD	191	1	9	Yes	712783	-
678-21244	116	10	10	No	405616	1.719	687-3RWW	191	1	9	Yes	712905	-
6784L-11313	116	5	5	Yes	405623	3.1345	687-3RWW D	191	1	9	Yes	712820	-
6795L-12333	116	1	5	Yes	405630	4.6994	687-3RXX	191	1	9	Yes	712882	-
6796L-12333	116	1	5	Yes	405647	5.6333	687-3RXXD	191	1	9	Yes	712806	4.0278
6797L-12333	117	1	4	Yes	405654	7.24	687-3SFMH	110	5	5	Yes	735713	-
685-C2	81	<b>20</b>	20	No	497185	0.1073	687-3SMFH	110	<b>5</b>	5	Yes	713087	-
685-C3	81	<b>20</b>	20	No	496928	0.1634	687-3SMKIT	110	<b>5</b>	5	Yes	713100	-
685-C4	81	<b>20</b>	20	No	497024	0.2545	687-3SMKIT2	110	<b>5</b>	5	No	736802	-
685-C5	81	<b>10</b>	10	No	497079	0.5275	687-3SMMH	110	<b>5</b>	5	Yes	713094	-
685-C6	81	<b>5</b>	5	No	497758	0.6591	687-3SQD	183	1	9	Yes	712691	-
685-C7	81	<b>5</b>	5	No	497314	1.0472	687-3WD	183	1	9	Yes	712585	3.25
685-P3	96	<b>20</b>	20	No	497734	0.175	687-3WDT	187	1	9	Yes	712462	4.3077
685-P4	96	<b>20</b>	20	No	497628	0.2625	687-3WH	195	1	6	Yes	712929	5.8083
685-P5	96	<b>10</b>	10	No	497512	0.5442	687-3WH2	195	1	6	Yes	712974	5.4
685-P6	96	<b>5</b>	5	No	497383	0.6743	687-3WV	199	<b>8</b>	8	Yes	713025	-
685-P7	96	<b>5</b>	5	No	410467	1.0218	687-3XD	183	1	9	Yes	712622	1.46
687-1F	216	<b>10</b>	10	No	737564	0.1418	687-3XDT	187	1	9	Yes	712486	-
687-2CD	183	1	9	Yes	712653	-	687-3XH	195	1	6	Yes	712936	-
687-2PD	183	1	9	Yes	712530	-	687-3XH2	195	1	6	Yes	712981	-
687-2QD	183	1	9	Yes	712493	-	687-3XV	199	<b>8</b>	8	Yes	713032	-
687-2QDT	187	1	9	Yes	712431	-	687-442QB	203	6	6	Yes	737083	-
687-2WD	183	1	9	Yes	712578	-	687-442WB	203	6	6	Yes	737090	-
687-2WDT	187	1	9	Yes	712455	3.6528	687-442XB	203	6	6	Yes	737106	-
687-2XD	183	1	9	Yes	712615	2.95	687-4CD	183	1	9	Yes	712677	-
687-2XDT	187	1	9	Yes	712479	-	687-4CWD	183	1	9	Yes	712721	-
687-332CB	203	8	8	Yes	713148	-	687-4CXD	183	1	9	Yes	712738	-
687-332MB	203	8	8	Yes	713155	-	687-4PD	183	1	9	Yes	712554	-
687-332QB	203	8	8	Yes	713131	-	687-4QD	183	1	9	Yes	712516	-
687-332WB	203	8	8	Yes	713117	-	687-4RPQ	191	1	9	Yes	712851	-
687-332XB	203	8	8	Yes	713124	-	687-4RPQD	191	1	9	Yes	712776	-
687-3CD	183	1	9	Yes	712660	-	687-4RQQ	191	1	9	Yes	712875	-
687-3CH	195	1	6	Yes	712950	-	687-4RQQD	191	1	9	Yes	712790	-
687-3CH2	195	1	6	Yes	713001	-	687-4RWW	191	1	9	Yes	712912	-
687-3CV	199	<b>8</b>	8	Yes	713056	-	687-4RWW D	191	1	9	Yes	712837	4.25
687-3CVKIT	110	1	400	Yes	736994	-	687-4RXX	191	1	9	Yes	712899	-
687-3CWD	183	1	9	Yes	712745	-	687-4RXXD	191	1	9	Yes	712813	-
687-3CXD	183	1	9	Yes	712752	-	687-4SQD	183	1	9	Yes	712707	-
687-3PD	183	1	9	Yes	712547	-	687-4WD	183	1	9	Yes	712592	3.65
687-3PH	195	1	6	Yes	712967	-	687-4XD	183	1	9	Yes	712639	3.7111
687-3PH2	195	1	6	Yes	713018	-	687-5CD	183	1	9	Yes	712684	-
687-3PV	199	<b>8</b>	8	Yes	713063	-	687-5PD	183	1	9	Yes	712561	-
687-3QD	183	1	9	Yes	712509	-	687-5QD	183	1	9	Yes	712523	-
687-3QDT	187	1	9	Yes	712448	-	687-5WD	183	1	9	Yes	712608	-
687-3QH	195	1	6	Yes	712943	-	687-5XD	183	1	9	Yes	712646	-
687-3QH2	195	1	6	Yes	712998	-	687-PVLV	110	<b>5</b>	5	Yes	742537	192.94



Item No	Page No	Min Qty	Case Qty	UPC Bar-Coded	UPC 6-Digit	Weight (lbs.)	Item No	Page No	Min Qty	Case Qty	UPC Bar-Coded	UPC 6-Digit	Weight (lbs.)
687-T3MMS	110	5	5	No	742391	0.32	694CG33012091	87	10	10	Yes	412171	2.617
687-T3MSM	110	5	5	No	742407	1.35	694CG33012093	87	10	10	Yes	412188	2.486
687-T3MSS	110	5	5	No	742414	1.5	694CG331220	87	10	10	Yes	412317	2.1997
688-1	215	10	10	No	100993	0.71	694CG36012092	87	10	10	Yes	415783	3.1222
688-C0B	216	1	10	Yes	713537	0.06	694-G21012091	119	1	10	Yes	413369	1.4818
688-C0B	678	1	10	Yes	713537	0.06	694Q312620	130	10	10	Yes	421913	1.3847
688-C1B	216	1	4	Yes	456458	0.2	694Q464120	130	10	10	Yes	421920	16.9
688-C1B	678	1	4	Yes	456458	0.2	694WG71022091	59	10	10	Yes	410245	1.8186
688-F	216	10	10	No	101686	0.19	694XG32012091	31	10	10	Yes	406675	2.7754
688-G10CR	161	10	10	Yes	712226	7.75	694XG32012093	31	10	10	Yes	413079	2.385
688-G10MR	161	10	10	Yes	712233	1.605	694XG322120	31	10	10	Yes	413062	2.3152
688-G10PR	161	10	10	Yes	714732	-	695-01	149	1	24	Yes	109002	1.3595
688-G10VR	161	10	10	Yes	714756	1.5	695-2A	150	1	10	Yes	309280	0.3694
688-G10WR	161	10	10	Yes	102966	1.635	695-2A	351	1	10	Yes	309280	0.3694
688-G10XR	161	10	10	Yes	103000	1.63	695-2P	150	1	10	Yes	309297	0.4654
688-G11CR	161	10	10	Yes	712240	1.75	695-2P	351	1	10	Yes	309297	0.4654
688-G11MR	161	10	10	Yes	712257	-	695-3A	150	1	10	No	309303	0.695
688-G11PR	161	10	10	Yes	714749	1.845	695-3A	351	1	10	No	309303	0.695
688-G11VR	161	10	10	Yes	714817	1.65	695-3P	150	1	10	Yes	309310	0.873
688-G11WR	161	10	10	Yes	103086	1.84	695-3P	351	1	10	Yes	309310	0.873
688-G11XR	161	10	10	Yes	103109	1.523	695-4A	150	1	10	No	309327	0.9508
688-G1CE	215	10	10	Yes	700803	0.365	695-4A	351	1	10	No	309327	0.9508
689C0101	87	12	12	Yes	481603	0.8471	695-4P	150	1	10	Yes	309334	1.3308
689C0111	87	12	12	Yes	481559	1.0333	695-4P	351	1	10	Yes	309334	1.3308
689C1102	87	12	12	Yes	481566	1.1905	695-D20	149	1	16	Yes	109019	0.4031
689C1112	87	12	12	Yes	481610	1.3558	695-D30	149	1	16	Yes	109026	0.7493
689VG3212	73	12	12	Yes	413185	1.3769	695-D40	149	1	16	Yes	109033	0.4875
689WG11	58	10	10	No	738820	9.7	695-D432	149	1	16	Yes	109040	0.4628
689WG201	58	10	10	No	738837	-	695-D4325	149	1	16	Yes	109057	0.4812
689WG211	58	10	10	No	738844	-	695-D432F	149	1	10	Yes	105042	0.8392
689WG2201	58	12	12	Yes	408327	0.812	695-ER05	151	1	1	Yes	412577	9.78
689WG2211	58	12	12	Yes	408334	1.0218	695-ER10	151	1	1	Yes	412584	11.56
689WG2291	58	12	12	Yes	408341	0.7496	695-ER15	151	1	1	Yes	412591	16.34
689WG3202	58	12	12	Yes	408358	1.2634	695-ER20	151	1	1	Yes	412607	17.62
689WG3212	58	12	12	Yes	408365	1.4207	695-ER30	151	1	1	Yes	412614	19.18
689WG5103	59	12	12	Yes	408426	1.8165	695-ES01	151	1	1	Yes	412676	3
689X2101	30	12	12	Yes	481658	0.6917	695-ES05	150	1	1	Yes	412621	7.23
689X2201	30	12	12	Yes	481672	0.8454	695-ES10	150	1	1	Yes	412638	8.76
689X2291	31	12	12	Yes	401953	0.7113	695-ES15	150	1	1	Yes	412645	9.54
689X3102	30	12	12	Yes	483652	0.935	695-ES20	150	1	1	Yes	412652	10.82
689X3112	30	12	12	Yes	481993	1.2398	695-ES30	150	1	1	Yes	412669	12.38
689X3202	30	12	12	Yes	481986	1.01	695-Y52	149	1	10	Yes	109064	0.4941
689X3212	30	12	12	Yes	481979	1.3162	696-1	215	10	10	No	109071	0.385
689X5103	30	12	12	Yes	481962	1.5278	696-1020GF	207	6	6	Yes	154354	1.35
689XG11	30	10	10	No	738578	-	696-1021GF	207	6	6	Yes	154361	1.6133
689XG201	30	10	10	No	738769	-	696-1031GF	207	6	6	Yes	154378	2.0083
689XG211	30	10	10	No	738790	-	696-11A	211	1	6	Yes	100665	0.7583
692-1308	112	25	25	No	405807	0.602	696-11A	458	1	6	Yes	100665	0.7583
693-13155301	119	12	12	Yes	495488	3.3162	696-11P	211	6	6	Yes	100672	0.9167
693-13755301	119	1	12	Yes	411310	3.2962	696-11P	457	6	6	Yes	100672	0.9167

Supply

Drainage

Support

Specialties

Appendix

# Numerical Index

Supply

Drainage

Support

Specialties

Appendix

Item No	Page No	Min Qty	Case Qty	UPC Bar-Coded	UPC 6-Digit	Weight (lbs.)	Item No	Page No	Min Qty	Case Qty	UPC Bar-Coded	UPC 6-Digit	Weight (lbs.)
696-12A	211	1	6	Yes	100689	0.775	696-G1001PF	169	10	10	Yes	702883	0.985
696-12A	458	1	6	Yes	100689	0.775	696-G1001VF	169	10	10	Yes	101815	-
696-12P	211	<b>6</b>	6	Yes	100696	0.875	696-G1001WF	169	10	10	Yes	100061	1
696-12P	457	<b>6</b>	6	Yes	100696	0.875	696-G1001WR	169	10	10	Yes	101549	0.99
696-1F	216	<b>10</b>	10	No	109323	0.1418	696-G1001XF	169	10	10	Yes	100078	0.985
696-1F	458	<b>10</b>	10	No	109323	0.1418	696-G1001XR	169	10	10	Yes	101532	0.965
696-2	215	<b>10</b>	10	No	109330	0.4211	696-G1010CF	165	10	10	Yes	100085	1.055
696-2313CF	157	10	10	Yes	109484	2.36	696-G1010CR	165	10	10	Yes	700094	1.005
696-2313CR	157	10	10	Yes	109491	2.335	696-G1010MF	165	10	10	Yes	100092	1.4032
696-2313ER	157	10	10	Yes	728920	2.475	696-G1010MR	165	10	10	Yes	412331	1.3184
696-2313MF	157	10	10	Yes	109521	2.784	696-G1010PF	165	10	30	Yes	101945	1.327
696-2313MFPK4	157	4	4	Yes	153951	3.3789	696-G1010PR	165	<b>10</b>	10	Yes	708755	0.99
696-2313MR	157	10	10	Yes	109538	2.6624	696-G1010VF	165	10	10	Yes	101648	1.327
696-2313VF	157	10	10	Yes	154194	2.465	696-G1010VR	165	10	10	Yes	102751	0.9
696-2313WF	157	10	10	Yes	109545	2.8	696-G1010WF	165	10	10	Yes	100115	1.392
696-2313WR	157	10	10	Yes	109552	2.39	696-G1010WR	165	10	10	Yes	101310	1.045
696-2313XF	157	10	10	Yes	109569	2.485	696-G1010XF	165	10	10	Yes	100122	1.3042
696-2313XR	157	10	10	Yes	109576	2.395	696-G1010XFS	165	10	10	Yes	101259	1.629
696-2413CF	159	10	10	Yes	410634	1.7	696-G1010XR	165	10	10	Yes	412430	1.07
696-2413MF	159	10	10	Yes	101099	1.75	696-G1011CF	169	10	10	Yes	100139	1.358
696-2413WF	159	10	10	Yes	101105	1.695	696-G1011MF	169	10	10	Yes	100146	1.23
696-2413XF	159	10	10	Yes	410641	1.7	696-G1011PF	169	10	30	Yes	102775	-
696-2F	216	<b>10</b>	10	No	109583	0.2495	696-G1011VF	169	10	10	Yes	102126	-
696-3	215	<b>10</b>	10	No	109590	0.4529	696-G1011WF	169	10	10	Yes	100153	0.8687
696-3F	215	<b>10</b>	10	No	109132	0.51	696-G1011XF	169	10	10	Yes	100160	0.7887
696-4	215	<b>10</b>	10	No	101051	0.3944	696-G2001CF	173	10	10	Yes	100177	1.7349
696-5	215	<b>10</b>	10	No	154415	0.4142	696-G2001CR	173	10	10	Yes	101464	1.6295
696-6	215	<b>10</b>	10	No	154422	0.365	696-G2001MF	173	10	10	Yes	100184	1.8442
696-7	215	<b>10</b>	10	No	154439	0.365	696-G2001MR	173	10	10	Yes	101525	1.6864
696-7	458	<b>10</b>	10	No	154439	0.365	696-G2001PF	173	10	10	Yes	702753	1.34
696-BC	216	<b>10</b>	10	No	109606	0.2785	696-G2001PR	173	<b>10</b>	10	Yes	708915	1.235
696-C3	216	<b>10</b>	10	Yes	154262	0.1574	696-G2001VF	173	10	10	Yes	101839	1.7474
696-CF	216	<b>10</b>	10	Yes	109972	0.1882	696-G2001WF	173	10	10	Yes	100191	1.27
696-EX	216	<b>10</b>	10	No	110312	0.0987	696-G2001WR	173	10	10	Yes	101518	1.265
696-G1000CF	165	10	10	Yes	100009	0.855	696-G2001XF	173	10	10	Yes	100207	1.821
696-G1000CR	165	10	10	Yes	412409	1.13	696-G2001XR	173	10	10	Yes	101501	1.6008
696-G1000MF	165	10	10	Yes	100016	1.105	696-G2011CF	173	10	10	Yes	100214	2.0704
696-G1000MFPK4	165	5	5	Yes	137128	1.2	696-G2011MF	173	10	10	Yes	100221	2.2866
696-G1000MR	165	10	10	Yes	412416	1.2001	696-G2011VF	173	10	10	Yes	101181	-
696-G1000PF	165	10	10	Yes	702654	-	696-G2011WF	173	10	10	Yes	100238	1.655
696-G1000VF	165	10	10	Yes	101594	1.0895	696-G2011XF	173	10	10	Yes	100245	1.705
696-G1000WF	165	10	10	Yes	100023	1.3	696-G2303CF	157	10	10	Yes	100252	2.145
696-G1000WR	165	10	10	Yes	101334	0.855	696-G2303CR	158	10	10	Yes	101471	1.935
696-G1000XF	165	10	10	Yes	100030	0.6276	696-G2303ER	158	10	10	Yes	734099	2.27
696-G1000XFS	165	10	10	Yes	101242	1.4705	696-G2303MF	157	10	10	Yes	100276	2.295
696-G1000XR	165	10	10	Yes	412423	0.925	696-G2303MR	158	10	10	Yes	102102	2.22
696-G1001CF	169	10	10	Yes	100047	1.2294	696-G2303PF	157	10	10	Yes	702760	2.15
696-G1001CR	169	10	10	Yes	101457	1.1422	696-G2303PR	158	<b>1</b>	10	Yes	734105	2.17
696-G1001MF	169	10	10	Yes	100054	1.095	696-G2303VF	157	10	10	Yes	101600	2.3355
696-G1001MR	169	10	10	Yes	101556	0.91	696-G2303VR	158	<b>10</b>	10	Yes	734112	2.05

Item No	Page No	Min Qty	Case Qty	UPC Bar-Coded	UPC 6-Digit	Weight (lbs.)	Item No	Page No	Min Qty	Case Qty	UPC Bar-Coded	UPC 6-Digit	Weight (lbs.)
696-G2303WF	157	10	10	Yes	100290	2.275	696-G4024CR	180	10	10	Yes	702531	-
696-G2303WR	158	10	10	Yes	102065	2.03	696-G4024MR	180	10	30	Yes	702890	-
696-G2303XF	157	10	10	Yes	100306	2.265	696-G4024PR	180	10	30	Yes	702616	-
696-G2303XR	158	10	10	Yes	102010	2	696-G4024WR	180	10	30	Yes	702906	-
696-G2313CF	157	10	10	Yes	100320	2.37	696-G4024XR	180	10	30	Yes	702630	-
696-G2313CR	157	10	10	Yes	700100	2.3	696-LC	216	<b>10</b>	10	No	153470	0.095
696-G2313ER	157	<b>10</b>	10	Yes	734129	2.485	696-LC	458	<b>10</b>	10	No	153470	0.095
696-G2313MF	157	10	10	Yes	100344	2.37	696-PN	216	<b>50</b>	50	No	109798	0.0092
696-G2313MR	157	<b>10</b>	10	Yes	734136	2.3	696R1020GF	207	10	10	Yes	154385	1.365
696-G2313PF	157	10	10	Yes	102362	-	696R1021GF	207	10	10	Yes	154392	1.77
696-G2313PR	157	<b>10</b>	10	Yes	708762	2.22	696R1031GF	207	10	10	Yes	154408	2.04
696-G2313VF	157	10	10	Yes	101662	2.635	696R2313CF	158	10	10	Yes	110268	2.455
696-G2313VR	157	10	10	Yes	102768	-	696R2313MF	158	10	10	Yes	110282	2.87
696-G2313WF	157	10	10	Yes	100368	2.505	696R2313VF	158	10	10	Yes	700001	2.82
696-G2313WR	157	10	10	Yes	102041	2.295	696R2313WF	158	10	10	Yes	110299	2.86
696-G2313XF	157	10	10	Yes	100375	2.545	696R2313XF	158	10	10	Yes	110305	2.8
696-G2313XR	157	10	10	Yes	734655	2.385	696R3	215	10	10	Yes	153500	0.795
696-G2403CF	159	10	10	Yes	101969	1.245	696RG1000CF	166	10	10	Yes	100399	1.24
696-G2403MF	159	10	10	Yes	101976	1.5	696RG1000MF	166	10	10	Yes	100405	1.255
696-G2403WF	159	10	10	Yes	101983	1.48	696RG1000VF	166	10	10	Yes	101624	1.265
696-G2403XF	159	10	10	Yes	700162	1.44	696RG1000WF	166	10	10	Yes	100412	1.11
696-G2413CF	159	10	30	Yes	103475	-	696RG1000XF	166	10	10	Yes	100429	1.125
696-G2413MF	159	<b>10</b>	10	Yes	103147	1.68	696RG1001CF	170	10	10	Yes	100436	1.3946
696-G2413VF	159	10	10	Yes	733511	1.8798	696RG1001MF	170	10	10	Yes	100443	1.295
696-G2413WF	159	10	10	Yes	102058	1.555	696RG1001VF	170	10	30	Yes	101846	-
696-G2413XF	159	10	10	Yes	458278	1.55	696RG1001WF	170	10	10	Yes	101235	1.26
696-G3011CR	179	10	10	Yes	102379	1.63	696RG1001XF	170	10	10	Yes	100450	1.245
696-G3011MR	179	10	10	Yes	462466	-	696RG1010CF	166	10	10	Yes	100467	1.3636
696-G3011PR	179	10	30	Yes	702456	1.8	696RG1010MF	166	10	10	Yes	100474	1.1873
696-G3011VR	179	10	30	Yes	700179	-	696RG1010PF	166	10	30	Yes	102409	1.4915
696-G3011WR	179	10	10	Yes	102386	1.95	696RG1010VF	166	10	10	Yes	101136	1.395
696-G3011XR	179	10	10	Yes	102393	1.91	696RG1010WF	166	10	10	Yes	100481	1.25
696-G3014CR	179	10	30	Yes	702661	-	696RG1010XF	166	10	10	Yes	100498	1.26
696-G3014MR	179	10	30	Yes	702678	-	696RG1011CF	169	10	30	Yes	102263	1.325
696-G3014PR	179	10	30	Yes	702685	-	696RG1011MF	169	10	30	Yes	102034	1.4374
696-G3014WR	179	10	30	Yes	702609	-	696RG1011XF	169	10	30	Yes	101563	1.0503
696-G3014XR	179	10	30	Yes	702623	-	696RG2001CF	174	10	10	Yes	100528	1.8716
696-G3021CR	179	10	30	Yes	702241	-	696RG2001MF	174	10	10	Yes	100535	1.55
696-G3021MR	179	10	30	Yes	702258	-	696RG2001PF	174	10	10	Yes	702777	1.5
696-G3021WR	179	10	10	Yes	700957	1.645	696RG2001VF	174	10	10	Yes	101891	1.585
696-G3021XR	179	10	30	Yes	702272	-	696RG2001WF	174	10	10	Yes	100542	1.61
696-G3024CR	179	10	30	Yes	702487	-	696RG2001XF	174	10	10	Yes	100559	1.6
696-G3024MR	179	10	30	Yes	702548	-	696RG2011CF	173	<b>10</b>	30	Yes	100870	2.0622
696-G3024WR	179	10	30	Yes	702470	-	696RG2011MF	173	10	30	Yes	102270	2.1174
696-G3024XR	179	10	30	Yes	702463	0.9253	696RG2011VF	173	10	30	Yes	726346	-
696-G4021CR	179	10	10	Yes	702524	-	696RG2011XF	173	10	30	Yes	700971	-
696-G4021MR	179	10	30	Yes	702562	-	696RG2303CF	158	10	10	Yes	100566	2.2147
696-G4021PR	179	10	30	Yes	702579	-	696RG2303MF	158	10	10	Yes	100573	2.875
696-G4021WR	179	10	30	Yes	702586	-	696RG2303VF	158	10	10	Yes	101617	2.38
696-G4021XR	179	10	30	Yes	703002	-	696RG2303WF	158	10	10	Yes	100580	2.595

Supply

Drainage

Support

Specialties

Appendix

# Numerical Index

Supply

Drainage

Support

Specialties

Appendix

Item No	Page No	Min Qty	Case Qty	UPC Bar-Coded	UPC 6-Digit	Weight (lbs.)	Item No	Page No	Min Qty	Case Qty	UPC Bar-Coded	UPC 6-Digit	Weight (lbs.)
696RG2303XF	158	10	10	Yes	100597	2.565	698RA11-MR	175	10	10	Yes	705693	2.005
696RG2313CF	158	10	10	Yes	100603	2.8233	698RA11-PR	175	10	10	Yes	705969	0.9225
696RG2313MF	158	10	10	Yes	100610	2.855	698RA11-VR	175	<b>10</b>	10	Yes	713407	-
696RG2313PF	158	10	30	Yes	102416	2.9783	698RA11-WR	175	10	10	Yes	705976	0.9225
696RG2313VF	158	10	10	Yes	102003	2.6	698RA11-XR	175	10	10	Yes	705952	0.9225
696RG2313WF	158	10	10	Yes	100627	2.82	698RA33ACR	160	10	10	Yes	706089	1.1225
696RG2313XF	158	10	10	Yes	100634	3.2058	698RA33AMR	160	10	10	Yes	706201	1.1225
696RG2403CF	159	<b>10</b>	10	Yes	707970	1.475	698RA33APR	160	10	10	Yes	706218	1.1225
696RG2403WF	159	10	10	Yes	709868	-	698RA33AWR	160	10	10	Yes	706225	1.1225
696RG2413WF	159	10	10	Yes	102904	2.218	698RA33AXR	160	10	10	Yes	706232	1.1225
696RG3011PF	180	10	10	Yes	722553	-	698RA33-CR	160	10	10	Yes	706096	0.9225
696RG3011VF	180	<b>10</b>	10	Yes	728111	-	698RA33-MR	160	10	10	Yes	706171	0.9225
696RG3011WF	180	10	10	Yes	102492	2.22	698RA33-PR	160	10	10	Yes	706164	0.9225
696RG3011XF	180	10	10	Yes	462503	1.885	698RA33-WR	160	10	10	Yes	706188	0.9225
696RG3021WF	180	10	30	Yes	711397	0.7591	698RA33-XR	160	10	10	Yes	706195	0.9225
696RG4021MF	180	10	30	Yes	723130	0.7591	698RF	216	<b>10</b>	10	Yes	700346	0.32
696RG4021WF	180	10	30	Yes	708359	0.7591	698-VC	216	<b>50</b>	50	No	437303	0.011
696RG4024XF	180	<b>10</b>	10	Yes	714244	-	699-A0-CR	166	10	10	Yes	103383	0.745
696-SC	216	<b>10</b>	10	No	153487	0.095	699-A0-MR	166	10	10	Yes	103345	0.735
696-SC1	216	<b>10</b>	10	No	101044	0.075	699-A0-PR	166	10	10	Yes	103352	0.72
696-T2001CR	174	1	10	Yes	734693	2.61	699-A0-VR	166	<b>10</b>	30	Yes	709066	-
696-T2001PR	174	1	10	Yes	734709	2.61	699-A0-WR	166	10	10	Yes	103369	0.715
696-T2001WR	174	1	10	Yes	734716	2.61	699-A0-XR	166	10	10	Yes	103376	0.72
696-T2001XR	174	1	10	Yes	734648	2.6	699-A1-CR	170	10	10	Yes	103390	0.75
697-1FL	216	10	10	No	202741	0.505	699-A1E-CR	170	10	10	Yes	702388	0.875
698-A11APR	174	10	10	Yes	103215	1.93	699-A1EMR	170	10	10	Yes	702395	0.855
698-A11AWR	174	10	10	Yes	103222	1.88	699-A1EPR	170	10	10	Yes	702401	0.83
698-A11AXR	174	10	10	Yes	103239	1.9	699-A1EVR	170	10	10	Yes	714022	0.81
698-A11-MR	174	10	10	Yes	103185	1.735	699-A1EWR	170	10	10	Yes	702449	0.82
698-A11-PR	174	10	10	Yes	103192	1.695	699-A1EXR	170	10	10	Yes	702340	0.835
698-A11-VR	174	10	10	Yes	711908	-	699-A1-MR	170	10	10	Yes	103406	0.735
698-A11-WR	174	10	10	Yes	103208	1.695	699-A1-PR	170	10	10	Yes	103413	0.715
698-A11-XR	174	10	10	Yes	103154	1.68	699-A1-VR	170	<b>10</b>	30	Yes	709073	0.715
698-A33ACR	160	10	10	Yes	103291	2.06	699-A1-WR	170	10	10	Yes	460738	0.77
698-A33AMR	160	10	10	Yes	103307	2.025	699-A1-XR	170	<b>10</b>	10	Yes	402363	0.735
698-A33APR	160	10	10	Yes	103314	2.02	699-DC	215	<b>10</b>	10	No	437310	0.1
698-A33AWR	160	10	10	Yes	103321	2.015	699-FC	216	10	200	Yes	201065	0.1312
698-A33AXR	160	10	10	Yes	103338	2.005	699RA1EMR	170	10	30	Yes	708083	-
698-A33-CR	160	10	10	Yes	103246	1.84	699RA1EPR	170	10	30	Yes	708113	0.955
698-A33-MR	160	10	10	Yes	103253	1.815	699RA1EWR	170	10	10	Yes	708090	0.85
698-A33-PR	160	10	10	Yes	103260	1.79	699RA1EXR	170	10	10	Yes	708106	0.85
698-A33-WR	160	10	10	Yes	103277	1.775	699RA1-MR	170	10	30	Yes	706928	0.8
698-A33-XR	160	10	10	Yes	103284	1.77	699RA1-PR	170	10	30	Yes	706935	-
698-DC	215	<b>24</b>	24	No	101433	0.2417	699RA1-WR	170	10	10	Yes	706850	0.75
698-EX	216	<b>10</b>	10	No	700339	0.115	699RA1-XR	170	10	10	Yes	706867	0.8
698-F	216	<b>10</b>	10	No	103161	0.195	699RF	216	<b>10</b>	10	No	700353	0.09
698RA11APR	175	10	10	Yes	705945	1.1225	700-0	771	<b>12</b>	120	No	507044	0.075
698RA11AWR	175	10	10	Yes	705990	1.1225	700-1	771	<b>12</b>	120	No	507051	0.08
698RA11AXR	175	10	10	Yes	705983	1.1225	700-2	771	<b>12</b>	120	No	507068	0.0817
698RA11-CR	175	10	10	Yes	705938	0.9225	700-3	771	<b>12</b>	120	No	403735	0.0842

Item No	Page No	Min Qty	Case Qty	UPC Bar-Coded	UPC 6-Digit	Weight (lbs.)	Item No	Page No	Min Qty	Case Qty	UPC Bar-Coded	UPC 6-Digit	Weight (lbs.)
700-4	771	<b>12</b>	120	No	403742	0.09	800-PBW	433	12	12	Yes	300157	2.8021
700-5	771	<b>6</b>	60	No	507099	0.111	800-PPK	433	3	3	Yes	300089	3.0578
700-6	771	<b>6</b>	60	No	507105	0.1098	801-A	438	1	25	Yes	300096	0.329
700-7	771	<b>6</b>	60	No	507112	0.1167	801-A2	438	1	25	Yes	380180	0.2293
702-2	771	<b>24</b>	240	No	507150	0.053	801-APK	438	10	10	Yes	300348	0.3075
702-3	771	<b>24</b>	240	No	507167	0.055	801-DR2	438	1	10	Yes	380173	1.5251
702-4	771	<b>24</b>	240	No	507174	0.064	801-NQ2	438	1	10	Yes	380166	2.4745
703-2	771	<b>24</b>	240	No	507181	0.054	801-NR2	438	1	10	Yes	380197	1.3047
703-3	771	<b>24</b>	240	No	507198	0.056	801-P	438	1	25	Yes	300126	0.334
703-4	771	<b>24</b>	240	No	507204	0.063	801-P2	438	1	25	Yes	380159	0.2293
703-5	771	<b>12</b>	120	No	507211	0.0793	801-P2PK	438	10	10	Yes	380159	0.2224
703-6	771	<b>6</b>	60	No	507228	0.1008	801-PG2	438	1	25	Yes	309273	0.2256
703-7	771	<b>6</b>	60	No	507235	0.109	801-PPK	438	10	10	Yes	300324	0.3121
704-2	771	<b>12</b>	72	No	507242	0.096	801-SQ2	438	1	10	Yes	309204	2.37
704-3	771	<b>12</b>	72	No	507259	0.096	801-SR2	438	1	10	Yes	309198	1.178
704-4	771	<b>12</b>	72	No	507266	0.1083	802-7	433	12	12	Yes	300027	0.1625
705-2	771	<b>12</b>	120	No	507273	0.11	803-2PK2	454	12	12	Yes	300058	0.2423
705-3	771	<b>12</b>	120	No	507280	0.127	803-3PK2	454	12	12	Yes	300065	0.5934
705-4	771	<b>12</b>	120	No	507297	0.1217	803-4PK2	454	12	12	Yes	300072	1.086
706-2	771	<b>12</b>	72	No	507303	0.042	819-2A	428	<b>6</b>	6	Yes	734907	4.702
706-3	771	<b>12</b>	72	No	507310	0.0726	819-2P	428	<b>6</b>	6	Yes	734914	1.2917
706-4	771	<b>12</b>	72	No	507327	0.077	820-20PCQ	421	<b>6</b>	6	Yes	725462	0.064
707-2	771	<b>12</b>	72	No	507334	0.0681	820-20PCR	421	<b>6</b>	6	Yes	725455	0.064
707-3	771	<b>12</b>	72	No	509505	0.0712	820-20PKQ	421	<b>6</b>	6	Yes	725479	0.1572
707-4	771	<b>12</b>	72	No	507358	0.0738	820-20PKR	421	<b>6</b>	6	Yes	725486	0.0639
710-2	772	<b>6</b>	120	No	404022	0.058	820-20PRBQ	421	<b>6</b>	6	Yes	725493	0.0631
710-3	772	<b>6</b>	120	No	404039	0.0573	820-20PRBR	421	<b>6</b>	6	Yes	725509	0.0639
710-4	772	<b>6</b>	120	No	507389	0.1038	820-27P	421	<b>20</b>	20	Yes	725103	-
730-05	772	<b>24</b>	24	Yes	405968	0.308	820-27PQ	421	<b>20</b>	20	Yes	725110	-
730-10	772	<b>24</b>	24	Yes	403025	0.35	820-2P	421	<b>20</b>	20	Yes	725080	-
730-25	772	<b>12</b>	12	Yes	405975	1.4625	820-20PCQ	421	<b>6</b>	6	Yes	725547	0.1472
740-02	772	<b>50</b>	50	Yes	406019	0.084	820-T20PCR	421	<b>6</b>	6	Yes	725554	0.1472
740-05	772	<b>24</b>	24	Yes	405982	0.236	820-T20PKQ	421	<b>6</b>	6	Yes	725561	0.2404
740-10	772	<b>24</b>	24	Yes	403056	0.426	820-T20PKR	421	<b>6</b>	6	Yes	725578	0.1471
740-25	772	<b>12</b>	12	Yes	405951	1.2292	820-T20PRBQ	421	<b>6</b>	6	Yes	725608	0.1464
743-05	772	<b>24</b>	24	Yes	405999	0.364	820-T20PRBR	421	<b>6</b>	6	Yes	725615	0.1464
743-10	772	<b>24</b>	24	Yes	403353	0.568	820-T27P	421	<b>10</b>	10	Yes	725158	0.655
743-25	772	<b>12</b>	12	Yes	406002	1.0817	820-T27PQ	421	<b>10</b>	10	Yes	725165	-
750-46	772	<b>14</b>	14	No	507495	0.3029	820-T2P	421	<b>10</b>	10	Yes	725097	0.66
750-69	772	<b>12</b>	12	No	507501	0.358	821-200A	415	<b>20</b>	20	Yes	300140	0.6748
752-69	772	<b>12</b>	12	No	507518	0.3797	821-200ACQ	417	<b>5</b>	5	Yes	312280	1.96
771	771	<b>1</b>	12	No	507525	2.194	821-200ACR	417	<b>5</b>	5	Yes	312273	1.7
772	771	<b>1</b>	12	No	507532	2.433	821-200AKQ	417	<b>5</b>	5	Yes	325563	1.5747
773	771	<b>36</b>	360	No	507549	0.036	821-200AKR	417	<b>5</b>	5	Yes	325570	1.26
774	771	<b>36</b>	36	No	507556	0.0292	821-200ANQ	416	<b>5</b>	5	Yes	356376	1.7308
776	771	<b>24</b>	24	No	507563	0.071	821-200ANR	416	<b>5</b>	5	Yes	301932	1.5504
800-A	433	<b>12</b>	12	Yes	300102	2.1502	821-200ARBQ	419	<b>5</b>	5	Yes	352316	1.762
800-ABW	433	12	12	Yes	300133	2.2107	821-200ARBR	419	<b>5</b>	5	Yes	352323	1.5616
800-APK	433	3	3	Yes	300102	2.3985	821-200ASQ	418	<b>5</b>	5	Yes	307378	1.96
800-P	433	<b>12</b>	12	Yes	300089	2.7111	821-200ASR	418	<b>5</b>	5	Yes	307385	1.7

Supply

Drainage

Support

Specialties

Appendix

# Numerical Index

Supply

Drainage

Support

Specialties

Appendix

Item No	Page No	Min Qty	Case Qty	UPC Bar-Coded	UPC 6-Digit	Weight (lbs.)	Item No	Page No	Min Qty	Case Qty	UPC Bar-Coded	UPC 6-Digit	Weight (lbs.)
821-200P	415	<b>20</b>	20	Yes	300171	0.9245	821-2PQCP	419	<b>5</b>	5	Yes	381194	1.59
821-200PCQ	417	<b>5</b>	5	Yes	312266	2.09	821-2PQRB	419	1	5	Yes	309631	1.988
821-200PCR	417	<b>5</b>	5	Yes	312242	1.18	821-2PT4A	420	<b>1</b>	5	Yes	325327	1.01
821-200PKQ	417	<b>5</b>	5	Yes	324597	1.67	821-2PT5A	420	1	5	Yes	325488	1.17
821-200PKR	417	<b>5</b>	5	Yes	324580	1.485	821-2PTQ	420	1	1	Yes	322821	1.8415
821-200PNQ	416	<b>5</b>	5	Yes	301963	1.875	821-2QAS	416	5	5	Yes	313010	0.304
821-200PNR	416	<b>5</b>	5	Yes	301925	1.7604	821-2S	429	1	100	Yes	300393	0.2219
821-200PRBQ	419	<b>5</b>	5	Yes	352330	1.94	821-2SCQPK1	430	1	10	Yes	320865	0.7213
821-200PRBR	419	<b>5</b>	5	Yes	352347	1.7749	821-2SCQPK2	430	1	50	Yes	320926	0.9796
821-200PSQ	418	<b>5</b>	5	Yes	307392	2.09	821-2SCRPK1	429	1	10	Yes	320858	0.9935
821-200PSR	418	<b>5</b>	5	Yes	307422	1.85	821-2SCRPK2	429	1	50	Yes	320933	0.723
821-270A	415	<b>20</b>	20	Yes	351562	0.6928	821-2SKQPK1	430	1	10	Yes	324634	0.707
821-270AQ	415	<b>20</b>	20	Yes	318510	0.9075	821-2SKQPK2	430	1	50	Yes	320841	0.6465
821-270P	415	<b>20</b>	20	Yes	300249	1.2815	821-2SKRPK1	429	6	6	Yes	324627	0.7167
821-270PQ	415	<b>20</b>	20	Yes	318527	1.253	821-2SKRPK2	429	1	50	Yes	320834	0.4342
821-2A	415	<b>20</b>	20	Yes	300416	0.6806	821-2SMQPK2	430	<b>5</b>	5	Yes	703569	0.56
821-2APK	415	<b>8</b>	8	Yes	378323	0.6685	821-2SMRPK2	429	1	5	Yes	703576	0.39
821-2AQCP	419	<b>5</b>	5	Yes	381200	1.93	821-2SNQPK1	430	1	10	Yes	321053	1.4115
821-2AQRB	419	<b>5</b>	5	Yes	309617	1.842	821-2SNRPK1	430	6	6	Yes	315427	0.8831
821-2AT4A	420	<b>1</b>	5	Yes	325310	0.88	821-2SPK1	429	10	10	Yes	300904	0.249
821-2AT5A	420	1	5	Yes	325464	1.06	821-2SRBQPK1	430	1	10	Yes	320872	1.0154
821-2ATQ	420	1	1	Yes	322807	1.7525	821-2SRBQPK2	430	1	50	Yes	320940	0.8982
821-2IFS	423	4	4	Yes	375223	4.05	821-2SRBRPK1	429	6	6	Yes	315441	0.8833
821-2IH	423	1	10	Yes	318602	3.985	821-2SRBRPK2	429	1	50	Yes	320957	0.6692
821-2IHCP	423	1	5	Yes	318619	1.4512	821-2SSQPK1	430	1	10	Yes	321060	1.144
821-2IHQCP	423	1	5	Yes	318626	5.17	821-2SSRPK1	430	1	10	Yes	321022	0.8699
821-2INS	423	1	4	Yes	378309	4.4375	821-EX2	415	1	10	Yes	327536	0.13
821-2IT	423	1	10	Yes	318633	4.735	821-EX2	416	1	10	Yes	327536	0.13
821-2ITCP	423	1	5	Yes	318640	0.9912	821-EX2	416	1	10	Yes	327536	0.13
821-2ITQCP	423	1	5	Yes	318657	0.01	821-EX2	417	1	10	Yes	327536	0.13
821-2LCQ	417	1	5	Yes	319128	1.0702	821-EX2	418	1	10	Yes	327536	0.13
821-2LCR	417	1	5	Yes	319111	0.84	821-EX2	418	1	10	Yes	327536	0.13
821-2LKQ	418	1	5	Yes	325587	0.9902	821-EX2	419	1	10	Yes	327536	0.13
821-2LKR	418	<b>1</b>	5	Yes	325600	0.7802	821-EX2	420	1	10	Yes	327536	0.13
821-2LNQ	416	1	5	Yes	319067	1.4459	821-EX2	421	1	10	Yes	327536	0.13
821-2LNR	416	1	5	Yes	319050	0.9573	821-EX2	423	1	10	Yes	327536	0.13
821-2LQRB	420	1	5	Yes	319234	0.83	821-EX2	424	1	10	Yes	327536	0.13
821-2LRBQ	419	1	5	Yes	319142	1.07	821-EX2	425	1	10	Yes	327536	0.13
821-2LRBR	419	1	5	Yes	319104	0.8	821-H	415	<b>10</b>	100	No	326522	0.0535
821-2LSNQ	416	<b>10</b>	10	Yes	331120	0.3589	821-H	416	<b>10</b>	100	No	326522	0.0535
821-2LSPC	415	10	10	Yes	318763	0.8944	821-H	416	<b>10</b>	100	No	326522	0.0535
821-2LSPCI	415	10	10	Yes	318732	0.1287	821-H	417	<b>10</b>	100	No	326522	0.0535
821-2LSPN	416	10	10	Yes	319036	0.8934	821-H	418	<b>10</b>	100	No	326522	0.0535
821-2LSQ	418	1	5	Yes	319081	1.0895	821-H	418	<b>10</b>	100	No	326522	0.0535
821-2LSR	418	1	5	Yes	319074	0.87	821-H	419	<b>10</b>	100	No	326522	0.0535
821-2LT4A	420	<b>1</b>	4	Yes	325341	0.45	821-H	421	<b>10</b>	100	No	326522	0.0535
821-2LT5A	420	1	10	Yes	325457	0.615	821-H	421	<b>10</b>	100	No	326522	0.0535
821-2LTQ	420	1	20	Yes	322814	1.0025	821-H	426	<b>10</b>	100	No	326522	0.0535
821-2P	415	<b>20</b>	20	Yes	300355	0.9206	821-H	426	<b>10</b>	100	No	326522	0.0535
821-2PPK	415	8	8	Yes	378330	0.8293	821-H	427	<b>10</b>	100	No	326522	0.0535

Item No	Page No	Min Qty	Case Qty	UPC Bar-Coded	UPC 6-Digit	Weight (lbs.)	Item No	Page No	Min Qty	Case Qty	UPC Bar-Coded	UPC 6-Digit	Weight (lbs.)
821-H	427	<b>10</b>	100	No	326522	0.0535	821-T2ACP	419	1	5	Yes	381132	1.8517
821-HA2	415	25	25	Yes	318701	0.9276	821-T2AQCP	419	1	5	Yes	381149	1.98
821-HA2	416	25	25	Yes	318701	0.9276	821-T2AQRB	419	1	5	Yes	309655	1.994
821-HP2	415	25	25	Yes	318695	0.9519	821-T2AT4A	420	1	5	Yes	325358	1.04
821-HP2	416	25	25	Yes	318695	0.9519	821-T2AT5A	420	1	5	Yes	325471	1.2
821-HQCP	420	1	5	Yes	308979	0.9195	821-T2ATQ	420	1	1	Yes	322838	1.7862
821-HQCP	423	1	5	Yes	308979	0.9195	821-T2P	415	1	10	Yes	381156	0.9619
821-HSQ	423	1	10	Yes	379771	0.0876	821-T2P	418	1	10	Yes	381156	0.9619
821-HSR	423	1	10	Yes	379757	0.1126	821-T2PCP	419	1	5	Yes	381163	1.8331
821-MHA2	416	25	25	Yes	329547	0.446	821-T2PQCP	419	1	5	Yes	381170	2.14
821-MHA2	417	25	25	Yes	329547	0.446	821-T2PQRB	419	1	5	Yes	309679	1.5
821-MHA2	418	25	25	Yes	329547	0.446	821-T2PT4A	420	1	5	Yes	325365	1.08
821-MHA2	418	25	25	Yes	329547	0.446	821-T2PT5A	420	1	5	Yes	325495	1.23
821-MHA2	419	25	25	Yes	329547	0.446	821-T2PTQ	420	1	1	Yes	322845	1.8751
821-MHA2	420	25	25	Yes	329547	0.446	821-THA2	415	25	25	Yes	318725	0.9309
821-MHA2	420	25	25	Yes	329547	0.446	821-THA2	416	25	25	Yes	318725	0.9309
821-MHP2	416	<b>25</b>	25	Yes	329455	0.468	821-THP2	415	25	25	Yes	318718	0.9123
821-MHP2	417	<b>25</b>	25	Yes	329455	0.468	821-THP2	416	25	25	Yes	318718	0.9123
821-MHP2	418	<b>25</b>	25	Yes	329455	0.468	821-TMHA2	416	25	25	Yes	703224	0.4187
821-MHP2	418	<b>25</b>	25	Yes	329455	0.468	821-TMHA2	417	25	25	Yes	703224	0.4187
821-MHP2	419	<b>25</b>	25	Yes	329455	0.468	821-TMHA2	418	25	25	Yes	703224	0.4187
821-MHP2	420	<b>25</b>	25	Yes	329455	0.468	821-TMHA2	418	25	25	Yes	703224	0.4187
821-MHP2	420	<b>25</b>	25	Yes	329455	0.468	821-TMHA2	419	25	25	Yes	703224	0.4187
821-MHP2	420	<b>25</b>	25	Yes	329455	0.468	821-TMHA2	419	25	25	Yes	703224	0.4187
821-T200A	415	10	10	Yes	380951	0.7009	821-TMHA2	420	25	25	Yes	703224	0.4187
821-T200ACQ	417	1	5	Yes	312433	1.96	821-TMHA2	420	25	25	Yes	703224	0.4187
821-T200ACR	417	5	5	Yes	312402	0.3605	821-TMHP2	416	25	25	Yes	703231	0.4583
821-T200AKQ	417	1	5	Yes	325631	2.387	821-TMHP2	417	25	25	Yes	703231	0.4583
821-T200AKR	417	1	5	Yes	325648	1.3679	821-TMHP2	418	25	25	Yes	703231	0.4583
821-T200ANQ	416	1	5	Yes	380968	2.3821	821-TMHP2	418	25	25	Yes	703231	0.4583
821-T200ANR	416	5	5	Yes	380975	1.8832	821-TMHP2	419	25	25	Yes	703231	0.4583
821-T200ARBQ	419	1	5	Yes	380982	3.2613	821-TMHP2	420	25	25	Yes	703231	0.4583
821-T200ARBR	419	1	5	Yes	380999	1.865	821-TMHP2	420	25	25	Yes	703231	0.4583
821-T200ASQ	418	1	5	Yes	310262	2.005	821-TP	415	10	10	Yes	381187	0.0229
821-T200ASR	418	5	5	Yes	310279	1.748	821-TP	416	10	10	Yes	381187	0.0229
821-T200P	415	<b>10</b>	10	Yes	381002	0.9658	821-TP	416	10	10	Yes	381187	0.0229
821-T200PCQ	417	1	5	Yes	312440	1.73	821-TP	417	10	10	Yes	381187	0.0229
821-T200PCR	417	5	5	Yes	312457	1.892	821-TP	418	10	10	Yes	381187	0.0229
821-T200PKQ	417	1	5	Yes	325655	1.74	821-TP	419	10	10	Yes	381187	0.0229
821-T200PKR	417	5	5	Yes	325693	1.4569	821-TP	420	10	10	Yes	381187	0.0229
821-T200PNQ	416	5	5	Yes	381019	2.3635	821-TP	421	10	10	Yes	381187	0.0229
821-T200PNR	416	5	5	Yes	381026	1.8645	821-TP	421	10	10	Yes	381187	0.0229
821-T200PRBQ	419	1	5	Yes	381033	3.2427	821-TP	424	10	10	Yes	381187	0.0229
821-T200PRBR	419	1	5	Yes	381040	1.6747	821-TP	425	10	10	Yes	381187	0.0229
821-T200PSQ	418	1	5	Yes	310286	2.15	822-2AF	348	<b>1</b>	4	Yes	379146	1.7645
821-T200PSR	418	5	5	Yes	310293	1.896	822-2ANQ	347	<b>1</b>	4	Yes	305640	3.7981
821-T270A	415	1	10	Yes	381071	0.965	822-2ANR	347	<b>1</b>	4	Yes	300621	3.0931
821-T270AQ	415	<b>1</b>	10	Yes	318534	1.168	822-2AS	347	<b>1</b>	4	Yes	301413	2.2373
821-T270P	415	<b>10</b>	10	Yes	381088	0.8893	822-2ASQ	347	<b>1</b>	4	Yes	307439	3.4531
821-T270PQ	415	1	10	Yes	309600	1.1	822-2ASR	347	<b>1</b>	4	Yes	307446	2.675
821-T2A	415	1	10	Yes	381231	0.7067	822-2DF	261	<b>1</b>	1	Yes	381361	7.0875

Supply

Drainage

Support

Specialties

Appendix

# Numerical Index

Supply

Drainage

Support

Specialties

Appendix

Item No	Page No	Min Qty	Case Qty	UPC Bar-Coded	UPC 6-Digit	Weight (lbs.)	Item No	Page No	Min Qty	Case Qty	UPC Bar-Coded	UPC 6-Digit	Weight (lbs.)
822-2DNQ	261	1	4	Yes	381330	7.9125	822-CF3ANQ	373	1	1	Yes	315519	5.7369
822-2DNR	261	1	4	Yes	381316	6.9	822-CF3ANR	373	1	1	Yes	315526	5.0469
822-2DSQ	261	1	4	Yes	307453	7.5375	822-CF3ASQ	373	1	1	Yes	315533	5.4069
822-2DSR	261	1	4	Yes	307460	7.1875	822-CF3ASR	373	1	1	Yes	315540	4.6969
822-2PF	348	1	4	Yes	379139	2.4138	822-CF3DNQ	308	1	1	Yes	315717	8.0734
822-2PNQ	347	1	4	Yes	301796	3.9051	822-CF3DNR	308	1	1	Yes	314505	11.2417
822-2PNR	347	1	4	Yes	304070	3.2001	822-CF3DSQ	308	1	1	Yes	314857	11.191
822-2PS	347	1	4	Yes	304087	2.3443	822-CF3DSR	308	1	1	Yes	313546	10.5866
822-2PSQ	347	1	4	Yes	307477	3.675	822-CF3PNQ	373	1	1	Yes	315557	5.8409
822-2PSR	347	1	4	Yes	307484	2.9601	822-CF3PNR	373	1	1	Yes	313485	5.1335
822-3AF	348	1	4	Yes	379153	2.3048	822-CF3PSQ	373	1	1	Yes	315564	5.8145
822-3ANQ	347	1	4	Yes	304865	3.7961	822-CF3PSR	373	1	1	Yes	315571	4.7835
822-3ANR	347	1	4	Yes	304896	3.0911	822-CKIT	347	1	10	Yes	316585	0.644
822-3AS	347	1	4	Yes	304926	2.2353	822-CKIT	349	1	10	Yes	316585	0.644
822-3ASQ	347	1	4	Yes	307491	3.4511	822-EX3	329	1	1	No	309792	1.8
822-3ASR	347	1	1	Yes	307521	2.9	822-EX3	344	1	1	No	309792	1.8
822-3DF	261	1	4	Yes	381378	6.825	822-EX3	347	1	1	No	309792	1.8
822-3DNQ	261	1	4	Yes	381323	7.75	822-EX3	349	1	1	No	309792	1.8
822-3DNR	261	1	4	Yes	381347	7.0375	822-EX3	372	1	1	No	309792	1.8
822-3DSQ	261	1	1	Yes	307538	7.4179	822-EX3	373	1	1	No	309792	1.8
822-3DSR	261	1	1	Yes	307545	6.95	822-EX3	422	1	1	No	309792	1.8
822-3PF	348	1	4	Yes	379160	2.4191	822-EX3CQ	261	1	1	Yes	309792	1.5
822-3PNQ	347	1	4	Yes	304957	3.9001	822-EX3CQ	262	1	1	Yes	309792	1.5
822-3PNR	347	1	4	Yes	305152	2.9916	822-F2ANQ	348	1	1	Yes	380272	4.1769
822-3PS	347	1	4	Yes	305442	2.1125	822-F2ANR	348	1	1	Yes	380258	4.2321
822-3PSQ	347	1	4	Yes	307552	3.675	822-F2ASQ	348	1	1	Yes	307576	3.8362
822-3PSR	347	1	4	Yes	307569	2.475	822-F2ASR	348	1	1	Yes	307583	3.9921
822-C3AF	372	1	1	Yes	315403	3.29	822-F2DNQ	262	1	1	Yes	381392	11.15
822-C3ANQ	372	1	1	Yes	315182	5.3073	822-F2DNR	262	1	1	Yes	381385	10.15
822-C3ANR	372	1	1	Yes	379993	4.6262	822-F2DSQ	262	1	1	Yes	307590	10.6256
822-C3ASQ	372	1	1	Yes	315199	4.9773	822-F2DSR	262	1	1	Yes	307620	10.0256
822-C3ASR	372	1	1	Yes	315205	4.2673	822-F2PNQ	348	1	1	Yes	380265	4.1769
822-C3DF	308	1	1	Yes	315663	4.4167	822-F2PNR	348	1	1	Yes	380241	3.5789
822-C3DNQ	308	1	1	Yes	315335	8.4684	822-F2PSQ	348	1	1	Yes	307637	4.85
822-C3DNR	308	1	4	Yes	315298	7.37	822-F2PSR	348	1	1	Yes	307644	2.5365
822-C3DSQ	308	1	1	Yes	315373	8.1252	822-F3ANQ	348	1	1	Yes	380333	4.1749
822-C3DSR	308	1	1	Yes	315342	7.4152	822-F3ANR	348	1	1	Yes	380319	4.2301
822-C3PF	372	1	1	Yes	315458	3.394	822-F3ASQ	348	1	1	Yes	307651	4.4049
822-C3PNQ	372	1	1	Yes	312082	5.4113	822-F3ASR	348	1	1	Yes	307668	3.9901
822-C3PNR	372	1	4	Yes	379931	3.7188	822-F3DNQ	262	1	1	Yes	381415	10.8
822-C3PSQ	372	1	1	Yes	315212	5.0813	822-F3DNR	262	1	1	Yes	381408	10.2
822-C3PSR	372	1	4	Yes	315229	3.6	822-F3DSQ	262	1	1	Yes	307675	10.3816
822-C4ANQ	372	1	1	Yes	315236	4.686	822-F3DSR	262	1	1	Yes	307682	10.04
822-C4ANR	372	1	1	Yes	377487	3.25	822-F3PNQ	348	1	1	Yes	380326	4.2789
822-C4ASQ	372	1	1	Yes	315243	4.686	822-F3PNR	348	1	1	Yes	380302	4.3341
822-C4ASR	372	1	1	Yes	315250	3.646	822-F3PSQ	348	1	1	Yes	307699	4.6941
822-C4PNQ	372	1	1	Yes	315267	4.79	822-F3PSR	348	1	1	Yes	307705	4.0941
822-C4PNR	372	1	1	Yes	379344	4.1	822-S2A	422	6	6	Yes	733894	1.5
822-C4PSQ	372	1	1	Yes	315274	4.46	822-S2P	422	6	6	Yes	733900	1.5
822-C4PSR	372	1	4	Yes	315281	3.7	822-TB	347	1	10	Yes	379573	0.14



Item No	Page No	Min Qty	Case Qty	UPC Bar-Coded	UPC 6-Digit	Weight (lbs.)	Item No	Page No	Min Qty	Case Qty	UPC Bar-Coded	UPC 6-Digit	Weight (lbs.)
823-24PSS	425	1	1	Yes	314796	8.805	825-17P	426	20	20	Yes	356277	0.6939
823-32PSS	425	1	1	Yes	314819	11.685	825-1P	426	20	20	Yes	356291	0.6988
823-32PST	425	1	1	Yes	326096	11.7	825-20A	426	20	20	Yes	300423	0.4143
823-40PSS	425	1	1	Yes	314833	14.1	825-20P	426	20	20	Yes	300430	0.5875
823-60PSS	425	1	1	Yes	314529	19.25	825-27A	426	20	20	Yes	300447	0.5172
823-60PST	425	1	1	Yes	326119	19.55	825-27P	426	<b>20</b>	20	Yes	300454	0.5775
823-T2A36T	425	1	1	Yes	330130	-	825-2A	426	<b>20</b>	20	Yes	300478	0.5215
823-T2A36V	425	1	1	Yes	330260	5.1	825-2AFS	426	10	10	Yes	301574	0.2029
823-T2A72T	425	1	1	Yes	330208	14.5187	825-2APK	426	12	12	Yes	301543	0.6051
823-T2A72V	425	1	1	Yes	330215	-	825-2P	426	<b>20</b>	20	Yes	300492	0.5833
823-T2P36T	425	1	1	Yes	330161	9.1501	825-2PFS	426	<b>10</b>	10	Yes	301550	0.828
823-T2P36V	425	<b>1</b>	1	Yes	330321	4.95	825-2PPK	426	12	12	Yes	301505	0.5913
823-T2P72T	425	1	1	Yes	330178	12.05	826-2A	427	1	20	Yes	301826	0.5193
823-T2P72V	425	1	1	Yes	330246	8.75	826-2P	427	1	20	Yes	352231	0.5888
823-TX26SA	424	<b>1</b>	1	Yes	324979	6.316	826-2PPK	427	10	10	Yes	301802	0.6226
823-TX26SP	424	<b>1</b>	1	Yes	323736	5.3	827-2B	426	<b>20</b>	20	Yes	301765	1.3075
823-TX26TA	424	<b>1</b>	1	Yes	323767	6.5072	827-2BG	426	1	100	No	300577	0.059
823-TX26TP	424	<b>1</b>	1	Yes	323583	6.5962	827-2BG	427	1	100	No	300577	0.059
823-TX26WA	424	<b>1</b>	1	Yes	323705	7.8072	827-2J	427	1	20	Yes	302045	1.535
823-TX26WP	424	<b>1</b>	1	Yes	323521	7.2	827-2RBPK2	429	5	5	Yes	320964	0.1412
823-TX30SA	424	<b>1</b>	1	Yes	323835	6.916	827-2RBQ	429	1	100	Yes	331144	0.2145
823-TX30SP	424	<b>1</b>	1	Yes	323651	5.8	827-2RBQPK1	429	1	5	Yes	722959	0.27
823-TX30TA	424	<b>1</b>	1	Yes	323774	7.1072	827-2S	429	1	100	Yes	300645	0.1482
823-TX30TP	424	<b>1</b>	1	Yes	323590	7.1962	827-2SMQPK1	429	1	5	Yes	703583	0.27
823-TX30WA	424	<b>1</b>	1	Yes	323712	9.3072	827-2SMRPK1	429	<b>5</b>	5	Yes	703590	0.22
823-TX30WP	424	<b>1</b>	1	Yes	323538	8.2	827-2SNPK2	429	<b>5</b>	5	Yes	320988	0.21
823-TX36SA	424	<b>1</b>	1	Yes	323842	7.5072	827-2SNQPK1	429	1	5	Yes	722973	0.28
823-TX36SP	424	<b>1</b>	1	Yes	323668	6.7	827-2SPK1	429	10	10	Yes	301741	0.204
823-TX36TA	424	<b>1</b>	1	Yes	324986	8.1072	827-2SPPK1	429	1	5	Yes	301758	0.28
823-TX36TP	424	<b>1</b>	1	Yes	329370	7.5	827-2SQPK1	429	1	5	Yes	722980	0.27
823-TX36WA	424	<b>1</b>	1	Yes	323729	10.7072	827-2SWPK1	429	1	5	Yes	315410	0.22
823-TX36WP	424	<b>1</b>	1	Yes	323545	9.2	828-2	426	<b>20</b>	20	Yes	300676	0.6066
823-TX40SA	424	<b>1</b>	1	Yes	323859	7.9072	828-2PK	426	10	10	Yes	301710	0.5466
823-TX40SP	424	<b>1</b>	1	Yes	323675	7.9962	828-GC	426	1	10	No	328298	0.13
823-TX40TA	424	<b>1</b>	1	Yes	324900	8.7072	828-GC	427	1	10	No	328298	0.13
823-TX40TP	424	<b>1</b>	1	Yes	329387	7.85	832-25AF	328	<b>1</b>	10	Yes	305459	1.2149
823-TX40WA	424	<b>1</b>	1	Yes	325167	11.5072	832-25ANQ	329	<b>1</b>	1	Yes	305466	4.0067
823-TX40WP	424	<b>1</b>	1	Yes	323552	11.43	832-25ANR	329	<b>1</b>	1	Yes	305473	3.2705
823-TX48SA	424	<b>1</b>	1	Yes	323866	8.5139	832-25ASQ	329	<b>1</b>	1	Yes	307712	3.6617
823-TX48SP	424	<b>1</b>	1	Yes	323682	8.65	832-25ASR	329	<b>1</b>	1	Yes	307729	3
823-TX48TA	424	<b>1</b>	1	Yes	323804	9.9072	832-25DF	246	<b>1</b>	1	Yes	381446	5.995
823-TX48TP	424	<b>1</b>	1	Yes	323620	9.9962	832-25DNQ	246	<b>1</b>	1	Yes	381484	9.95
823-TX48WA	424	<b>1</b>	1	Yes	323743	13.5072	832-25DNR	246	<b>1</b>	1	Yes	381460	9.15
823-TX48WP	424	<b>1</b>	1	Yes	323569	12.5	832-25DSQ	246	<b>1</b>	1	Yes	307736	9.6662
823-TX60SA	424	<b>1</b>	1	Yes	323873	11.1072	832-25DSR	246	<b>1</b>	1	Yes	307743	9.05
823-TX60SP	424	<b>1</b>	1	Yes	323699	10.15	832-25PF	328	<b>1</b>	10	Yes	306173	1.37
823-TX60TA	424	<b>1</b>	1	Yes	323811	12.2139	832-25PNQ	329	<b>1</b>	1	Yes	306180	3.5073
823-TX60TP	424	<b>1</b>	1	Yes	329394	12.65	832-25PNR	329	<b>1</b>	1	Yes	306197	2.7711
823-TX60WA	424	<b>1</b>	1	Yes	323750	16.516	832-25PSQ	329	<b>1</b>	1	Yes	307750	3.1623
823-TX60WP	424	<b>1</b>	1	Yes	323576	14.35	832-25PSR	329	<b>1</b>	1	Yes	307767	3

Supply

Drainage

Support

Specialties

Appendix

# Numerical Index

Supply

Drainage

Support

Specialties

Appendix

Item No	Page No	Min Qty	Case Qty	UPC Bar-Coded	UPC 6-Digit	Weight (lbs.)	Item No	Page No	Min Qty	Case Qty	UPC Bar-Coded	UPC 6-Digit	Weight (lbs.)
832-2AF	327	1	10	Yes	377425	1.7364	832-3DHSR	254	1	1	Yes	381637	2.7
832-2ANQ	327	1	1	Yes	377418	5.091	832-3DHSR	261	1	1	Yes	381637	2.7
832-2ANR	327	1	1	Yes	377395	3.937	832-3DIR	245	1	1	Yes	376053	10.325
832-2ASQ	327	1	1	Yes	307774	4.9099	832-3DNQ	245	1	1	Yes	376060	11.0378
832-2ASR	327	1	1	Yes	307781	3.7	832-3DNR	245	1	1	Yes	376077	10.1486
832-2PF	327	1	10	Yes	376565	2.0409	832-3DSQ	245	1	1	Yes	381781	11.0786
832-2PNQ	327	1	1	Yes	377401	5.3261	832-3DSR	245	1	1	Yes	381798	9.9
832-2PNR	327	1	1	Yes	376510	4.4345	832-3HHD	328	1	10	Yes	315793	0.795
832-2PSQ	327	1	1	Yes	307798	4.9	832-3HHD	336	1	10	Yes	315793	0.795
832-2PSR	327	1	1	Yes	307804	4	832-3HHD	339	1	10	Yes	315793	0.795
832-35AF	328	1	10	Yes	306210	1.2129	832-3HHD	341	1	10	Yes	315793	0.795
832-35ANQ	329	1	1	Yes	306227	4.0047	832-3HHD	348	1	10	Yes	315793	0.795
832-35ANR	329	1	1	Yes	306234	3.2685	832-3HNQ	328	1	10	Yes	306289	2.2
832-35ASQ	329	1	1	Yes	307811	3.6597	832-3HNQ	336	1	10	Yes	306289	2.2
832-35ASR	329	1	1	Yes	307828	3.0285	832-3HNQ	339	1	10	Yes	306289	2.2
832-35DF	246	1	1	Yes	381453	6.3735	832-3HNQ	341	1	10	Yes	306289	2.2
832-35DNQ	246	1	1	Yes	381491	9.4	832-3HNQ	348	1	10	Yes	306289	2.2
832-35DNR	246	1	1	Yes	381477	9.4	832-3HNR	328	1	10	Yes	306296	1.5212
832-35DSQ	246	1	1	Yes	307835	9.75	832-3HNR	336	1	10	Yes	306296	1.5212
832-35DSR	246	1	1	Yes	307842	8.65	832-3HNR	339	1	10	Yes	306296	1.5212
832-35PF	328	1	10	Yes	306241	1.3413	832-3HNR	341	1	10	Yes	306296	1.5212
832-35PNQ	329	1	1	Yes	306258	4.1087	832-3HNR	348	1	10	Yes	306296	1.5212
832-35PNR	329	1	1	Yes	306272	3.3725	832-3HS	328	1	20	No	708366	0.72
832-35PSQ	329	1	1	Yes	307859	3.6	832-3HS	336	1	20	No	708366	0.72
832-35PSR	329	1	1	Yes	307866	3	832-3HS	339	1	20	No	708366	0.72
832-36AF	327	1	10	Yes	374677	1.413	832-3HS	341	1	20	No	708366	0.72
832-36ANQ	327	1	1	Yes	374806	4.8811	832-3HS	348	1	20	No	708366	0.72
832-36ANR	327	1	1	Yes	374721	3.45	832-3HSQ	328	1	10	Yes	381644	2.076
832-36ASQ	327	1	1	Yes	381583	4.6099	832-3HSQ	336	1	10	Yes	381644	2.076
832-36ASR	327	1	1	Yes	381590	3.38	832-3HSQ	339	1	10	Yes	381644	2.076
832-36PF	327	1	10	Yes	374226	1.5898	832-3HSQ	341	1	10	Yes	381644	2.076
832-36PNQ	327	1	1	Yes	374530	5.0345	832-3HSQ	348	1	10	Yes	381644	2.076
832-36PNR	327	1	1	Yes	374462	3.5	832-3HSR	328	1	10	Yes	381651	1.53
832-36PSQ	327	1	1	Yes	381606	4.8	832-3HSR	336	1	10	Yes	381651	1.53
832-36PSR	327	1	1	Yes	381613	3.65	832-3HSR	339	1	10	Yes	381651	1.53
832-3DF	245	1	5	Yes	376046	6.6064	832-3HSR	341	1	10	Yes	381651	1.53
832-3DHNQ	246	1	1	Yes	381514	3.6	832-3HSR	348	1	10	Yes	381651	1.53
832-3DHNQ	251	1	1	Yes	381514	3.6	832-3SF	249	1	1	Yes	381668	7.7817
832-3DHNQ	254	1	1	Yes	381514	3.6	832-3SSQ	249	1	1	Yes	381675	11.6387
832-3DHNQ	261	1	1	Yes	381514	3.6	832-3SSR	249	1	1	Yes	381682	9.85
832-3DHNR	246	1	10	Yes	381507	2.685	832-49DF	247	1	1	Yes	310026	8.2494
832-3DHNR	251	1	10	Yes	381507	2.685	832-49DNR	247	1	1	Yes	310033	14.5234
832-3DHNR	254	1	10	Yes	381507	2.685	832-49DSR	247	1	1	Yes	310040	14.9253
832-3DHNR	261	1	10	Yes	381507	2.685	832-4AF	327	1	10	Yes	374660	1.6212
832-3DHSQ	246	1	1	Yes	381620	3.1918	832-4ANQ	327	1	1	Yes	374820	5.0148
832-3DHSQ	251	1	1	Yes	381620	3.1918	832-4ANR	327	1	1	Yes	374745	4.0148
832-3DHSQ	254	1	1	Yes	381620	3.1918	832-4ASQ	327	1	1	Yes	381699	4.7436
832-3DHSQ	261	1	1	Yes	381620	3.1918	832-4ASR	327	1	1	Yes	381705	3.55
832-3DHSR	246	1	1	Yes	381637	2.7	832-4DF	245	1	5	Yes	376084	6.7017
832-3DHSR	251	1	1	Yes	381637	2.7	832-4HIR	245	1	10	Yes	376091	3.3488

Item No	Page No	Min Qty	Case Qty	UPC Bar-Coded	UPC 6-Digit	Weight (lbs.)	Item No	Page No	Min Qty	Case Qty	UPC Bar-Coded	UPC 6-Digit	Weight (lbs.)
832-4DHIR	248	1	10	Yes	376091	3.3488	832-4PNR	328	1	1	Yes	374400	4.1712
832-4DHIR	250	1	10	Yes	376091	3.3488	832-4PSQ	328	1	1	Yes	381750	4.9
832-4DHIR	252	1	10	Yes	376091	3.3488	832-4PSR	328	1	1	Yes	381767	3.75
832-4DHNQ	245	1	10	Yes	376107	4.2546	832-4SF	249	1	1	Yes	381774	7.9015
832-4DHNQ	248	1	10	Yes	376107	4.2546	832-4SHSQ	249	1	1	Yes	381828	4.117
832-4DHNQ	250	1	10	Yes	376107	4.2546	832-4SHSR	249	1	1	Yes	381835	3.878
832-4DHNQ	252	1	10	Yes	376107	4.2546	832-4SSQ	249	1	1	Yes	381842	11.7585
832-4DHNR	245	1	10	Yes	376114	3.3738	832-4SSR	249	1	1	Yes	381859	9.95
832-4DHNR	248	1	10	Yes	376114	3.3738	832-63DF	247	1	1	Yes	306319	7.2966
832-4DHNR	250	1	10	Yes	376114	3.3738	832-63DIR	248	1	1	Yes	306333	10.5602
832-4DHNR	252	1	10	Yes	376114	3.3738	832-63DNQ	248	1	1	Yes	306340	11.5096
832-4DHSQ	245	1	10	Yes	381712	4.208	832-63DNR	248	1	1	Yes	306357	10.3648
832-4DHSQ	248	1	10	Yes	381712	4.208	832-63DSQ	248	1	1	Yes	381866	11.3286
832-4DHSQ	250	1	10	Yes	381712	4.208	832-63DSR	248	1	1	Yes	381873	11.0896
832-4DHSQ	252	1	10	Yes	381712	4.208	832-64DF	247	1	1	Yes	306371	9.0259
832-4DHSR	245	1	10	Yes	381729	3.025	832-64DIR	248	1	1	Yes	306395	12.262
832-4DHSR	248	1	10	Yes	381729	3.025	832-64DNQ	248	1	1	Yes	306418	13.239
832-4DHSR	250	1	10	Yes	381729	3.025	832-64DNR	248	1	1	Yes	306432	12.0941
832-4DHSR	252	1	10	Yes	381729	3.025	832-64DSQ	248	1	1	Yes	381880	13.058
832-4DIR	245	1	1	Yes	376121	10.2662	832-64DSR	248	1	1	Yes	381897	11.93
832-4DNQ	245	1	1	Yes	376138	11.0158	832-6DF	247	1	1	Yes	310057	15.05
832-4DNR	245	1	1	Yes	376145	9.9208	832-6DHR	247	1	1	Yes	310064	5.55
832-4DSQ	245	1	1	Yes	381804	10.9886	832-6DHSR	247	1	1	Yes	310071	5.7615
832-4DSR	245	1	1	Yes	381811	9.85	832-6DNR	247	1	1	Yes	310088	20.45
832-4HHD	327	1	10	Yes	377609	0.9304	832-6DSR	247	1	1	Yes	310095	16.4397
832-4HHD	335	1	10	Yes	377609	0.9304	832-EPS3	329	1	10	Yes	713728	0.9504
832-4HHD	338	1	10	Yes	377609	0.9304	832-EPS3	337	1	10	Yes	713728	0.9504
832-4HHD	340	1	10	Yes	377609	0.9304	832-EPS3	349	1	10	Yes	713728	0.9504
832-4HNQ	327	1	10	Yes	374080	2.7186	832-EX3	329	1	1	Yes	318565	1.5
832-4HNQ	335	1	10	Yes	374080	2.7186	832-EX3	337	1	1	Yes	318565	1.5
832-4HNQ	338	1	10	Yes	374080	2.7186	832-EX3	339	1	1	Yes	318565	1.5
832-4HNQ	340	1	10	Yes	374080	2.7186	832-EX3	342	1	1	Yes	318565	1.5
832-4HNR	327	1	10	Yes	373908	1.85	832-EX3	349	1	1	Yes	318565	1.5
832-4HNR	335	1	10	Yes	373908	1.85	832-EX3	373	1	1	Yes	318565	1.5
832-4HNR	338	1	10	Yes	373908	1.85	832-EX3CQ	246	1	1	Yes	318565	1.5
832-4HNR	340	1	10	Yes	373908	1.85	832-EX3CQ	252	1	1	Yes	318565	1.5
832-4HPR	327	1	10	Yes	711960	0.945	832-EX3CQ	254	1	1	Yes	318565	1.5
832-4HPR	335	1	10	Yes	711960	0.945	832-EX3CQ	262	1	1	Yes	318565	1.5
832-4HPR	338	1	10	Yes	711960	0.945	832-EX4	328	1	1	Yes	374943	1.545
832-4HPR	340	1	10	Yes	711960	0.945	832-EX4	336	1	1	Yes	374943	1.545
832-4HSQ	327	1	1	Yes	381736	2.95	832-EX4	338	1	1	Yes	374943	1.545
832-4HSQ	335	1	1	Yes	381736	2.95	832-EX4	341	1	1	Yes	374943	1.545
832-4HSQ	338	1	1	Yes	381736	2.95	832-EX4	369	1	1	Yes	374943	1.545
832-4HSQ	340	1	1	Yes	381736	2.95	832-EX4CQ	245	1	1	Yes	374943	1.4
832-4HSR	327	1	10	Yes	381743	1.714	832-EX4CQ	248	1	1	Yes	374943	1.4
832-4HSR	335	1	10	Yes	381743	1.714	832-EX4CQ	251	1	1	Yes	374943	1.4
832-4HSR	338	1	10	Yes	381743	1.714	832-EX4CQ	253	1	1	Yes	374943	1.4
832-4HSR	340	1	10	Yes	381743	1.714	832-EX4CQ	297	1	1	Yes	374943	1.4
832-4PF	327	1	10	Yes	374363	1.7776	832-EX4CQ	299	1	1	Yes	374943	1.4
832-4PNQ	327	1	1	Yes	374547	5.1712	832-P	328	1	1	Yes	327871	1.05

Supply

Drainage

Support

Specialties

Appendix

# Numerical Index

Supply

Drainage

Support

Specialties

Appendix

Item No	Page No	Min Qty	Case Qty	UPC Bar-Coded	UPC 6-Digit	Weight (lbs.)	Item No	Page No	Min Qty	Case Qty	UPC Bar-Coded	UPC 6-Digit	Weight (lbs.)
832-P	329	1	1	Yes	327871	1.05	832-UMCQ	245	1	15	Yes	356505	0.85
832-P	336	1	1	Yes	327871	1.05	832-UMCQ	248	1	15	Yes	356505	0.85
832-P	337	1	1	Yes	327871	1.05	832-UMCQ	249	1	15	Yes	356505	0.85
832-P	338	1	1	Yes	327871	1.05	832-UMCQ	251	1	15	Yes	356505	0.85
832-P	339	1	1	Yes	327871	1.05	832-UMCQ	253	1	15	Yes	356505	0.85
832-P	341	1	1	Yes	327871	1.05	832-W	328	10	10	Yes	303349	0.0896
832-P	342	1	1	Yes	327871	1.05	832-W	329	10	10	Yes	303349	0.0896
832-P	349	1	1	Yes	327871	1.05	832-W	336	10	10	Yes	303349	0.0896
832-PCQ	245	1	1	Yes	327871	1.05	832-W	337	10	10	Yes	303349	0.0896
832-PCQ	246	1	1	Yes	327871	1.05	832-W	338	10	10	Yes	303349	0.0896
832-PCQ	247	1	1	Yes	327871	1.05	832-W	339	10	10	Yes	303349	0.0896
832-PCQ	248	1	1	Yes	327871	1.05	832-W	341	10	10	Yes	303349	0.0896
832-PCQ	249	1	1	Yes	327871	1.05	832-W	342	10	10	Yes	303349	0.0896
832-PCQ	251	1	1	Yes	327871	1.05	832-W	349	10	10	Yes	303349	0.0896
832-PCQ	252	1	1	Yes	327871	1.05	832-W	369	10	10	Yes	303349	0.0896
832-PCQ	253	1	1	Yes	327871	1.05	832-W	373	10	10	Yes	303349	0.0896
832-PCQ	254	1	1	Yes	327871	1.05	832-WCQ	245	1	10	Yes	303349	0.0896
832-PCQ	297	1	1	Yes	327871	1.05	832-WCQ	246	1	10	Yes	303349	0.0896
832-PCQ	298	1	1	Yes	327871	1.05	832-WCQ	247	1	10	Yes	303349	0.0896
832-PCQ	299	1	1	Yes	327871	1.05	832-WCQ	248	1	10	Yes	303349	0.0896
832-PCQ	300	1	1	Yes	327871	1.05	832-WCQ	249	1	10	Yes	303349	0.0896
832-S3	329	10	10	Yes	374318	0.0868	832-WCQ	251	1	10	Yes	303349	0.0896
832-S3	337	10	10	Yes	374318	0.0868	832-WCQ	252	1	10	Yes	303349	0.0896
832-S3	339	10	10	Yes	374318	0.0868	832-WCQ	253	1	10	Yes	303349	0.0896
832-S3	342	10	10	Yes	374318	0.0868	832-WCQ	254	1	10	Yes	303349	0.0896
832-S3	349	10	10	Yes	374318	0.0868	832-WCQ	297	1	10	Yes	303349	0.0896
832-S3	373	10	10	Yes	374318	0.0868	832-WCQ	298	1	10	Yes	303349	0.0896
832-S3CQ	246	1	10	Yes	374318	0.0868	832-WCQ	299	1	10	Yes	303349	0.0896
832-S3CQ	252	1	10	Yes	374318	0.0868	832-WCQ	300	1	10	Yes	303349	0.0896
832-S3CQ	254	1	10	Yes	374318	0.0868	833-225DF	251	1	1	Yes	381903	10.8
832-S3CQ	262	1	10	Yes	374318	0.0868	833-225DNQ	251	1	1	Yes	381910	16.2751
832-S4	328	10	10	Yes	373823	0.098	833-225DNR	251	1	1	Yes	381927	15.4
832-S4	336	10	10	Yes	373823	0.098	833-225DSQ	251	1	1	Yes	381934	15.9301
832-S4	338	10	10	Yes	373823	0.098	833-225DSR	251	1	1	Yes	381941	15.04
832-S4	341	10	10	Yes	373823	0.098	833-225F	339	1	1	Yes	381958	8.53
832-S4	369	10	10	Yes	373823	0.098	833-225NQ	339	1	1	Yes	381965	11.042
832-S4CQ	245	1	10	Yes	373823	0.098	833-225NR	339	1	1	Yes	381972	10.337
832-S4CQ	248	1	10	Yes	373823	0.098	833-225SQ	339	1	1	Yes	381989	10.6974
832-S4CQ	249	1	10	Yes	373823	0.098	833-225SR	339	1	1	Yes	381996	10.0974
832-S4CQ	251	1	10	Yes	373823	0.098	833-22DF	250	1	1	Yes	376152	12.738
832-S4CQ	253	1	10	Yes	373823	0.098	833-22DIR	250	1	1	Yes	376169	15.7778
832-S4CQ	297	1	10	Yes	373823	0.098	833-22DNQ	250	1	1	Yes	376176	16.9359
832-S4CQ	299	1	10	Yes	373823	0.098	833-22DNR	250	1	1	Yes	376183	13.95
832-S4CQ	300	1	10	Yes	373823	0.098	833-22DSQ	250	1	1	Yes	382009	16.77
832-SD9	247	1	1	Yes	727602	8.35	833-22DSR	250	1	1	Yes	382016	16.531
832-UM	328	1	15	Yes	356505	0.1536	833-22F	338	1	1	Yes	374851	8.2898
832-UM	332	1	15	Yes	356505	0.1536	833-22NQ	338	1	1	Yes	374868	11.8594
832-UM	336	1	15	Yes	356505	0.1536	833-22NR	338	1	1	Yes	374875	10.8594
832-UM	338	1	15	Yes	356505	0.1536	833-22SQ	338	1	1	Yes	382023	11.5946
832-UM	341	1	15	Yes	356505	0.1536	833-22SR	338	1	1	Yes	382030	8.7

Item No	Page No	Min Qty	Case Qty	UPC Bar-Coded	UPC 6-Digit	Weight (lbs.)	Item No	Page No	Min Qty	Case Qty	UPC Bar-Coded	UPC 6-Digit	Weight (lbs.)
833-235DF	251	1	1	Yes	382047	11.9	833-2PSQ	335	1	1	Yes	382344	5.7392
833-235DNQ	251	1	1	Yes	382054	14.5241	833-2PSR	335	1	1	Yes	382351	4.7198
833-235DNR	251	1	1	Yes	382061	14.3	833-35AF	336	1	1	Yes	382368	2.371
833-235DSQ	251	1	1	Yes	382078	14.1791	833-35ANQ	337	1	1	Yes	382375	5.057
833-235DSR	251	1	1	Yes	382085	14.71	833-35ANR	337	1	1	Yes	382382	4.352
833-235F	339	1	1	Yes	382092	6.9946	833-35ASQ	337	1	1	Yes	382399	4.7116
833-235NQ	339	1	1	Yes	382108	9.291	833-35ASR	337	1	1	Yes	382405	3.9
833-235NR	339	1	1	Yes	382115	8.586	833-35PF	336	1	1	Yes	382412	2.556
833-235SQ	339	1	1	Yes	382122	8.9464	833-35PNQ	337	1	1	Yes	382429	5.242
833-235SR	339	1	1	Yes	382139	9.13	833-35PNR	337	1	1	Yes	382436	4.537
833-23DF	250	1	1	Yes	376190	10.987	833-35PSQ	337	1	1	Yes	382443	4.8966
833-23DIR	250	1	1	Yes	376206	15.2927	833-35PSR	337	1	1	Yes	382450	4.2
833-23DNQ	250	1	1	Yes	376213	14.7	833-3AF	335	1	1	Yes	375100	2.25
833-23DNR	250	1	1	Yes	376220	13.8	833-3ANQ	335	1	1	Yes	375117	7.1736
833-23DSQ	250	1	1	Yes	382146	15.019	833-3ANR	335	1	1	Yes	375124	4.25
833-23DSR	250	1	1	Yes	382153	14.85	833-3ASQ	335	1	1	Yes	382467	5.6191
833-23F	338	1	1	Yes	374905	7.1238	833-3ASR	335	1	1	Yes	382474	4.3
833-23NQ	338	1	1	Yes	374912	10.1084	833-3PF	335	1	10	Yes	373878	2.5721
833-23NR	338	1	1	Yes	374929	9.1084	833-3PNQ	335	1	1	Yes	375070	5.5997
833-23SQ	338	1	1	Yes	382160	9.8436	833-3PNR	335	1	1	Yes	374233	4.3586
833-23SR	338	1	1	Yes	382177	9.57	833-3PSQ	335	1	1	Yes	382481	5.7938
833-24DF	250	1	1	Yes	376237	11.9711	833-3PSR	335	1	1	Yes	382498	4.5
833-24DIR	250	1	1	Yes	376244	15.3883	833-4AF	335	1	10	Yes	375162	5.0604
833-24DNQ	250	1	1	Yes	376251	16.6523	833-4ANQ	335	1	1	Yes	375179	7.2236
833-24DNR	250	1	1	Yes	376268	14.8151	833-4ANR	335	1	1	Yes	375186	6.2236
833-24DSQ	250	1	1	Yes	382184	16.519	833-4ASQ	335	1	1	Yes	382504	5.6588
833-24DSR	250	1	1	Yes	382191	16.28	833-4ASR	335	1	1	Yes	382511	4.633
833-24F	338	1	1	Yes	373885	8.0388	833-4PF	335	1	10	Yes	374356	2.455
833-24NQ	338	1	1	Yes	374950	11.6084	833-4PNQ	335	1	1	Yes	375483	7.3486
833-24NR	338	1	1	Yes	374974	10.6084	833-4PNR	335	1	1	Yes	374240	6.3486
833-24SQ	338	1	1	Yes	382207	11.3436	833-4PSQ	336	1	1	Yes	382528	5.7941
833-24SR	338	1	1	Yes	382214	10.3242	833-4PSR	336	1	1	Yes	382535	4.45
833-25AF	336	1	1	Yes	382221	2.206	833-625DF	254	1	1	Yes	382542	11.2566
833-25ANQ	337	1	1	Yes	382238	4.892	833-625DNQ	254	1	1	Yes	382559	14.7941
833-25ANR	337	1	1	Yes	382245	4.187	833-625DNR	254	1	1	Yes	382566	14.0891
833-25ASQ	337	1	1	Yes	382252	4.5466	833-625DSQ	254	1	1	Yes	382573	14.4491
833-25ASR	337	1	1	Yes	382269	3.82	833-625DSR	254	1	1	Yes	382580	13.8491
833-25PF	336	1	1	Yes	382276	2.491	833-625F	341	1	1	Yes	382597	7.2646
833-25PNQ	337	1	1	Yes	382283	5.177	833-625NQ	342	1	1	Yes	382603	9.561
833-25PNR	337	1	1	Yes	382290	4.472	833-625NR	342	1	1	Yes	382610	8.856
833-25PSQ	337	1	1	Yes	382306	4.8316	833-625SQ	342	1	1	Yes	382627	9.2164
833-25PSR	337	1	1	Yes	382313	4.2316	833-625SR	342	1	1	Yes	382634	8.6164
833-2AF	335	1	10	Yes	375001	2.3317	833-62DF	252	1	1	Yes	376275	10.692
833-2ANQ	335	1	1	Yes	375018	7.0086	833-62DIR	253	1	1	Yes	376282	14.522
833-2ANR	335	1	1	Yes	375025	4.727	833-62DNQ	253	1	1	Yes	376299	14.522
833-2ASQ	335	1	1	Yes	382320	5.4541	833-62DNR	253	1	1	Yes	376305	14.31
833-2ASR	335	1	1	Yes	382337	4.21	833-62DSQ	253	1	1	Yes	382641	15.289
833-2PF	335	1	10	Yes	374325	2.6168	833-62DSR	253	1	1	Yes	382658	15.05
833-2PNQ	335	1	1	Yes	375056	5.585	833-62F	340	1	1	Yes	375230	6.8088
833-2PNR	335	1	1	Yes	365194	4.65	833-62NQ	340	1	1	Yes	375247	10.3784

Supply

Drainage

Support

Specialties

Appendix

# Numerical Index

Supply

Drainage

Support

Specialties

Appendix

Item No	Page No	Min Qty	Case Qty	UPC Bar-Coded	UPC 6-Digit	Weight (lbs.)	Item No	Page No	Min Qty	Case Qty	UPC Bar-Coded	UPC 6-Digit	Weight (lbs.)
833-62NR	340	1	1	Yes	375261	10.9505	834-3HNQ	372	1	1	Yes	315489	2.8354
833-62SQ	340	1	1	Yes	382665	10.1136	834-3HNR	372	1	10	Yes	314727	1.75
833-62SR	340	1	1	Yes	382672	9.0878	834-3HSQ	372	1	1	Yes	315496	2.5054
833-635DF	254	1	1	Yes	382689	12.8266	834-3HSR	372	1	1	Yes	315502	1.7954
833-635DNQ	254	1	1	Yes	304186	16.3641	834-3PF	369	1	10	Yes	374219	1.6894
833-635DNR	254	1	1	Yes	304414	15.315	834-3PNQ	369	1	1	Yes	374622	5.15
833-635DSQ	254	1	1	Yes	304438	16.0191	834-3PNR	369	1	1	Yes	374196	4.4151
833-635DSR	254	1	1	Yes	305206	14.95	834-3PSQ	369	1	1	Yes	307071	5.15
833-635F	341	1	1	Yes	305589	8.8346	834-3PSR	369	1	1	Yes	307088	4.75
833-635NQ	342	1	1	Yes	305596	11.131	834-3SF	300	1	1	Yes	307095	7.8835
833-635NR	342	1	1	Yes	305657	10.426	834-3SSQ	300	1	1	Yes	307125	12.5515
833-635SQ	342	1	1	Yes	305725	10.7473	834-3SSR	300	1	1	Yes	307132	11.7615
833-635SR	342	1	1	Yes	306647	10.1864	834-49DF	298	1	1	Yes	331076	8.2494
833-63DF	252	1	1	Yes	376312	12.262	834-49DIR	298	1	1	Yes	474094	16.8326
833-63DIR	253	1	1	Yes	376329	16.092	834-49DNR	298	1	1	Yes	327734	17.0498
833-63DNQ	253	1	1	Yes	376336	16.8433	834-49DSR	298	1	1	Yes	331243	16.8572
833-63DNR	253	1	1	Yes	376343	15.741	834-4AF	369	1	10	Yes	374691	1.7006
833-63DSQ	253	1	1	Yes	306951	16.859	834-4ANQ	369	1	1	Yes	375414	5.3
833-63DSR	253	1	1	Yes	306968	16.62	834-4ANR	369	1	1	Yes	375421	4.3742
833-63F	340	1	1	Yes	374264	8.3788	834-4ASQ	369	1	1	Yes	307149	5.6528
833-63NQ	340	1	1	Yes	375254	11.9484	834-4ASR	369	1	1	Yes	307156	4.7981
833-63NR	340	1	1	Yes	375285	9.15	834-4DF	297	1	5	Yes	376435	7.0796
833-63SQ	340	1	1	Yes	306975	11.6836	834-4DHIR	297	1	10	Yes	376442	3.5164
833-63SR	340	1	1	Yes	306982	10.6578	834-4DHIR	299	1	10	Yes	376442	3.5164
833-64DF	252	1	1	Yes	376350	12.95	834-4DHNQ	297	1	10	Yes	376459	4.8502
833-64DIR	253	1	1	Yes	376367	16.305	834-4DHNQ	299	1	10	Yes	376459	4.8502
833-64DNQ	253	1	1	Yes	376374	16.7919	834-4DHNR	297	1	10	Yes	376466	3.7
833-64DNR	253	1	1	Yes	376381	15.7924	834-4DHNR	299	1	10	Yes	376466	3.7
833-64DSQ	253	1	1	Yes	306999	17.072	834-4DHSQ	297	1	1	Yes	307163	5.0336
833-64DSR	253	1	1	Yes	307002	16.833	834-4DHSQ	299	1	1	Yes	307163	5.0336
833-64F	340	1	4	Yes	374707	8.8693	834-4DHSR	297	1	1	Yes	307170	4
833-64NQ	340	1	1	Yes	375315	12.1614	834-4DHSR	299	1	1	Yes	307170	4
833-64NR	340	1	1	Yes	374370	11.1614	834-4DIR	297	1	1	Yes	376473	10.494
833-64SQ	340	1	1	Yes	307019	11.8966	834-4DNQ	297	1	1	Yes	376480	11.8168
833-64SR	340	1	1	Yes	307026	10.8772	834-4DNR	297	1	1	Yes	376497	11
834-3AF	369	1	10	Yes	374684	1.5872	834-4DSQ	297	1	1	Yes	307187	11.9371
834-3ANQ	369	1	1	Yes	375346	5.6573	834-4DSR	297	1	1	Yes	307194	8.8881
834-3ANR	369	1	1	Yes	375353	4.2608	834-4HNQ	369	1	10	Yes	374165	3.8571
834-3ASQ	369	1	1	Yes	307033	5.5669	834-4HNR	369	1	10	Yes	373915	2.2846
834-3ASR	369	1	1	Yes	307040	4.6847	834-4HPR	369	1	1	Yes	736055	1.281
834-3DF	297	1	5	Yes	376398	7.1696	834-4HSQ	369	1	10	Yes	307224	3.67
834-3DHNQ	308	1	1	Yes	714206	4.1082	834-4HSR	369	1	10	Yes	307231	2.7085
834-3DHNR	308	1	1	Yes	315687	31.6	834-4PF	369	1	10	Yes	373892	1.9006
834-3DHSQ	308	1	1	Yes	714220	3.7782	834-4PNQ	369	1	1	Yes	375469	5.9707
834-3DHSR	308	1	1	Yes	714213	3.0682	834-4PNR	369	1	1	Yes	365187	4.65
834-3DIR	297	1	1	Yes	376404	10.7071	834-4PSQ	369	1	1	Yes	307248	5.72
834-3DNQ	297	1	1	Yes	376411	12.8062	834-4PSR	369	1	1	Yes	307255	4.3
834-3DNR	297	1	1	Yes	376428	11.1554	834-4SF	300	1	1	Yes	307262	8.0033
834-3DSQ	297	1	1	Yes	307057	12.0314	834-4SHSQ	300	1	1	Yes	307279	4.9513
834-3DSR	297	1	1	Yes	307064	11.2272	834-4SHSR	300	1	1	Yes	307286	3.75

Item No	Page No	Min Qty	Case Qty	UPC Bar-Coded	UPC 6-Digit	Weight (lbs.)	Item No	Page No	Min Qty	Case Qty	UPC Bar-Coded	UPC 6-Digit	Weight (lbs.)
834-4SSQ	300	1	1	Yes	307293	13.5515	835-2	425	1	50	Yes	207814	0.072
834-4SSR	300	1	1	Yes	307323	11.55	835-2	426	1	50	Yes	207814	0.072
834-63DF	298	1	1	Yes	377869	7.4196	835-2	426	1	50	Yes	207814	0.072
834-63DIR	299	1	1	Yes	306944	10.8461	835-2	427	1	50	Yes	207814	0.072
834-63DNQ	299	1	1	Yes	306937	12.3089	835-2	427	1	50	Yes	207814	0.072
834-63DNR	299	1	1	Yes	306920	10.9081	835-2	434	1	50	Yes	207814	0.072
834-63DSQ	299	1	1	Yes	307330	12.2814	835-2	434	1	50	Yes	207814	0.072
834-63DSR	299	1	1	Yes	307347	11.4771	835-2	435	1	50	Yes	207814	0.072
834-64DF	298	1	1	Yes	306913	9.1489	835-2CQ	246	1	50	Yes	207814	0.0014
834-64DIR	299	1	1	Yes	306906	12.5755	835-2CQ	251	1	50	Yes	207814	0.0014
834-64DNQ	299	1	1	Yes	306890	14.0385	835-2CQ	252	1	50	Yes	207814	0.0014
834-64DNR	299	1	1	Yes	306883	12.6375	835-2CQ	253	1	50	Yes	207814	0.0014
834-64DSQ	299	1	1	Yes	307354	14.0108	835-2CQ	254	1	50	Yes	207814	0.0014
834-64DSR	299	1	1	Yes	307361	11.25	835-2CQ	261	1	50	Yes	207814	0.0014
834-6DF	298	1	1	Yes	380715	14.8	835-2CQ	262	1	50	Yes	207814	0.0014
834-6DHIR	298	1	1	Yes	380722	7.65	835-2CQ	267	1	50	Yes	207814	0.0014
834-6DHR	298	1	1	Yes	312419	6.75	835-3	151	1	25	Yes	207784	0.168
834-6DHR	298	1	1	Yes	316288	6.85	835-3	328	1	25	Yes	207784	0.168
834-6DIR	298	1	1	Yes	380739	23	835-3	329	1	25	Yes	207784	0.168
834-6DNR	298	1	1	Yes	312426	18.935	835-3	331	1	25	Yes	207784	0.168
834-6DSR	298	1	1	Yes	310781	0.1	835-3	336	1	25	Yes	207784	0.168
835-2	151	1	50	Yes	207814	0.072	835-3	337	1	25	Yes	207784	0.168
835-2	328	1	50	Yes	207814	0.072	835-3	338	1	25	Yes	207784	0.168
835-2	329	1	50	Yes	207814	0.072	835-3	339	1	25	Yes	207784	0.168
835-2	331	1	50	Yes	207814	0.072	835-3	341	1	25	Yes	207784	0.168
835-2	336	1	50	Yes	207814	0.072	835-3	342	1	25	Yes	207784	0.168
835-2	337	1	50	Yes	207814	0.072	835-3	343	1	25	Yes	207784	0.168
835-2	338	1	50	Yes	207814	0.072	835-3	344	1	25	Yes	207784	0.168
835-2	339	1	50	Yes	207814	0.072	835-3	345	1	25	Yes	207784	0.168
835-2	341	1	50	Yes	207814	0.072	835-3	346	1	25	Yes	207784	0.168
835-2	342	1	50	Yes	207814	0.072	835-3	347	1	25	Yes	207784	0.168
835-2	343	1	50	Yes	207814	0.072	835-3	349	1	25	Yes	207784	0.168
835-2	344	1	50	Yes	207814	0.072	835-3	350	1	25	Yes	207784	0.168
835-2	345	1	50	Yes	207814	0.072	835-3	422	1	25	Yes	207784	0.168
835-2	346	1	50	Yes	207814	0.072	835-3	434	1	25	Yes	207784	0.168
835-2	347	1	50	Yes	207814	0.072	835-3	435	1	25	Yes	207784	0.168
835-2	349	1	50	Yes	207814	0.072	835-35	151	1	25	Yes	207821	0.23
835-2	350	1	50	Yes	207814	0.072	835-35	331	1	25	Yes	207821	0.23
835-2	415	1	50	Yes	207814	0.072	835-35	343	1	25	Yes	207821	0.23
835-2	416	1	50	Yes	207814	0.072	835-35	344	1	25	Yes	207821	0.23
835-2	416	1	50	Yes	207814	0.072	835-35	345	1	25	Yes	207821	0.23
835-2	417	1	50	Yes	207814	0.072	835-35	346	1	25	Yes	207821	0.23
835-2	418	1	50	Yes	207814	0.072	835-35	347	1	25	Yes	207821	0.23
835-2	418	1	50	Yes	207814	0.072	835-35	350	1	25	Yes	207821	0.23
835-2	419	1	50	Yes	207814	0.072	835-35	422	1	25	Yes	207821	0.23
835-2	420	1	50	Yes	207814	0.072	835-35CQ	261	1	25	Yes	207821	0.0092
835-2	421	1	50	Yes	207814	0.072	835-35CQ	267	1	25	Yes	207821	0.0092
835-2	421	1	50	Yes	207814	0.072	835-3CQ	245	1	25	Yes	207784	0.0067
835-2	423	1	50	Yes	207814	0.072	835-3CQ	246	1	25	Yes	207784	0.0067
835-2	424	1	50	Yes	207814	0.072	835-3CQ	248	1	25	Yes	207784	0.0067

Supply

Drainage

Support

Specialties

Appendix

# Numerical Index

Supply

Drainage

Support

Specialties

Appendix

Item No	Page No	Min Qty	Case Qty	UPC Bar-Coded	UPC 6-Digit	Weight (lbs.)	Item No	Page No	Min Qty	Case Qty	UPC Bar-Coded	UPC 6-Digit	Weight (lbs.)
835-3CQ	249	1	25	Yes	207784	0.0067	837-FPAH	318	1	1	Yes	727893	5.116
835-3CQ	251	1	25	Yes	207784	0.0067	837-HBD	316	1	1	No	715883	55.666
835-3CQ	252	1	25	Yes	207784	0.0067	837-HBL	316	1	1	No	715869	44.636
835-3CQ	253	1	25	Yes	207784	0.0067	837-HBR	316	1	1	No	715876	44.636
835-3CQ	254	1	25	Yes	207784	0.0067	837-HSD	315	1	1	No	715821	138.5
835-3CQ	261	1	25	Yes	207784	0.0067	837-HSDW	315	1	1	No	715920	74.5
835-3CQ	262	1	25	Yes	207784	0.0067	837-HSL	315	1	1	No	715807	74.5
835-3CQ	267	1	25	Yes	207784	0.0067	837-HSLW	315	1	1	No	715913	74.5
835-4	151	1	20	Yes	202208	0.2525	837-HSR	315	1	1	No	715814	74.5
835-4	328	1	20	Yes	202208	0.2525	837-HSRW	315	1	1	No	715906	78.3
835-4	331	1	20	Yes	202208	0.2525	837-HXD	315	1	1	No	715852	40.186
835-4	336	1	20	Yes	202208	0.2525	837-HXL	315	1	1	No	715838	29.156
835-4	338	1	20	Yes	202208	0.2525	837-HXR	315	1	1	No	715845	29.156
835-4	341	1	20	Yes	202208	0.2525	837-LEG	318	1	1	Yes	727855	10.95
835-4	343	1	20	Yes	202208	0.2525	837-LEGHL	318	1	1	Yes	727831	-
835-4	344	1	20	Yes	202208	0.2525	837-LEGHR	318	1	1	Yes	727848	-
835-4	345	1	20	Yes	202208	0.2525	837-RA	318	1	35	Yes	727817	1.535
835-4	346	1	20	Yes	202208	0.2525	837-RH	318	1	35	Yes	727824	1.105
835-4	350	1	20	Yes	202208	0.2525	837-TF	318	1	20	Yes	734815	0.43
835-4CQ	245	1	20	Yes	202208	0.0126	837-TR	318	1	15	Yes	727800	2.455
835-4CQ	247	1	20	Yes	202208	0.0126	837-VB10	317	1	1	No	716095	56.724
835-4CQ	248	1	20	Yes	202208	0.0126	837-VB12	317	1	1	No	716132	56.346
835-4CQ	249	1	20	Yes	202208	0.0126	837-VB1L	317	1	1	No	716125	56.724
835-4CQ	251	1	20	Yes	202208	0.0126	837-VB1R	317	1	1	No	716118	56.724
835-4CQ	253	1	20	Yes	202208	0.0126	837-VB20	317	1	1	No	716101	67.574
835-4CQ	267	1	20	Yes	202208	0.0126	837-VB21	317	1	1	No	716149	67.574
836-2	268	1	1	Yes	327703	10.95	837-VB22	317	1	1	No	716156	-
836-3	268	1	1	Yes	327710	9.05	837-VS10	316	1	1	No	715951	74.908
836-4	268	1	1	Yes	327741	11.1	837-VS10W	316	1	1	No	716163	-
836-6	268	1	1	Yes	724946	-	837-VS12	316	1	1	No	715968	74.53
837-06	317	1	1	Yes	726872	0.9	837-VS12W	316	1	1	No	716200	-
837-12	317	1	1	Yes	715890	1.6	837-VS1L	316	1	1	No	715975	74.908
837-7C15	319	1	1	No	725219	30.977	837-VS1LW	316	1	1	No	716187	-
837-7C18	319	1	1	No	725226	30.2	837-VS1R	316	1	1	No	715982	74.908
837-7C22	319	1	1	No	725233	33.003	837-VS1RW	316	1	1	No	716194	-
837-7CA15	319	1	1	No	725240	41.9	837-VS20	316	1	1	No	715999	86.458
837-7CA18	319	1	1	No	725264	43.03	837-VS20W	316	1	1	No	716170	-
837-7CA22	319	1	1	No	725271	43.926	837-VS21	316	1	1	No	716002	85.758
837-7D	320	1	1	No	716330	33.2	837-VS21W	316	1	1	No	716217	-
837-7D2	321	1	1	No	716354	54.1	837-VS22	316	1	1	No	716019	85.38
837-7DC	321	1	1	No	743053	33	837-VS22W	316	1	1	No	716224	-
837-7P	320	1	1	No	716293	24.03	837-VX10	317	1	1	No	716026	41.244
837-7P2	321	1	1	No	716316	32.407	837-VX12	317	1	1	No	716033	40.866
837-7PC	321	1	1	No	743046	24	837-VX1L	317	1	1	No	716040	41.244
837-7PL	319	1	1	No	743039	24	837-VX1R	317	1	1	No	716057	41.244
837-7W	319	1	1	No	716378	5.1	837-VX20	317	1	1	No	716064	52.094
837-7W	320	1	1	No	716378	5.1	837-VX21	317	1	1	No	716071	51.8137
837-7W	321	1	1	No	716378	5.1	837-VX22	317	1	1	No	716088	51.716
837-FH	318	1	30	Yes	727954	0.859	840-20ANR	435	1	10	Yes	300737	0.9172
837-FPA	318	1	1	Yes	727787	38.78	840-20PCQ	435	1	5	Yes	318794	1.2845



Item No	Page No	Min Qty	Case Qty	UPC Bar-Coded	UPC 6-Digit	Weight (lbs.)	Item No	Page No	Min Qty	Case Qty	UPC Bar-Coded	UPC 6-Digit	Weight (lbs.)
840-20PNQ	435	1	1	Yes	318800	0.01	842-36LNQ	331	1	5	Yes	351432	3.1881
840-20PNR	435	1	10	Yes	300768	1.0955	842-36LNR	331	1	10	Yes	306678	2.1383
840-20PRBQ	435	1	5	Yes	318824	2.5334	842-36LP	331	1	1	Yes	352781	1.1576
840-20PSQ	435	1	1	Yes	318817	0.01	842-36LSQ	331	1	1	Yes	307958	3.4732
840-27A	435	20	20	Yes	351579	0.4077	842-36LSR	331	1	10	Yes	307965	1.618
840-27P	435	20	20	Yes	300775	0.4885	842-36PI	330	1	2	Yes	352811	5.8445
840-2A	435	1	20	Yes	300782	0.4077	842-36PNQ	330	1	10	Yes	351364	3.593
840-2APK	435	10	10	Yes	300546	0.447	842-36PNR	330	1	10	Yes	306685	2.397
840-2P	435	20	20	Yes	300799	0.4933	842-36PSQ	330	1	1	Yes	307972	3.4074
840-2PPK	435	10	10	Yes	300508	0.5573	842-36PSR	330	1	10	Yes	307989	2.26
840-30ANR	435	1	10	Yes	352514	0.8518	842-3ANQ	330	1	1	Yes	352866	2.7285
840-30PNR	435	1	10	Yes	300812	1.045	842-3ANR	330	1	8	Yes	352033	1.7938
840-3A	435	1	20	Yes	300836	0.45	842-3ASQ	330	1	1	Yes	307996	2.3835
840-3APK	435	10	10	Yes	300744	0.47	842-3ASR	330	1	1	Yes	308009	1.75
840-3P	435	20	20	Yes	300843	0.5784	842-3LNQ	331	1	5	Yes	305749	2.2517
840-3PPK	435	10	10	Yes	300706	0.6123	842-3LNR	331	1	10	Yes	301123	1.7444
841-29P	434	12	12	Yes	351371	1.1033	842-3LNRPK	331	5	5	Yes	320315	1.842
841-29PNR	434	1	2	Yes	308733	2.225	842-3LP	331	1	10	Yes	301130	0.9321
841-2A	434	12	12	Yes	300201	0.9585	842-3LSQ	331	1	5	Yes	308016	1.9669
841-2ANQ	434	1	1	Yes	308764	2.469	842-3LSR	331	1	10	Yes	308023	1.3095
841-2ANR	434	1	1	Yes	352590	3.1058	842-3PNQ	330	1	10	Yes	305756	2.4245
841-2APK	434	6	6	Yes	300201	0.9727	842-3PNR	330	1	8	Yes	356437	2.1231
841-2ASQ	434	1	1	Yes	308849	2.288	842-3PSQ	330	1	10	Yes	308030	2.605
841-2ASR	434	1	1	Yes	308801	1.159	842-3PSR	330	1	8	Yes	308047	1.9938
841-2P	434	<b>12</b>	12	Yes	300188	1.1835	842-4ANQ	330	1	1	Yes	352934	3.5347
841-2PIR	434	1	1	Yes	308870	2.3158	842-4ANR	330	1	10	Yes	351487	2.3899
841-2PNQ	434	1	1	Yes	308757	3.2652	842-4ASQ	330	1	1	Yes	308054	3.3491
841-2PNR	434	1	6	Yes	351388	3.4524	842-4ASR	330	1	1	Yes	308061	3.1101
841-2PPK	434	6	6	Yes	300188	1.2415	842-4LNQ	331	1	5	Yes	305770	3.079
841-2PSQ	434	1	1	Yes	308832	3.0841	842-4LNR	331	1	10	Yes	305787	2.0603
841-2PSR	434	1	1	Yes	308795	1.9551	842-4LP	331	1	10	Yes	301253	1.0946
841-39P	434	12	12	Yes	351395	1.2133	842-4LSQ	331	1	1	Yes	308078	2.81
842-24I	268	1	2	Yes	351739	4.75	842-4LSR	331	1	10	Yes	308085	2.531
842-2ANQ	330	1	1	Yes	352651	2.6748	842-4PI	330	1	2	Yes	305794	2.725
842-2ANR	330	1	10	Yes	300935	1.49	842-4PNQ	330	1	10	Yes	301284	3.6835
842-2ASQ	330	1	1	Yes	307873	2.3298	842-4PNR	330	1	10	Yes	320421	2.5899
842-2ASR	330	1	1	Yes	307880	1.7251	842-4PSQ	330	1	1	Yes	308092	3.4979
842-2LNQ	331	1	5	Yes	300966	1.5366	842-4PSR	330	1	10	Yes	308122	2.455
842-2LNR	331	1	10	Yes	300973	1.2076	842-712A	458	<b>10</b>	10	Yes	313560	0.165
842-2LP	331	1	10	Yes	300980	0.335	842-712P	458	<b>10</b>	10	Yes	313577	0.205
842-2LSQ	331	1	1	Yes	307897	1.2319	842-82AT	351	1	10	Yes	326287	0.3591
842-2LSR	331	1	1	Yes	307903	0.925	842-82PT	351	1	10	Yes	326263	0.4551
842-2PNQ	330	1	10	Yes	301024	2.47	842-83AT	351	1	10	Yes	351715	0.7423
842-2PNR	330	1	10	Yes	356420	2.0768	842-83PT	351	1	10	Yes	326362	0.895
842-2PSQ	330	1	10	Yes	307910	2.585	842-84AT	351	1	10	Yes	353030	1.016
842-2PSR	330	1	10	Yes	307927	1.8368	842-84PT	351	1	10	Yes	326461	1.3204
842-36ANQ	330	1	1	Yes	352736	3.4213	842-SCS2	350	1	1	Yes	309891	0.9153
842-36ANR	330	1	1	Yes	351630	2.2253	842-SCS3	350	1	10	Yes	309884	1.4653
842-36ASQ	330	1	1	Yes	307934	3.2357	842-SCS4	350	1	10	Yes	309402	0.845
842-36ASR	330	1	1	Yes	307941	2.9455	842-SCSQ2	350	1	1	Yes	309877	0.9543

Supply

Drainage

Support

Specialties

Appendix

# Numerical Index

Supply

Drainage

Support

Specialties

Appendix

Item No	Page No	Min Qty	Case Qty	UPC Bar-Coded	UPC 6-Digit	Weight (lbs.)	Item No	Page No	Min Qty	Case Qty	UPC Bar-Coded	UPC 6-Digit	Weight (lbs.)
842-SCSQ3	350	1	1	Yes	309860	2.2259	844-OSL	437	1	1	Yes	344229	5.1
842-SCSQ4	350	1	1	Yes	309853	3.2112	844-S4	438	1	40	Yes	301703	1.185
842-SD4	350	1	1	Yes	310958	0.95	845-2APK	436	10	10	Yes	301321	0.0664
842-SI3	350	1	10	Yes	353061	2.3248	845-2PPK	436	10	10	Yes	301307	0.0684
842-SI4	350	1	2	Yes	351845	3.1134	845-3APK	436	10	10	Yes	301369	0.135
842-SN2	350	1	20	Yes	353078	0.2575	845-3PPK	436	10	10	Yes	301345	0.1436
842-SN3	350	1	10	Yes	301451	1.1021	845-4APK	436	10	10	Yes	301406	0.189
842-SN4	350	1	20	Yes	301468	0.8375	845-4PPK	436	10	10	Yes	301383	0.2378
842-SNQ2	350	1	1	Yes	309846	0.0001	845-83PN	436	10	10	Yes	740854	-
842-SNQ3	350	1	1	Yes	309839	2.1007	845-84PN	436	10	10	Yes	740861	-
842-SNQ4	350	1	20	Yes	376039	1.2515	846-S11PK	439	3	3	Yes	306425	1.768
842-SP2	350	1	1	Yes	353085	0.2725	846-S13PK	439	3	3	Yes	306449	1.9183
842-SP3	350	1	10	Yes	353092	0.4071	846-S15PK	439	3	3	Yes	306463	1.6567
842-SP4	350	1	10	Yes	353108	0.34	846-S17PK	439	3	3	Yes	306562	2.25
842-SS2	350	1	10	Yes	353115	0.261	846-S19PK	439	3	3	Yes	306661	2.967
842-SS3	350	1	10	Yes	353122	0.3147	846-S1PK	439	3	3	Yes	306302	0.765
842-SS4	350	1	10	Yes	351883	0.2942	846-S3PK	439	3	3	Yes	306326	0.9357
842-UM	331	1	10	Yes	308139	0.1815	846-S5PK	439	3	3	Yes	306364	1.271
842-UM	343	1	10	Yes	308139	0.1815	846-S7PK	439	3	3	Yes	306388	1.517
842-UM	345	1	10	Yes	308139	0.1815	846-S9PK	439	3	3	Yes	306401	1.6
842-UM	346	1	10	Yes	308139	0.1815	847-2	436	20	20	No	339256	0.155
843-2ANQ	332	1	1	Yes	353160	1.8452	847-2PK1	436	5	5	Yes	301222	0.422
843-2ANR	332	1	10	Yes	306098	1.2974	847-3	436	20	20	No	306692	0.1996
843-2AP	332	1	1	Yes	353177	0.6557	847-3PK1	436	10	10	Yes	301239	0.4539
843-2AS	332	1	10	Yes	353184	0.6126	847-4	436	10	10	No	301819	0.325
843-2PNQ	332	1	5	Yes	301499	1.7471	847-4PK1	436	10	10	Yes	301246	0.5931
843-2PNR	332	1	10	Yes	305817	1.3726	847-7	436	10	10	Yes	301277	0.9919
843-2PP	332	1	1	Yes	301512	0.7757	847-7B	436	20	20	Yes	306111	0.9393
843-2PS	332	1	10	Yes	305824	0.6928	847-9	436	1	10	Yes	301291	2.1433
843-3ANQ	332	1	10	Yes	353245	2.4011	850-234N	375	1	10	Yes	351968	4.1516
843-3ANR	332	1	1	Yes	353252	1.7054	850-21	375	1	6	Yes	301475	7.0343
843-3AP	332	1	10	Yes	351876	0.8604	850-2N	375	1	6	Yes	301871	4.4304
843-3AS	332	1	1	Yes	353269	0.731	850-2T	375	1	6	Yes	301888	1.6904
843-3PNQ	332	1	10	Yes	351951	2.5261	850-3I	375	1	4	Yes	301895	9.5375
843-3PNR	332	1	10	Yes	305831	1.8304	850-3N	375	1	6	Yes	301901	7.3549
843-3PP	332	1	10	Yes	305848	0.9914	850-3T	375	1	6	Yes	301918	2.6969
843-3PS	332	1	10	Yes	306807	0.745	850-4I	375	1	2	Yes	305855	12.7947
843-4ANQ	332	1	1	Yes	353320	3.0459	850-4IN	375	1	2	Yes	353443	15.575
843-4ANR	332	1	4	Yes	353337	2.0176	850-4N	375	1	6	Yes	306074	9.8086
843-4AS	332	1	1	Yes	353351	0.7497	850-4T	375	1	6	Yes	305862	3.4826
843-4PNQ	332	1	10	Yes	351906	3.1124	850-9I	307	1	1	Yes	712165	44.35
843-4PNR	332	1	4	Yes	301581	2.1126	850-9IN	307	1	1	Yes	712172	47.55
843-4PP	332	1	1	Yes	301598	1.197	850-CI2	382	1	1	Yes	353467	2.2082
843-4PS	332	1	4	Yes	306784	0.8897	850-CI3	382	1	1	Yes	353474	3.175
844-02G	438	1	10	Yes	301611	1.2747	850-CI4	382	1	1	Yes	353481	5.1484
844-02SL	437	1	1	Yes	344212	2.05	850-CN2	381	1	10	Yes	353498	1.7564
844-04G	438	1	10	Yes	301635	3.075	850-CN3	381	1	10	Yes	351975	2.0144
844-04IQ	437	1	4	Yes	344120	8.4625	850-CN4	381	1	1	Yes	353504	3.75
844-04SL	437	1	1	Yes	344236	9.9125	850-CT2	381	1	10	Yes	353511	0.71
844-0G	438	1	10	Yes	301659	1.54	850-CT3	381	1	10	Yes	301956	0.7085

Item No	Page No	Min Qty	Case Qty	UPC Bar-Coded	UPC 6-Digit	Weight (lbs.)	Item No	Page No	Min Qty	Case Qty	UPC Bar-Coded	UPC 6-Digit	Weight (lbs.)
850-CT4	381	1	10	Yes	353528	1.2993	852-3ANR	370	1	5	Yes	350343	2.7633
850-V105	352	1	25	Yes	314673	0.0487	852-3ASQ	370	1	1	Yes	308153	4.214
850-V106	352	1	25	Yes	314659	0.0585	852-3ASR	370	1	5	Yes	308160	3.29
850-V109	352	1	1	Yes	314642	0.1837	852-3LI	371	2	2	Yes	351784	4.2123
850-V407	352	1	1	Yes	314635	0.0103	852-3LNQ	370	1	5	Yes	351791	2.9909
850-V415	352	1	1	Yes	314628	0.0153	852-3LNR	370	1	10	Yes	302182	1.928
850-V425	352	1	1	Yes	314611	0.0278	852-3LP	371	1	10	Yes	354372	1.0551
850-VW1	352	10	100	Yes	351920	0.0351	852-3LSQ	371	1	1	Yes	308177	2.6699
850-VW4	352	10	10	Yes	353535	0.0451	852-3LSR	371	1	10	Yes	308184	1.9208
851-24I	306	1	2	Yes	305879	11.8315	852-3PI	370	2	2	Yes	350695	2.9593
851-24N	306	1	2	Yes	351944	8.5491	852-3PNQ	370	1	2	Yes	350725	4.4178
851-24T	306	1	2	Yes	353627	6.1907	852-3PNR	370	1	5	Yes	350329	2.935
851-33N	374	1	2	Yes	353702	3.0961	852-3PSQ	370	1	1	Yes	308191	4.3857
851-33T	374	1	2	Yes	353719	1.4622	852-3PSR	370	1	1	Yes	308221	3.38
851-34I	374	1	2	Yes	305886	8.3135	852-4AI	370	1	1	Yes	350749	2.9872
851-34N	374	1	2	Yes	305893	5.0168	852-4ANQ	370	1	1	Yes	354426	4.4062
851-34T	374	1	2	Yes	306722	2.6568	852-4ANR	370	1	10	Yes	350442	2.8865
851-36I	374	1	2	Yes	353740	14.4978	852-4ASQ	370	1	1	Yes	308238	4.3741
851-36IN	374	1	2	Yes	353757	18.3759	852-4ASR	370	1	1	Yes	308245	3.4509
851-36N	374	1	2	Yes	353771	8.2747	852-4LI	371	2	2	Yes	305961	5.2625
851-36T	374	1	2	Yes	353788	4.6474	852-4LNQ	370	1	1	Yes	302274	3.7997
851-43N	374	1	2	Yes	305909	3.1681	852-4LNR	370	1	10	Yes	302281	2.4886
851-43T	374	1	2	Yes	302014	1.5542	852-4LNRPK	370	5	5	Yes	350411	2.5328
851-44I	374	1	2	Yes	305916	8.2555	852-4LP	371	1	1	Yes	350763	1.3668
851-44N	374	1	2	Yes	302038	4.1	852-4LSQ	371	1	1	Yes	308252	0.7232
851-44T	374	1	2	Yes	356512	2.5988	852-4LSR	371	1	1	Yes	308269	2.9535
851-46I	374	1	2	Yes	302052	15.7781	852-4PI	370	2	2	Yes	305992	3.4
851-46IN	374	1	2	Yes	351692	19.7099	852-4PNQ	370	1	2	Yes	306036	4.6062
851-46N	374	1	2	Yes	302069	9.6087	852-4PNR	370	1	10	Yes	350428	3.4765
851-46T	374	1	2	Yes	306746	4.5875	852-4PSQ	370	1	2	Yes	308276	4.65
851-64I	306	1	2	Yes	351708	11.3494	852-4PSR	370	1	10	Yes	308283	3.525
851-64N	306	1	2	Yes	351746	8.0901	852-CD4	382	1	10	Yes	321183	1.2436
851-64T	306	1	2	Yes	353900	5.7301	852-CI3	382	1	1	Yes	354549	2.3
851-66I	306	1	2	Yes	351814	24.1451	852-CI4	382	1	5	Yes	354556	3.65
851-66N	306	1	2	Yes	353931	15.972	852-CN2	381	1	10	Yes	354563	1.279
851-66T	306	1	2	Yes	353948	13.8785	852-CN3	381	1	10	Yes	354570	1.4809
851-CI4	382	1	1	Yes	353962	2.23	852-CN4	381	1	10	Yes	350794	1.8551
851-CI6	382	1	10	Yes	353979	3.5811	852-CP3	382	1	1	Yes	354594	0.5809
851-CI8	382	1	10	Yes	353986	5.1911	852-CP4	382	1	1	Yes	354600	0.8051
851-CN3	381	1	10	Yes	351838	1.167	852-CS3	382	1	1	Yes	316882	1.9063
851-CN4	381	1	10	Yes	351654	1.7513	852-CS4	382	1	1	Yes	316899	2.877
851-CN6	381	1	10	Yes	353993	3.0811	852-CT4	381	1	2	Yes	354631	0.8651
851-CN8	381	1	10	Yes	354006	3.9011	852-HCD4	382	1	1	Yes	325914	2.66
851-CT3	381	1	10	Yes	302113	0.427	852-HCN4	381	1	1	Yes	325921	3.2242
851-CT4	381	1	10	Yes	354013	0.6522	853-F23I	309	1	27	Yes	718341	1.53
851-CT6	381	1	10	Yes	351760	1.1811	853-F24I	309	1	16	Yes	718358	2.674
851-CT8	381	1	10	Yes	354020	1.3111	853-F26I	309	1	4	Yes	718365	7.165
852-2LNR	370	1	10	Yes	302168	1.2355	853-T23I	309	1	6	Yes	718389	5.478
852-3AI	370	1	1	Yes	354280	2.7876	853-T24I	309	1	4	Yes	718396	9.75
852-3ANQ	370	1	1	Yes	354297	4.2461	853-T26I	309	1	1	Yes	718402	22.226

Supply

Drainage

Support

Specialties

Appendix

# Numerical Index

Supply

Drainage

Support

Specialties

Appendix

Item No	Page No	Min Qty	Case Qty	UPC Bar-Coded	UPC 6-Digit	Weight (lbs.)	Item No	Page No	Min Qty	Case Qty	UPC Bar-Coded	UPC 6-Digit	Weight (lbs.)
853-T28I	309	1	1	Yes	718419	35.724	858-PG3CQ	253	1	20	Yes	317810	0.325
854-23I	302	1	1	No	718792	10.995	858-PG3CQ	254	1	20	Yes	317810	0.325
854-23IN	302	1	1	No	718846	11.785	858-PG4	341	1	20	Yes	312006	0.107
854-23INQ	302	1	1	No	718976	11.86	858-PG4CQ	248	1	20	Yes	312006	0.107
854-23IQ	302	1	1	No	718945	8.445	858-PG4CQ	253	1	20	Yes	312006	0.107
854-23IS	303	1	1	No	718891	-	860-22I	263	1	1	Yes	306876	30.65
854-23NQ	301	1	1	No	735959	10.505	860-22N	263	1	1	Yes	306869	26.05
854-23NR	301	1	1	No	727411	10	860-22Z	263	1	1	Yes	369987	26.3015
854-23SR	301	1	1	No	727466	10.745	860-23I	263	1	1	Yes	306845	28.318
854-24I	302	1	1	No	718808	11.395	860-23N	263	1	1	Yes	306838	24.5983
854-24IN	302	1	1	No	718853	12.185	860-23Z	263	1	1	Yes	369994	24.8498
854-24INQ	302	1	1	No	718983	12.26	860-24I	263	1	1	Yes	306814	29.05
854-24IQ	302	1	1	No	718952	-	860-24N	263	1	1	Yes	306777	27.35
854-24IS	303	1	1	No	718907	12.185	860-24Z	263	1	1	Yes	370006	24.75
854-24NQ	301	1	1	No	727442	10.905	860-26I	263	1	1	Yes	306630	30.2867
854-24NR	301	1	1	No	727428	10	860-26N	263	1	1	Yes	306623	30.9
854-24SR	301	1	1	No	727473	11.145	860-26Z	263	1	1	Yes	369840	26.385
854-26I	302	1	1	No	718815	28.05	860-2A	333	1	1	Yes	354655	4.2296
854-26IN	302	1	1	No	718860	30	860-2AI	333	1	1	Yes	354662	15.3775
854-26IS	303	1	1	No	718914	32	860-2AN	333	1	1	Yes	354679	8.965
854-28I	302	1	1	No	718822	31.2754	860-2AZ	333	1	1	Yes	370143	9.2165
854-28IN	302	1	1	No	718877	14.057	860-2P	333	1	4	Yes	350817	5.5076
854-28IS	303	1	1	No	718921	14.057	860-2PI	333	1	1	Yes	354693	14.4
854-63I	304	1	1	No	719003	12.48	860-2PN	333	1	1	Yes	302380	9.1875
854-63IN	305	1	1	No	719058	13.27	860-2PZ	333	1	4	Yes	371256	9.5915
854-63INQ	305	1	1	No	719188	-	860-3A	333	1	4	Yes	350855	3.9296
854-63IQ	304	1	1	No	719157	-	860-3AI	333	1	2	Yes	350862	15.0775
854-63IS	305	1	1	No	719102	-	860-3AN	333	1	1	Yes	354709	8.315
854-63NQ	303	1	1	No	727527	12.555	860-3AZ	333	1	1	Yes	370099	8.5665
854-63NR	303	1	1	No	727497	12.535	860-3P	333	1	4	Yes	337030	5.108
854-63SR	304	1	1	No	727558	12.795	860-3PI	333	1	2	Yes	305626	15.0905
854-64I	304	1	1	No	719010	13.12	860-3PN	333	1	4	Yes	305114	9.04
854-64IN	305	1	1	No	719065	29.2044	860-3PZ	333	1	4	Yes	370129	9.125
854-64INQ	305	1	1	No	719195	-	860-3SS	265	1	1	Yes	308290	7.15
854-64IQ	304	1	1	No	719164	-	860-3SS	280	1	1	Yes	308290	7.15
854-64IS	305	1	1	No	719119	-	860-3SSS	265	1	1	No	314246	2.3662
854-64NQ	303	1	1	No	727534	13.195	860-3SSS	280	1	1	No	314246	2.3662
854-64NR	303	1	1	No	727503	13.175	860-4A	333	1	1	Yes	354723	3.9246
854-64SR	304	1	1	No	727565	13.435	860-4AI	333	1	1	Yes	354730	14.9025
854-66I	304	1	1	No	719027	28.1377	860-4AN	333	1	1	Yes	354747	8.66
854-66IN	305	1	1	No	719072	31.2277	860-4AZ	333	1	4	Yes	369956	8.9115
854-66IS	305	1	1	No	719126	14.7577	860-4P	333	1	4	Yes	352262	5.0626
854-68I	304	1	1	No	719034	35	860-4PI	333	1	2	Yes	352279	15.7025
854-68IN	305	1	1	No	719089	17.407	860-4PN	333	1	4	Yes	306753	8.995
854-68IS	305	1	1	No	719133	17.407	860-4PZ	333	1	4	Yes	369949	9.2465
858-63L	268	1	4	Yes	350923	4.334	860-4SS	265	1	1	Yes	375728	11.9
858-64L	268	1	4	Yes	302366	4.3038	860-4SS	280	1	1	Yes	375728	11.9
858-PG3	341	1	20	Yes	317810	0.325	860-4SSS	265	1	1	Yes	376572	5.6629
858-PG3	342	1	20	Yes	317810	0.325	860-4SSS	280	1	1	Yes	376572	5.6629
858-PG3CQ	248	1	20	Yes	317810	0.325	860-4SSU	265	1	1	Yes	314178	1.45

Item No	Page No	Min Qty	Case Qty	UPC Bar-Coded	UPC 6-Digit	Weight (lbs.)	Item No	Page No	Min Qty	Case Qty	UPC Bar-Coded	UPC 6-Digit	Weight (lbs.)
860-4SSU	280	1	1	Yes	314178	1.45	860-Q266IN	265	1	1	No	725769	62.204
860-6	334	1	10	Yes	354761	0.2697	860-R222I	264	1	1	No	718235	34.58
860-62I	264	1	1	Yes	306609	30.3483	860-R222IN	264	1	1	No	725783	-
860-62N	263	1	1	Yes	306593	24.8683	860-R223I	264	1	1	No	718242	37.92
860-62Z	264	1	1	Yes	369659	25.1198	860-R223IN	264	1	1	No	725790	-
860-63I	264	1	1	Yes	306579	28.533	860-R224I	264	1	1	No	718259	35.97
860-63N	263	1	1	Yes	306555	26.573	860-R224IN	264	1	1	No	725806	40.525
860-63Z	264	1	1	Yes	369635	26.7545	860-R226I	264	1	1	No	718266	34.495
860-64I	264	1	1	Yes	306531	28.3	860-R226IN	264	1	1	No	725813	42.285
860-64N	263	1	1	Yes	306524	25.9637	860-R228I	264	1	1	No	718273	35.011
860-64Z	264	1	1	Yes	369628	26.9248	860-R228IN	264	1	1	No	725820	41.041
860-6A	333	1	1	Yes	354778	5.9146	860-R262I	265	1	1	No	718280	33.966
860-6AI	333	1	1	Yes	354785	15.3825	860-R262IN	265	1	1	No	726834	-
860-6AN	333	1	1	Yes	354792	10.3	860-R263I	265	1	1	No	718297	35.399
860-6AZ	333	1	1	Yes	369970	10.7215	860-R263IN	265	1	1	No	725837	-
860-6P	333	1	1	Yes	350510	7.936	860-R264I	265	1	1	No	718303	35.619
860-6PI	333	1	2	Yes	350527	18.6875	860-R264IN	265	1	1	No	725844	43.189
860-6PN	333	1	1	Yes	354815	11.6244	860-R266I	265	1	1	No	718310	37.934
860-6PZ	333	1	1	Yes	369963	11.8759	860-R266IN	265	1	1	No	725851	-
860-C	334	1	10	Yes	350534	0.7882	860-RGN	334	1	1	Yes	350572	6.096
860-C	358	1	10	Yes	350534	0.7882	860-RGN	357	1	1	Yes	350572	6.096
860-CI	334	1	10	Yes	369611	3.3416	860-RGN2	334	1	1	Yes	350589	5.13
860-D	334	1	80	Yes	305695	0.282	860-RGN2	357	1	1	Yes	350589	5.13
860-GA	334	1	12	Yes	350541	1.3883	860-RGS	334	1	1	Yes	310644	6.096
860-GA2	334	1	1	Yes	354839	0.6435	860-RGS	357	1	1	Yes	310644	6.096
860-GI	334	1	5	Yes	350558	9.4931	860-RGS2	334	1	1	Yes	310651	5.13
860-GI	357	1	5	Yes	350558	9.4931	860-RGS2	357	1	1	Yes	310651	5.13
860-GN2	334	1	1	Yes	302557	3.88	860-S	334	1	20	Yes	302786	1.033
860-GN2	357	1	1	Yes	302557	3.88	860-U	334	1	20	Yes	302618	0.858
860-GN3	357	1	1	Yes	305497	4.68	860-UM	334	1	5	Yes	304834	0.41
860-GP	334	1	16	Yes	302571	1.8451	860-UM	358	1	5	Yes	304834	0.41
860-GP2	334	1	10	Yes	304995	1.283	860-W2P	357	1	4	Yes	316370	5.4938
860-GPJ	334	1	16	Yes	305480	1.6194	860-W2PI	357	1	1	Yes	315991	16.2925
860-Q222I	264	1	1	No	723758	48.66	860-W2PN	357	1	1	Yes	316387	10.4284
860-Q222IN	264	1	1	No	725684	-	860-W2PX	357	1	4	Yes	316394	4.7384
860-Q223I	264	1	1	No	723765	50.24	860-W2PZ	357	1	1	Yes	316028	10.6799
860-Q223IN	264	1	1	No	726841	58.67	860-W3P	357	1	4	Yes	315908	5.1713
860-Q224I	264	1	1	No	723772	50.05	860-W3PI	357	1	2	Yes	316004	15.3
860-Q224IN	264	1	1	No	725707	56.72	860-W3PN	357	1	4	Yes	316363	8.6
860-Q226I	264	1	1	No	723789	50.335	860-W3PX	357	1	4	Yes	316332	3.39
860-Q226IN	264	1	1	No	725714	-	860-W3PZ	357	1	1	Yes	316035	9.3351
860-Q228I	264	1	1	No	723796	49.091	860-W4P	357	1	4	Yes	316356	5.2
860-Q228IN	264	1	1	No	725721	57.521	860-W4PI	357	1	2	Yes	316011	15.35
860-Q262I	265	1	1	No	723802	48.046	860-W4PN	357	1	4	Yes	315984	8.9875
860-Q262IN	265	1	1	No	725738	56	860-W4PX	357	1	4	Yes	316349	3.305
860-Q263I	265	1	1	No	726858	49.479	860-WGP	357	1	16	Yes	316059	1.8314
860-Q263IN	265	1	1	No	725745	61.2	860-WGP2	357	1	10	Yes	316066	1.3
860-Q264I	265	1	1	No	723819	49.699	860-WGP3	357	1	10	Yes	316073	1.61
860-Q264IN	265	1	1	No	725752	64	860-WGPJ	357	1	16	Yes	316080	2.1062
860-Q266I	265	1	1	No	723840	52.014	860-WS	358	1	20	Yes	316097	1.006

Supply

Drainage

Support

Specialties

Appendix

# Numerical Index

Supply

Drainage

Support

Specialties

Appendix

Item No	Page No	Min Qty	Case Qty	UPC Bar-Coded	UPC 6-Digit	Weight (lbs.)	Item No	Page No	Min Qty	Case Qty	UPC Bar-Coded	UPC 6-Digit	Weight (lbs.)
860-WU	358	1	20	Yes	316103	0.84	861-CQ8	276	8	8	Yes	719805	3.38
861-2P	355	1	1	Yes	350701	7.0593	861-CR2	277	1	1	No	719812	3.06
861-2PI	355	1	1	Yes	354860	16.3867	861-CR8	278	1	1	No	719829	4.6
861-2PN	355	1	1	Yes	354877	15.5067	861-D	356	1	80	Yes	302885	0.282
861-2PR	355	1	1	Yes	713933	8.8777	861-D	358	1	80	Yes	302885	0.282
861-2PX	355	1	3	Yes	305527	5.3067	861-GAQ2F	273	1	6	No	719836	0.7167
861-2PXR	355	1	3	Yes	708472	5.8933	861-GAQ2F	274	1	6	No	719836	0.7167
861-2PZ	355	1	1	Yes	316479	16.2	861-GAQ2F	275	1	6	No	719836	0.7167
861-3P	355	1	1	Yes	302670	7.6896	861-GAQ2H	273	1	6	No	719843	3.172
861-3PI	355	1	1	Yes	354884	16.1	861-GAQ2H	274	1	6	No	719843	3.172
861-3PN	355	1	1	Yes	302731	15.6	861-GAQ2H	275	1	6	No	719843	3.172
861-3PR	355	1	1	Yes	713940	9.5795	861-GAQ2T	273	1	6	No	719850	4.092
861-3PX	355	1	3	Yes	305534	5.3467	861-GAQ2T	274	1	6	No	719850	4.092
861-3PXR	355	1	3	Yes	708205	6.5951	861-GAQ2T	275	1	6	No	719850	4.092
861-3PZ	355	1	1	Yes	316486	16.637	861-GAQ8F	276	1	6	No	719867	3.069
861-4P	355	1	1	Yes	350503	8.9043	861-GAQ8H	276	1	6	No	719874	2.455
861-4PI	355	1	1	Yes	354891	16.2659	861-GAQ8T	276	1	6	No	719881	2.906
861-4PN	355	1	1	Yes	354907	16.8404	861-GAR2F	277	1	6	No	719898	6.35
861-4PX	355	1	3	Yes	305541	5.3917	861-GAR2H	277	1	6	No	719904	4.092
861-4PZ	355	1	1	Yes	316493	-	861-GAR8F	278	1	6	No	719928	2.906
861-5	356	1	15	Yes	305558	1.846	861-GAR8H	278	1	6	No	719935	1.842
861-51	356	1	15	Yes	305602	1.1873	861-GKQ2F	279	1	1	Yes	744272	3
861-51AR	356	1	10	Yes	735904	1.65	861-GKQ2FL	279	1	1	Yes	744296	4.5
861-51NR	356	1	3	Yes	350626	8.333	861-GKQ2FW	279	1	1	Yes	744302	6
861-51SR	356	1	3	Yes	316523	8.8	861-GKQ2H	279	1	1	Yes	744319	1.5
861-53	356	1	15	Yes	305619	1.4633	861-GNQ2F	273	1	1	No	719959	8.443
861-53N	356	1	1	Yes	302809	6.08	861-GNQ2F	274	1	1	No	719959	8.443
861-53NR	356	1	3	Yes	354914	9.4	861-GNQ2F	275	1	1	No	719959	8.443
861-5AR	356	1	10	Yes	735898	2.15	861-GNQ2H	273	1	1	No	719966	5.234
861-5CI	356	1	3	Yes	350633	10.5211	861-GNQ2H	274	1	1	No	719966	5.234
861-5NR	356	1	3	Yes	302847	10.5211	861-GNQ2H	275	1	1	No	719966	5.234
861-5SR	356	1	1	Yes	316516	10.7	861-GNQ2T	273	1	1	No	719973	6.763
861-6	356	1	10	Yes	305565	0.2666	861-GNQ2T	274	1	1	No	719973	6.763
861-6	358	1	10	Yes	305565	0.2666	861-GNQ2T	275	1	1	No	719973	6.763
861-6P	355	1	1	Yes	354921	8.2288	861-GNQ8F	276	1	1	No	719980	4.324
861-6PI	355	1	1	Yes	354938	16.2224	861-GNQ8H	276	1	1	No	719997	3.061
861-6PN	355	1	1	Yes	354945	16.2224	861-GNQ8T	276	1	1	No	720009	3.704
861-6PX	355	1	2	Yes	302861	4.7615	861-GNR2F	277	1	1	No	720016	7.755
861-6PZ	355	1	1	Yes	316509	16.713	861-GNR2H	277	1	1	No	720023	5.6
861-BKQ2	279	1	1	Yes	744401	2	861-GNR2T	277	1	1	No	720030	6.751
861-BQ2	273	1	1	No	719751	4.53	861-GNR8F	278	1	1	No	720047	3.15
861-BQ2	274	1	1	No	719751	4.53	861-GNR8H	278	1	1	No	720054	2.4
861-BQ2	275	1	1	No	719751	4.53	861-Q2221	275	1	1	No	720078	35.65
861-BQ8	276	1	1	No	719768	1.6	861-Q2221A	275	1	1	No	720085	35.65
861-BR2	277	1	1	No	719775	3.42	861-Q2221N	275	1	1	No	720092	44.093
861-BR8	278	1	1	No	719782	1.19	861-Q2226	273	1	1	No	720108	20.565
861-C	356	1	5	Yes	374790	0.7252	861-Q2226A	273	1	1	No	720115	26
861-CQ2	273	1	1	No	719799	7.76	861-Q2226N	273	1	1	No	720122	29.008
861-CQ2	274	1	1	No	719799	7.76	861-Q2228	274	1	1	No	720139	23.02
861-CQ2	275	1	1	No	719799	7.76	861-Q2228A	274	1	1	No	720146	23.02

Item No	Page No	Min Qty	Case Qty	UPC Bar-Coded	UPC 6-Digit	Weight (lbs.)	Item No	Page No	Min Qty	Case Qty	UPC Bar-Coded	UPC 6-Digit	Weight (lbs.)
861-Q2228N	274	1	1	No	720153	8.443	861-QF2386A	276	1	1	No	721013	20.769
861-Q2286	276	1	1	No	720160	14.017	861-QF2386N	276	1	1	No	721020	25.3
861-Q2286A	276	1	1	No	720177	-	861-QF2421	275	1	1	No	721037	38.1
861-Q2286N	276	1	1	No	720184	-	861-QF2421A	275	1	1	No	721044	36.321
861-Q2321	275	1	1	No	720191	29.159	861-QF2421N	275	1	1	No	721051	56
861-Q2321A	275	1	1	No	720207	36.914	861-QF2426	273	1	1	No	721068	31.205
861-Q2321N	275	1	1	No	720214	37.602	861-QF2426A	273	1	1	No	721075	31.9217
861-Q2326	273	1	1	No	720221	20.565	861-QF2426N	273	1	1	No	721082	37.5
861-Q2326A	273	1	1	No	720238	26	861-QF2428	274	1	1	No	721099	31.205
861-Q2326N	273	1	1	No	720245	29.1	861-QF2428A	274	1	1	No	721105	31.9217
861-Q2328	274	1	1	No	720252	23.02	861-QF2428N	274	1	1	No	721112	8.443
861-Q2328A	274	1	1	No	720269	23.7367	861-QF2486	276	1	1	No	721129	18.8
861-Q2328N	274	1	1	No	720276	31.463	861-QF2486A	276	1	1	No	721136	18.8
861-Q2386	276	1	1	No	720283	12.8	861-QF2486N	276	1	1	No	721143	24
861-Q2386A	276	1	1	No	720290	12.8	861-R2228	277	1	1	No	721518	17.7
861-Q2386N	276	1	1	No	720306	19.95	861-R2228A	277	1	1	No	721525	-
861-Q2421	275	1	1	No	720313	29.159	861-R2228N	277	1	1	No	721532	-
861-Q2421A	275	1	1	No	720320	37	861-R2286	278	1	1	No	721549	10.743
861-Q2421N	275	1	1	No	720337	42.132	861-R2286A	278	1	1	No	721556	10.743
861-Q2426	273	1	1	No	720344	21.75	861-R2286N	278	1	1	No	721563	13.893
861-Q2426A	273	1	1	No	720351	26	861-R2328	277	1	1	No	721570	21.1
861-Q2426N	273	1	1	No	720368	33.8	861-R2328A	277	1	1	No	721587	-
861-Q2428	274	1	1	No	720375	23.02	861-R2328N	277	1	1	No	721594	-
861-Q2428A	274	1	1	No	720382	30.722	861-R2386	278	1	1	No	721600	10.743
861-Q2428N	274	1	1	No	720399	35.993	861-R2386A	278	1	1	No	721617	15.65
861-Q2486	276	1	1	No	720405	14.017	861-R2386N	278	1	1	No	721624	13.542
861-Q2486A	276	1	1	No	720412	14.017	861-R2428	277	1	1	No	721631	22.55
861-Q2486N	276	1	1	No	720429	20	861-R2428A	277	1	1	No	721648	27.461
861-QF2221	275	1	1	No	720795	36.321	861-R2428N	277	1	1	No	721655	-
861-QF2221A	275	1	1	No	720801	36.321	861-R2486	278	1	1	No	721662	10.743
861-QF2221N	275	1	1	No	720818	44.764	861-R2486A	278	1	1	No	721679	10.743
861-QF2226	273	1	1	No	720825	31.205	861-R2486N	278	1	1	No	721686	10.743
861-QF2226A	273	1	1	No	720832	31.205	861-RF2228	277	1	1	No	721877	24.452
861-QF2226N	273	1	1	No	720849	47.1	861-RF2228A	277	1	1	No	721884	24.452
861-QF2228	274	1	1	No	720856	31.205	861-RF2228N	277	1	1	No	721891	24.452
861-QF2228A	274	1	1	No	720863	31.205	861-RF2286	278	1	1	No	721907	13.812
861-QF2228N	274	1	1	No	720870	39.648	861-RF2286A	278	1	1	No	721914	16.718
861-QF2286	276	1	1	No	720887	20.769	861-RF2286N	278	1	1	No	721921	13.812
861-QF2286A	276	1	1	No	720894	20.769	861-RF2328	277	1	1	No	721938	24.452
861-QF2286N	276	1	1	No	720900	20.769	861-RF2328A	277	1	1	No	721945	24.452
861-QF2321	275	1	1	No	720917	36.321	861-RF2328N	277	1	1	No	721952	24.452
861-QF2321A	275	1	1	No	720924	36.321	861-RF2386	278	1	1	No	721969	15.9
861-QF2321N	275	1	1	No	720931	44.764	861-RF2386A	278	1	1	No	721976	19.7
861-QF2326	273	1	1	No	720948	31.205	861-RF2386N	278	1	1	No	721983	16.962
861-QF2326A	273	1	1	No	720955	31.9217	861-RF2428	277	1	1	No	721990	24.452
861-QF2326N	273	1	1	No	720962	39.648	861-RF2428A	277	1	1	No	722003	42.5
861-QF2328	274	1	1	No	720979	31.205	861-RF2428N	277	1	1	No	722010	24.452
861-QF2328A	274	1	1	No	720986	31.205	861-RF2486	278	1	1	No	722027	13.812
861-QF2328N	274	1	1	No	720993	39.648	861-RF2486A	278	1	1	No	722034	13.812
861-QF2386	276	1	1	No	721006	20.769	861-RF2486N	278	1	1	No	722041	16.962

Supply

Drainage

Support

Specialties

Appendix

# Numerical Index

Supply

Drainage

Support

Specialties

Appendix

Item No	Page No	Min Qty	Case Qty	UPC Bar-Coded	UPC 6-Digit	Weight (lbs.)	Item No	Page No	Min Qty	Case Qty	UPC Bar-Coded	UPC 6-Digit	Weight (lbs.)
861-SQ2428	279	1	1	Yes	741158	30.86	862-235SQ	256	1	1	No	717528	6.61
861-TA22	150	1	1	No	722232	2.27	862-235SR	256	1	1	No	717221	9.097
861-TA22	273	1	1	No	722232	2.27	862-236NQ	255	1	1	No	716958	10.025
861-TA22	274	1	1	No	722232	2.27	862-236NR	255	1	1	No	716651	8.55
861-TA22	275	1	1	No	722232	2.27	862-236SQ	256	1	1	No	717559	-
861-TA22	276	1	1	No	722232	2.27	862-236SR	256	1	1	No	717252	7.175
861-TA22	277	1	1	No	722232	2.27	862-237I	257	1	1	No	718068	13.46
861-TA22	278	1	1	No	722232	2.27	862-237IN	257	1	1	No	717948	-
861-TA23	150	1	1	No	722249	3.32	862-237NQ	255	1	1	No	716989	6.61
861-TA23	273	1	1	No	722249	3.32	862-237NR	255	1	1	No	716682	6.61
861-TA23	274	1	1	No	722249	3.32	862-237NRE	256	1	1	No	724335	6.61
861-TA23	275	1	1	No	722249	3.32	862-238NQ	255	1	1	No	717016	11.57
861-TA23	276	1	1	No	722249	3.32	862-238NR	255	1	1	No	716712	6.61
861-TA23	277	1	1	No	722249	3.32	862-239I	257	1	1	No	718099	20.258
861-TA23	278	1	1	No	722249	3.32	862-239IN	257	1	1	No	717979	21.056
861-TA24	150	1	1	No	722256	5.379	862-239INQ	257	1	1	No	741073	23.5
861-TA24	273	1	1	No	722256	5.379	862-239IQ	257	1	1	No	741011	20
861-TA24	274	1	1	No	722256	5.379	862-2410NQ	255	1	1	No	717054	6.73
861-TA24	275	1	1	No	722256	5.379	862-2410NR	255	1	1	No	716750	12.46
861-TA24	276	1	1	No	722256	5.379	862-2410NRE	256	1	1	No	723956	-
861-TA24	277	1	1	No	722256	5.379	862-245NQ	255	1	1	No	716934	9.3
861-TA24	278	1	1	No	722256	5.379	862-245NR	255	1	1	No	716637	9
861-UM	356	1	5	Yes	302892	0.083	862-245SQ	256	1	1	No	717535	6.73
862-2210NQ	255	1	1	No	717030	6.34	862-245SR	256	1	1	No	717238	8.652
862-2210NR	255	1	1	No	716736	-	862-246NQ	255	1	1	No	716965	9.58
862-2210NRE	256	1	1	No	723864	-	862-246NR	255	1	1	No	716668	9.15
862-225NQ	255	1	1	No	716910	6.34	862-246SQ	256	1	1	No	717566	-
862-225NR	255	1	1	No	716613	8	862-246SR	256	1	1	No	717269	-
862-225SQ	256	1	1	No	717511	6.34	862-247I	257	1	1	No	718075	14.145
862-225SR	256	1	1	No	717214	8.262	862-247IN	257	1	1	No	717955	14.93
862-226NQ	255	1	1	No	716941	9.755	862-247NQ	255	1	1	No	716996	6.73
862-226NR	255	1	1	No	716644	6.34	862-247NR	255	1	1	No	716699	7.295
862-226SQ	256	1	1	No	717542	10.236	862-247NRE	256	1	1	No	724342	-
862-226SR	256	1	1	No	717245	6.905	862-248NQ	255	1	1	No	717023	11.69
862-227I	257	1	1	No	718051	13.19	862-248NR	255	1	1	No	716729	6.73
862-227IN	257	1	1	No	717931	-	862-249I	257	1	1	No	718105	20.943
862-227NQ	255	1	1	No	716972	6.34	862-249IN	257	1	1	No	717986	21.176
862-227NR	255	1	1	No	716675	6.905	862-249INQ	257	1	1	No	741080	23.5
862-227NRE	256	1	1	No	717849	6.905	862-249IQ	257	1	1	No	741028	20
862-228NQ	255	1	1	No	717009	11.3	862-410LNQ	266	1	4	Yes	716491	-
862-228NR	255	1	1	No	716705	6.34	862-410LNR	266	1	8	Yes	716446	5.73
862-229I	257	1	1	No	718082	19.988	862-410LNRE	266	1	8	Yes	716552	5.732
862-229IN	257	1	1	No	717962	-	862-45LNQ	266	1	20	Yes	716453	2.15
862-229INQ	257	1	1	No	741066	23.5	862-45LNR	266	1	20	Yes	716408	1.645
862-229IQ	257	1	1	No	741004	20	862-45LSQ	267	1	20	Yes	716538	2.396
862-2310NQ	255	1	1	No	717047	6.61	862-45LSR	267	1	24	Yes	716507	1.922
862-2310NR	255	1	1	No	716743	12.34	862-46LNQ	266	1	16	Yes	716460	2.85
862-2310NRE	256	1	1	No	723949	-	862-46LNR	266	1	20	Yes	716415	1.94
862-235NQ	255	1	1	No	716927	8.7	862-46LSQ	267	1	16	Yes	716521	3.331
862-235NR	255	1	1	No	716620	3.5555	862-46LSR	267	1	20	Yes	716514	2.5



Item No	Page No	Min Qty	Case Qty	UPC Bar-Coded	UPC 6-Digit	Weight (lbs.)	Item No	Page No	Min Qty	Case Qty	UPC Bar-Coded	UPC 6-Digit	Weight (lbs.)
862-47LI	267	1	1	Yes	716569	6.85	862-638NR	258	1	1	No	716866	7.46
862-47LIN	267	1	4	Yes	716583	8.2	862-639I	260	1	1	No	718150	21.108
862-47LNQ	266	1	12	Yes	716477	3.6167	862-639IN	260	1	1	No	718037	-
862-47LNR	266	1	12	Yes	716422	3.03	862-639INQ	260	1	1	No	741103	23.5
862-47LNRE	266	1	8	Yes	716545	4.23	862-639IQ	260	1	1	No	741042	20
862-48LNQ	266	1	8	Yes	716484	4.96	862-6410NQ	258	1	1	No	717207	8.665
862-48LNR	266	1	8	Yes	716439	-	862-6410NR	258	1	1	No	716903	8.1
862-49LI	267	1	1	Yes	716576	13.648	862-6410NRE	259	1	1	No	723963	-
862-49LIN	267	1	1	Yes	716590	13.75	862-645NQ	258	1	1	No	717085	8.665
862-49LINQ	267	1	1	Yes	735942	17	862-645NR	257	1	1	No	716781	9.745
862-49LIQ	267	1	1	Yes	735935	13.33	862-645SQ	259	1	1	No	717689	8.1
862-6210NQ	258	1	1	No	717184	7.1	862-645SR	259	1	1	No	717382	10.022
862-6210NR	258	1	1	No	716880	7.1	862-646NQ	258	1	1	No	717115	11.515
862-6210NRE	259	1	1	No	723925	-	862-646NR	258	1	1	No	716811	8.665
862-625NQ	258	1	1	No	717061	7.1	862-646SQ	259	1	1	No	717719	11.431
862-625NR	257	1	1	No	716767	9.31	862-646SR	259	1	1	No	717412	7.46
862-625SQ	259	1	1	No	717665	7.1	862-647I	260	1	1	No	718136	-
862-625SR	259	1	1	No	717368	9.022	862-647IN	260	1	1	No	718013	16.865
862-626NQ	258	1	1	No	717092	10.5	862-647NQ	258	1	1	No	717146	8.665
862-626NR	258	1	1	No	716798	7.1	862-647NR	258	1	1	No	716842	8.665
862-626SQ	259	1	1	No	717696	10.791	862-647NRE	259	1	1	No	724359	-
862-626SR	259	1	1	No	717399	7.1	862-648NQ	258	1	1	No	717177	13.625
862-627I	260	1	1	No	718112	-	862-648NR	258	1	1	No	716873	8.1
862-627IN	260	1	1	No	717993	-	862-649I	260	1	1	No	718167	20.0096
862-627NQ	258	1	1	No	717122	7.1	862-649IN	260	1	1	No	718044	-
862-627NR	258	1	1	No	716828	7.1	862-649INQ	260	1	1	No	741110	23.5
862-627NRE	259	1	1	No	717900	7.665	862-649IQ	260	1	1	No	741059	20
862-628NQ	258	1	1	No	717153	-	862-B22	268	1	1	No	725950	6.34
862-628NR	258	1	1	No	716859	7.1	862-B23	268	1	1	No	725967	6.61
862-629I	260	1	1	No	718143	-	862-B24	268	1	1	No	725974	6.73
862-629IN	260	1	1	No	718020	-	862-B62	268	1	1	No	725981	7.1
862-629INQ	260	1	1	No	741097	23.5	862-B63	268	1	1	No	726193	7.46
862-629IQ	260	1	1	No	741035	20	862-B64	268	1	1	No	725998	8.1
862-6310NQ	258	1	1	No	717191	8.025	862-EX4	255	1	16	No	716606	-
862-6310NR	258	1	1	No	716897	7.46	862-EX4	256	1	16	No	716606	-
862-6310NRE	259	1	1	No	726483	-	862-EX4	256	1	16	No	716606	-
862-635NQ	258	1	1	No	717078	8.025	862-EX4	257	1	16	No	716606	-
862-635NR	257	1	1	No	716774	9.105	862-EX4	258	1	16	No	716606	-
862-635SQ	259	1	1	No	717672	7.46	862-EX4	259	1	16	No	716606	-
862-635SR	259	1	1	No	717375	9.382	862-EX4	259	1	16	No	716606	-
862-636NQ	258	1	1	No	717108	10.85	862-EX4	260	1	16	No	716606	-
862-636NR	258	1	1	No	716804	7.46	862-EX4	266	1	16	No	716606	-
862-636SQ	259	1	1	No	717702	10.791	862-EX4	266	1	16	No	716606	-
862-636SR	259	1	1	No	717405	7.46	862-EX4	267	1	16	No	716606	-
862-637I	260	1	1	No	718129	-	862-EX4	267	1	16	No	716606	-
862-637IN	260	1	1	No	718006	-	862-EX4	269	1	16	No	716606	-
862-637NQ	258	1	1	No	717139	8.025	863-22NQ	345	1	2	Yes	354983	11.2458
862-637NR	258	1	1	No	716835	7.46	863-22NR	345	1	3	Yes	302908	8.72
862-637NRE	259	1	1	No	717917	8.025	863-22SQ	345	1	1	Yes	308320	10.4069
862-638NQ	258	1	1	No	717160	12.985	863-22SR	345	1	1	Yes	308337	10.0658

Supply

Drainage

Support

Specialties

Appendix

# Numerical Index

Supply

Drainage

Support

Specialties

Appendix

Item No	Page No	Min Qty	Case Qty	UPC Bar-Coded	UPC 6-Digit	Weight (lbs.)	Item No	Page No	Min Qty	Case Qty	UPC Bar-Coded	UPC 6-Digit	Weight (lbs.)
863-23NQ	345	1	2	Yes	355027	9.41	863-435SQ	344	1	2	Yes	308634	3.8717
863-23NR	345	1	2	Yes	350640	8.1034	863-435SQ	422	1	2	Yes	308634	3.8717
863-23SQ	345	1	1	Yes	308344	8.6755	863-435SR	344	1	6	Yes	308481	3.1083
863-23SR	345	1	1	Yes	308351	8.4169	863-435SR	422	1	6	Yes	308481	3.1083
863-24NQ	345	1	1	Yes	355065	10.8914	863-43NQ	343	1	2	Yes	304810	4.36
863-24NR	345	1	1	Yes	355072	9.8914	863-43NR	343	1	6	Yes	304803	4.2207
863-24SQ	345	1	1	Yes	308368	10.1755	863-43SQ	343	1	1	Yes	308641	4.55
863-24SR	345	1	2	Yes	308375	9.9365	863-43SR	343	1	1	Yes	308498	3.3
863-325NQ	344	1	2	Yes	355119	4.3377	863-445NQ	344	1	1	Yes	355577	4.7733
863-325NR	344	1	6	Yes	302915	2.7833	863-445NR	344	1	6	Yes	303042	3.9727
863-325SQ	344	1	2	Yes	308665	3.5217	863-44NQ	343	1	2	Yes	355614	5.3213
863-325SR	344	1	6	Yes	308535	2.7817	863-44NR	343	1	6	Yes	304780	3.275
863-32NQ	343	1	2	Yes	355164	4.9857	863-44SQ	343	1	1	Yes	308658	4.5961
863-32NR	343	1	6	Yes	355171	3.9668	863-44SR	343	1	1	Yes	308528	3.3417
863-32SQ	343	1	2	Yes	308672	4.2561	863-62NQ	346	1	1	Yes	355669	9.7844
863-32SR	343	1	6	Yes	308542	3.8796	863-62NR	346	1	3	Yes	355676	8.7844
863-335CQ	422	1	2	Yes	312235	3.6867	863-62SQ	346	1	1	Yes	308382	8.9455
863-335CR	422	1	1	Yes	312228	2.8167	863-62SR	346	1	1	Yes	308399	8.7065
863-335NQ	344	1	2	Yes	355225	4.5983	863-63NQ	346	1	1	Yes	355713	11.2314
863-335NQ	422	1	2	Yes	355225	4.5983	863-63NR	346	1	2	Yes	351210	10.2314
863-335NR	344	1	6	Yes	350657	3.7977	863-63SQ	346	1	1	Yes	308429	10.5155
863-335NR	422	1	6	Yes	350657	3.7977	863-63SR	346	1	1	Yes	308436	10.2765
863-335SQ	344	1	2	Yes	308689	3.6867	863-64NQ	346	1	1	Yes	355751	11.4444
863-335SQ	422	1	2	Yes	308689	3.6867	863-64NR	346	1	2	Yes	355768	10.3351
863-335SR	344	1	6	Yes	308559	2.8167	863-64SQ	346	1	1	Yes	308443	10.7285
863-335SR	422	1	6	Yes	308559	2.8167	863-64SR	346	1	1	Yes	308450	10.4895
863-33NQ	343	1	1	Yes	355270	5.1463	863-FA	328	1	12	Yes	355775	0.7292
863-33NR	343	1	6	Yes	355287	4.0507	863-FA	329	1	12	Yes	355775	0.7292
863-33SQ	343	1	2	Yes	308696	4.4211	863-FA	331	1	12	Yes	355775	0.7292
863-33SR	343	1	6	Yes	308566	4.0446	863-FA	332	1	12	Yes	355775	0.7292
863-345NQ	344	1	2	Yes	355331	4.6483	863-FA	336	1	12	Yes	355775	0.7292
863-345NR	344	1	6	Yes	355348	3.7583	863-FA	337	1	12	Yes	355775	0.7292
863-34NQ	343	1	2	Yes	355393	5.1963	863-FA	338	1	12	Yes	355775	0.7292
863-34NR	343	1	6	Yes	355409	4.1007	863-FA	339	1	12	Yes	355775	0.7292
863-34SQ	343	1	2	Yes	308702	4.4711	863-FA	341	1	12	Yes	355775	0.7292
863-34SR	343	1	6	Yes	308573	4.0946	863-FA	342	1	12	Yes	355775	0.7292
863-425NQ	344	1	2	Yes	350688	3.6	863-FA	343	1	12	Yes	355775	0.7292
863-425NR	344	1	6	Yes	302939	3.0417	863-FA	344	1	12	Yes	355775	0.7292
863-425SQ	344	1	2	Yes	308580	3.8067	863-FA	345	1	12	Yes	355775	0.7292
863-425SR	344	1	1	Yes	308467	3.0692	863-FA	346	1	12	Yes	355775	0.7292
863-42NQ	343	1	2	Yes	351159	5.4333	863-FA	347	1	12	Yes	355775	0.7292
863-42NR	343	1	6	Yes	302953	3.117	863-FA	349	1	12	Yes	355775	0.7292
863-42SQ	343	1	1	Yes	308597	4.5456	863-FA	351	1	12	Yes	355775	0.7292
863-42SR	343	1	6	Yes	308474	3.2167	863-FA	356	1	12	Yes	355775	0.7292
863-435CQ	422	1	2	Yes	312211	3.8717	863-FA	358	1	12	Yes	355775	0.7292
863-435CR	422	1	6	Yes	312204	3.1083	863-FA	359	1	12	Yes	355775	0.7292
863-435NQ	344	1	2	Yes	351166	4.7833	863-FACQ	245	1	12	Yes	355775	0.0608
863-435NQ	422	1	2	Yes	351166	4.7833	863-FACQ	246	1	12	Yes	355775	0.0608
863-435NR	344	1	6	Yes	302984	3.0517	863-FACQ	247	1	12	Yes	355775	0.0608
863-435NR	422	1	6	Yes	302984	3.0517	863-FACQ	248	1	12	Yes	355775	0.0608

Item No	Page No	Min Qty	Case Qty	UPC Bar-Coded	UPC 6-Digit	Weight (lbs.)	Item No	Page No	Min Qty	Case Qty	UPC Bar-Coded	UPC 6-Digit	Weight (lbs.)
863-FACQ	249	1	12	Yes	355775	0.0608	863-FNCQ	273	1	12	Yes	351128	0.1649
863-FACQ	251	1	12	Yes	355775	0.0608	863-FNCQ	274	1	12	Yes	351128	0.1649
863-FACQ	252	1	12	Yes	355775	0.0608	863-FNCQ	275	1	12	Yes	351128	0.1649
863-FACQ	253	1	12	Yes	355775	0.0608	863-FNCQ	276	1	12	Yes	351128	0.1649
863-FACQ	254	1	12	Yes	355775	0.0608	863-FNCQ	277	1	12	Yes	351128	0.1649
863-FACQ	255	1	12	Yes	355775	0.0608	863-FNCQ	278	1	12	Yes	351128	0.1649
863-FACQ	258	1	12	Yes	355775	0.0608	863-FNO	328	1	12	Yes	351340	3.4
863-FACQ	261	1	12	Yes	355775	0.0608	863-FNO	329	1	12	Yes	351340	3.4
863-FACQ	262	1	12	Yes	355775	0.0608	863-FNO	331	1	12	Yes	351340	3.4
863-FACQ	269	1	12	Yes	355775	0.0608	863-FNO	332	1	12	Yes	351340	3.4
863-FACQ	273	1	12	Yes	355775	0.0608	863-FNO	336	1	12	Yes	351340	3.4
863-FACQ	274	1	12	Yes	355775	0.0608	863-FNO	337	1	12	Yes	351340	3.4
863-FACQ	275	1	12	Yes	355775	0.0608	863-FNO	338	1	12	Yes	351340	3.4
863-FACQ	276	1	12	Yes	355775	0.0608	863-FNO	339	1	12	Yes	351340	3.4
863-FACQ	277	1	12	Yes	355775	0.0608	863-FNO	341	1	12	Yes	351340	3.4
863-FACQ	278	1	12	Yes	355775	0.0608	863-FNO	342	1	12	Yes	351340	3.4
863-FN	328	1	12	Yes	351128	1.9792	863-FNO	343	1	12	Yes	351340	3.4
863-FN	329	1	12	Yes	351128	1.9792	863-FNO	345	1	12	Yes	351340	3.4
863-FN	331	1	12	Yes	351128	1.9792	863-FNO	346	1	12	Yes	351340	3.4
863-FN	332	1	12	Yes	351128	1.9792	863-FNO	347	1	12	Yes	351340	3.4
863-FN	336	1	12	Yes	351128	1.9792	863-FNO	349	1	12	Yes	351340	3.4
863-FN	337	1	12	Yes	351128	1.9792	863-FNO	351	1	12	Yes	351340	3.4
863-FN	338	1	12	Yes	351128	1.9792	863-FNO	356	1	12	Yes	351340	3.4
863-FN	339	1	12	Yes	351128	1.9792	863-FNO	358	1	12	Yes	351340	3.4
863-FN	341	1	12	Yes	351128	1.9792	863-FNO	359	1	12	Yes	351340	3.4
863-FN	342	1	12	Yes	351128	1.9792	863-FNOCQ	245	1	12	Yes	351340	0.2833
863-FN	343	1	12	Yes	351128	1.9792	863-FNOCQ	246	1	12	Yes	351340	0.2833
863-FN	344	1	12	Yes	351128	1.9792	863-FNOCQ	247	1	12	Yes	351340	0.2833
863-FN	345	1	12	Yes	351128	1.9792	863-FNOCQ	248	1	12	Yes	351340	0.2833
863-FN	346	1	12	Yes	351128	1.9792	863-FNOCQ	249	1	12	Yes	351340	0.2833
863-FN	347	1	12	Yes	351128	1.9792	863-FNOCQ	251	1	12	Yes	351340	0.2833
863-FN	349	1	12	Yes	351128	1.9792	863-FNOCQ	252	1	12	Yes	351340	0.2833
863-FN	351	1	12	Yes	351128	1.9792	863-FNOCQ	253	1	12	Yes	351340	0.2833
863-FN	356	1	12	Yes	351128	1.9792	863-FNOCQ	254	1	12	Yes	351340	0.2833
863-FN	358	1	12	Yes	351128	1.9792	863-FNOCQ	255	1	12	Yes	351340	0.2833
863-FN	359	1	12	Yes	351128	1.9792	863-FNOCQ	258	1	12	Yes	351340	0.2833
863-FNCQ	245	1	12	Yes	351128	0.1649	863-FNOCQ	269	1	12	Yes	351340	0.2833
863-FNCQ	246	1	12	Yes	351128	0.1649	863-FNOCQ	273	1	12	Yes	351340	0.2833
863-FNCQ	247	1	12	Yes	351128	0.1649	863-FNOCQ	274	1	12	Yes	351340	0.2833
863-FNCQ	248	1	12	Yes	351128	0.1649	863-FNOCQ	275	1	12	Yes	351340	0.2833
863-FNCQ	249	1	12	Yes	351128	0.1649	863-FNOCQ	276	1	12	Yes	351340	0.2833
863-FNCQ	251	1	12	Yes	351128	0.1649	863-FNOCQ	277	1	12	Yes	351340	0.2833
863-FNCQ	252	1	12	Yes	351128	0.1649	863-FNOCQ	278	1	12	Yes	351340	0.2833
863-FNCQ	253	1	12	Yes	351128	0.1649	863-HA23	351	1	10	Yes	304476	1.8834
863-FNCQ	254	1	12	Yes	351128	0.1649	863-HA33	351	1	10	Yes	355782	2.0484
863-FNCQ	255	1	12	Yes	351128	0.1649	863-HA44	351	1	10	Yes	355812	2.0534
863-FNCQ	258	1	12	Yes	351128	0.1649	863-HP23	351	1	10	Yes	303295	2.1172
863-FNCQ	261	1	12	Yes	351128	0.1649	863-HP33	351	1	10	Yes	303134	2.2334
863-FNCQ	262	1	12	Yes	351128	0.1649	863-HP34	351	1	10	Yes	351531	2.1734
863-FNCQ	269	1	12	Yes	351128	0.1649	863-HP44	351	1	10	Yes	303158	2.1784

Supply

Drainage

Support

Specialties

Appendix

# Numerical Index

Supply

Drainage

Support

Specialties

Appendix

Item No	Page No	Min Qty	Case Qty	UPC Bar-Coded	UPC 6-Digit	Weight (lbs.)	Item No	Page No	Min Qty	Case Qty	UPC Bar-Coded	UPC 6-Digit	Weight (lbs.)
863-U	356	1	5	Yes	305572	0.38	865-8PC	398	1	1	No	729682	-
863-U	358	1	5	Yes	305572	0.38	865-8PC	398	1	1	No	729682	-
864-2A	334	1	3	Yes	351241	2.3617	865-8RS	398	1	1	No	729699	-
864-2P	334	1	3	Yes	351142	3.075	865-8RS	398	1	1	No	729699	-
864-3A	334	1	3	Yes	355874	2.525	865-A	388	1	20	No	324801	0.155
864-3P	334	1	3	Yes	303172	2.6617	865-A	389	1	20	No	324801	0.155
864-4A	334	1	3	Yes	355881	4.3294	865-C	388	1	1	No	324818	2.0369
864-4P	334	1	3	Yes	303219	2.73	865-C	389	1	1	No	324818	2.0369
864-GP	334	1	1	Yes	355898	1.1584	865-CB4	388	1	1	Yes	735027	0.6
864-GP2	334	1	1	Yes	737182	0.894	865-CB6	388	1	1	Yes	735041	0.55
864-S	334	1	10	Yes	303196	0.3245	865-D	388	1	1	Yes	327475	0.55
864-UM	334	1	10	Yes	306456	0.6992	865-EC	388	1	50	Yes	323989	0.46
864-UM	359	1	10	Yes	306456	0.6992	865-EG	388	1	1	Yes	325174	1.45
864-W2P	359	1	3	Yes	315724	2.95	865-EG	389	1	1	Yes	325174	1.45
864-W3P	359	1	3	Yes	315731	3	865-EO	388	1	25	Yes	323996	0.7125
864-W4P	359	1	3	Yes	315748	3.0833	865-F	388	1	1	Yes	324030	15.325
864-WGP	359	1	1	Yes	315755	1.2	865-F	389	1	1	Yes	324030	15.325
864-WGP2	359	1	1	Yes	321879	1.3868	865-FB	388	1	1	Yes	734990	9
864-WS	359	1	10	Yes	315762	0.4107	865-FC	388	1	1	Yes	734983	27.4
865-12ECD	398	1	1	No	729514	16.6	865-FCB	388	1	1	Yes	734686	40.12
865-12OCD	398	1	1	No	729521	12.95	865-GGD	387	1	1	Yes	329363	6.825
865-12PC	406	1	1	No	724779	2.6	865-GGD	389	1	1	Yes	329363	6.825
865-16ECD	398	1	1	No	729538	23.35	865-GGS	387	1	1	Yes	324047	6.1
865-16OCD	398	1	1	No	729545	18.4	865-GGS	389	1	1	Yes	324047	6.1
865-4BK	394	1	1	No	734631	3	865-GGSR	387	1	1	Yes	327932	15.9
865-4BK	401	1	1	No	734631	3	865-GGSR	389	1	1	Yes	327932	15.9
865-4EC	394	1	1	No	729552	-	865-GHC	387	1	1	Yes	712288	5.3
865-4EC	401	1	1	No	729552	-	865-GHC	389	1	1	Yes	712288	5.3
865-4LPEC3	394	1	1	No	729569	-	865-GHS	387	1	2	Yes	324061	3.847
865-4LPEC3	401	1	1	No	729569	-	865-GHS	389	1	2	Yes	324061	3.847
865-4LPEC4	394	1	1	No	729576	-	865-GIC	387	1	1	Yes	324078	18.75
865-4LPEC4	401	1	1	No	729576	-	865-GIC	388	1	1	Yes	324078	18.75
865-4LR	394	1	1	No	729583	-	865-GID	387	1	1	Yes	324085	19.35
865-4LR	401	1	1	No	729583	-	865-GID	388	1	1	Yes	324085	19.35
865-4OC	394	1	1	No	729590	0.1125	865-GIS	387	1	1	Yes	324092	19.25
865-4OC	401	1	1	No	729590	0.1125	865-GIS	388	1	1	Yes	324092	19.25
865-4PC	394	1	1	No	729606	0.0148	865-GSA	387	1	1	Yes	715463	6.65
865-4PC	401	1	1	No	729606	0.0148	865-GSA	389	1	1	Yes	715463	6.65
865-4RS	394	1	1	No	729613	0.0029	865-GSB	387	1	2	Yes	725035	13.5
865-4RS	401	1	1	No	729613	0.0029	865-GSB	389	1	2	Yes	725035	13.5
865-6LR	396	1	1	No	729620	0.037	865-GSBC	387	1	1	No	739032	10.3
865-6PC	396	1	1	No	729637	0.95	865-GSBC	389	1	1	No	739032	10.3
865-6PC	397	1	1	No	729637	0.95	865-GSD	387	1	1	Yes	324108	5.3
865-6PCE	396	1	1	No	729644	-	865-GSD	389	1	1	Yes	324108	5.3
865-6RS	396	1	1	No	729651	-	865-GSS	387	1	1	Yes	324115	6.05
865-6RS	397	1	1	No	729651	-	865-GSS	389	1	1	Yes	324115	6.05
865-6UC	396	1	20	Yes	729668	0.4	865-GSSR	387	1	1	Yes	327949	16.075
865-8ECD	397	1	1	No	738110	7.28	865-GSSR	389	1	1	Yes	327949	16.075
865-8LR	397	1	1	No	729675	-	865-HB12005BFA	406	1	1	No	729712	231.4851
865-8OCD	397	1	1	No	738127	5	865-HB1200FA	406	1	1	No	722638	242.5082

Item No	Page No	Min Qty	Case Qty	UPC Bar-Coded	UPC 6-Digit	Weight (lbs.)	Item No	Page No	Min Qty	Case Qty	UPC Bar-Coded	UPC 6-Digit	Weight (lbs.)
865-HB12ADA005BFA	406	1	1	No	729729	231.4851	865-HLDC	409	1	1	No	725943	-
865-HB12ADA005FA	406	1	1	No	722799	68.85	865-HLEC	409	1	1	No	730084	0.1
865-HB12ADA005SFA	406	1	1	No	723413	-	865-HLISC	409	1	1	No	730091	0.15
865-HB12ADA00FA	406	1	1	No	722621	242.5082	865-HLP4AB	409	1	1	No	730107	3.3069
865-HB12EC	406	1	1	No	729736	4.1	865-HLP4C	409	1	1	No	730114	7.9366
865-HB12OC	406	1	1	No	729743	-	865-HLP4N00F1M	409	1	1	No	730121	9.9208
865-HB12S	406	1	1	No	729750	-	865-HLP4N00F3M	409	1	1	No	730138	26.4554
865-HB4005BFA	405	1	1	No	729767	37.4785	865-HLP4T	409	1	1	No	730145	13.0073
865-HB4005SFA	405	1	1	No	729781	37.4785	865-HLP4X	409	1	1	No	730152	16.7551
865-HB400FA	405	1	1	No	729798	67.2409	865-HLPCE	409	1	1	No	730169	0.25
865-HB4CBFA	405	1	1	No	729804	83.7756	865-HLPEC	409	1	1	No	730176	0.15
865-HB4EC	405	1	1	No	729811	-	865-HLPED	409	1	1	No	730183	0.575
865-HB4INSB	405	1	1	No	729828	-	865-HLPISC	409	1	1	No	730190	0.15
865-HB4OC	405	1	1	No	729835	-	865-HLPPED	409	1	1	No	724526	1.4286
865-HB6005BFA	405	1	1	No	729842	68.3432	865-M12PCBEA	397	1	1	No	730206	313.056
865-HB6005HSFA	405	1	1	No	729859	70.5478	865-M12PCBFA	398	1	1	No	730213	328.4884
865-HB600FA	405	1	1	No	729866	110.8924	865-M12PN005EA	397	1	1	No	730220	217.1551
865-HB6ADA005BFA	405	1	1	No	729873	68.3432	865-M12PN005FA	398	1	1	No	730237	227.0759
865-HB6ADA005FA	405	1	1	No	729880	68.3432	865-M12PN00BEA	397	1	1	No	730244	423.287
865-HB6ADA005HSFA	405	1	1	No	729897	70.5478	865-M12PN00BFA	398	1	1	No	730251	438.7194
865-HB6ADA00FA	405	1	1	No	729903	110.8924	865-M12PN00EA	397	1	1	No	730268	432.7669
865-HB6ADACBFA	405	1	1	No	729910	121.2541	865-M12PN00FA	398	1	1	No	730275	453.0494
865-HB6AINSB	405	1	1	No	735850	6.4	865-M16PCBEA	398	1	1	No	730282	374.7854
865-HB6AINSB	406	1	1	No	735850	6.4	865-M16PCBFA	398	1	1	No	730299	396.8316
865-HB6AINSB	406	1	1	No	735850	6.4	865-M16PN005EA	398	1	1	No	730305	286.6006
865-HB6CBFA	405	1	1	No	729927	121.2541	865-M16PN005FA	398	1	1	No	730312	297.6237
865-HB6DS	405	1	1	No	744074	0.45	865-M16PN00BEA	398	1	1	No	730329	546.7458
865-HB6EC	405	1	1	No	729934	0.6	865-M16PN00BFA	398	1	1	No	730336	568.792
865-HB6INSB	405	1	1	No	729941	-	865-M16PN00EA	398	1	1	No	730343	551.155
865-HB6INSB	406	1	1	No	729941	-	865-M16PN00FA	398	1	1	No	730350	593.0428
865-HB6INSB	406	1	1	No	729941	-	865-M4CB	394	1	1	No	730367	94.7987
865-HB6OC	405	1	1	No	729958	0.55	865-M4DICH	393	1	1	No	730374	11.2436
865-HB8005BFA	405	1	1	No	729965	97.0033	865-M4DICT	393	1	1	No	730381	8.5
865-HB8005SFA	405	1	1	No	729972	99.2079	865-M4DIDL	393	1	1	No	730398	11.464
865-HB800FA	405	1	1	No	729989	145.7254	865-M4DIEM	393	1	1	No	741684	12.12
865-HB8ADA005BFA	406	1	1	No	724786	97.0033	865-M4DIFH	393	1	1	No	730404	15.6528
865-HB8ADA005FA	406	1	1	No	741325	100	865-M4DIFL	393	1	1	No	730411	15.6528
865-HB8ADA005SFA	406	1	1	No	729996	99.2079	865-M4LP00	394	1	1	No	730428	33.0693
865-HB8ADA00FA	406	1	1	No	724199	145.7254	865-M4LP005	394	1	1	No	730435	16.5346
865-HB8ADACBFA	406	1	1	No	724793	136.6864	865-M4LP00B	394	1	1	No	730442	33.0693
865-HB8CBFA	405	1	1	No	730008	136.6864	865-M4N00	394	1	1	No	730459	61.7294
865-HB8EC	406	1	1	No	730015	1.05	865-M4N005	394	1	1	No	730466	31.967
865-HB8OC	406	1	1	No	730022	-	865-M4N00B	394	1	1	No	730473	61.7294
865-HL4L	409	1	1	No	727947	48.4	865-M4N10	393	1	1	No	730480	66.1386
865-HL4N005BF	409	1	1	No	730039	15.4323	865-M4N105	393	1	1	No	730497	33.0693
865-HL4N005K	409	1	1	No	730046	15.4323	865-M4N105S	393	1	1	No	730503	30.8647
865-HL4N00CSF	409	1	1	No	730053	26.4554	865-M4N10B	393	1	1	No	730510	66.1386
865-HL4N00F	409	1	1	No	730060	23.75	865-M4N15	393	1	1	No	730527	78.264
865-HLAC	409	1	1	No	725936	4.25	865-M4N155	393	1	1	No	730534	39.6832
865-HLCE	409	1	1	No	730077	-	865-M4N155S	393	1	1	No	730541	37.4785

Supply

Drainage

Support

Specialties

Appendix

# Numerical Index

Supply

Drainage

Support

Specialties

Appendix

Item No	Page No	Min Qty	Case Qty	UPC Bar-Coded	UPC 6-Digit	Weight (lbs.)	Item No	Page No	Min Qty	Case Qty	UPC Bar-Coded	UPC 6-Digit	Weight (lbs.)
865-M4N15B	393	1	1	No	730558	78.264	865-M6N005SF1A	396	1	1	No	731050	98.1056
865-M4N20	393	1	1	No	730565	91.4917	865-M6N005SFA	395	1	1	No	731067	88.1848
865-M4N205	393	1	1	No	730572	41.8878	865-M6N00BDA	395	1	1	No	731074	150.3551
865-M4N205S	393	1	1	No	730589	39.6832	865-M6N00BF1A	396	1	1	No	731081	195.1089
865-M4N20B	393	1	1	No	730596	91.4917	865-M6N00BFA	395	1	1	No	731098	174.165
865-M4N25	393	1	1	No	730602	109.1066	865-M6N00DA	395	1	1	No	731104	150.3551
865-M4N255	393	1	1	No	730619	51.7865	865-M6N00F1A	396	1	1	No	731111	195.1089
865-M4N255S	393	1	1	No	730626	48.5016	865-M6N00FA	395	1	1	No	731128	174.165
865-M4N25B	393	1	1	No	730633	104.6974	865-M6N0055DA	395	1	1	No	731135	83.7756
865-M4N30	393	1	1	No	730640	114.6402	865-M6N0055FA	395	1	1	No	731142	97.0033
865-M4N305	393	1	1	No	730657	56.2178	865-M6N0055SDA	395	1	1	No	731159	81.5709
865-M4N305S	393	1	1	No	730664	56.2178	865-M6N0055SFA	396	1	1	No	731166	94.7987
865-M4N30B	393	1	1	No	730671	112.3915	865-M6N005BDA	395	1	1	No	731173	166.6693
865-M4S01	393	1	1	No	730688	67.4614	865-M6N005BFA	396	1	1	No	731180	193.1247
865-M4S02	393	1	1	No	730695	68.7841	865-M6N005DA	395	1	1	No	731197	166.6693
865-M4S03	393	1	1	No	730701	70.1069	865-M6N005FA	396	1	1	No	731203	193.1247
865-M4S04	393	1	1	No	730718	71.6502	865-M6N105DA	395	1	1	No	731210	90.3894
865-M4S05	393	1	1	No	730725	72.7525	865-M6N105FA	396	1	1	No	731227	102.5148
865-M4S06	393	1	1	No	730732	74.0752	865-M6N105SDA	395	1	1	No	731234	88.1848
865-M4S07	393	1	1	No	730749	75.6185	865-M6N105SFA	396	1	1	No	731241	97.0033
865-M4S08	393	1	1	No	730756	77.3822	865-M6N10BDA	395	1	1	No	731258	178.5742
865-M4S09	393	1	1	No	730763	78.9254	865-M6N10BFA	396	1	1	No	731265	202.825
865-M4S10	393	1	1	No	730770	80.4686	865-M6N10DA	395	1	1	No	731272	178.5742
865-M4S11	393	1	1	No	730787	82.0119	865-M6N10FA	396	1	1	No	731289	202.825
865-M4S12	393	1	1	No	730794	83.7756	865-M6S01DA	395	1	1	No	731296	152.1188
865-M4S13	393	1	1	No	730800	85.3188	865-M6S01FA	396	1	1	No	731319	175.4878
865-M4S14	393	1	1	No	730817	86.862	865-M6S02DA	395	1	1	No	731326	155.4257
865-M4S15	393	1	1	No	730824	88.4053	865-M6S02FA	396	1	1	No	731333	179.6765
865-M4S16	393	1	1	No	730831	90.169	865-M6S03DA	395	1	1	No	731340	158.7326
865-M4S17	394	1	1	No	730848	91.7122	865-M6S03FA	396	1	1	No	731364	184.0858
865-M4S18	394	1	1	No	730855	93.4759	865-M6S04DA	395	1	1	No	731371	162.0396
865-M4S19	394	1	1	No	730862	95.0191	865-M6S04FA	396	1	1	No	731395	186.2904
865-M4S20	394	1	1	No	730879	96.1214	865-M6S05DA	395	1	1	No	731401	165.3465
865-M4S21	394	1	1	No	730886	97.6647	865-M6S05FA	396	1	1	No	731418	189.5973
865-M4S22	394	1	1	No	730893	99.4284	865-M6S06DA	395	1	1	No	731425	167.992
865-M4S23	394	1	1	No	730909	100.9716	865-M6S06FA	396	1	1	No	731432	192.2429
865-M4S24	394	1	1	No	730916	102.7353	865-M6S07DA	395	1	1	No	731449	170.1967
865-M4S25	394	1	1	No	730923	104.2785	865-M6S07FA	396	1	1	No	731456	194.4475
865-M4S26	394	1	1	No	730930	106.0422	865-M6S08DA	395	1	1	No	731463	172.4013
865-M4S27	394	1	1	No	730947	107.5855	865-M6S08FA	396	1	1	No	731487	196.6521
865-M4S28	394	1	1	No	730954	109.3492	865-M6S09DA	395	1	1	No	731494	174.6059
865-M4S29	394	1	1	No	730961	111.1128	865-M6S09FA	396	1	1	No	731517	198.8567
865-M4S30	394	1	1	No	730978	112.8765	865-M6S10DA	395	1	1	No	731524	176.8105
865-M6CBDA	395	1	1	No	730985	145.5049	865-M6S10FA	396	1	1	No	731548	200.6204
865-M6CBF1A	396	1	1	No	730992	158.7326	865-M8CBDA	397	1	1	No	731555	156.528
865-M6CBFA	395	1	1	No	731005	156.528	865-M8CBF1A	397	1	1	No	731562	158.7326
865-M6N005DA	395	1	1	No	731012	77.1617	865-M8CBFA	397	1	1	No	731579	158.7326
865-M6N005F1A	396	1	1	No	731029	98.1056	865-M8N005DA	397	1	1	No	731586	119.0495
865-M6N005FA	395	1	1	No	731036	89.2871	865-M8N005F1A	397	1	1	No	731593	122.3564
865-M6N005SDA	395	1	1	No	731043	74.9571	865-M8N005FA	397	1	1	No	731609	121.2541

Item No	Page No	Min Qty	Case Qty	UPC Bar-Coded	UPC 6-Digit	Weight (lbs.)	Item No	Page No	Min Qty	Case Qty	UPC Bar-Coded	UPC 6-Digit	Weight (lbs.)
865-M8N005SDA	397	1	1	No	731616	119.0495	865-T4N00	400	1	1	No	732026	61.6
865-M8N005SF1A	397	1	1	No	731623	122.3564	865-T4N005	400	1	1	No	732033	28.65
865-M8N005SFA	397	1	1	No	731630	121.2541	865-T4N00B	400	1	1	No	732040	61.6
865-M8N00BDA	397	1	1	No	731647	229.2805	865-T4N10	399	1	1	No	732057	74.8
865-M8N00BF1A	397	1	1	No	731654	244.7128	865-T4N105S	399	1	1	No	732071	30.8
865-M8N00BFA	397	1	1	No	731661	242.5082	865-T4N10B	399	1	1	No	732088	66
865-M8N00DA	397	1	1	No	731678	229.2805	865-T4N15	399	1	1	No	732095	78.35
865-M8N00F1A	397	1	1	No	731685	244.7128	865-T4N155	399	1	1	No	732101	40.3
865-M8N00FA	397	1	1	No	731692	242.5082	865-T4N15B	399	1	1	No	732125	78.1
865-N3	387	1	1	No	324122	17.495	865-T4N20	399	1	1	No	732132	88.45
865-N5	387	1	1	No	324139	19.4185	865-T4N205	399	1	1	No	732149	42.55
865-N7	387	1	1	No	324146	21.271	865-T4N205S	399	1	1	No	732156	39.6
865-N9	387	1	1	No	324153	23.09	865-T4N20B	399	1	1	No	732163	85.45
865-NS1	388	1	1	Yes	744845	7.5	865-T4P5BL	399	1	1	No	732170	2.45
865-NSC	389	1	50	Yes	744852	0.25	865-T4S01	399	1	1	No	732187	61.45
865-RAKE	409	1	1	No	731722	1.35	865-T4S02	399	1	1	No	732194	64.05
865-RAKEP	409	1	1	No	731739	1.2	865-T4S03	399	1	1	No	732200	63.4
865-S1	387	1	1	No	324160	15.865	865-T4S04	399	1	1	No	732217	63.35
865-S15	388	1	100	Yes	710628	0.0595	865-T4S05	399	1	1	No	732224	64.8
865-S15	389	1	100	Yes	710628	0.0595	865-T4S06	399	1	1	No	732231	67.65
865-S2	387	1	1	No	323828	16.61	865-T4S07	399	1	1	No	732248	68.75
865-S3	387	1	1	No	324177	17.54	865-T4S08	399	1	1	No	732255	68.9
865-S4	387	1	1	No	324184	18.875	865-T4S09	399	1	1	No	732262	70.75
865-S5	387	1	1	No	323781	19.335	865-T4S10	399	1	1	No	732279	73.05
865-S6	387	1	1	No	324191	20.21	865-T4S11	399	1	1	No	732286	76.25
865-S7	387	1	1	No	324207	21.135	865-T4S12	399	1	1	No	732293	75.85
865-S8	387	1	1	No	323798	21.88	865-T4S13	399	1	1	No	732309	77.3
865-S9	387	1	1	No	324214	22.715	865-T4S14	400	1	1	No	732316	80.9
865-SHOVEL	394	1	1	No	731746	-	865-T4S15	400	1	1	No	732323	73.85
865-SHOVEL	396	1	1	No	731746	-	865-T4S16	400	1	1	No	732330	82.05
865-SHOVEL	397	1	1	No	731746	-	865-T4S17	400	1	1	No	732347	85.45
865-SHOVEL	398	1	1	No	731746	-	865-T4S18	400	1	1	No	732354	84.25
865-SHOVEL	398	1	1	No	731746	-	865-T4S19	400	1	1	No	732361	83.4
865-SHOVEL	401	1	1	No	731746	-	865-T4S20	400	1	1	No	732378	89.35
865-T4CB	400	1	1	No	731807	82.9	865-T4S21	400	1	1	No	732385	92.35
865-T4DI5CL	399	1	1	No	731814	9.46	865-T4S22	400	1	1	No	732392	96.2
865-T4DI5CX	399	1	1	No	731821	7.9	865-T4S23	400	1	1	No	732408	100.25
865-T4GS5AS	399	1	1	No	731838	-	865-T4S24	400	1	1	No	732415	101.1
865-T4GS5CM	399	1	1	No	731869	-	865-T4S25	400	1	1	No	732422	101.35
865-T4GS5CP	399	1	1	No	731876	-	865-T4S26	400	1	1	No	732439	103.75
865-T4GS5CS	399	1	1	No	731883	4.75	865-T4S27	400	1	1	No	732446	104.4
865-T4GSA5P	399	1	1	No	731890	-	865-T4S28	400	1	1	No	732453	104.75
865-T4GSAP	399	1	1	No	731906	-	865-T4S29	400	1	1	No	732460	105.9
865-T4GSAS	399	1	1	No	731913	4.55	865-T4S30	400	1	1	No	732477	107.45
865-T4GSCM	399	1	1	No	731968	-	865-TEC	388	1	1	No	742117	2
865-T4GSCP	399	1	1	No	731975	-	865-TEO	388	1	1	No	742124	3
865-T4GSCS	399	1	1	No	731982	10.95	865-TNB	388	1	1	No	744951	15
865-T4LP003	400	1	1	No	731999	33	865-TNCBDS	388	1	1	No	742094	120
865-T4LP0053	400	1	1	No	732002	16.5	865-TNCBFM	388	1	1	No	742100	130
865-T4LP00B03	400	1	1	No	732019	33	865-TNDS	388	1	1	No	742070	107.14

Supply

Drainage

Support

Specialties

Appendix

# Numerical Index

Supply

Drainage

Support

Specialties

Appendix

Item No	Page No	Min Qty	Case Qty	UPC Bar-Coded	UPC 6-Digit	Weight (lbs.)	Item No	Page No	Min Qty	Case Qty	UPC Bar-Coded	UPC 6-Digit	Weight (lbs.)
865-TNFM	388	1	1	No	742087	147.7	868-1508	283	1	1	Yes	375339	31.05
865-TOOL	394	1	1	No	732934	-	868-15AD	283	1	1	Yes	709332	2.45
865-TOOL	396	1	1	No	732934	-	868-15AD	288	1	1	Yes	709332	2.45
865-TOOL	397	1	1	No	732934	-	868-15CD	283	1	1	Yes	375391	6.79
865-TOOL	401	1	1	No	732934	-	868-15CD	288	1	1	Yes	375391	6.79
865-TOOLP	401	1	1	No	723550	-	868-15EXT	283	1	1	Yes	375322	26.55
866-2I	435	1	4	Yes	301055	5.375	868-15EXT	288	1	1	Yes	375322	26.55
866-2PPK	435	5	5	Yes	301062	0.66	868-15S	283	1	1	Yes	375872	8.333
866-2S	438	1	20	Yes	356369	0.2248	868-15S2	288	1	1	Yes	310002	27
866-34PPK	435	5	5	Yes	301093	2.14	868-15SH	283	1	10	Yes	311139	1.1192
866-3I	435	1	4	Yes	301086	11.1125	868-15SH	288	1	10	Yes	311139	1.1192
866-3S	438	1	20	Yes	301192	0.69	868-15U	283	1	5	Yes	375902	8.42
866-S2I	438	1	10	Yes	301154	1.26	868-15U	288	1	5	Yes	375902	8.42
866-S3I	438	1	10	Yes	301185	2.24	868-15WD	283	1	5	Yes	375384	12.2
867-30PK	461	25	25	Yes	315304	0.27	868-2010	287	1	1	Yes	375308	79.35
867-35PK	461	25	25	Yes	315359	0.24	868-2012	287	1	1	Yes	375292	83.505
867-A2	364	2	2	Yes	351289	2.8422	868-20CD	287	1	1	Yes	375278	18.6495
867-A2M	364	2	2	Yes	355904	6.849	868-20S	287	1	1	Yes	375155	26.25
867-A3	364	2	2	Yes	303264	2.9422	868-20SH	287	1	1	Yes	322647	2.4916
867-A3M	364	2	2	Yes	355911	6.949	868-20U	287	1	1	Yes	375193	18.54
867-A4	364	2	2	Yes	351296	2.625	868-20WD	287	1	1	Yes	375216	21.812
867-A4M	364	2	2	Yes	355928	6.999	868-523	283	1	1	No	719218	32.25
867-C	364	1	25	Yes	339188	1.582	868-523A	284	1	1	No	726025	14.25
867-C	366	1	25	Yes	339188	1.582	868-523B	284	1	1	No	719263	27.46
867-DI2	365	1	1	Yes	204905	36.48	868-524	283	1	1	No	719225	30.95
867-DI3	365	1	1	Yes	204912	36.1	868-524A	284	1	1	No	726049	26.35
867-DI4	365	1	1	Yes	204929	37.245	868-524B	284	1	1	No	719270	26.05
867-HC	364	1	5	Yes	355935	0.6542	868-526	283	1	1	No	719232	31.65
867-HC	366	1	5	Yes	355935	0.6542	868-526A	284	1	1	No	726063	1.76
867-HD	364	1	5	Yes	351302	0.5883	868-526B	284	1	1	No	719287	26.15
867-L3AP	366	1	1	Yes	374554	6.405	868-528	283	1	1	No	719249	31.101
867-L3PP	366	1	1	Yes	374585	7.05	868-528A	284	1	1	No	726087	9.41
867-L4AP	366	1	1	Yes	374516	8.5416	868-528B	284	1	1	No	719294	26.311
867-L4PP	366	1	1	Yes	374509	7	868-5A	447	10	10	Yes	303356	0.4876
867-MC	364	1	1	Yes	355942	3.6992	868-5AD	284	1	1	No	734426	2.45
867-MC	366	1	1	Yes	355942	3.6992	868-5AD	289	1	1	No	734426	2.45
867-MD	364	1	5	Yes	351319	4.6261	868-5CD	284	1	1	Yes	734877	6.79
867-P2	364	2	2	Yes	303301	3.0352	868-5CD	289	1	1	Yes	734877	6.79
867-P2M	364	2	2	Yes	355959	7.179	868-5EXT	284	1	1	Yes	734891	26.55
867-P3	364	2	2	Yes	339034	3.2872	868-5EXT	289	1	1	Yes	734891	26.55
867-P3M	364	2	2	Yes	303332	7.294	868-5P	447	10	10	Yes	303509	0.5476
867-P4	364	2	2	Yes	339041	3.3572	868-5PD	284	1	1	Yes	734884	0.75
867-P4M	364	2	2	Yes	305244	7.364	868-5PD	289	1	1	Yes	734884	0.75
867-UM	364	1	1	Yes	375865	0.73	868-5S	284	1	1	Yes	734921	8.33
867-UM	366	1	1	Yes	375865	0.73	868-5S2	284	1	1	Yes	743480	27
868-123	286	1	1	No	719645	24.319	868-5S2	289	1	1	Yes	743480	27
868-124	286	1	1	No	719652	24.466	868-5SH	284	1	50	Yes	734938	0.46
868-1503	283	1	1	Yes	376763	32.5623	868-5SH	289	1	50	Yes	734938	0.46
868-1504	283	1	1	Yes	376534	33	868-5U	284	1	1	Yes	734945	8.42
868-1506	283	1	1	Yes	375919	33.2	868-5U	289	1	1	Yes	734945	8.42



Item No	Page No	Min Qty	Case Qty	UPC Bar-Coded	UPC 6-Digit	Weight (lbs.)	Item No	Page No	Min Qty	Case Qty	UPC Bar-Coded	UPC 6-Digit	Weight (lbs.)
868-5WD	284	1	1	Yes	734952	12.2	868-I3M	285	1	1	Yes	356017	12.2951
868-7A	447	10	10	Yes	376671	0.3861	868-I4	285	1	2	Yes	351234	11.7475
868-7P	447	10	10	Yes	376657	0.4272	868-I4M	285	1	2	Yes	350947	12.9451
868-823	286	1	1	No	719737	9.645	868-I6	285	1	2	Yes	350954	12.0475
868-824	286	1	1	No	719744	9.773	868-I6M	285	1	1	Yes	356024	13.7473
868-9A	447	10	10	Yes	303370	0.5026	868-M123	286	1	1	No	719706	31.269
868-9P	447	10	10	Yes	305145	0.43	868-M124	286	1	1	No	719713	31.416
868-A3	363	1	2	Yes	355966	4.7475	868-MC	363	1	10	Yes	356031	1.6004
868-A3M	363	1	2	Yes	355973	5.9451	868-MCCQ	285	1	10	Yes	356031	0.16
868-A4	363	1	2	Yes	355980	5.2475	868-MD	363	1	5	Yes	350961	1.9009
868-A4M	363	1	2	Yes	355997	6.4451	868-MDCQ	285	1	5	Yes	350961	1.9009
868-A6	363	1	2	Yes	303394	5.4975	868-N3F	293	1	1	Yes	327956	4.0968
868-A6M	363	1	2	Yes	356000	6.6951	868-N3H	293	1	1	Yes	329486	3.75
868-C	363	1	5	Yes	303400	2.0679	868-N3S	293	1	1	Yes	724588	3.35
868-CCQ	285	1	5	Yes	303400	0.4136	868-N4F	293	1	1	Yes	327963	5.25
868-D123	289	1	1	No	743497	65	868-N4H	293	1	1	Yes	327970	4.85
868-D124	289	1	1	No	743503	65	868-N4S	293	1	1	Yes	724595	4.05
868-D1503	288	1	1	Yes	311252	106.5804	868-N6F	293	1	1	Yes	327987	7.366
868-D1504	288	1	1	Yes	311269	110.1804	868-N6H	293	1	1	Yes	327994	6.9
868-D1506	288	1	1	Yes	311276	108.1804	868-N6S	293	1	1	Yes	724601	6
868-D1508	288	1	1	Yes	311283	108.68	868-N8F	293	1	1	Yes	328007	10.4804
868-D523	288	1	1	No	719416	65.478	868-N8H	293	1	1	Yes	328014	11
868-D523A	289	1	1	No	726117	79.5	868-N8S	293	1	1	Yes	724618	7.9
868-D523B	289	1	1	No	719461	56.9	868-NS3	293	1	1	Yes	328021	0.09
868-D524	288	1	1	No	719423	31.3667	868-NS4	293	1	50	Yes	328038	0.2846
868-D524A	289	1	1	No	726124	61.048	868-NS6	293	1	50	Yes	328045	0.16
868-D524B	289	1	1	No	719478	55.018	868-NS8	293	1	1	Yes	328052	0.4296
868-D526	288	1	1	No	719430	39.7	868-P3	363	1	2	Yes	305183	5.0475
868-D526A	289	1	1	No	726131	90.9333	868-P3M	363	1	2	Yes	350978	6.2451
868-D526B	289	1	1	No	719485	34.503	868-P4	363	1	2	Yes	303431	4.31
868-D528	288	1	1	No	719447	64.274	868-P4M	363	1	2	Yes	350985	6.4451
868-D528A	289	1	1	No	726148	60.644	868-P6	363	1	2	Yes	305190	4.4575
868-D528B	289	1	1	No	719492	54.614	868-P6M	363	1	2	Yes	350992	5.8529
868-D823	290	1	1	No	723987	20.74	868-Q623I	291	1	1	No	724007	67.35
868-D824	290	1	1	No	723994	24.65	868-Q623IN	291	1	1	No	724083	80.69
868-E	363	1	5	Yes	303417	1.751	868-Q624I	291	1	1	No	724014	65.4
868-ECQ	285	1	5	Yes	303417	0.3502	868-Q624IN	291	1	1	No	726865	78.74
868-F123	286	1	1	No	719676	-	868-Q626I	291	1	1	No	724021	65.685
868-F124	286	1	1	No	719683	32.166	868-Q626IN	291	1	1	No	724090	80.955
868-F523	284	1	1	No	719515	47.85	868-Q628I	291	1	1	No	724038	66.201
868-F523A	285	1	1	No	726162	21.26	868-Q628IN	291	1	1	No	724106	79.541
868-F523B	284	1	1	No	719553	21.26	868-R623I	291	1	1	No	724113	50.4
868-F524	284	1	1	No	719522	47.05	868-R623IN	291	1	1	No	724120	60.49
868-F524A	285	1	1	No	726179	20.46	868-R624I	291	1	1	No	724137	50.21
868-F524B	284	1	1	No	719560	53.679	868-R624IN	291	1	1	No	724144	58.54
868-F526	284	1	1	No	719539	28.35	868-R626I	291	1	1	No	724151	48.735
868-F526A	285	1	1	No	726186	1.76	868-R626IN	291	1	1	No	724168	58.825
868-F526B	284	1	1	No	719577	1.76	868-R628I	291	1	1	No	724175	49.251
868-HD	363	1	5	Yes	351043	0.514	868-R628IN	291	1	1	No	724182	59.341
868-I3	285	1	2	Yes	351258	11.0975	868-S	363	1	10	Yes	305091	1.8

Supply

Drainage

Support

Specialties

Appendix

# Numerical Index

Supply

Drainage

Support

Specialties

Appendix

Item No	Page No	Min Qty	Case Qty	UPC Bar-Coded	UPC 6-Digit	Weight (lbs.)	Item No	Page No	Min Qty	Case Qty	UPC Bar-Coded	UPC 6-Digit	Weight (lbs.)
868-S3A	292	1	1	Yes	714046	17.7	<b>870-810</b>	376	<b>5</b>	5	Yes	303875	0.765
868-S3F	292	1	1	Yes	714053	17.4	<b>870-812</b>	376	<b>5</b>	5	Yes	303882	1.115
868-S4A	292	1	1	Yes	714060	14.55	<b>870-8PK1</b>	377	<b>5</b>	80	Yes	703040	0.65
868-S4F	292	1	1	Yes	714077	14.75	<b>870-93</b>	310	10	10	Yes	303899	0.125
868-S6A	292	1	1	Yes	714084	35.8	<b>870-94</b>	310	10	10	Yes	303905	0.4111
868-S6F	292	1	1	Yes	714091	-	<b>870-95</b>	310	10	10	Yes	303912	0.33
868-SCQ	285	1	10	Yes	305091	0.18	<b>870-96</b>	310	10	10	Yes	303929	0.5743
868-V234	293	1	1	Yes	713452	6.85	<b>870-98</b>	310	10	10	Yes	303936	0.825
868-WD	363	1	1	Yes	310521	3.9418	<b>870-B</b>	377	<b>25</b>	100	No	303943	0.0846
868-WDCQ	285	1	1	Yes	310521	3.9418	<b>870-B3</b>	377	<b>10</b>	10	Yes	303950	0.3377
869-23	454	1	1	Yes	303479	2.35	<b>870-B4</b>	377	<b>10</b>	10	Yes	303967	0.4173
869-2A	454	1	8	Yes	305084	0.634	<b>870-B5</b>	377	<b>1</b>	10	Yes	303974	0.6242
869-2P	454	1	8	Yes	306005	0.8126	<b>870-B6</b>	377	<b>1</b>	10	Yes	303981	0.4093
869-2PS	454	1	1	Yes	713995	3.8	<b>870-B8</b>	377	<b>1</b>	10	Yes	303998	0.62
869-60	454	1	10	Yes	303721	0.04	<b>871-16</b>	376	25	25	Yes	304001	0.157
869-61	454	1	10	Yes	303738	0.63	<b>871-18</b>	376	10	10	Yes	304018	0.35
869-6P	454	1	1	No	306203	9.8	<b>871-4</b>	376	<b>25</b>	25	Yes	313041	0.0716
869-6P1	454	1	2	Yes	303783	2.3025	<b>871-6</b>	376	<b>25</b>	25	Yes	313065	0.1392
869-S3A	453	4	4	Yes	313638	2.1134	<b>871-8</b>	376	<b>10</b>	10	Yes	313089	0.2798
869-S3APK	453	2	2	Yes	313645	2.4649	<b>872-16</b>	376	25	25	Yes	304056	0.2326
869-S3AS	453	1	1	Yes	313652	9.6	<b>872-18</b>	376	10	10	Yes	304032	0.27
869-S3P	453	4	4	Yes	313669	2.6088	<b>872-4</b>	376	25	25	Yes	356413	0.0902
869-S3PPK	453	2	2	Yes	313676	3.0029	<b>872-6</b>	376	25	25	Yes	313362	0.198
869-S3PS	453	1	1	Yes	313683	10.135	<b>872-8</b>	376	10	10	Yes	313386	0.2624
869-S4A	453	4	4	Yes	313690	1.691	<b>873-10</b>	310	<b>1</b>	1	No	727282	-
869-S4ADB	453	1	1	Yes	313706	2.369	<b>873-240P</b>	377	<b>1</b>	10	Yes	369666	0.2271
869-S4APK	453	2	2	Yes	313713	3.0925	<b>873-26</b>	310	<b>1</b>	1	Yes	718426	0.3797
869-S4AS	453	1	1	Yes	313720	10.65	<b>873-350P</b>	377	<b>1</b>	10	Yes	369765	0.345
869-S4P	453	4	4	Yes	313737	3.3825	<b>873-356</b>	310	<b>1</b>	1	Yes	718457	0.98
869-S4PDB	453	1	1	Yes	313744	2.9249	<b>873-36</b>	310	<b>1</b>	1	Yes	718440	0.8448
869-S4PPK	453	2	2	Yes	313751	3.73	<b>873-460P</b>	377	<b>1</b>	10	Yes	369772	0.7561
869-S4PS	453	1	1	Yes	313768	11.245	<b>873-48</b>	310	<b>1</b>	1	Yes	718464	2.15
869-SF3	453	10	10	Yes	313775	0.3235	<b>873-6</b>	310	<b>1</b>	1	Yes	727275	-
869-SF4	453	10	10	Yes	313782	0.4367	<b>873-610</b>	310	<b>1</b>	1	Yes	718471	4.05
869-SSK	453	1	1	Yes	313805	2.066	<b>873-8</b>	310	<b>1</b>	25	Yes	727268	-
869-SSL	453	4	4	Yes	313812	1.2227	<b>873-810</b>	310	<b>1</b>	1	Yes	718488	6.5
869-SV4	439	10	10	Yes	344045	2.0452	<b>874-1</b>	377	<b>25</b>	1000	No	304421	0.0173
869-SVLB	453	10	10	Yes	313829	0.4411	<b>874-1C</b>	377	<b>25</b>	1000	No	304278	0.0203
869-SVLW	453	10	10	Yes	313836	0.4279	<b>874-1W</b>	377	<b>25</b>	100	No	306791	0.0227
869-V34	461	4	4	Yes	302076	0.6352	<b>874-2</b>	377	<b>25</b>	1000	No	304261	0.0274
869-V4	437	1	4	Yes	344021	7.8625	<b>874-2N</b>	377	<b>50</b>	200	No	722317	0.0052
870-2CM	377	25	25	Yes	303813	0.0574	<b>874-3C</b>	377	<b>25</b>	500	No	304179	0.033
870-3	376	25	25	Yes	305237	0.068	<b>874-3W</b>	377	<b>25</b>	1000	No	304254	0.0206
870-3PK1	377	<b>5</b>	120	Yes	312136	0.1	<b>874-4</b>	377	<b>25</b>	500	No	304193	0.0457
870-4	376	25	25	Yes	306708	0.1168	<b>874-4C</b>	377	<b>25</b>	500	No	304209	0.0538
870-4PK1	377	<b>5</b>	120	Yes	312143	0.15	<b>874-4W</b>	377	<b>25</b>	100	No	304216	0.0554
870-5	376	25	25	Yes	304094	0.17	<b>874-6</b>	377	<b>25</b>	1000	No	304223	0.0681
870-6	376	25	25	Yes	303851	0.2449	<b>874-6C</b>	377	<b>25</b>	100	No	304230	0.0706
870-6PK1	377	<b>5</b>	80	Yes	312167	0.3	<b>874-6W</b>	377	<b>25</b>	100	No	351012	0.0709
870-8	376	10	10	Yes	303868	0.6369	<b>875-2A</b>	378	<b>20</b>	20	Yes	314048	0.075

Item No	Page No	Min Qty	Case Qty	UPC Bar-Coded	UPC 6-Digit	Weight (lbs.)	Item No	Page No	Min Qty	Case Qty	UPC Bar-Coded	UPC 6-Digit	Weight (lbs.)
875-2P	378	<b>20</b>	20	Yes	314024	0.1107	<b>878-15PK</b>	379	<b>25</b>	25	Yes	307118	0.0485
875-3A	378	<b>20</b>	20	Yes	314086	0.1719	<b>878-20</b>	379	<b>25</b>	25	No	304544	0.0648
875-3P	378	<b>20</b>	20	Yes	314062	0.1903	<b>878-20PK</b>	379	<b>25</b>	25	Yes	307217	0.065
875-4A	378	<b>20</b>	20	Yes	314123	0.2196	<b>878-25</b>	379	<b>25</b>	25	No	304551	0.0857
875-4P	378	<b>20</b>	20	Yes	265913	0.2422	<b>878-30</b>	379	<b>25</b>	25	No	304568	0.1138
875-8230P	378	<b>1</b>	10	Yes	304308	0.3192	<b>878-30PK</b>	379	<b>25</b>	25	Yes	307415	0.123
875-8340P	378	<b>1</b>	10	Yes	304315	0.6519	<b>878-35</b>	379	<b>25</b>	25	No	304575	0.1396
875-83AN	378	12	12	Yes	727022	0.6292	<b>878-35PK</b>	379	<b>25</b>	25	Yes	307514	0.1485
875-83PN	378	12	12	Yes	727046	0.775	<b>878-40</b>	379	<b>25</b>	25	No	304582	0.1708
875-8450P	378	<b>1</b>	10	Yes	304322	0.9435	<b>878-40PK</b>	379	<b>25</b>	25	Yes	307613	0.176
875-84AN	378	<b>12</b>	12	Yes	724366	1.0458	<b>878-50</b>	379	25	25	No	304599	0.374
875-84PN	378	<b>12</b>	12	Yes	708380	1.1417	<b>878-60</b>	379	<b>8</b>	8	No	304605	0.4101
876-CS15	311	10	10	Yes	718594	0.155	<b>878-915</b>	380	10	20	No	356147	0.795
876-CS20	311	10	10	Yes	718600	0.19	<b>878-920</b>	380	10	10	No	351050	0.1372
876-CS25	311	10	10	Yes	718617	0.32	<b>878-930</b>	380	10	10	No	304636	0.288
876-CS30	311	10	10	Yes	718624	0.3133	<b>878-935</b>	380	10	20	No	356161	0.9201
876-CS35	311	10	10	Yes	718631	0.185	<b>878-940</b>	380	10	10	No	304643	0.474
876-CS40	311	10	10	Yes	718648	0.5294	<b>878-950</b>	380	10	10	No	351067	1.0247
876-CS60	311	10	10	Yes	718655	1.13	<b>878-960</b>	380	10	10	No	304650	1.1586
876-CS80	311	10	10	Yes	718662	2.13	<b>878-980</b>	380	10	10	No	351074	2.343
876-RS15	311	10	10	Yes	718501	0.115	<b>878-S15</b>	380	<b>25</b>	25	No	329134	0.046
876-RS20	311	10	10	Yes	718518	0.16	<b>878-S20</b>	380	<b>25</b>	25	No	329158	0.058
876-RS25	311	10	10	Yes	718525	0.235	<b>878-S30</b>	380	<b>25</b>	25	No	329141	0.13
876-RS30	311	10	10	Yes	718532	0.295	<b>878-S40</b>	380	<b>25</b>	25	No	329165	0.164
876-RS35	311	10	10	Yes	718549	0.405	<b>879-015</b>	379	<b>25</b>	25	No	304667	0.0414
876-RS40	311	10	10	Yes	718556	0.485	<b>879-015PK</b>	379	<b>25</b>	25	Yes	308108	0.0428
876-RS50	311	10	10	Yes	728555	0.775	<b>879-020</b>	379	<b>25</b>	25	No	304674	0.0585
876-RS60	311	10	10	Yes	718563	1.13	<b>879-020PK</b>	379	<b>25</b>	25	Yes	308207	0.0599
876-RS80	311	10	10	Yes	718570	2.185	<b>879-025</b>	379	<b>25</b>	25	No	356178	0.0689
876-SL15	311	10	10	Yes	718686	0.255	<b>879-025PK</b>	379	<b>25</b>	25	Yes	308306	0.082
876-SL20	311	10	10	Yes	718693	0.37	<b>879-030</b>	379	<b>25</b>	25	No	304681	0.0898
876-SL25	311	10	10	Yes	718709	0.435	<b>879-030PK</b>	379	<b>25</b>	25	Yes	308405	0.1162
876-SL30	311	10	40	Yes	718716	0.835	<b>879-035</b>	379	<b>25</b>	25	No	356185	0.1391
876-SL35	311	10	10	Yes	718723	0.98	<b>879-035PK</b>	379	<b>25</b>	25	Yes	308504	0.146
876-SL40	311	10	10	Yes	718730	2.67	<b>879-040</b>	379	<b>25</b>	25	No	304698	0.1651
876-SL60	311	10	10	Yes	718747	2.76	<b>879-040PK</b>	379	<b>25</b>	25	Yes	308603	0.1683
876-SL80	311	10	10	Yes	718754	5.185	<b>879-15</b>	379	<b>25</b>	25	No	304704	0.0481
878-015	379	<b>25</b>	25	No	304483	0.04	<b>879-15PK</b>	379	<b>25</b>	25	Yes	308115	0.0495
878-015PK	379	<b>25</b>	25	Yes	307101	0.055	<b>879-20</b>	379	<b>25</b>	25	No	304711	0.0636
878-020	379	<b>25</b>	25	No	304490	0.0585	<b>879-20PK</b>	379	<b>25</b>	25	Yes	308214	0.065
878-020PK	379	<b>25</b>	25	No	307200	0.0599	<b>879-25</b>	379	<b>25</b>	25	No	356192	0.0857
878-025	379	<b>25</b>	25	No	350930	0.0689	<b>879-30</b>	379	<b>25</b>	25	No	304728	0.1138
878-025PK	379	<b>25</b>	25	Yes	307309	0.084	<b>879-30PK</b>	379	<b>25</b>	25	Yes	308412	0.123
878-030	379	<b>25</b>	25	No	304506	0.1054	<b>879-35</b>	379	<b>25</b>	25	No	304735	0.137
878-030PK	379	<b>25</b>	25	Yes	307408	0.1158	<b>879-35PK</b>	379	<b>25</b>	25	Yes	308511	0.1459
878-035	379	<b>25</b>	25	No	304513	0.1391	<b>879-40</b>	379	<b>25</b>	25	No	304742	0.1732
878-035PK	379	<b>25</b>	25	Yes	307507	0.148	<b>879-40PK</b>	379	25	25	Yes	308610	0.1764
878-040	379	<b>25</b>	25	No	304520	0.1651	<b>879-50</b>	379	20	20	No	304759	0.2944
878-040PK	379	<b>25</b>	25	Yes	307606	0.1703	<b>879-60</b>	379	<b>8</b>	8	No	304766	0.7777
878-15	379	<b>25</b>	25	No	304537	0.0471	<b>879-S15</b>	380	<b>25</b>	25	No	329127	0.046

Supply

Drainage

Support

Specialties

Appendix

# Numerical Index

Supply

Drainage

Support

Specialties

Appendix

Item No	Page No	Min Qty	Case Qty	UPC Bar-Coded	UPC 6-Digit	Weight (lbs.)	Item No	Page No	Min Qty	Case Qty	UPC Bar-Coded	UPC 6-Digit	Weight (lbs.)
879-S20	380	<b>25</b>	25	No	329110	0.056	881-3	472	<b>50</b>	500	No	356406	0.0266
879-S30	380	<b>25</b>	25	No	329103	0.134	881-4	472	<b>50</b>	500	No	302441	0.0546
879-S40	380	<b>25</b>	25	No	329097	0.182	881-510	470	1	1	No	566492	1.76
880	461	25	25	No	304773	0.5412	881-52	470	1	5	No	566485	0.92
880-012	472	<b>100</b>	500	No	302816	0.0466	881-53	470	1	5	No	566478	1.64
880-01A	472	<b>50</b>	500	No	327307	0.0363	881-54	470	1	1	No	566621	3.2555
880-01P	472	<b>50</b>	500	No	327314	0.0471	881-56	470	1	1	No	566591	9.7836
880-02A	472	<b>25</b>	500	No	327321	0.0519	881-58	470	1	1	No	566607	15.3662
880-02P	472	<b>25</b>	500	No	327345	0.0663	882-1	467	10	10	Yes	302212	0.1765
880-034	472	<b>50</b>	250	No	302830	0.1262	882-105	477	1	6	No	507594	0.9333
880-03A	472	<b>20</b>	200	No	327352	0.0844	882-110	477	1	6	No	507600	0.8034
880-03P	472	<b>20</b>	200	No	327369	0.1058	882-115	467	1	25	Yes	308726	0.3298
880-04A	472	<b>25</b>	100	No	327376	0.131	882-1P	467	10	10	No	351081	0.426
880-04P	472	<b>25</b>	100	No	327383	0.169	882-2	467	10	10	Yes	302229	0.2426
880-1	472	25	25	No	302311	0.15	882-2P	467	10	10	No	305176	0.4566
880-2	472	25	25	No	302328	0.238	882-3	467	10	10	Yes	302236	0.38
880-3	472	25	25	No	302335	0.356	882-35	467	10	10	Yes	302298	0.4837
880-4	472	25	25	No	356390	0.378	882-3P	467	10	10	No	305220	0.6353
880-81	471	<b>25</b>	200	No	304841	0.0255	882-4	467	10	10	Yes	302243	0.4837
880-81C	471	<b>25</b>	200	No	304858	0.0253	882-41	467	10	10	Yes	302304	0.6677
880-81PK	471	50	50	Yes	303035	0.0303	882-4P	467	10	10	No	351098	0.8817
880-82	471	<b>25</b>	100	No	304872	0.0393	882-647	473	<b>24</b>	120	Yes	331014	0.085
880-82C	471	<b>25</b>	100	No	304889	0.035	882-647W	473	<b>1</b>	20	No	715470	-
880-82PK	471	50	50	Yes	303073	0.0331	882-95	470	1	30	No	305275	1.066
880-83	471	<b>10</b>	50	No	304902	0.0697	882-96	470	1	30	No	305282	1.2767
880-83C	471	<b>10</b>	50	No	304919	0.0693	882-98	470	1	12	No	305299	2.033
880-83PK	471	25	25	Yes	303080	0.0684	882-CS202	467	10	100	No	357557	0.1144
880-84	471	<b>10</b>	50	No	304933	0.0977	882-CS302	467	10	100	No	357540	0.2241
880-84C	471	<b>10</b>	50	No	304940	0.0984	882-CS402	467	10	100	No	357533	0.4112
880-84PK	471	25	25	Yes	303103	0.0967	882-EB152	467	10	100	No	357526	0.0197
881-01-10	470	1	1	No	566553	5.3837	882-EB220	467	10	100	No	357519	0.079
881-01-2	470	<b>5</b>	5	Yes	566546	0.1508	882-EB320	467	10	100	No	357502	0.3577
881-01-3	470	<b>5</b>	5	Yes	566539	0.2925	882-EB350	467	10	100	No	357496	0.4285
881-01-4	470	<b>5</b>	5	Yes	566522	0.5159	882-EB420	467	10	100	No	357489	0.5394
881-01-6	470	<b>1</b>	5	Yes	566515	0.544	882-EHPG	477	1	1	Yes	305336	3
881-01-8	470	<b>2</b>	2	Yes	566508	2.8605	882-EL23	471	1	1	Yes	305343	2.15
881-02A	471	1	10	No	304964	0.6	882-EL34	471	1	1	Yes	305350	4.19
881-02A	477	1	10	No	304964	0.6	882-EL46	471	1	1	Yes	305367	4.28
881-02FP	471	<b>100</b>	1000	No	304971	0.0017	882-ES12	471	1	1	Yes	305374	0.43
881-02H	471	1	25	No	304988	0.4189	882-ES23	471	1	1	Yes	305381	0.55
881-1	472	<b>100</b>	1000	No	302410	0.0084	882-ES34	471	1	1	Yes	305398	0.7
881-10	471	<b>25</b>	200	No	305008	0.0171	882-ES46	471	1	1	Yes	305404	2.8406
881-10C	471	<b>25</b>	200	No	305015	0.0171	882-HEXKEY1	469	1	50	Yes	739100	7
881-12	471	<b>25</b>	100	No	305022	0.0256	882-RTEX35	469	10	10	Yes	739117	1.4
881-12C	471	<b>25</b>	100	No	305039	0.0245	882-RTEX40	469	10	10	Yes	739124	1.85
881-13	471	<b>10</b>	50	No	305046	0.0464	882-RTPCS15	468	10	10	Yes	739162	1.6
881-13C	471	<b>10</b>	50	No	305053	0.0464	882-RTPCS20	468	10	10	Yes	739179	0.2
881-14	471	<b>10</b>	50	No	305060	0.063	882-RTPCS25	468	10	10	Yes	739186	2.74
881-14C	471	<b>10</b>	50	No	305077	0.0637	882-RTPCS30	468	10	10	Yes	739193	0.36
881-2	472	<b>100</b>	1000	No	302427	0.0133	882-RTPCS35	468	10	10	Yes	739209	0.424

Item No	Page No	Min Qty	Case Qty	UPC Bar-Coded	UPC 6-Digit	Weight (lbs.)	Item No	Page No	Min Qty	Case Qty	UPC Bar-Coded	UPC 6-Digit	Weight (lbs.)
882-RTPCS40	468	10	10	Yes	739216	0.455	882-ST602	467	10	10	No	357427	0.9758
882-RTPCX15	469	10	10	Yes	739223	-	882-ST802	467	10	10	No	357410	2.0576
882-RTPCX20	469	10	10	Yes	739230	-	882-TT2	470	1	48	Yes	305411	0.45
882-RTPCX25	469	10	10	Yes	739247	-	882-TT3	470	1	18	Yes	305428	1.2024
882-RTPCX30	469	10	10	Yes	739254	-	882-TT4	470	1	8	Yes	305435	1.3
882-RTPCX35	469	10	10	Yes	739261	-	883-AT	443	<b>25</b>	25	Yes	303097	0.6063
882-RTPCX40	469	10	10	Yes	739278	10.17	883-ATPK	443	8	8	Yes	303097	0.6442
882-RTPFC15	468	10	10	Yes	739285	-	883-PT	443	<b>25</b>	25	Yes	303059	0.741
882-RTPFC20	468	10	10	Yes	739292	4.13	883-PTPK	443	8	8	Yes	303059	0.8142
882-RTPFC25	468	10	10	Yes	739308	0.53	884-ATM	443	<b>24</b>	24	Yes	303189	0.6952
882-RTPFC30	468	10	10	Yes	739315	-	884-ATMPK	443	8	8	Yes	303189	0.7256
882-RTPFC35	468	10	10	Yes	739322	-	884-PTM	443	<b>24</b>	24	Yes	303141	0.8249
882-RTPFC40	468	10	10	Yes	739339	-	884-PTMPK	443	8	8	Yes	303141	0.9662
882-RTPHH15	468	10	10	Yes	739346	1.62	886-411	448	20	20	Yes	303523	0.3306
882-RTPHH20	468	10	10	Yes	739353	-	886-411	635	20	20	Yes	303523	0.3306
882-RTPHH25	468	10	10	Yes	739360	6.85	886-4A	444	<b>25</b>	25	Yes	305510	0.5362
882-RTPHH30	468	10	10	Yes	739377	2.95	886-4AM	444	25	25	Yes	356635	0.7249
882-RTPHH35	468	10	10	Yes	739384	0.415	886-4AMSPK	444	6	6	Yes	303691	0.6617
882-RTPHH40	468	10	10	Yes	739391	-	886-4ATM	443	25	25	Yes	352057	0.7216
882-RTPHX15	469	10	10	Yes	739407	-	886-4ATMPK	443	8	8	Yes	352057	0.7125
882-RTPHX20	469	10	10	Yes	739414	-	886-4ATMSPK	443	8	8	Yes	352064	0.7056
882-RTPHX25	469	10	10	Yes	739421	-	886-4P	444	<b>25</b>	25	Yes	303608	0.665
882-RTPHX30	469	10	10	Yes	739438	-	886-4PM	444	25	25	Yes	356628	0.7137
882-RTPHX35	469	10	10	Yes	739445	-	886-4PMSPK	444	6	6	Yes	303684	0.7192
882-RTPHX40	469	10	10	Yes	739452	-	886-4PPK	444	6	6	Yes	303745	0.6821
882-RTPSH25	469	10	10	Yes	739469	3.84	886-4PTM	443	25	25	Yes	352095	0.7786
882-RTPSH30	469	10	10	Yes	739476	-	886-4PTMPK	443	8	8	Yes	352095	0.805
882-RTPSH35	469	10	10	Yes	739483	4.47	886-4PTMSPK	443	8	8	Yes	352101	0.7988
882-RTPSH40	469	10	10	Yes	739490	0.075	886-A	444	<b>20</b>	20	Yes	303066	0.5152
882-RTPSP25	469	10	10	Yes	739506	-	886-APK	444	10	10	Yes	303066	0.4915
882-RTPSP30	469	10	10	Yes	739513	-	886-ATMS	443	<b>25</b>	25	Yes	352132	0.591
882-RTPSP35	469	10	10	Yes	739520	-	886-ATMSPK	443	8	8	Yes	352132	0.63
882-RTPSP40	469	10	10	Yes	739537	0.47	886-ER	448	<b>25</b>	25	Yes	303561	0.194
882-RTPSS15	468	10	10	Yes	739544	2.13	886-ER	635	<b>25</b>	25	Yes	303561	0.194
882-RTPSS20	468	10	10	Yes	739551	2.58	886-GA	445	5	5	Yes	380944	0.6767
882-RTPSS25	468	10	10	Yes	739568	4.75	886-GI	445	<b>5</b>	5	Yes	327499	3.05
882-RTPSS30	468	10	10	Yes	739575	6.1	886-GP	445	<b>5</b>	5	Yes	380937	0.6593
882-RTPSS35	468	10	10	Yes	739582	7.58	886-MR	448	<b>20</b>	20	Yes	303448	0.3704
882-RTPSS40	468	10	10	Yes	739599	8.63	886-MR	634	<b>20</b>	20	Yes	303448	0.3704
882-RTPTB15	468	10	10	Yes	739605	1.18	886-MRM	448	<b>8</b>	8	Yes	309105	0.65
882-RTPTB20	468	10	10	Yes	739612	1.65	886-MRM	634	<b>8</b>	8	Yes	309105	0.65
882-RTPTB25	468	10	10	Yes	739629	3.21	886-P	444	<b>20</b>	20	Yes	303028	0.6309
882-RTPTB30	468	10	10	Yes	739636	-	886-PPK	444	10	10	Yes	303028	0.6309
882-RTPTB35	468	10	10	Yes	739643	3.9	886-PT30	443	25	25	Yes	356611	0.5883
882-RTPTB40	468	10	10	Yes	739650	3.91	886-PTM30	443	25	25	Yes	352156	0.6276
882-ST152	467	10	100	No	357472	0.011	886-PTMS	443	<b>25</b>	25	Yes	352163	0.6868
882-ST202	467	10	100	No	357465	0.1388	886-PTMSPK	443	8	8	Yes	352163	0.6868
882-ST300	467	10	100	No	357458	0.3549	886-R	448	<b>20</b>	20	Yes	303424	0.2722
882-ST302	467	10	100	No	357441	0.2626	886-R	635	<b>20</b>	20	Yes	303424	0.2722
882-ST402	467	10	100	No	357434	0.415	886-RQ	448	20	20	Yes	378644	0.147

Supply

Drainage

Support

Specialties

Appendix

# Numerical Index

Supply

Drainage

Support

Specialties

Appendix

Item No	Page No	Min Qty	Case Qty	UPC Bar-Coded	UPC 6-Digit	Weight (lbs.)	Item No	Page No	Min Qty	Case Qty	UPC Bar-Coded	UPC 6-Digit	Weight (lbs.)
886-RQ	635	20	20	Yes	378644	0.147	900-01103C01005	647	<b>1</b>	1	Yes	443410	4.14
886-RQK	448	25	25	Yes	317445	0.5377	900-01103C02505	647	<b>1</b>	1	Yes	443373	9.4
886-RQK	635	25	25	Yes	317445	0.5377	900-01153C00101	647	<b>10</b>	10	Yes	443274	0.6
887-AM	444	25	25	Yes	303165	0.6336	900-01153C00201	647	<b>10</b>	10	Yes	443250	0.88
887-GPTMK	445	1	1	Yes	339270	1.736	900-01153C02005	647	<b>1</b>	1	Yes	443175	9.52
887-PM	444	<b>25</b>	25	Yes	303127	0.7295	900-01163C00101	647	<b>10</b>	10	Yes	443021	0.56
888-A	444	<b>20</b>	20	Yes	305633	0.4802	900-01163C00201	647	<b>10</b>	10	Yes	442994	1.04
888-AM	444	12	12	Yes	356581	0.775	900-01163C00501	647	<b>1</b>	1	Yes	442949	2.775
888-APK	444	10	10	Yes	303363	0.43	900-01163C01005	647	<b>1</b>	1	Yes	442901	6.11
888-ATM	443	<b>25</b>	25	Yes	352187	0.5328	900-01163N00101	649	<b>5</b>	5	Yes	442819	0.515
888-ATMPK	443	8	8	Yes	352187	0.6679	900-01164C01005	647	<b>1</b>	1	Yes	442697	8.85
888-GAM	445	6	6	Yes	378279	0.5333	900-01203C00101	647	<b>10</b>	10	Yes	442635	0.745
888-GPM	445	<b>6</b>	6	Yes	356598	0.91	900-01203C00201	647	<b>10</b>	10	Yes	442598	1.42
888-P	444	<b>20</b>	20	Yes	365132	0.6077	900-01203C00501	647	<b>1</b>	1	Yes	442567	3.7
888-PM	444	<b>12</b>	12	Yes	356574	1.0337	900-01203C01005	647	<b>1</b>	1	Yes	442512	7.5
888-PPK	444	10	10	Yes	303325	0.6865	900-01203N00101	649	<b>5</b>	5	Yes	442420	0.95
888-PTM	443	<b>25</b>	25	Yes	352200	0.6222	900-01206C00101	647	<b>10</b>	10	Yes	442369	1.415
888-PTMPK	443	8	8	Yes	352200	0.6438	900-01206C01005	647	<b>1</b>	1	Yes	442253	15
889-45AM	446	20	20	Yes	352217	0.7822	900-01253C00101	647	<b>10</b>	10	Yes	442208	0.99
889-45AMPK2	446	6	6	Yes	352217	0.8008	900-01253C00201	647	<b>5</b>	5	Yes	441836	1.64
889-45PM	446	<b>20</b>	20	Yes	305664	0.9508	900-01253C01005	647	<b>1</b>	1	Yes	441669	7.7
889-45PMPK2	446	6	6	Yes	303288	0.9809	900-01256C00101	647	<b>5</b>	5	Yes	441553	1.915
889-AOM	446	<b>20</b>	20	Yes	305671	0.911	900-01256C01005	647	<b>1</b>	1	Yes	441492	18.16
889-AOMPK	446	6	6	Yes	303240	0.9412	900-01306C00101	647	<b>10</b>	10	Yes	441423	2.095
889-AOTM	446	<b>20</b>	20	Yes	357403	0.8572	900-01306C00201	647	<b>5</b>	5	Yes	441393	3.43
889-GAOM	446	5	5	Yes	309068	0.94	900-01306C00755	647	<b>1</b>	1	Yes	441287	14.6
889-GPOM	446	<b>5</b>	5	Yes	313225	0.948	900-01306N00101	649	<b>5</b>	5	Yes	441249	2.05
889-POM	446	<b>20</b>	20	Yes	305688	1.0925	900-01406C00021	648	<b>5</b>	5	Yes	206077	0.59
889-POMPK	446	6	6	Yes	303226	1.1227	900-01406C00101	648	<b>5</b>	5	Yes	441157	2.84
889-POTM	446	<b>20</b>	20	Yes	357397	1.1555	900-01406C00505	648	<b>1</b>	1	Yes	441065	14.8
890-4BDPK	447	10	10	Yes	303554	0.8605	900-01406C01005	648	<b>1</b>	1	Yes	440921	28.5
890-4BPK	447	10	10	Yes	303547	0.6585	900-01508C00255	648	<b>1</b>	1	Yes	440815	14
890-I42	447	4	4	Yes	303622	3.425	900-01508C00504	648	<b>1</b>	1	Yes	440785	25.95
891-0312P	461	5	5	Yes	310323	0.7158	900-01608C00505	648	<b>1</b>	1	Yes	440716	33.25
891-033P	461	5	5	Yes	310330	0.9239	900-02106C00101	648	<b>10</b>	10	Yes	440662	0.9
891-0412P	461	5	5	Yes	310422	0.8763	900-02106C02505	648	<b>1</b>	1	Yes	440549	22.55
891-043P	461	5	5	Yes	310439	1.1318	900-02166C00101	648	<b>10</b>	10	Yes	440518	1.32
891-044P	461	5	5	Yes	310446	1.2128	900-02166C01505	648	<b>1</b>	1	Yes	440396	17.3
899-306R0009	665	<b>1</b>	1	Yes	444165	11	900-02206C00101	648	<b>10</b>	10	Yes	440341	1.425
900-01021C04005	647	<b>1</b>	1	Yes	444059	4.85	900-02206C01005	648	<b>1</b>	1	Yes	440273	15.2
900-01023C01005	647	<b>1</b>	1	Yes	443991	2.7	900-02256C00101	648	<b>10</b>	10	Yes	440228	1.79
900-01030C00101	647	<b>10</b>	10	Yes	443922	0.185	900-02256C00755	648	<b>1</b>	1	Yes	440181	14.05
900-01030C00201	647	<b>10</b>	10	Yes	443892	0.4	900-02306C00101	648	<b>10</b>	10	Yes	440105	2.075
900-01030C04005	647	<b>1</b>	1	Yes	443847	6.85	900-02306C00755	648	<b>1</b>	1	Yes	440020	15.75
900-01053C00101	647	<b>10</b>	10	Yes	443755	0.3	900-02408C00101	648	<b>5</b>	5	Yes	439918	3.61
900-01053C00201	647	<b>10</b>	10	Yes	443748	0.57	900-02408C00505	648	<b>1</b>	1	Yes	439888	20.05
900-01053C03005	647	<b>1</b>	1	Yes	443687	9.55	900-02509C00021	648	<b>5</b>	5	Yes	206374	1.44
900-01103C00101	647	<b>10</b>	10	Yes	443526	0.4	900-02509C00505	648	<b>1</b>	1	Yes	439796	32.15
900-01103C00201	647	<b>10</b>	10	Yes	443496	0.76	900-02609C00021	648	<b>5</b>	5	Yes	206381	1.39
900-01103C00501	647	<b>2</b>	2	Yes	443458	2.125	900-02609C00505	648	<b>1</b>	1	Yes	439727	33.5

Item No	Page No	Min Qty	Case Qty	UPC Bar-Coded	UPC 6-Digit	Weight (lbs.)	Item No	Page No	Min Qty	Case Qty	UPC Bar-Coded	UPC 6-Digit	Weight (lbs.)
900-04258N00101	626	<b>10</b>	10	Yes	439659	3.055	901-03020W01001	653	<b>1</b>	1	Yes	437655	1.4
900-04258N00101	657	<b>10</b>	10	Yes	439659	3.055	901-03020W01005	618	<b>1</b>	1	Yes	437839	1.35
900-04258N00505	626	<b>1</b>	1	Yes	439635	16.6	901-03020W01005	653	<b>1</b>	1	Yes	437839	1.35
900-04258N00505	657	<b>1</b>	1	Yes	439635	16.6	901-03020W04005	618	<b>1</b>	1	Yes	437785	4.1
900-04338N00021	626	<b>12</b>	12	Yes	439581	0.7917	901-03020W04005	653	<b>1</b>	1	Yes	437785	4.1
900-04338N00021	657	<b>12</b>	12	Yes	439581	0.7917	901-03053W00101	653	<b>5</b>	5	Yes	437587	0.27
900-04338N00101	626	<b>5</b>	5	Yes	439550	0.5	901-03053W03005	653	<b>1</b>	1	Yes	437518	6.5
900-04338N00101	657	<b>5</b>	5	Yes	439550	0.5	901-03103W00251	653	<b>10</b>	10	Yes	437433	0.745
900-06103Y00101	658	<b>5</b>	5	Yes	439468	0.3	901-03103W01005	653	<b>1</b>	1	Yes	437372	3
900-06103Y00505	658	<b>1</b>	1	Yes	439437	2.35	901-03103W03005	653	<b>1</b>	1	Yes	437327	9.1
900-07256G01505	657	<b>1</b>	1	Yes	439345	19.5	901-03163W00251	653	<b>5</b>	5	Yes	437204	1.07
900-12256N00101	625	<b>5</b>	5	Yes	438980	2.22	901-03163W01005	653	<b>1</b>	1	Yes	437136	3.97
900-12256N00101	657	<b>5</b>	5	Yes	438980	2.22	901-03163W02005	653	<b>1</b>	1	Yes	437082	8.7
900-12306N00101	657	<b>5</b>	5	Yes	438928	2.48	901-10	741	<b>10</b>	100	No	507624	0.0415
900-14010R00051	661	<b>10</b>	10	Yes	206596	0.12	901-12	741	<b>10</b>	100	No	507631	0.044
900-14010R01005	661	<b>1</b>	1	Yes	438782	1.85	901-16	741	<b>10</b>	100	No	507648	0.048
900-14018R00051	661	<b>10</b>	10	Yes	206633	0.09	901-20	741	<b>10</b>	100	No	507655	0.0465
900-14018R01004	661	<b>1</b>	1	Yes	438775	2.1	901-24	741	<b>10</b>	100	No	507662	0.052
900-14023R00101	661	<b>5</b>	5	Yes	205704	0.2	901-28	741	<b>10</b>	100	No	507679	0.0709
900-15106N00051	661	<b>5</b>	5	Yes	438690	0.45	901-32	741	<b>10</b>	100	No	507686	0.058
900-15106N01005	661	<b>1</b>	1	Yes	438652	9.35	902	626	<b>50</b>	50	Yes	507693	0.196
900-15157N00051	661	<b>1</b>	10	Yes	206695	0.5	90201	626	<b>1</b>	100	No	450500	0.2
900-15166N00051	661	<b>1</b>	10	Yes	206589	0.555	902-125001	751	<b>2</b>	24	Yes	436931	0.06
900-16200W01004	658	<b>1</b>	1	Yes	438591	18.5	902-126001	751	<b>2</b>	24	Yes	436924	0.07
900-16300W00021	658	<b>1</b>	5	Yes	206602	0.44	903-120201	721	<b>5</b>	60	Yes	436887	0.0258
900-16300W00101	658	<b>1</b>	1	Yes	438584	2.1	903-120501	721	<b>5</b>	60	Yes	436870	0.02
900-16300W01004	658	<b>1</b>	1	Yes	438577	22.95	903-121001	721	<b>5</b>	60	Yes	436863	0.05
900-16400W00021	658	<b>1</b>	5	Yes	206718	0.59	903-121501	721	<b>5</b>	60	Yes	436856	0.04
900-16400W00101	658	<b>1</b>	1	Yes	438560	3.95	903-121601	721	<b>5</b>	60	Yes	436849	0.04
900-16400W00504	658	<b>1</b>	1	Yes	438553	17.2	903-122001	721	<b>5</b>	60	Yes	436832	0.06
900-16500W00021	658	<b>1</b>	5	Yes	206879	0.79	903-122501	721	<b>5</b>	40	Yes	436825	0.05
900-16500W00101	658	<b>1</b>	1	Yes	438539	5.35	903-123301	721	<b>5</b>	60	Yes	735089	0.172
900-16500W00504	658	<b>1</b>	1	Yes	438522	26.65	903-400201	721	<b>5</b>	60	Yes	436757	0.0392
900-16600W00021	658	<b>1</b>	5	Yes	206886	0.9	903-401001	721	<b>5</b>	60	Yes	436733	0.05
900-16600W00101	658	<b>1</b>	1	Yes	438508	5.75	903-401601	721	<b>5</b>	60	Yes	436726	0.07
900-16600W00504	658	<b>1</b>	1	Yes	438492	24.5	903-402001	721	<b>5</b>	60	Yes	436719	0.1
900-16700W00021	658	<b>1</b>	5	Yes	206909	1.32	903-403001	721	<b>5</b>	60	Yes	436702	0.1708
900-16700W00101	658	<b>1</b>	1	Yes	206930	8.95	903-404001	721	<b>5</b>	60	Yes	436696	0.042
900-16700W00254	658	<b>1</b>	1	Yes	438478	20.5	903-41021001	721	<b>5</b>	60	Yes	436689	0.04
900-18300W00061	658	<b>3</b>	3	Yes	438423	0.35	903-41050201	721	<b>5</b>	60	Yes	436672	0.05
900-18430W00061	658	<b>3</b>	3	Yes	438393	0.5	903-41051001	721	<b>5</b>	60	Yes	436665	0.05
900-19600B00251	658	<b>5</b>	5	Yes	438300	2.04	903-41100201	721	<b>5</b>	60	Yes	436658	0.04
900-19600B00501	658	<b>5</b>	5	Yes	438294	4	903-41101601	721	<b>5</b>	60	Yes	436641	0.05
900-19700B00251	658	<b>5</b>	5	Yes	438225	2.62	903-41102001	721	<b>5</b>	60	Yes	436634	0.0875
900-19700B00501	658	<b>5</b>	5	Yes	438195	4.13	903-41150201	721	<b>5</b>	60	Yes	436627	0.0375
901-03020W00251	618	<b>10</b>	10	Yes	437921	0.325	903-41151001	721	<b>5</b>	60	Yes	436610	0.07
901-03020W00251	653	<b>10</b>	10	Yes	437921	0.325	903-41151601	721	<b>5</b>	60	Yes	436603	0.0833
901-03020W00501	618	<b>5</b>	5	Yes	437662	0.62	903-41161001	721	<b>5</b>	60	Yes	436573	0.03
901-03020W00501	653	<b>5</b>	5	Yes	437662	0.62	903-41162001	721	<b>5</b>	60	Yes	436566	0.0933
901-03020W01001	618	<b>1</b>	1	Yes	437655	1.4	903-41201001	721	<b>5</b>	60	Yes	436559	0.07

Supply

Drainage

Support

Specialties

Appendix

# Numerical Index

Supply

Drainage

Support

Specialties

Appendix

Item No	Page No	Min Qty	Case Qty	UPC Bar-Coded	UPC 6-Digit	Weight (lbs.)	Item No	Page No	Min Qty	Case Qty	UPC Bar-Coded	UPC 6-Digit	Weight (lbs.)
903-41201601	721	5	60	Yes	436542	0.11	904-22201601	726	5	60	Yes	435934	0.03
903-41203001	721	5	60	Yes	436535	0.165	904-25101	725	5	60	Yes	435903	0.0267
903-41251601	721	5	60	Yes	436511	0.095	904-251601	725	5	60	Yes	435880	0.02
903-41252001	721	5	60	Yes	436504	0.12	904-252001	725	5	60	Yes	435866	0.02
903-41253001	721	5	60	Yes	436498	0.15	904-252501	725	5	60	Yes	435842	0.02
903-41302001	721	5	60	Yes	436481	0.11	904-253001	725	5	60	Yes	435835	0.03
903-441001	722	5	60	Yes	436320	0.0558	904-254001	725	5	60	Yes	435828	0.0767
903-441601	722	5	60	Yes	436313	0.07	904-271001	727	5	60	Yes	435798	0.02
903-442001	722	5	60	Yes	436306	0.09	904-271601	727	5	60	Yes	435781	0.03
903-45021001	722	5	40	Yes	436467	0.0538	904-272001	727	5	60	Yes	435774	0.03
903-45051001	722	5	60	Yes	436344	0.0658	904-273001	727	5	60	Yes	435767	0.05
903-45100201	722	5	60	Yes	436443	0.0533	904-28101601	727	5	60	Yes	435736	0.02
903-45151001	722	5	60	Yes	436429	0.1192	904-28161001	727	5	60	Yes	435712	0.03
903-45161001	722	5	60	Yes	436405	0.0683	904-28162001	727	5	60	Yes	435705	0.04
903-45162001	722	5	60	Yes	436399	0.0875	904-28163001	727	5	60	Yes	435699	0.04
903-45201601	722	5	60	Yes	436375	0.0967	904-28201001	727	5	60	Yes	435682	0.03
903-461601	722	5	60	Yes	436368	0.0842	904-28201601	727	5	60	Yes	435675	0.03
903-L99531	722	1	5	No	450616	0.62	904-28203001	727	5	60	Yes	435668	0.0525
903-L99560	722	1	5	No	450623	0.67	904-28252001	727	5	60	Yes	435637	0.03
903-L99625	722	1	5	No	450647	0.76	904-28253001	727	5	60	Yes	435620	0.04
903-L99656	722	1	5	No	450654	0.79	904-28302001	727	5	60	Yes	435613	0.05
903-L99690	722	1	5	No	450661	0.83	904-28304001	727	5	60	Yes	435606	0.06
903-L99812	722	1	4	No	450685	0.975	904-28403001	727	5	60	Yes	435583	0.07
904-120201	725	5	60	Yes	436290	0.02	904-401001	726	5	60	Yes	435569	0.02
904-120501	725	5	60	Yes	436283	0.02	904-401601	726	5	60	Yes	435552	0.02
904-121001	725	5	60	Yes	436276	0.02	904-402001	726	5	60	Yes	435545	0.04
904-121501	725	5	60	Yes	436269	0.02	904-403001	726	5	60	Yes	435538	0.03
904-121601	725	5	60	Yes	436252	0.02	904-404001	726	5	60	Yes	435521	0.05
904-122001	725	5	60	Yes	436245	0.04	904-405001	726	4	4	Yes	435514	0.1375
904-122501	725	5	60	Yes	436238	0.02	904-407001	726	1	4	Yes	469021	0.275
904-123001	725	5	60	Yes	436221	0.03	904-41050201	726	5	60	Yes	435491	0.0258
904-124001	725	5	60	Yes	436214	0.05	904-41051001	726	5	60	Yes	435484	0.0283
904-125001	725	2	24	Yes	436207	0.1	904-41100101	726	5	60	Yes	435477	0.02
904-126001	725	2	24	Yes	436184	0.1521	904-41101601	726	5	60	Yes	435460	0.02
904-127001	725	1	4	Yes	436160	0.425	904-41102001	726	5	60	Yes	435453	0.05
904-13100501	725	5	60	Yes	436153	0.02	904-41151001	726	5	60	Yes	435439	0.0308
904-13161001	725	5	60	Yes	436146	0.02	904-41160201	726	5	60	Yes	435422	0.02
904-13201601	725	5	60	Yes	436122	0.02	904-41161001	726	5	60	Yes	435415	0.02
904-13252001	725	5	60	Yes	436108	0.03	904-41162001	726	5	60	Yes	435408	0.035
904-200201	725	5	60	Yes	436092	0.05	904-41163001	726	5	60	Yes	435392	0.03
904-200501	725	5	60	Yes	436085	0.0233	904-41201001	726	5	60	Yes	435385	0.02
904-201001	725	5	60	Yes	436078	0.02	904-41201601	726	5	60	Yes	435378	0.04
904-201601	725	5	60	Yes	436054	0.04	904-41203001	726	5	60	Yes	435361	0.04
904-202000	725	1	1	No	436047	9.1	904-41251601	726	5	60	Yes	435330	0.02
904-202001	725	5	60	Yes	436030	0.0417	904-41252001	726	5	60	Yes	435323	0.03
904-202501	725	5	60	Yes	436016	0.04	904-41253001	726	5	60	Yes	435316	0.03
904-203001	725	5	60	Yes	436009	0.08	904-41302001	726	5	60	Yes	435309	0.03
904-204001	725	5	60	Yes	435996	0.07	904-41304001	726	5	60	Yes	435293	0.04
904-22161001	726	5	60	Yes	435958	0.0333	904-41403001	726	5	60	Yes	435279	0.04
904-22162001	726	5	60	Yes	435941	0.02	904-457001	727	1	4	Yes	435231	0.3375



Item No	Page No	Min Qty	Case Qty	UPC Bar-Coded	UPC 6-Digit	Weight (lbs.)	Item No	Page No	Min Qty	Case Qty	UPC Bar-Coded	UPC 6-Digit	Weight (lbs.)
905	625	<b>1</b>	1	No	507709	10.5	907-081000	678	<b>1</b>	5	Yes	434517	1.466
905	657	<b>1</b>	1	No	507709	10.5	907-081003	678	<b>10</b>	120	Yes	434500	0.02
905-050402	741	<b>5</b>	60	No	435224	0.0458	907-081025	678	<b>5</b>	20	Yes	434494	0.41
905-050602	741	<b>5</b>	60	No	435217	0.0958	907-081603	678	<b>5</b>	40	Yes	434487	0.09
905-050802	741	<b>5</b>	60	No	435200	0.0427	907-081625	678	<b>5</b>	60	Yes	434470	0.575
905-051202	741	<b>5</b>	60	No	435194	0.04	907-082003	678	<b>5</b>	40	Yes	434463	0.13
905-052402	741	<b>5</b>	60	No	435170	0.0617	907-082025	678	<b>5</b>	30	Yes	434456	0.905
905-053602	741	<b>5</b>	60	No	435163	0.0717	907-120201	671	<b>5</b>	60	Yes	434432	0.0633
905-055602	741	<b>10</b>	60	No	435156	0.05	907-120205	671	<b>1</b>	60	Yes	455703	0.2225
905-057202	741	<b>10</b>	60	No	435149	0.1083	907-120210	671	<b>5</b>	20	Yes	434425	0.44
905-058802	741	<b>10</b>	60	No	435132	0.115	907-121001	671	<b>5</b>	60	Yes	434418	0.085
905-160802	741	<b>10</b>	120	No	435095	0.0496	907-121005	671	<b>5</b>	60	Yes	433435	0.3217
905-163602	741	<b>1</b>	10	No	435026	0.13	907-121601	671	<b>5</b>	60	Yes	434401	0.1125
905-PK	625	<b>50</b>	50	No	500564	0.2146	907-121605	671	<b>5</b>	60	Yes	455727	0.248
905-PK	657	<b>50</b>	50	No	500564	0.2146	907-122001	671	<b>5</b>	60	Yes	434388	0.15
906	625	<b>1</b>	1	No	507716	18	907-122005	671	<b>1</b>	50	Yes	455734	0.688
906	657	<b>1</b>	1	No	507716	18	907-123001	671	<b>2</b>	24	Yes	434371	0.3333
906-0402	741	<b>5</b>	60	Yes	435002	0.02	907-13100201	671	<b>5</b>	60	Yes	207098	0.0775
906-0502	741	<b>5</b>	60	Yes	434999	0.01	907-1920201601	672	<b>5</b>	60	Yes	434333	0.3075
906-0602	741	<b>5</b>	60	Yes	434975	0.02	907-1930302001	672	<b>2</b>	24	Yes	434326	0.5396
906-0802	741	<b>5</b>	60	Yes	434968	0.02	907-201001	671	<b>5</b>	60	Yes	434319	0.15
906-1002	741	<b>5</b>	40	Yes	434944	0.02	907-2120200201	613	<b>5</b>	60	Yes	434272	0.1983
906-1202	741	<b>10</b>	120	Yes	434937	0.0271	907-24101001	672	<b>5</b>	60	Yes	206145	0.175
906-1402	741	<b>10</b>	120	Yes	434920	0.0375	907-24202001	672	<b>5</b>	60	Yes	206299	0.3867
906-PK	625	<b>50</b>	50	No	200266	0.347	907-251601	672	<b>5</b>	60	Yes	434241	0.1792
906-PK	657	<b>50</b>	50	No	200266	0.347	907-27101601	676	<b>5</b>	60	Yes	434234	0.13
907-010103	677	<b>5</b>	60	Yes	434906	0.0333	907-27101605	676	<b>5</b>	20	Yes	434227	0.585
907-010203	677	<b>10</b>	120	Yes	434890	0.01	907-32102010	677	<b>1</b>	10	No	740519	1.597
907-010503	677	<b>5</b>	20	Yes	434876	0.02	907-40021001	673	<b>5</b>	60	Yes	434173	0.0742
907-011003	677	<b>10</b>	120	Yes	434869	0.03	907-40101001	673	<b>5</b>	60	Yes	434166	0.07
907-011603	677	<b>5</b>	60	Yes	434845	0.04	907-40102005	673	<b>1</b>	60	Yes	469175	0.4358
907-011625	677	<b>5</b>	60	Yes	434838	0.13	907-4020200505	673	<b>5</b>	60	Yes	434128	0.5892
907-012003	677	<b>5</b>	60	Yes	434814	0.05	907-40303001	673	<b>2</b>	24	Yes	434111	0.25
907-012503	677	<b>5</b>	60	Yes	434807	0.0567	907-41102001	673	<b>5</b>	60	Yes	434159	0.11
907-013003	677	<b>5</b>	60	Yes	434784	0.07	907-41201005	673	<b>5</b>	20	Yes	457004	0.52
907-020203	678	<b>10</b>	120	Yes	434753	0.0142	907-41202001	673	<b>5</b>	60	Yes	434135	0.12
907-020210	678	<b>1</b>	480	Yes	434746	0.0074	907-43102001	676	<b>5</b>	60	Yes	434104	0.0708
907-020225	678	<b>1</b>	60	Yes	434739	0.0158	907-44021001	675	<b>5</b>	60	Yes	434098	0.0683
907-021000	678	<b>1</b>	50	Yes	434715	0.0308	907-44101601	675	<b>5</b>	60	Yes	434081	0.0708
907-021003	678	<b>10</b>	120	Yes	434708	0.02	907-4410200505	675	<b>5</b>	60	Yes	434067	0.4275
907-021025	678	<b>5</b>	60	Yes	434692	0.0325	907-44162001	675	<b>5</b>	60	Yes	434050	0.1017
907-022003	678	<b>5</b>	20	Yes	434647	0.02	907-45102001	675	<b>5</b>	60	Yes	434074	0.09
907-022010	678	<b>1</b>	150	Yes	434630	0.015	907-45202001	675	<b>5</b>	60	Yes	434043	0.12
907-050202	677	<b>10</b>	120	Yes	434623	0.02	907-47100200	673	<b>1</b>	10	No	434036	3.95
907-050502	677	<b>5</b>	60	Yes	434616	0.03	907-47100201	673	<b>5</b>	60	Yes	430861	0.25
907-051002	677	<b>5</b>	60	Yes	434609	0.03	907-47101601	673	<b>5</b>	20	Yes	430847	0.105
907-051602	677	<b>5</b>	60	Yes	434586	0.02	907-47151001	673	<b>5</b>	60	Yes	430830	0.0783
907-080103	678	<b>5</b>	60	Yes	434555	0.04	907-47161001	673	<b>5</b>	40	Yes	430823	0.06
907-080203	678	<b>10</b>	120	Yes	434548	0.04	907-480201	676	<b>5</b>	60	Yes	434012	0.055
907-080503	678	<b>5</b>	60	Yes	434524	0.065	907-481001	676	<b>5</b>	40	Yes	434005	0.09

Supply

Drainage

Support

Specialties

Appendix

# Numerical Index

Supply

Drainage

Support

Specialties

Appendix

Item No	Page No	Min Qty	Case Qty	UPC Bar-Coded	UPC 6-Digit	Weight (lbs.)	Item No	Page No	Min Qty	Case Qty	UPC Bar-Coded	UPC 6-Digit	Weight (lbs.)
907-490201	678	<b>5</b>	60	Yes	433992	0.03	909-120101	671	<b>5</b>	60	Yes	433459	0.06
907-490501	678	<b>5</b>	60	Yes	433985	0.0392	909-120201	671	<b>10</b>	120	Yes	433442	0.05
907-491001	678	<b>5</b>	60	Yes	433954	0.05	909-120501	671	<b>5</b>	60	Yes	433428	0.08
907-491010	678	<b>5</b>	60	Yes	433947	0.2042	909-121001	671	<b>10</b>	60	Yes	433411	0.0772
907-491601	678	<b>5</b>	40	Yes	433930	0.04	909-121601	671	<b>5</b>	60	Yes	433404	0.11
907-492001	678	<b>5</b>	40	Yes	433923	0.04	909-122001	671	<b>5</b>	60	Yes	433398	0.1
907-541001	672	<b>5</b>	60	Yes	430854	0.16	909-123001	671	<b>2</b>	24	Yes	433374	0.3
907-58101001	674	<b>5</b>	60	Yes	503459	0.0592	909-13050201	671	<b>5</b>	40	Yes	433350	0.07
907-58161601	674	<b>5</b>	60	Yes	503466	0.0725	909-13100201	671	<b>5</b>	60	Yes	434364	0.06
907-58202001	674	<b>5</b>	60	Yes	503473	0.12	909-13160201	671	<b>5</b>	20	Yes	433343	0.13
907-981001	613	<b>5</b>	60	Yes	502933	0.1542	909-13161001	671	<b>5</b>	60	Yes	433336	0.11
907-L990201	679	10	120	Yes	206169	0.0271	909-13161060	671	<b>5</b>	60	Yes	433329	0.4492
908-061002	678	<b>5</b>	60	Yes	433909	0.06	909-13201001	671	<b>5</b>	60	Yes	433312	0.15
908-061602	678	<b>5</b>	20	Yes	433886	0.07	909-13201601	671	<b>5</b>	60	Yes	433305	0.15
908-070202	678	<b>5</b>	60	Yes	433879	0.0483	909-13302001	671	<b>2</b>	24	Yes	433282	0.2917
908-12020201	683	<b>5</b>	60	Yes	433848	0.02	909-14100201	673	<b>5</b>	60	Yes	433275	0.0775
908-12101001	683	<b>5</b>	60	Yes	433831	0.055	909-183001	672	<b>2</b>	24	Yes	433244	0.8396
908-12161601	683	<b>5</b>	60	Yes	433824	0.06	909-200201	672	<b>5</b>	60	Yes	433213	0.08
908-13100201	683	<b>5</b>	60	Yes	433817	0.03	909-201001	672	<b>5</b>	120	Yes	433206	0.15
908-13161001	683	<b>5</b>	60	Yes	433800	0.05	909-201601	672	<b>5</b>	40	Yes	433190	0.2
908-2002020201	683	<b>5</b>	60	Yes	433794	0.03	909-202001	672	<b>5</b>	60	Yes	433251	0.3
908-2010101001	683	<b>5</b>	60	Yes	433787	0.06	909-21100201	672	<b>5</b>	60	Yes	433237	0.15
908-2210101001	683	<b>5</b>	60	Yes	433770	0.05	909-250201	672	<b>5</b>	40	Yes	433169	0.04
908-25020201	683	<b>5</b>	60	Yes	433763	0.02	909-251001	672	<b>5</b>	40	Yes	433152	0.05
908-25101001	683	<b>5</b>	60	Yes	433756	0.0583	909-251601	672	<b>5</b>	20	Yes	433145	0.15
908-27020201	684	<b>5</b>	60	Yes	433749	0.02	909-252001	672	<b>5</b>	60	Yes	433138	0.25
908-27021001	684	<b>5</b>	60	Yes	433732	0.03	909-263001	672	<b>2</b>	24	Yes	433121	0.6688
908-27021601	684	<b>5</b>	60	Yes	433725	0.03	909-29021001	676	<b>5</b>	40	Yes	433077	0.09
908-27101001	684	<b>5</b>	60	Yes	433718	0.03	909-29101601	676	<b>5</b>	60	Yes	433060	0.05
908-40020201	683	<b>5</b>	60	Yes	433701	0.02	909-29162001	676	<b>5</b>	20	Yes	433053	0.1
908-40021001	683	<b>5</b>	60	Yes	433695	0.02	909-30020201	676	<b>5</b>	40	Yes	433046	0.07
908-40021601	683	<b>5</b>	60	Yes	433688	0.02	909-30101001	676	<b>5</b>	40	Yes	433039	0.25
908-40100201	683	<b>5</b>	60	Yes	433671	0.0425	909-30102001	676	<b>5</b>	40	Yes	433022	0.05
908-40101001	683	<b>5</b>	60	Yes	433664	0.03	909-30161601	676	<b>5</b>	40	Yes	433015	0.15
908-40101601	683	<b>5</b>	60	Yes	433657	0.03	909-30201601	677	<b>5</b>	20	Yes	433008	0.175
908-40161601	683	<b>5</b>	60	Yes	433633	0.04	909-30202001	677	<b>5</b>	40	Yes	432995	0.15
909-030200	679	<b>1</b>	50	Yes	433619	0.224	909-32102001	677	<b>5</b>	60	Yes	432988	0.1483
909-030203	679	<b>5</b>	60	Yes	433602	0.025	909-32202001	677	<b>5</b>	60	Yes	432971	0.2542
909-031000	679	<b>1</b>	10	Yes	433589	0.126	909-40000201	674	<b>5</b>	60	Yes	432964	0.0583
909-031003	679	<b>5</b>	60	Yes	433572	0.0358	909-40010201	674	<b>5</b>	60	Yes	432957	0.0583
909-031603	679	<b>5</b>	60	Yes	433565	0.0392	909-40021001	673	<b>5</b>	60	Yes	432933	0.07
909-032003	679	<b>5</b>	60	Yes	433558	0.0425	909-40101601	673	<b>5</b>	60	Yes	432872	0.1
909-032010	679	<b>1</b>	10	Yes	433541	0.01	909-40162001	674	<b>5</b>	60	Yes	432834	0.1
909-070201	679	<b>10</b>	120	Yes	433534	0.03	909-40201601	674	<b>5</b>	20	Yes	432827	0.15
909-070501	679	<b>5</b>	60	Yes	433510	0.04	909-40203001	674	<b>5</b>	60	Yes	432803	0.1
909-071001	679	<b>10</b>	120	Yes	433503	0.04	909-40253001	674	<b>5</b>	60	Yes	432797	0.25
909-071601	679	<b>5</b>	20	Yes	433497	0.06	909-40303001	674	<b>2</b>	24	Yes	432780	0.2
909-072001	679	<b>5</b>	40	Yes	433480	0.07	909-41020201	673	<b>5</b>	60	Yes	432940	0.05
909-073001	679	<b>5</b>	60	Yes	433473	0.1125	909-41021601	673	<b>5</b>	60	Yes	432926	0.05
909-120001	671	<b>5</b>	60	Yes	433466	0.05	909-41022001	673	<b>5</b>	60	Yes	432919	0.1158

Item No	Page No	Min Qty	Case Qty	UPC Bar-Coded	UPC 6-Digit	Weight (lbs.)	Item No	Page No	Min Qty	Case Qty	UPC Bar-Coded	UPC 6-Digit	Weight (lbs.)
909-41051001	673	5	20	Yes	432902	0.07	921-7W	621	20	100	No	407290	0.0349
909-41101001	673	5	60	Yes	432889	0.05	921-7WPK2	621	10	10	Yes	407283	0.0511
909-41102001	673	10	120	Yes	432865	0.05	922-5W	621	25	25	No	507983	0.1038
909-41103001	673	5	20	Yes	432858	0.15	922-5WPK2	621	10	10	Yes	407320	0.1091
909-41161601	674	5	60	Yes	432841	0.1	922-6W	621	25	25	No	507990	0.1028
909-41163001	674	5	60	Yes	432759	0.1367	922-6WPK2	621	10	10	Yes	407344	0.1081
909-41202001	674	5	60	Yes	432810	0.1283	923-1036C00	622	12	120	Yes	455925	0.03
909-41302001	674	2	24	Yes	432193	0.2667	923-1612C01	623	12	12	Yes	409041	0.0542
909-41303007	674	5	30	Yes	431707	0.4883	923-1613C01	623	12	12	Yes	709677	0.0625
909-43102001	676	5	40	Yes	431158	0.05	923-1614C01	623	12	120	Yes	709684	0.05
909-44021001	675	5	60	Yes	430991	0.05	923-1615C01	623	12	12	Yes	502964	0.0792
909-44021601	675	5	20	Yes	430984	0.09	923-1616C01	623	12	12	Yes	502971	0.075
909-44022001	675	5	40	Yes	430977	0.05	923-1622C01	624	12	12	Yes	409089	0.0542
909-44101601	675	5	60	Yes	430946	0.05	923-1623C01	624	12	12	Yes	409164	0.0542
909-44161601	675	5	20	Yes	430915	0.1	923-1624C01	624	12	12	Yes	708991	0.075
909-44162001	675	5	60	Yes	430908	0.1	923-1625C01	624	12	12	Yes	455796	0.0708
909-44203001	675	5	20	Yes	430885	0.17	923-1626C01	624	12	12	Yes	409263	0.0625
909-44303001	675	2	24	Yes	430878	0.2521	923-1627C01	624	12	12	Yes	709004	0.0917
909-45020201	675	5	60	Yes	431004	0.0383	923-2321C00	623	25	100	Yes	455802	0.045
909-45022001	675	5	40	Yes	430977	0.05	923-2322C00	623	25	100	Yes	455819	0.0495
909-45051001	675	5	20	Yes	430960	0.07	923-2326C00	622	5	100	Yes	455826	0.0815
909-45101001	675	5	40	Yes	430953	0.07	923-2335C00	623	5	100	Yes	455833	0.1
909-45102001	675	10	120	Yes	430939	0.05	923-2336C00	623	5	100	Yes	502544	0.0885
909-45202001	675	5	60	Yes	430892	0.1258	923-2435C00	623	25	25	Yes	455857	0.062
909-991001	613	5	60	Yes	434302	0.15	923-2436C00	623	25	25	Yes	455864	0.052
909-99100201	613	5	60	Yes	434296	0.15	923-2521C04	623	1	200	Yes	455871	0.12
910-2	622	25	250	Yes	408068	0.031	923-2522C04	623	1	200	Yes	455888	0.098
910-3	622	25	250	Yes	408143	0.0302	923-2525C04	623	1	200	Yes	455895	0.28
911-1	622	25	250	Yes	709721	0.03	923-2526C04	623	1	200	Yes	457554	0.222
911-2	622	25	250	Yes	408105	0.0298	923-2527C04	623	1	200	Yes	455901	0.232
911-3	622	25	250	Yes	408181	0.022	923-2536C04	623	1	200	Yes	455918	0.166
911-4	622	25	250	Yes	408235	0.0284	926-2	621	12	120	Yes	430069	0.0157
911-6	622	25	250	Yes	408273	0.0266	926-2W	621	12	120	Yes	508010	0.0145
911-6D	622	25	250	Yes	507785	0.06	926-3	621	12	120	Yes	430144	0.0279
911-7	622	25	250	Yes	408297	0.064	926-3W	621	12	120	Yes	508034	0.0165
920-1W	621	50	500	No	407030	0.0116	926-4	621	12	120	Yes	430212	0.025
920-2W	621	25	250	No	407061	0.0156	926-4W	621	12	120	Yes	508058	0.0321
920-2WPK2	621	10	10	Yes	407047	0.0463	927-2	622	12	120	Yes	495426	0.0283
920-3W	621	25	250	No	407146	0.0154	927-2W	622	12	120	Yes	508072	0.025
920-3WPK2	621	10	10	Yes	407122	0.0459	927-3	622	12	120	Yes	430182	0.025
920-4W	621	20	100	No	407214	0.0143	927-3W	622	12	120	Yes	508096	0.0228
920-4WPK2	621	1	1	Yes	407207	0.1014	927-4	622	12	120	Yes	430236	0.0279
921-2W	621	50	500	No	407108	0.0115	927-4W	622	12	120	Yes	508119	0.023
921-2WPK2	621	10	10	Yes	407085	0.0483	927-5	622	12	120	Yes	709356	0.0438
921-3W	621	50	500	No	407184	0.0111	927-6	622	12	120	Yes	430274	0.038
921-3WPK2	621	10	10	Yes	407160	0.0488	927-6W	622	12	120	Yes	508133	0.033
921-4W	621	20	100	No	407238	0.0429	927-7	622	12	120	Yes	430298	0.0446
921-4WPK2	621	10	10	Yes	407221	0.1293	927-7W	622	12	120	Yes	508157	0.041
921-6W	621	20	100	No	407276	0.0379	927-8W	622	12	120	Yes	508164	0.0452
921-6WPK2	621	10	10	Yes	407269	0.0541	928-12	640	50	500	No	508171	0.0067

Supply

Drainage

Support

Specialties

Appendix

# Numerical Index

Supply

Drainage

Support

Specialties

Appendix

Item No	Page No	Min Qty	Case Qty	UPC Bar-Coded	UPC 6-Digit	Weight (lbs.)	Item No	Page No	Min Qty	Case Qty	UPC Bar-Coded	UPC 6-Digit	Weight (lbs.)
928-2	640	<b>50</b>	500	No	508201	0.0063	930-273001	695	<b>5</b>	60	Yes	430090	0.35
929-01302001	102	<b>5</b>	20	Yes	430786	0.45	930-380201	695	<b>5</b>	60	Yes	429988	0.0733
929-01303001	102	<b>5</b>	60	Yes	430779	0.45	930-381005	695	<b>5</b>	60	Yes	429971	0.1133
930-120201	694	<b>5</b>	60	Yes	429308	0.05	930-46101001	675	<b>5</b>	60	Yes	722324	-
930-121001	694	<b>5</b>	60	Yes	429292	0.043	930-490201	695	<b>5</b>	40	Yes	429933	0.03
930-121601	694	<b>5</b>	60	Yes	429285	0.057	930-491001	695	<b>5</b>	60	Yes	429919	0.04
930-122001	694	<b>5</b>	60	Yes	430724	0.1417	930-491601	695	<b>5</b>	60	Yes	429896	0.05
930-122010	694	<b>1</b>	30	Yes	430717	0.9317	930-491610	695	<b>1</b>	60	Yes	429889	0.4808
930-123001	694	<b>5</b>	60	Yes	470454	0.1483	930-492001	695	<b>5</b>	60	Yes	429872	0.05
930-13100201	694	<b>5</b>	60	Yes	429186	0.06	930-492010	695	<b>1</b>	10	Yes	429865	0.632
930-13160201	694	<b>5</b>	20	Yes	430694	0.06	930-493001	695	<b>5</b>	20	Yes	429858	0.1
930-13161001	694	<b>5</b>	60	Yes	430687	0.05	930-493010	695	<b>1</b>	25	Yes	429841	1.274
930-13200201	694	<b>5</b>	20	Yes	430663	0.125	930-500201	697	<b>5</b>	60	Yes	429834	0.05
930-13201001	694	<b>5</b>	60	Yes	430656	0.05	930-501001	697	<b>5</b>	60	Yes	429810	0.04
930-13201601	694	<b>5</b>	60	Yes	430649	0.1	930-501010	697	<b>1</b>	150	Yes	429803	0.2603
930-13302001	694	<b>5</b>	60	Yes	430618	0.16	930-501601	697	<b>5</b>	60	Yes	429797	0.05
930-15100201	696	<b>5</b>	60	Yes	430595	0.03	930-502001	697	<b>5</b>	60	Yes	429766	0.09
930-15100210	696	<b>1</b>	150	Yes	430588	0.2327	930-502010	697	<b>1</b>	45	Yes	429759	0.7522
930-15160201	696	<b>5</b>	40	Yes	430571	0.06	930-503001	697	<b>5</b>	60	Yes	470492	0.1525
930-15161001	696	<b>5</b>	60	Yes	430557	0.05	930-504001	697	<b>2</b>	24	Yes	429742	0.2604
930-15161010	696	<b>1</b>	100	Yes	430540	0.3205	930-506001	697	<b>2</b>	24	Yes	429735	0.5229
930-15200201	696	<b>5</b>	60	Yes	430533	0.1	930-510201	697	<b>5</b>	60	Yes	429728	0.0367
930-15201001	696	<b>5</b>	60	Yes	430526	0.05	930-511001	697	<b>5</b>	60	Yes	429711	0.0492
930-15201601	696	<b>5</b>	60	Yes	430519	0.05	930-511601	697	<b>5</b>	60	Yes	429698	0.0758
930-15201610	696	<b>1</b>	60	Yes	430502	0.5183	930-512001	697	<b>5</b>	60	Yes	429674	0.1
930-15301001	696	<b>5</b>	60	Yes	430496	0.2092	930-513001	697	<b>5</b>	60	Yes	429667	0.1475
930-15301601	696	<b>5</b>	60	Yes	430489	0.1692	930-521001	697	<b>5</b>	60	Yes	429650	0.0392
930-15302001	696	<b>5</b>	60	Yes	430472	0.1	930-522001	697	<b>5</b>	60	Yes	429643	0.0817
930-15403001	696	<b>2</b>	24	Yes	430458	0.25	930-530201	697	<b>5</b>	40	Yes	429636	0.03
930-16161001	696	<b>5</b>	60	Yes	430441	0.0342	930-541001	694	<b>5</b>	60	Yes	429612	0.3133
930-16302001	696	<b>5</b>	60	Yes	430410	0.0733	930-543001	694	<b>5</b>	60	Yes	429605	0.77
930-200201	694	<b>5</b>	20	Yes	455956	0.07	930-56100201	695	<b>5</b>	60	Yes	429582	0.0558
930-201001	694	<b>5</b>	60	Yes	456694	0.275	930-56161001	695	<b>5</b>	60	Yes	429544	0.0983
930-201601	694	<b>5</b>	60	Yes	502551	0.1383	930-56201601	695	<b>5</b>	60	Yes	429520	0.12
930-202001	694	<b>5</b>	60	Yes	502797	0.2767	930-610201	696	<b>5</b>	60	Yes	429506	0.04
930-203001	694	<b>5</b>	60	Yes	206565	0.4425	930-611001	696	<b>5</b>	60	Yes	429490	0.07
930-21161001	694	<b>5</b>	60	Yes	430403	0.2075	930-611601	696	<b>5</b>	60	Yes	429483	0.06
930-250201	695	<b>5</b>	20	Yes	430373	0.08	930-611610	696	<b>1</b>	60	Yes	429476	0.63
930-251001	695	<b>5</b>	60	Yes	430366	0.05	930-612001	696	<b>5</b>	60	Yes	429469	0.1
930-251601	695	<b>5</b>	40	Yes	430359	0.14	930-613001	696	<b>5</b>	60	Yes	429452	0.19
930-252001	695	<b>5</b>	60	Yes	430342	0.25	930-62201001	696	<b>5</b>	60	Yes	429391	0.0967
930-253001	695	<b>5</b>	40	Yes	206527	0.33	930-62201601	696	<b>5</b>	60	Yes	429377	0.0958
930-257001	695	<b>2</b>	24	Yes	430250	0.1562	930-62302001	696	<b>5</b>	60	Yes	429360	0.2117
930-270201	695	<b>5</b>	60	Yes	430243	0.04	930-641001	697	<b>5</b>	60	Yes	429346	0.0567
930-270210	695	<b>1</b>	80	Yes	430199	0.3644	930-642001	697	<b>5</b>	20	Yes	502759	0.49
930-271001	695	<b>5</b>	60	Yes	430175	0.09	930-643001	697	<b>5</b>	60	Yes	429315	0.14
930-271010	695	<b>1</b>	50	Yes	430151	0.79	931-122001	701	<b>5</b>	60	Yes	429278	0.05
930-271601	695	<b>5</b>	60	Yes	430137	0.1	931-123001	701	<b>5</b>	60	Yes	429247	0.1
930-271610	695	<b>1</b>	12	Yes	430113	1.2375	931-124001	701	<b>2</b>	24	Yes	429230	0.43
930-272001	695	<b>5</b>	60	Yes	430106	0.2217	931-126001	701	<b>2</b>	24	Yes	429209	0.9

Item No	Page No	Min Qty	Case Qty	UPC Bar-Coded	UPC 6-Digit	Weight (lbs.)	Item No	Page No	Min Qty	Case Qty	UPC Bar-Coded	UPC 6-Digit	Weight (lbs.)
931-127001	701	2	24	Yes	429193	1.5292	931-511001	704	5	60	Yes	456182	0.0775
931-13100201	701	5	60	Yes	430700	0.1	931-513001	704	5	60	Yes	456212	0.1692
931-13160201	701	5	20	Yes	429179	0.145	931-542001	701	5	60	Yes	456236	0.4842
931-13161001	701	5	60	Yes	429162	0.1358	931-544001	701	2	24	Yes	428844	0.9896
931-13200201	701	5	60	Yes	429155	0.1725	931-545001	701	2	10	Yes	456250	1.44
931-13403001	701	2	24	Yes	429100	0.3	931-546001	701	2	12	Yes	456267	1.9333
931-13503001	701	2	24	Yes	429094	0.6292	931-547001	701	2	12	Yes	206473	2.6875
931-13604001	701	2	24	Yes	429070	0.8146	931-56100201	702	5	60	Yes	456274	0.0883
931-13705001	701	2	24	Yes	429063	1.2396	931-56161001	702	5	60	Yes	456892	0.115
931-13706001	701	2	24	Yes	429056	1.2646	931-610201	703	5	60	Yes	456984	0.0617
931-15302001	703	5	60	Yes	428981	0.1758	931-611001	703	5	60	Yes	456304	0.0858
931-15503001	703	2	24	Yes	428967	0.55	931-640201	703	5	60	Yes	428837	0.0542
931-15605001	703	2	24	Yes	455932	0.5042	931-641001	703	5	60	Yes	428820	0.0658
931-15705001	703	2	16	Yes	455949	0.9625	931-641601	703	5	60	Yes	428813	0.0875
931-181601	701	5	60	Yes	456854	0.2408	933-122001	707	5	60	Yes	428769	0.04
931-200201	701	5	20	Yes	456946	0.135	933-15201001	708	5	60	Yes	428721	0.0308
931-202001	701	5	60	Yes	455963	0.3	933-15302001	708	5	60	Yes	428691	0.05
931-203001	701	5	60	Yes	455970	0.4	933-15604001	708	2	24	Yes	428646	0.1
931-204001	701	2	24	Yes	455987	0.75	933-252001	707	5	60	Yes	428608	0.07
931-250201	702	5	20	Yes	428936	0.1025	933-253001	707	5	60	Yes	428585	0.09
931-251001	702	5	60	Yes	428929	0.1283	933-254001	707	2	24	Yes	428561	0.18
931-251601	702	5	40	Yes	428912	0.1125	933-611001	708	5	60	Yes	428493	0.02
931-252001	702	5	60	Yes	456014	0.25	933-611601	708	5	60	Yes	428486	0.0333
931-253001	702	5	60	Yes	456021	0.3	933-612001	708	5	60	Yes	428479	0.03
931-254001	702	2	24	Yes	430335	0.57	933-614001	708	5	60	Yes	428455	0.05
931-25500	702	2	24	Yes	456755	1.0146	933-822001	707	5	60	Yes	428448	0.11
931-256001	702	2	12	Yes	456038	1.4833	933-823001	707	5	60	Yes	428431	0.1
931-270201	702	5	60	Yes	456830	0.0825	933-8320P01	707	5	60	Yes	428417	0.86
931-272001	702	5	60	Yes	456045	0.2567	933-833001	707	5	60	Yes	428400	0.1
931-273001	702	5	60	Yes	456052	0.3808	933-8330P01	707	5	60	Yes	428394	0.1
931-274001	702	2	24	Yes	428905	0.7271	933-842001	707	5	60	Yes	428387	0.11
931-275001	702	2	24	Yes	456809	1.0271	933-8420P01	707	5	60	Yes	428370	0.11
931-277001	702	2	24	Yes	456076	2.0833	933-843001	707	5	60	Yes	428363	0.1
931-371601	702	5	60	Yes	430014	0.1542	933-8430P01	707	5	60	Yes	428356	0.1
931-372001	702	5	60	Yes	430007	0.2483	933-845001	707	1	2	Yes	428349	0.575
931-373001	702	5	60	Yes	456090	0.3642	933-8450P01	707	2	24	Yes	428332	0.4688
931-382001	702	5	60	Yes	429957	0.235	933-8460P01	707	2	24	Yes	428325	0.7875
931-383001	702	5	60	Yes	429940	0.3183	933-8470P01	707	2	24	Yes	428318	0.7021
931-490201	703	5	40	Yes	428899	0.055	933-852001	707	1	5	Yes	428301	0.26
931-491001	703	5	60	Yes	428882	0.0775	933-853001	707	1	5	Yes	428295	0.23
931-491601	703	5	60	Yes	428875	0.1108	934-02001	711	5	60	Yes	428288	0.03
931-493001	703	5	60	Yes	456113	0.23	934-021.501	711	5	60	Yes	428271	0.04
931-494001	703	2	24	Yes	456120	0.28	934-02201	711	5	40	Yes	428257	0.05
931-497001	703	2	24	Yes	456724	1.1458	934-02401	711	5	20	Yes	428240	0.11
931-501010	703	5	60	Yes	456144	0.0633	934-10001	711	5	60	Yes	428202	0.06
931-503001	703	5	60	Yes	428851	0.15	934-101.501	711	5	60	Yes	428196	0.06
931-504001	703	5	20	Yes	456823	0.245	934-102.501	711	5	60	Yes	428189	0.1142
931-505001	703	2	24	Yes	456168	0.4229	934-10201	711	5	60	Yes	428172	0.09
931-507001	703	2	24	Yes	206466	0.7688	934-10301	711	5	60	Yes	428158	0.1
931-510201	704	5	60	Yes	456175	0.0592	934-10401	711	5	60	Yes	428141	0.19

Supply

Drainage

Support

Specialties

Appendix

# Numerical Index

Supply

Drainage

Support

Specialties

Appendix

Item No	Page No	Min Qty	Case Qty	UPC Bar-Coded	UPC 6-Digit	Weight (lbs.)	Item No	Page No	Min Qty	Case Qty	UPC Bar-Coded	UPC 6-Digit	Weight (lbs.)
934-10501	711	5	40	Yes	428127	0.1962	935-40301	712	2	24	Yes	427496	0.3979
934-16001	711	5	60	Yes	428103	0.0517	935-40601	712	2	24	Yes	427472	0.8729
934-161.501	711	5	60	Yes	428097	0.05	935-50301	712	2	24	Yes	427465	0.575
934-162.501	711	5	20	Yes	428080	0.15	935-70401	713	2	24	Yes	502704	1.3
934-16201	711	5	40	Yes	428073	0.11	936-16001	712	5	60	Yes	427403	0.0533
934-16301	711	5	20	Yes	428059	0.15	936-16201	712	5	60	Yes	427380	0.3492
934-16401	711	5	20	Yes	428042	0.24	936-16301	712	5	60	Yes	427366	0.1567
934-16601	711	5	60	Yes	428028	0.325	936-16401	712	5	60	Yes	427359	0.22
934-20001	711	5	60	Yes	428011	0.17	936-16501	712	5	60	Yes	427342	0.2792
934-201.501	711	5	60	Yes	428004	0.09	936-16601	712	5	60	Yes	427335	0.3292
934-202.501	711	5	60	Yes	427991	0.15	936-20001	712	5	60	Yes	427328	0.0725
934-20201	711	5	60	Yes	427984	0.1383	936-201.501	712	5	60	Yes	427311	0.095
934-203.501	711	5	60	Yes	427977	0.2342	936-20201	712	5	60	Yes	427304	0.1275
934-20301	711	5	60	Yes	427960	0.19	936-203.501	712	5	60	Yes	427298	0.225
934-204.501	711	5	60	Yes	427953	0.2933	936-20301	712	5	60	Yes	427281	0.1908
934-20401	711	5	60	Yes	427946	0.2	936-20401	712	5	60	Yes	427274	0.2617
934-205.501	711	5	60	Yes	427939	0.3683	936-20501	712	5	60	Yes	427267	0.33
934-20501	711	5	60	Yes	427922	0.34	937-1230201	731	5	60	Yes	204547	0.1658
934-20601	711	5	60	Yes	427915	0.35	937-123030101	731	5	60	Yes	427236	0.1175
934-30001	711	5	60	Yes	427908	0.12	937-2330101	732	5	20	Yes	427229	0.25
934-301.501	711	5	60	Yes	427892	0.1	937-4930100	732	5	60	Yes	427205	0.0617
934-302.501	711	5	60	Yes	427885	0.22	937-4930101	732	5	60	Yes	427199	0.07
934-30201	711	5	60	Yes	427878	0.1	937-65303001	732	5	60	Yes	427175	0.15
934-30301	711	5	60	Yes	427854	0.27	937-66302001	732	5	40	Yes	427168	0.16
934-30401	711	5	40	Yes	427830	0.3	937-66302501	732	5	20	Yes	427151	0.18
934-30501	711	5	60	Yes	427823	0.4283	937-6730101	731	5	60	Yes	427144	0.1683
934-30601	711	5	60	Yes	427816	0.4758	937-67303020101	731	5	60	Yes	427120	0.18
934-40001	711	2	24	Yes	427809	0.16	937-683020101	731	5	60	Yes	427137	0.16
934-402.501	711	2	24	Yes	427793	0.3	937-6930101	731	5	60	Yes	427113	0.14
934-40201	711	2	24	Yes	427786	0.2333	937-703020101	731	5	60	Yes	427106	0.11
934-40401	711	2	24	Yes	427762	0.5646	937-7130101	731	5	60	Yes	427090	0.18
935-02001	712	5	60	Yes	427694	0.0392	937-7230101	731	5	60	Yes	427083	0.15
935-022.501	712	5	20	Yes	427670	0.09	937-723030101	731	5	60	Yes	427076	0.1375
935-02301	712	5	20	Yes	427656	0.06	937-733020101	731	5	60	Yes	427069	0.12
935-02401	712	5	20	Yes	427649	0.11	937-7530101	731	5	40	Yes	427052	0.15
935-02501	712	5	60	Yes	427632	2.75	937-753030201	731	5	60	Yes	427045	0.19
935-02601	712	5	60	Yes	427625	0.1542	937-763002101	731	5	20	Yes	427038	0.0975
935-10001	712	5	60	Yes	427618	0.0492	937-763020101	731	5	60	Yes	427021	0.12
935-102.501	712	5	60	Yes	457011	0.1058	937-763020201	731	5	60	Yes	427007	0.1383
935-10201	712	5	60	Yes	427595	0.0808	937-773030101	732	5	40	Yes	426994	0.1
935-161.501	712	5	60	Yes	427540	0.0792	937-782030101	732	5	40	Yes	426987	0.1
935-162.501	712	5	20	Yes	456816	0.13	937-782530101	732	5	40	Yes	426970	0.14
935-16301	712	5	20	Yes	456922	2.95	937-783016201	732	5	60	Yes	426963	0.1
935-16501	712	5	60	Yes	427526	0.2783	937-783020201	732	5	40	Yes	426956	0.11
935-16601	712	5	60	Yes	456786	0.3342	937-793002201	732	5	60	Yes	426932	0.09
935-20001	712	5	60	Yes	427519	0.0858	937-803030201	731	5	20	Yes	426918	0.25
935-202.501	712	5	60	Yes	457073	0.1783	937-8520300201	732	5	40	Yes	502636	0.2675
935-30001	712	5	60	Yes	206435	0.1242	937-95301001	733	5	60	Yes	206121	0.1392
935-30301	712	5	60	Yes	457097	0.2792	937-96301001	733	5	60	Yes	206138	0.1158
935-40201	712	2	24	Yes	457059	0.2467	938-1230101	737	5	60	Yes	207326	0.055

Item No	Page No	Min Qty	Case Qty	UPC Bar-Coded	UPC 6-Digit	Weight (lbs.)	Item No	Page No	Min Qty	Case Qty	UPC Bar-Coded	UPC 6-Digit	Weight (lbs.)
938-4930101	738	5	60	Yes	426901	0.03	972-100	639	1	12	Yes	508959	0.1319
938-65303001	738	5	40	Yes	426888	0.03	972-15	639	1	50	No	508973	0.497
938-66302001	738	5	40	Yes	426840	0.1	972-20	639	1	50	No	508997	0.397
938-66302501	738	5	40	Yes	426826	0.04	972-30	639	1	50	No	509000	0.6816
938-673030101	737	5	60	Yes	426710	0.0492	972-32	639	1	18	Yes	566140	0.7917
938-683020101	737	5	60	Yes	426703	0.03	972-32RB	639	1	18	Yes	509239	0.8408
938-693030101	737	5	60	Yes	426727	0.04	972-32SN	639	1	18	Yes	509055	0.8396
938-713030101	737	5	60	Yes	207081	0.0417	972-35	639	1	50	No	509024	0.658
938-7530101	737	5	60	Yes	426697	0.0792	972-36	639	1	18	Yes	556806	0.9376
938-783010201	738	5	60	Yes	426796	0.0425	972-361PK2	639	6	6	Yes	501868	1.078
938-783016201	738	5	60	Yes	426789	0.04	972-362PK2	639	6	6	Yes	501875	1.044
938-783020201	738	5	60	Yes	426772	0.03	972-363PK2	639	6	6	Yes	738387	1.78
938-783025201	738	5	60	Yes	426765	0.04	972-36RB	639	1	18	Yes	509109	0.9161
958-44322001	692	1	1	No	426604	13.5	972-36SN	639	1	18	Yes	509123	0.8114
961-20	767	24	24	No	508584	0.1617	972-3RA	639	1	10	No	501837	0.3012
961-20155	624	1	25	Yes	508607	0.034	973-0010C01	602	8	8	Yes	426574	1.15
961-22	767	24	24	No	508645	0.196	973-0010PB04	602	4	4	Yes	426550	1.5
961-32	767	1	12	No	508669	0.2745	973-0010SN04	602	4	4	Yes	426543	1.45
961-34	767	1	12	No	508676	0.6495	973-0015C04	602	8	8	Yes	503138	1.4562
961-6	624	25	25	No	508690	0.062	973-0015RB04	602	1	8	Yes	503190	1.4625
961-7	624	25	25	No	508706	0.11	973-0102C04	603	1	12	Yes	426536	1.7625
963-01	775	24	240	No	508751	0.0338	973-0202C04	603	8	8	Yes	503251	-
963-05	775	5	5	Yes	508768	5.276	973-0302C04	603	1	8	Yes	426512	1.5
963-15PK2	775	20	20	Yes	517012	1.002	973-0402C04	603	8	8	Yes	472861	1.1
963-HTL-FE128	779	4	4	Yes	972249	15.225	973-0600C04	602	1	3	Yes	472878	3.6
963-HTL-FE20	779	12	12	Yes	137174	2.5208	973-0600SN/RB04	602	1	3	Yes	426505	3.6
963-HTL-FE32	779	12	12	Yes	922015	3.9375	973-1010SN04	602	4	4	Yes	426475	1.25
963-HTL-FE64	779	4	4	Yes	962028	7.95	973-2015C04	601	1	10	Yes	456366	3.845
965-204	768	25	25	No	508836	0.2	973-2302C04	601	1	12	Yes	456373	3.7542
965-208	768	25	25	No	508843	0.314	973-2439C04	601	10	10	Yes	736956	3.9062
965-212	768	25	25	No	508850	0.38	973-3015C04	601	1	16	Yes	426468	3.54
965-804	768	25	25	No	508867	0.252	973-3015PB04	601	1	16	Yes	426451	3.54
965-808	768	25	25	No	508874	0.416	973-3015SN04	601	1	4	Yes	207685	-
965-812	768	25	25	No	508881	0.424	973-3016C04	601	1	3	Yes	426444	4.18
969-014440304001	112	2	24	Yes	426581	0.55	973-3102C04	601	4	16	Yes	426437	3.37
970-112	221	20	20	Yes	302120	0.56	973-3302C04	601	1	12	Yes	456397	3.625
970-117	221	12	12	Yes	508911	1.392	973-3702C04	602	1	3	Yes	426413	3.5
970-208	221	1	12	Yes	302083	0.75	973-3900C04	602	1	10	Yes	426406	5.45
970-214	221	1	12	Yes	302144	1.767	973-5201C01	603	8	8	Yes	426390	1.3
970-214S	221	1	6	Yes	100702	1.775	973-5202C04	603	8	8	Yes	503206	1.3562
970-269S	221	1	6	Yes	100719	0.75	973-5401C04	603	1	12	Yes	426383	1.36
971-1414	151	1	1	No	101143	6.85	973-6101C01	603	8	8	Yes	426376	2.45
971-1414	221	1	1	No	101143	6.85	973-6301C04	603	8	8	Yes	426369	2.65
971-1430	151	1	1	No	101150	12.85	973-7201C01	603	8	8	Yes	426352	0.8
971-1430	221	1	1	No	101150	12.85	973-7401C04	603	1	12	Yes	207692	-
971-77	221	1	8	No	718761	-	973-8301C01	603	1	8	Yes	426345	1.7562
971-77	310	1	8	No	718761	-	973-8301PB04	603	4	4	Yes	426338	2.1375
971-99	221	1	8	No	718778	3.2	973-9000C01	604	1	25	Yes	426321	0.3
971-99	310	1	8	No	718778	3.2	973-9015R101	604	6	120	Yes	426314	0.1346
972-10	639	1	50	No	508942	0.394	973-9090C04	604	1	1	Yes	472892	0.29

Supply

Drainage

Support

Specialties

Appendix

# Numerical Index

Supply

Drainage

Support

Specialties

Appendix

Item No	Page No	Min Qty	Case Qty	UPC Bar-Coded	UPC 6-Digit	Weight (lbs.)	Item No	Page No	Min Qty	Case Qty	UPC Bar-Coded	UPC 6-Digit	Weight (lbs.)
973-9097C01	604	1	20	Yes	426307	1.305	975-20202001	687	5	20	Yes	425744	0.4275
973-9099C01	604	1	20	Yes	426291	0.0725	975-2110100201	687	5	60	Yes	425737	0.175
973-9100C04	604	1	12	Yes	472908	0.6292	975-2116161001	687	5	60	Yes	425713	0.2442
973-9300C04	604	1	12	Yes	456441	0.5042	975-2120201601	687	5	60	Yes	425706	0.3408
973-9392C04	604	10	200	Yes	426284	0.15	975-251001	688	5	40	Yes	425683	0.2
973-9601	604	1	25	Yes	472915	0.042	975-251601	688	5	40	Yes	425676	0.21
974-60100	604	1	20	Yes	509048	0.2925	975-27020001	689	10	40	Yes	425652	0.06
974-60101	604	1	10	Yes	472922	-	975-27020201	689	5	60	Yes	425645	0.105
974-60102	604	1	12	Yes	509062	0.192	975-27100201	689	5	20	Yes	425621	0.16
974-60116	604	12	120	No	509093	0.0549	975-27101601	689	5	60	Yes	425607	0.14
974-60300	641	1	6	Yes	509130	0.5823	975-27161001	689	5	40	Yes	425546	0.18
974-60306	640	1	25	Yes	509161	0.2651	975-27162001	689	5	40	Yes	425539	0.22
974-60308	640	1	25	Yes	509185	0.4074	975-27201601	689	5	20	Yes	425522	0.26
974-60315	640	1	10	Yes	509215	0.85	975-28102001	689	5	60	Yes	425577	0.19
974-660303L04	641	50	50	No	426277	0.479	975-31101001	689	5	20	Yes	425508	0.1575
974-662303L04	641	50	50	No	426260	0.56	975-31101601	689	5	60	Yes	425492	0.1767
974-6633032H04	641	1	1	Yes	426253	2.85	975-31161001	689	5	60	Yes	425485	0.1492
974-668303BH	641	1	1	Yes	502568	3.2	975-31201601	689	5	60	Yes	425454	0.2217
974-68000304	641	1	1	Yes	426246	3	975-40021001	688	5	40	Yes	425409	0.07
974-68100304	641	1	1	Yes	426239	4.7	975-40050001	688	5	60	Yes	425379	0.0675
974-68200301	641	1	4	Yes	426222	8.0125	975-40050201	688	5	60	Yes	425362	0.0733
974-686003C04	641	1	24	Yes	426215	2.3438	975-40100001	688	5	60	Yes	425355	0.0808
974-84410301	641	1	50	Yes	472939	-	975-40101601	688	5	60	Yes	425324	0.05
974-85033201	641	1	100	Yes	456519	0.08	975-40101605	688	5	60	Yes	425294	0.4633
974-95650004	627	1	12	Yes	456571	1.735	975-40162001	688	5	60	Yes	425263	0.1
974-95650304	627	1	12	Yes	456588	1.6958	975-40162501	688	5	60	Yes	425232	0.175
975-080201	690	5	60	Yes	426192	0.05	975-40252501	688	5	60	Yes	425188	0.07
975-080501	690	5	60	Yes	426185	0.07	975-41021601	688	5	60	Yes	425393	0.07
975-081001	690	10	120	Yes	426161	0.05	975-41101001	688	5	40	Yes	425300	0.05
975-081010	690	5	60	Yes	426154	0.41	975-41102001	688	10	120	Yes	425317	0.09
975-081601	690	5	60	Yes	426147	0.08	975-41161601	688	5	60	Yes	425270	0.12
975-082001	690	5	60	Yes	426123	0.12	975-41202001	688	5	60	Yes	425218	0.17
975-091001	690	5	60	Yes	426079	0.08	975-41203001	688	5	20	Yes	425195	0.22
975-091601	690	5	60	Yes	426055	0.11	975-44101601	688	5	60	Yes	425096	0.09
975-092001	690	5	60	Yes	426024	0.14	975-44102501	688	5	60	Yes	425072	0.1483
975-101001	690	10	120	Yes	425997	0.09	975-44161001	688	5	40	Yes	425065	0.11
975-101601	690	10	120	Yes	425980	0.13	975-44162001	688	5	60	Yes	425041	0.12
975-102001	690	10	120	Yes	425973	0.07	975-44162501	688	5	60	Yes	425027	0.1667
975-103001	687	2	24	Yes	425966	0.5958	975-442016	689	5	15	Yes	425010	0.6467
975-120201	687	5	20	Yes	425959	0.06	975-44202501	689	5	20	Yes	424990	0.18
975-121001	687	5	60	Yes	425928	0.11	975-44252501	689	5	60	Yes	424983	0.2567
975-121601	687	5	60	Yes	425904	0.15	975-45101001	688	5	20	Yes	425119	0.0825
975-122001	687	5	20	Yes	425881	0.2	975-45102001	688	10	120	Yes	425089	0.15
975-13100201	687	5	20	Yes	425874	0.0825	975-45202001	689	5	40	Yes	425003	0.1525
975-13161001	687	5	60	Yes	425867	0.12	975-46161601	687	5	40	Yes	424907	0.2
975-13201001	687	5	60	Yes	425843	0.1575	975-46202001	687	5	60	Yes	424891	0.25
975-13201601	687	5	60	Yes	425836	0.1592	975-490201	690	5	60	Yes	424884	0.05
975-200201	687	5	20	Yes	425829	0.095	975-490501	690	5	60	Yes	424877	0.05
975-201001	687	5	60	Yes	425812	0.2017	975-491001	690	5	60	Yes	424860	0.05
975-201601	687	5	60	Yes	425775	0.2583	975-491601	690	5	60	Yes	424853	0.07



Item No	Page No	Min Qty	Case Qty	UPC Bar-Coded	UPC 6-Digit	Weight (lbs.)	Item No	Page No	Min Qty	Case Qty	UPC Bar-Coded	UPC 6-Digit	Weight (lbs.)
975-492001	690	<b>5</b>	40	Yes	424846	0.11	<b>996-8S</b>	572	<b>100</b>	1000	No	702128	0.0061
975-510205	690	<b>5</b>	20	Yes	424839	0.05	<b>996-8S</b>	588	<b>100</b>	1000	No	702128	0.0061
975-511005	690	<b>5</b>	60	Yes	424815	0.07	<b>996-L100201</b>	697	<b>5</b>	60	Yes	206268	0.2575
975-511605	690	<b>5</b>	40	Yes	424808	0.07	<b>996-L101001</b>	697	<b>5</b>	60	Yes	206251	0.2442
975-512005	690	<b>5</b>	20	Yes	424792	0.17	<b>996-L601001</b>	722	<b>5</b>	60	Yes	206237	0.13
975-L541001	687	<b>5</b>	60	Yes	424938	0.14	<b>996-L601601</b>	722	<b>5</b>	60	Yes	206244	0.1442
978-081001	691	<b>5</b>	60	Yes	424723	0.05	<b>997-010201104001</b>	745	<b>5</b>	60	Yes	424457	0.1242
978-40102001	691	<b>5</b>	40	Yes	424679	0.11	<b>997-010206020601</b>	745	<b>5</b>	60	Yes	424419	0.1175
978-44101001	691	<b>5</b>	60	Yes	424662	0.065	<b>997-010206024001</b>	745	<b>5</b>	60	Yes	424402	0.0975
978-44101601	691	<b>5</b>	60	Yes	424655	0.09	<b>997-0102440244</b>	745	<b>5</b>	60	Yes	424389	0.1058
978-47021001	691	<b>5</b>	40	Yes	424648	0.07	<b>997-020201104001</b>	745	<b>5</b>	60	Yes	424280	0.1192
978-47101001	691	<b>5</b>	60	Yes	424631	0.07	<b>997-020206024001</b>	745	<b>5</b>	60	Yes	424273	0.1017
978-491001	691	<b>5</b>	60	Yes	424600	0.04	<b>997-0242020201</b>	745	<b>5</b>	60	Yes	424303	0.08
980-5	588	<b>50</b>	500	No	504531	0.0565	<b>997-400201</b>	745	<b>5</b>	60	Yes	424433	0.09
980-6	588	<b>50</b>	500	No	509260	0.0725	<b>997-401001</b>	745	<b>5</b>	60	Yes	424341	0.05
980-7	588	<b>10</b>	100	Yes	715708	0.135	<b>997-42020201</b>	745	<b>5</b>	40	Yes	424426	0.08
980-8	588	<b>50</b>	500	No	509277	0.079	<b>997-940201</b>	746	<b>5</b>	60	Yes	424228	0.2
981-5	588	<b>50</b>	500	No	509284	0.0595	<b>997-941001</b>	746	<b>5</b>	40	Yes	424204	0.25
981-6	588	<b>50</b>	500	No	509291	0.1025	<b>998-011044104001</b>	747	<b>5</b>	60	Yes	424143	0.2008
981-7	588	<b>10</b>	100	Yes	715715	0.145	<b>998-011048104801</b>	747	<b>5</b>	40	Yes	424129	0.32
981-8	588	<b>50</b>	500	No	502988	-	<b>998-05104001</b>	746	<b>5</b>	60	Yes	424051	0.08
985-5	588	<b>50</b>	500	No	509307	0.0542	<b>998-301001</b>	747	<b>5</b>	20	Yes	424167	0.17
985-6	588	<b>50</b>	500	No	509314	0.0625	<b>998-51102001</b>	747	<b>5</b>	20	Yes	424112	0.35
985-8	588	<b>50</b>	500	No	509321	0.0695	<b>998-51162001</b>	747	<b>5</b>	20	Yes	424099	0.3475
986-6	588	<b>50</b>	500	No	509338	0.0595	<b>999-211610V01</b>	746	<b>5</b>	60	Yes	424044	0.2067
988-5000	572	<b>100</b>	1000	No	456625	0.017	<b>999-56200201</b>	746	<b>5</b>	60	Yes	424037	0.1467
988-5100	572	<b>100</b>	1000	No	702081	-	<b>999-56300201</b>	746	<b>5</b>	60	Yes	424020	0.2342
988-6	572	<b>100</b>	1000	No	509345	0.0235							
988-6100	572	<b>100</b>	1000	No	456632	0.02							
988-6GT	471	<b>25</b>	25	No	713827	0.042							
988-6GT	473	<b>25</b>	25	No	713827	0.042							
988-6GT	570	<b>25</b>	25	No	713827	0.042							
988-6GT	572	<b>25</b>	25	No	713827	0.042							
990-20385	588	<b>25</b>	300	No	509352	0.0095							
990-7	588	<b>100</b>	1000	No	509376	0.0086							
991-6	572	<b>100</b>	1000	No	509383	0.0058							
991-6S	572	<b>100</b>	1000	No	702098	0.0056							
991-6S	588	<b>100</b>	1000	No	702098	0.0056							
995-20320	588	<b>25</b>	200	No	509390	0.0097							
995-20330	588	<b>25</b>	200	No	509406	0.0111							
995-5	588	<b>100</b>	1000	No	509437	0.006							
995-6	588	<b>100</b>	1000	No	509444	0.0106							
995-8	588	<b>100</b>	1000	No	509451	0.0125							
996-500	572	<b>100</b>	1000	No	456649	0.0035							
996-5S	572	<b>100</b>	1000	No	702104	0.0034							
996-5S	588	<b>100</b>	1000	No	702104	0.0034							
996-6	572	<b>100</b>	1000	No	509468	0.0058							
996-6S	572	<b>100</b>	1000	No	702111	0.004							
996-6S	588	<b>100</b>	1000	No	702111	0.004							
996-8	572	<b>100</b>	1000	No	509475	0.0078							

Supply

Drainage

Support

Specialties

Appendix



DATE		
PAGE	OF	

### INSTRUCTIONS

1. Fill in all Bill to and Ship to information.
2. Complete one line for each item ordered and fully extend for item total. Add all lines for order total.
3. Fax or mail page(s) to factory, representative or wholesaler.

#### BILL TO

 new address

Qualified wholesale distributors only		
Purchase order no.		
Contact name		
Company		
Street address		
City		
State	Zip	
Phone	Fax	
Special instructions		

#### SHIP TO

 new address

Leave blank if same as "bill to"		
Purchase order no.		
Contact name		
Company		
Street address		
City		
State	Zip	
Phone	Fax	
Special instructions		

### ORDER

	Item No.	Description	Qty.	List Price Each	List Price Total	Mult.	Net Price Total
	1						
	2						
	3						
	4						
	5						
	6						
	7						
	8						
	9						
	10						
	11						
	12						
	13						
	14						
	15						
Signature / Date			Order Totals				

[www.siouxchief.com](http://www.siouxchief.com)

14940 Thunderbird Road  
 Kansas City, MO 64147  
**P** 1.800.821.3944  
**F** 1.800.758.5950



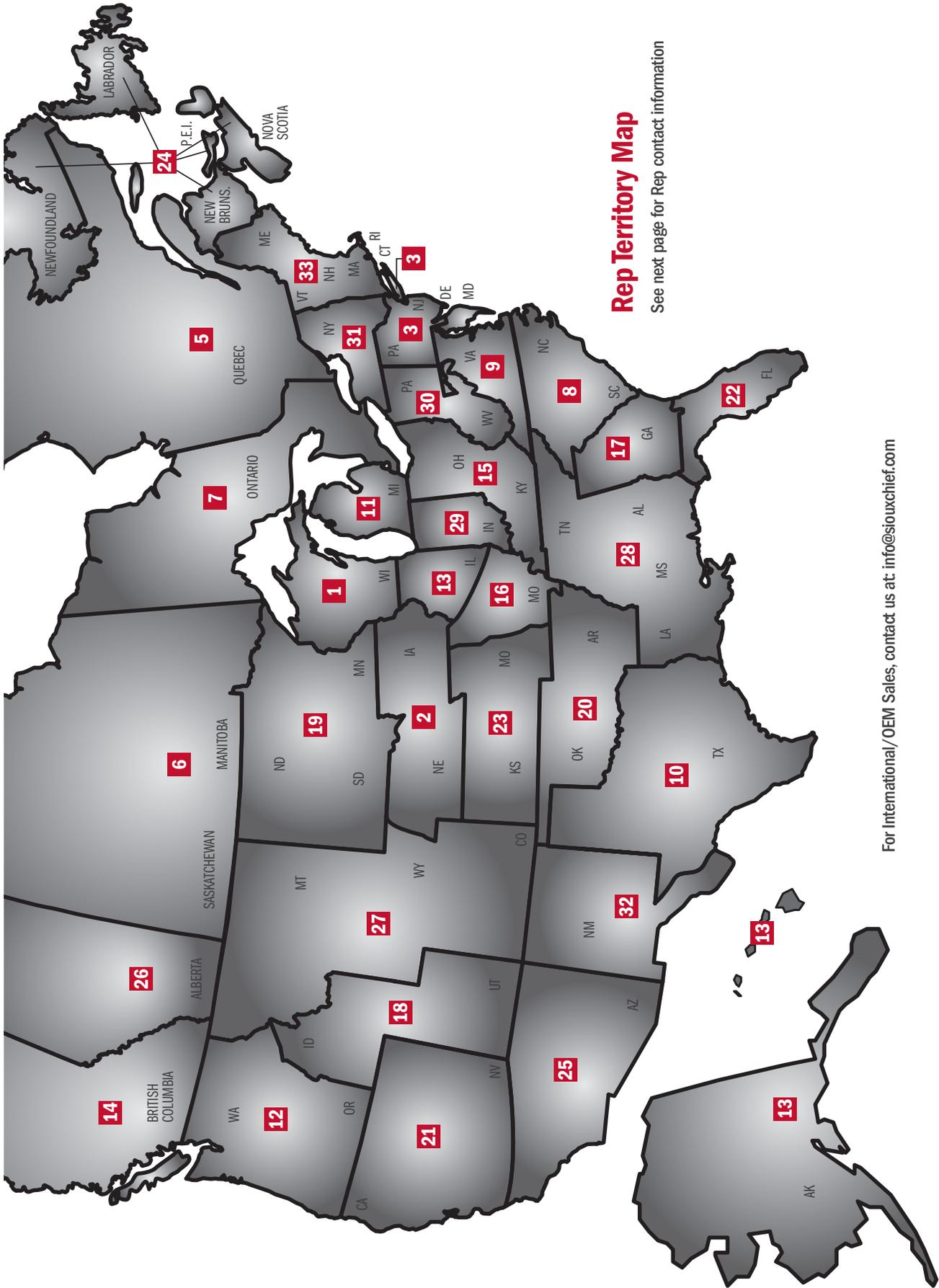

**Rep Territory Map**

See next page for Rep contact information

For International/OEM Sales, contact us at: [info@siouxchief.com](mailto:info@siouxchief.com)

Company	Territory	Phone	Website
1 Badgerland Trading Company	WI	(262) 827-3177	badgerlandtrading.com
2 Bulls-I Sales	IA, NE	(913) 649-8391	bullsisales.com
3 Burns Cope Associates	Northern DE, NJ, Eastern PA, New York Metro Area	(610) 485-2828	burnscope.com
4 C R G International Corp	Puerto Rico	(787) 796-2999	josereliablesales@gmail.com
5 Can-Aqua International	Quebec	(450) 625-3088	can-aqua.ca
6 Can-Aqua International	Saskatchewan Manitoba	(306) 501-4295 (204) 292-9749	can-aqua.ca
7 Cardinal Sales	Ontario	(905) 569-1419	cardinalsales.ca
8 Carolina Sales Associates	NC, SC	(803) 831-7227	csareps.com
9 Cathell & Associates	Southern DE, DC, MD, VA, WV	(571) 313-1390	cathell.com
10 Corbett, Wingard & Ray	TX	(817) 335-4802	www.cwrrepstexas.com
11 Exceptional Product Sales	MI	(586) 286-3240	eps.michigan@sbcglobal.net
12 Gordon & Associates	AK, WA, OR, HI	(360) 566-1470	gordonandassoc.com
13 Hart, Travers & Associates	IL	(800) 535-8525	htareps.com
14 Hy-Line Sales	British Columbia	(778) 657-6431	hylinesales.com
15 Lowder Sales	OH, KY	(800) 221-5650	lsireps.com
16 M R & Associates	Eastern MO & Southern IL	(314) 962-8960	mrsassocinc.com
17 McKee-Nix & Associates	GA	(770) 934-8061	mckeenix.com
18 Mountain West Marketing	UT, ID	(801) 782-0100	mtnwm.com
19 Northland Reps	ND, SD, MN	(952) 854-3905	northlandreps.com
20 NSC Marketing	OK, AR	(405) 602-2800	nscok.com
21 Paramount Sales	Northern CA, NV	(925) 373-0817	paramountsales.biz
22 RSL Sales Associates	FL	(800) 538-4792	rsales.com
23 SFE Enterprises	KS, MO	(816) 322-2206	sfeenterprises.com
24 Shoreline Mechanical Sales	Atlantic Canada	(902) 455-2939	shorelinemechanical.ca
25 Signature Sales	Southern CA, AZ, Las Vegas, NV	(951) 549-1000	signaturesalesinc.com
26 Spectrum Sales	Alberta	(403) 255-8332	spectrumsales.ca
27 T M Sales	MT, WY, CO, Western NE	(303) 375-1515	tmsalesinc.com
28 Tim Morales & Associates	LA, AL, MS, TN, FL panhandle	(251) 602-8333	timmorales.com
29 TOP Marketing	Indiana	(317) 575-9267	topmktg.com
30 Triumph Sales	Western PA, WV	(412) 781-0950	triumphsalesinc.com
31 Twin "D" Associates	NY	(800) 522-3523	twindassociates.com
32 W W Sales Company	NM, El Paso, TX	(505) 878-0636	wwsalesco.com
33 Walter F Morris Company	New England	(800) 888-1922	morrismerchants.com

# General Reference

Supply

- 1 cubic ft of water weighs 62.41 lbs.
- 1 cubic meter of water weighs 100 kg.
- 1 gallon (US) of water weighs 8.335 lbs.
- 1 liter of water weighs 1 kg.

Copper water tube and copper sweat fittings are referenced by their nominal (nom) size, which approximates the inside diameter (I.D.) waterway of the tube (1/2" nom, 3/4" nom, etc.).

Drainage

Compression fittings are referenced by the outside diameter (O.D.) of the tube they connect to (5/8" O.D., 7/8" O.D., etc.).

Copper water tube is manufactured in accordance with ASTM Standard B 88.

Support

Nominal Tube Size	Outside Diameter	Min. Wall Thickness	Weight Empty (lbs/ft)	Weight Full of Water (lbs/ft)
<b>SCHEDULE 40 STEEL</b>				
1/8"	0.405"	0.068"	0.2	0.4
1/4"	0.540"	0.088"	0.4	0.5
3/8"	0.675"	0.091"	0.6	0.7
1/2"	0.840"	0.109"	0.8	0.9
3/4"	1.050"	0.113"	1.1	1.3
1"	1.315"	0.133"	1.7	2.1
1 1/4"	1.660"	0.140"	2.3	2.9
1 1/2"	1.900"	0.145"	2.7	3.6
2"	2.375"	0.154"	3.6	5.0
2 1/2"	2.875"	0.203"	5.8	7.9
3"	3.500"	0.216"	7.6	10.8
3 1/2"	4.000"	0.226"	9.1	13.4
4"	4.500"	0.237"	10.8	16.3
<b>SCHEDULE 40 PVC</b>				
1/8"	0.405"	0.068"	0.04	0.06
1/4"	0.540"	0.088"	0.07	0.11
3/8"	0.675"	0.091"	0.10	0.18
1/2"	0.840"	0.109"	0.15	0.25
3/4"	1.050"	0.113"	0.20	0.40
1"	1.315"	0.133"	0.30	0.70
1 1/4"	1.660"	0.140"	0.40	1.00
1 1/2"	1.900"	0.145"	0.50	1.40
2"	2.375"	0.154"	0.60	2.00
2 1/2"	2.875"	0.230"	1.00	3.10
3"	3.500"	0.216"	1.30	4.50
3 1/2"	4.000"	0.226"	1.60	5.90
4"	4.500"	0.237"	1.90	7.40
<b>SCHEDULE 40 CPVC</b>				
1/4"	0.540"	0.088"	0.09	0.12
1/2"	0.840"	0.109"	0.19	0.28
3/4"	1.050"	0.113"	0.25	0.43
1"	1.315"	0.133"	0.38	0.76
1 1/4"	1.660"	0.140"	0.51	1.08
1 1/2"	1.900"	0.145"	0.61	1.49
2"	2.375"	0.154"	0.82	2.12
2 1/2"	2.875"	0.230"	1.29	3.29
3"	3.500"	0.216"	1.69	4.75
4"	4.500"	0.237"	2.33	7.68

Specialties

Appendix

Nominal Tube Size	Outside Diameter	Min. Wall Thickness	Weight Empty (lbs/ft)	Weight Full of Water (lbs/ft)
<b>SCHEDULE 80 STEEL</b>				
1/8"	0.405"	0.095"	0.3	0.4
1/4"	0.540"	0.119"	0.5	0.6
3/8"	0.675"	0.126"	0.7	0.8
1/2"	0.840"	0.147"	1.1	1.2
3/4"	1.050"	0.154"	1.5	1.7
1"	1.315"	0.179"	2.2	2.5
1 1/4"	1.660"	0.191"	3.0	3.5
1 1/2"	1.900"	0.200"	3.6	4.3
2"	2.375"	0.218"	5.0	6.3
2 1/2"	2.875"	0.276"	7.6	9.4
3"	3.500"	0.300"	10.2	13.0
3 1/2"	4.000"	0.318"	12.5	16.3
4"	4.500"	0.337"	15.0	20.0
<b>SCHEDULE 80 POLYPRO</b>				
1/2"	0.840"	0.147"	0.14	0.19
3/4"	1.050"	0.154"	0.19	0.33
1"	1.315"	0.179"	0.27	0.49
1 1/4"	1.660"	0.191"	0.38	0.85
1 1/2"	1.900"	0.200"	0.45	1.18
2"	2.375"	0.218"	0.62	1.61
<b>SCHEDULE 80 PVC</b>				
1/8"	0.405"	0.095"	0.05	0.06
1/4"	0.540"	0.119"	0.09	0.12
3/8"	0.675"	0.126"	0.10	0.16
1/2"	0.840"	0.147"	0.10	0.20
3/4"	1.050"	0.154"	0.20	0.40
1"	1.315"	0.179"	0.40	0.70
1 1/4"	1.660"	0.191"	0.50	1.00
1 1/2"	1.900"	0.200"	0.60	1.30
2"	2.375"	0.218"	0.90	2.20
2 1/2"	2.875"	0.276"	1.30	3.10
3"	3.500"	0.300"	1.80	4.60
3 1/2"	4.000"	0.318"	2.20	6.00
4"	4.500"	0.337"	2.60	7.60
<b>SCHEDULE 80 CPVC</b>				
1/4"	0.540"	0.119"	0.12	0.16
1/2"	0.840"	0.147"	0.24	0.31
3/4"	1.050"	0.154"	0.33	0.48
1"	1.315"	0.179"	0.49	0.85
1 1/4"	1.660"	0.191"	0.67	1.18
1 1/2"	1.900"	0.200"	0.81	1.61
2"	2.375"	0.218"	1.09	2.26
2 1/2"	2.875"	0.276"	1.65	3.49
3"	3.500"	0.300"	2.21	5.02
4"	4.500"	0.337"	3.23	8.08
<b>CTS CPVC (SDR 11)</b>				
1/2"	0.625"	0.060"	0.08	0.16
3/4"	0.875"	0.080"	0.14	0.31
1"	1.125"	0.102"	0.22	0.51
1 1/4"	1.375"	0.125"	0.33	0.76
1 1/2"	1.625"	0.148"	0.47	1.07
2"	2.125"	0.193"	0.80	1.83

Nominal Tube Size	Outside Diameter	Min. Wall Thickness	Weight Empty (lbs/ft)	Weight Full of Water (lbs/ft)
<b>COPPER TYPE K</b>				
3/8"	0.500"	0.049"	0.27	0.32
1/2"	0.625"	0.049"	0.34	0.43
5/8"	0.750"	0.049"	0.42	0.56
3/4"	0.875"	0.065"	0.64	0.83
1"	1.125"	0.065"	0.84	1.18
1 1/4"	1.375"	0.065"	1.04	1.57
1 1/2"	1.625"	0.072"	1.36	2.10
2"	2.125"	0.083"	2.06	3.37
2 1/2"	2.625"	0.095"	2.92	4.92
3"	3.125"	0.109"	4.00	6.96
3 1/2"	3.625"	0.120"	5.12	9.02
4"	4.125"	0.134"	6.51	11.57
<b>COPPER TYPE L</b>				
3/8"	0.500"	0.035"	0.20	0.26
1/2"	0.625"	0.040"	0.28	0.38
5/8"	0.750"	0.042"	0.36	0.51
3/4"	0.875"	0.045"	0.45	0.66
1"	1.125"	0.050"	0.65	1.01
1 1/4"	1.375"	0.055"	0.88	1.42
1 1/2"	1.625"	0.060"	1.14	1.91
2"	2.125"	0.070"	1.75	3.09
2 1/2"	2.625"	0.080"	2.48	4.54
3"	3.125"	0.090"	3.33	6.28
3 1/2"	3.625"	0.100"	4.29	8.28
4"	4.125"	0.110"	5.38	10.57
<b>COPPER TYPE M</b>				
1/2"	0.625"	0.028"	0.204	0.314
3/4"	0.875"	0.032"	0.328	0.551
1"	1.125"	0.035"	0.465	0.843
1 1/4"	1.375"	0.042"	0.682	1.25
1 1/2"	1.625"	0.049"	0.940	1.73
2"	2.125"	0.058"	1.460	2.83
2 1/2"	2.625"	0.065"	2.030	4.14
3"	3.125"	0.072"	2.680	5.70
3 1/2"	3.625"	0.083"	3.580	7.64
4"	4.125"	0.095"	4.660	9.83
<b>COPPER TYPE DWV</b>				
1 1/4"	1.375"	0.040"	0.65	1.22
1 1/2"	1.625"	0.042"	0.81	1.62
2"	2.125"	0.042"	1.07	2.48
3"	3.125"	0.045"	1.69	4.81
4"	4.125"	0.058"	2.87	7.88
<b>CAST IRON EXTRA HEAVY</b>				
2"	2.38"	0.190"	5.0	6.6
3"	3.50"	0.250"	9.0	12.7
4"	4.50"	0.250"	12.0	18.5
<b>CAST IRON SERVICE WEIGHT</b>				
2"	2.25"	0.17"	4	5.5
3"	3.25"	0.17"	6	9.4
4"	4.25"	0.18"	8	14.2
<b>NO-HUB CAST IRON</b>				
1 1/2"	1.90"	0.16"	2.7	6.2
2"	2.35"	0.16"	3.6	8.6
3"	3.35"	0.16"	5.2	13.5
4"	4.38"	0.19"	7.4	20.2

**Pipe Support Requirements**

Data from 2021 International Plumbing Code, Table 308.5

Piping Material	Maximum Horizontal Spacing (ft)	Maximum Vertical Spacing (ft)
ABS pipe	4	10 <sup>B</sup>
Aluminum tubing	10	15
Brass pipe	10	10
Cast iron pipe	5 <sup>A</sup>	15
CPVC pipe or tubing, ≤ 1"	3	10 <sup>B</sup>
CPVC pipe or tubing, ≥ 1 1/4"	4	10 <sup>B</sup>
Copper or copper-alloy pipe	12	10
Copper or copper alloy tubing ≤ 1 1/4" diameter	6	10
Copper or copper alloy tubing ≥ 1 1/2" diameter	10	10
PEX pipe, ≤ 1"	2.67 (32")	10 <sup>B</sup>
PEX pipe, ≥ 1 1/4"	4	10 <sup>B</sup>
PEX-AL-PEX pipe	2.67 (32")	4
Lead pipe	Continuous	4
PE-AL-PE pipe	2.67 (32")	4
PE-RT pipe, ≤ 1"	2.67 (32")	10 <sup>B</sup>
PE-RT pipe, ≥ 1 1/4"	4	10 <sup>B</sup>
PP pipe or tubing, ≤ 1"	2.67 (32")	10 <sup>B</sup>
PP pipe or tubing, ≥ 1 1/4"	4	10 <sup>B</sup>
PVC pipe	4	10 <sup>B</sup>
Stainless steel drainage systems	10	10 <sup>B</sup>
Steel pipe	12	15

A: The maximum horizontal spacing of cast iron pipe hangers shall be increased to 10 ft where 10-ft lengths of pipe are installed  
 B: For sizes 2" and smaller, a guide shall be installed midway between required vertical supports. Such guides shall prevent pipe movement in a direction perpendicular to the axis of the pipe

**Labor Cost Chart**

Dollars earned when you save time using Sioux Chief products.

Rate	Time				
	2 min.	5 min.	10 min.	15 min.	20 min.
\$20.00/hr	\$0.66	\$1.67	\$3.33	\$5.00	\$6.67
\$25.00/hr	\$0.83	\$2.08	\$4.17	\$6.25	\$8.33
\$30.00/hr	\$1.00	\$2.50	\$5.00	\$7.50	\$10.00
\$35.00/hr	\$1.17	\$2.92	\$5.83	\$8.75	\$11.67
\$40.00/hr	\$1.33	\$3.33	\$6.67	\$10.00	\$13.33
\$45.00/hr	\$1.50	\$3.75	\$7.50	\$11.25	\$15.00
\$50.00/hr	\$1.67	\$4.17	\$8.33	\$12.50	\$16.67
\$55.00/hr	\$1.83	\$4.58	\$9.17	\$13.75	\$18.33
\$60.00/hr	\$2.00	\$5.00	\$10.00	\$15.00	\$20.00
\$65.00/hr	\$2.17	\$5.42	\$10.83	\$16.25	\$21.67
\$70.00/hr	\$2.33	\$5.83	\$11.67	\$17.50	\$23.33
\$75.00/hr	\$2.50	\$6.25	\$12.50	\$18.75	\$25.00

# Sioux Chief Manufacturing

## ▶▶ Limited Lifetime Warranty

Supply

Drainage

Support

Specialties

Appendix

### Warranty

Sioux Chief Mfg. Co., Inc. ("Seller" or "the Seller") warrants its products to be free from defects in material and workmanship under normal usage for the lifetime of the plumbing system in which they were originally incorporated. In the event of such defects within the warranty period, the Company will, at its option, replace or recondition the product without charge. This remedy shall be effective only if the product was installed in accordance with supplied instructions, common installation or use practices and existing building and plumbing codes and legal requirements; has not been subjected to misuse or abuse; was at all times used in a manner consistent with its intended use; was at all times used in installations and environments acceptable to its material and design specifications; or any express conditions or requirements laid out in company installation instructions, manuals, tech bulletins, special labeling, precautions, as well as other instructional documents and product limitations of use; was never modified, altered or repaired by anyone other than the Seller; was properly subjected to and passed common testing methods (including pressure testing for potable water and drainage systems) immediately after the product's installation and before the product is put into service, was not damaged by freezing temperatures or excessive heats outside normal working or any express working range of the product; was not subjected to or exposed to direct or indirect chemical exposures; was not subjected to corrosion from atmospheric or environmental degradation (including UV exposure, brackish water, acidic water (pH <6.5), alkaline water (pH >8), contaminated soils, etc.), and was protected from natural causes; was never subjected to improper protection during installation and was handled with all precautions expressly written within company limitation documents or known to the industry; was not subjected to water pressures and flow conditions outside the working limits of the product; was not subject to adverse or aggressive water conditions (during testing, through stagnation or within service life (where service-life is defined by this warranty)) and where any express water condition included within company documents is avoided; and all handling was performed in a manner consistent and known to the industry or taught through company documents, labels, websites, manuals, etc. In addition, Seller shall not be responsible for any incidental, special or consequential damages, including without limitation, lost profits or the cost of repairing or replacing other property which is damaged, other costs resulting from labor charges, delays, vandalism, negligence, fouling caused by foreign material, chemical or any other circumstances over which the Seller has no control. This warranty excludes all costs arising from routine maintenance, including the replacement of any parts required by such maintenance and the replacement of parts required by normal wear and tear. The Seller also reserves the right to modify, alter or improve its product, or parts thereof, at any time without incurring an obligation to notify or modify, alter, improve or replace any product, or parts thereof, previously sold. If, on any occasion, Seller waives any term or condition, this waiver is not to be construed as a continuing waiver. For the purposes of this warranty, the lifetime of the original plumbing system is defined as the lesser of 25 years or the time before the plumbing system was replaced or materially changed; all products with automatically or manually moving parts are excluded from the limited lifetime warranty and carry a 3-year limited warranty, subject to the remaining terms, conditions and limitations of the warranty. Some States do not allow or have other parameters governing limitations on how long an implied warranty lasts, and some States do not allow the exclusion or limitation of incidental or consequential damages. This Limited Warranty gives you specific legal rights, and you may have other rights that vary from State to State. You should consult applicable state laws to determine your rights. THE WARRANTY SET FORTH HEREIN ABOVE AND BELOW IS GIVEN EXPRESSLY AND IS THE ONLY WARRANTY GIVEN BY THE COMPANY WITH RESPECT TO THE PRODUCT. THE COMPANY MAKES NO OTHER WARRANTIES, EXPRESS OR IMPLIED. THE COMPANY HEREBY SPECIFICALLY DISCLAIMS ALL OTHER WARRANTIES, EXPRESS OR IMPLIED, INCLUDING BUT NOT LIMITED TO THE IMPLIED WARRANTIES OF MERCHANTABILITY AND FITNESS FOR A PARTICULAR PURPOSE.

### Terms & Conditions

All sales are subject to the Standard Terms and Conditions set forth on Sioux Chief's website at [www.siouxchief.com](http://www.siouxchief.com). These terms include the following:

#### Return Merchandise

No merchandise can be returned without Seller's prior written authorization. All returns must comply with the guidelines established below.

#### Return Merchandise & Warranty Service

In order to return product/merchandise or receive warranty service, Buyer must first obtain a Return Merchandise Authorization ("RMA") by contacting Seller using the following information:

**MAIL:** Customer Service Manager  
Sioux Chief Manufacturing Company, Inc.  
14940 Thunderbird Road  
Kansas City, Missouri 64147  
**PHONE:** 816-425-9900 / 1-800-821-3944  
**FAX:** 816-348-7502 / 1-800-758-5950  
**EMAIL:** [info@siouxchief.com](mailto:info@siouxchief.com)

#### Return Merchandise Procedure

All merchandise returns and warranty claims are subject to the following general terms and conditions:

RMA requests must reference Seller's order number, invoice number or the customer's P.O. number.

Minimum return amount must be \$250 net value per purchase order.

Product returns can only be made within twelve (12) months of the original invoice date of the product to Buyer.

Seller reserves the right, at its sole and absolute discretion, to reject an RMA request for any reason at any time.

In order to be received and accepted by Seller, all returned product must be in whole multiples of the Minimum Quantity listed in the current Price Index and material must be in its original packaging with manufacturer's seal intact.

Products which are being phased-out, are obsolete, or were special-order (custom) are not considered normal stock. These items are non-returnable and non-refundable, except in the case of a manufacturer's defect.

Buyer will be charged 25% of the applicable return price for product restocking. For Drainage items having one or more listed option, Buyer will be charged 33% of the applicable return price for product restocking, and will apply to canceled orders that have been entered but not shipped.

An RMA is invalid 90 days after its date of issue.

Seller will only supply product credit for a product return or warranty claim. Issuance of an RMA does not authorize the Buyer to deduct the value of the returned item; once product is received and accepted by Seller, Seller will issue a credit memo for the returned product when applicable.

All product returns are subject to inspection and acceptance by Seller at its discretion.

Seller reserves the right to deny, nullify or cancel an RMA at its discretion.

Product returned without a Return Merchandise Authorization number will be destroyed without credit.

Seller shall not be responsible for shipping errors and shortages reported 5 days after receipt of material.

Seller shall not be responsible for shipment shortages that are signed for as clear. Any shipment that appears to be damaged in shipping must be noted when signing for receipt of delivery.

#### Full Freight Allowance

Sioux Chief will pay freight on all orders to single destinations totaling at least \$4,000 Net to locations within the 48 contiguous states (United States of America), at least \$7,500 Net to locations within Hawaii, Alaska, and Puerto Rico, and at least \$3,500 CAD Net to locations within Canada. Sioux Chief will pay freight on HydroTec™ and HydroBlock™ trench drain orders of at least \$5,000 Net to locations with the 48 contiguous states.

### Warranty Procedure - Product & Property

All claims for property or other damage are subject to the following additional terms and procedure:

If there is a warranty claim on a part that involves property or other damage, Seller should be contacted by phone or in writing directly following the loss, and in no case later than 15 days of the date of alleged claim or failure and before any remediation or alteration of the loss site has been started; any notice beyond this time frame or after work has taken place to repair or change the loss site will materially affect the Seller's ability to adjudicate the claim and will void the warranty.

The product in claim and/or its installation should not be modified before review by Seller; alteration of the alleged product or installation materially affects the Seller's ability to establish fault and voids the warranty.

Request a claim form. Submit the completed form to the Seller. Claimant will receive an INC (incident) number from Seller.

With the INC number, claimant should submit the claim form, including the date of the installation, description of problem, damage, pictures of the product, and repair invoices. This information should be sent to the above address at claimant's expense. Seller will not receive or process a claim without an INC number.

Seller will contact claimant with next steps, which may include a visit from a site investigator or other representatives of Seller, as Seller reserves the right to investigate all alleged loss sites.

### Processing of Orders

All orders are processed immediately upon receipt and acceptance by Seller. Seller reserves the right to charge back to Buyer costs incurred from order cancellations or changes, and to consider additions as separate orders.

Unless provided in writing by Seller, any dates and/or times quoted by Seller for the delivery of any goods or the performance of any services are estimates and Seller will not be held responsible for any delay. Buyer's receipt of goods or acceptance of services shall constitute a waiver of any claim for delay.

If Buyer requires expedited shipment of "in stock" goods prior to stated lead times on said order, Buyer will be charged \$100.00 (USD) for any 'expedited' shipping on items up to \$1,000.00 (USD) net, and \$100.00 (USD) + 2% of net for any 'expedited' shipping on items over \$1,000.00 (USD) net.

### Price Changes

All prices quoted from time to time by Seller are subject to change without notice up to time of shipment. Invoice totals and discounts will be calculated out to the sixth decimal digit.

If Buyer fails to give written notice of objection to Sioux Chief's order confirmation within ten (10) days after Buyer's receipt of Sioux Chief's confirmation of the purchase order, the order confirmation pricing becomes binding.

### Minimum Order Quantities

A 20% surcharge will be applied to any item not purchased in multiples of the stated Minimum Quantity, except on drop-ship orders.

Items with bold Minimum Quantities in the Numerical Index (back of catalog) can never be broken.

PEX tube bundles (sticks) may only be included on orders of \$40,000 Net or more. In addition, PEX tube bundles (sticks) must also be ordered in a minimum quantity of ten (10) or a \$100 surcharge will apply to the line item. Coils may be ordered in any quantity, and on orders of any amount.



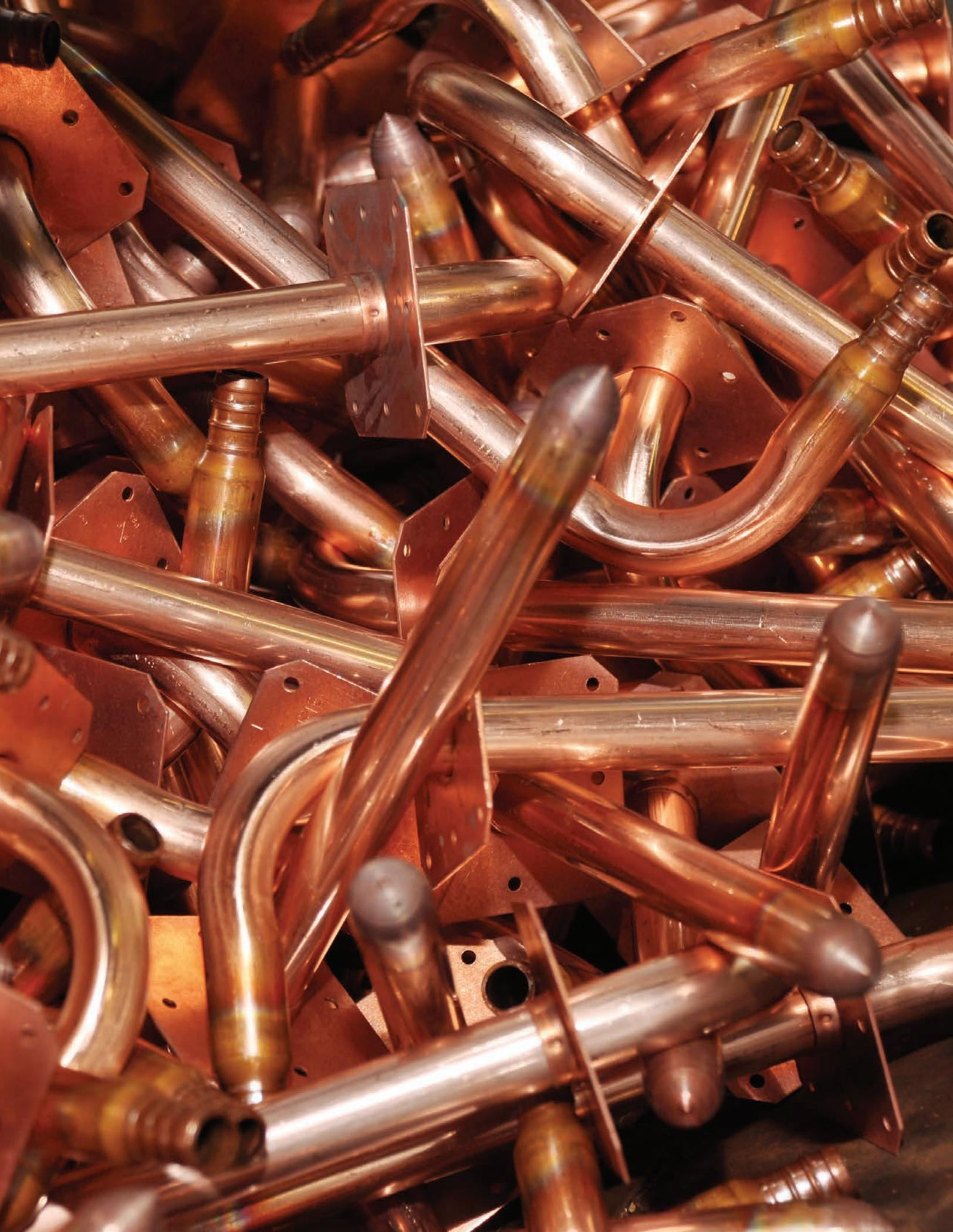

# TAKE THE FIELD.

**Sioux Chief Manufacturing Company, Inc.**

14940 Thunderbird Road

Kansas City, Missouri 64147

P 1-800-821-3944 | 816-425-9900

F 1-800-758-5950 | 816-348-7502

[www.siouxchief.com](http://www.siouxchief.com)

© 2022 Sioux Chief Manufacturing Company Inc.

**Online Pricing Guide**

Check up-to-date list prices anytime



<https://products.siouxchief.com>